

13. Doors & Windows

SECTION AT A GLANCE:

Door Handles	608
Door Locks	612
Door Latches	614
Door Lock Related	613
Door Lock Knobs	616
Door Hinge & Related	617
Flippers	618
Door Trim	620
Keyless Entry	621
Window Regulators	622
Power Window	623
Moulding Clips	625
Fur Channel	626
Windshield Moulding	628
Wiper Arms	632
Wiper Kits & Related	634
Glass Channels	635
Quarter Window & Related	638
Vent Window & Related	640
Seals	643
Nomad Trim	646
Liftgate	648
Tailgate	650
Screws & Fasteners	654
Window Glass Sets	655



EDDIE MOTORSPORTS BILLET OUTSIDE DOOR HANDLES
 1955-57 Polished, Sedan, Wagon, Nomad, 4-Door Hardtop #17171 \$315.95/pr.
 1955-57 Satin, Sedan, Wagon, Nomad, 4-Door Hardtop #17172 \$315.95/pr.



DOOR HANDLE GUARDS 
 Protect your paint with these beautifully die-cast and triple-chrome plated accessories. Reproduced to the original specifications, these guards will add brilliant detail to your car. Our #369 and #370 are the "Best" American versions, while the #V369 is a truly very good American version. Mounting screws included. **Made in the USA***.

1955-56 Best.....	#369*	\$54.95/pr.
1955-56 Good.....	#V369*	\$54.95/pr.
1955-56 Import.....	#16700.....	\$28.95/pr.
1957 Best.....	#370*	\$54.95/pr.
1957 Good.....	#16701.....	\$35.95/pr.



POLISHED BILLET ALUMINUM WINDOW HANDLES
 1955-57 #10454..... \$119.95/pr.



POLISHED BILLET ALUMINUM INSIDE DOOR HANDLES
 1955-57 #10452..... \$109.95/pr.



POLISHED BILLET ALUMINUM VENT HANDLES
 1955-57 #10453..... \$114.95/pr.



OUTSIDE DOOR HANDLE GASKETS 
 1955-57 #81807 \$5.50/pr.



DECK HANDLE GASKET
 We produce this unique gasket specifically for the sedan delivery and wagon.
 1955-57 #848..... \$2.95/ea.



PAINT GASKETS 
 Kit includes gaskets for door handles, door and trunk lock tumblers, antenna, and outside rear view mirror. **Made in the USA.**

1955-57 2-Door	#395.....	\$9.95/set
1955-57 4-Door (Shown)	#395A.....	\$11.95/set

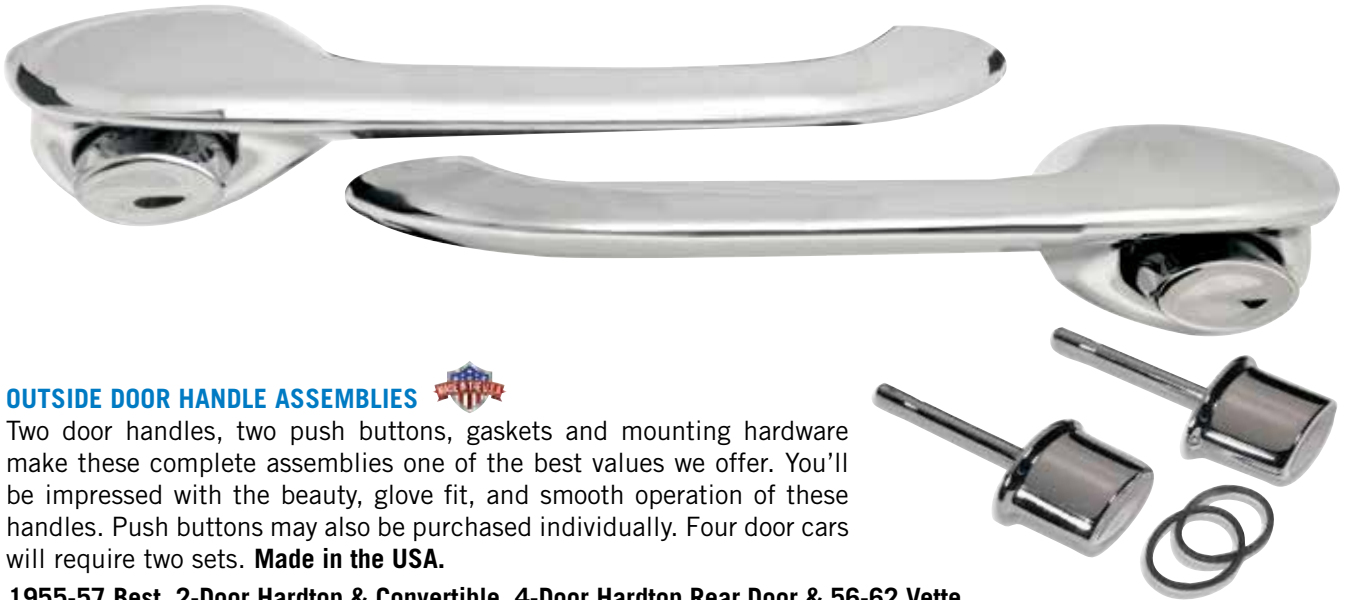

OUTSIDE DOOR HANDLE ASSEMBLIES



Two door handles, two push buttons, gaskets and mounting hardware make these complete assemblies one of the best values we offer. You'll be impressed with the beauty, glove fit, and smooth operation of these handles. Push buttons may also be purchased individually. Four door cars will require two sets. **Made in the USA.**

1955-57 Best, 2-Door Hardtop & Convertible, 4-Door Hardtop Rear Door & 56-62 Vette	#794	\$99.95/set
1955-57 Good, 2-Door Hardtop & Convertible, 4-Door Hardtop Rear Door & 56-62 Vette	#16716	\$65.95/set
1955-57 Best, Sedan, Nomad, Wagon & 4-Door Hardtop Front Door	#794A	\$99.95/set
1955-57 Good, Sedan, Nomad, Wagon & 4-Door Hardtop Front Door	#16750	\$74.95/set
1955-57 Push Buttons Only	#359	\$29.95/pr.

INSIDE DOOR HANDLES

This is one super quality reproduction, complete with the original groove details and brilliant plating. Includes plastic washers and mounting clips.



1955-57 Best	#367	\$34.95/pr.
1955-57 Good	#16741	\$17.95/pr.



WINDOW CRANK HANDLES

We mount a glossy, black plastic knob to a beautifully detailed and plated handle. Made with the same quality as the original handles. Plastic backing washers and mounting clips included.

1955-57 Best	#624	\$29.95/pr.
1955-57 Good	#16748	\$19.95/pr.



VENT WINDOW CRANK HANDLES

A molded, glossy black plastic knob is fastened to a beautifully plated handle, complete with plastic backing washers and mounting clips.

1955-57 Best	#623	\$29.95/pr.
1955-57 Good	#16747	\$19.95/pr.



LOKAR BILLET CRESCENT OVAL AND OVAL ARM REST DOOR PULLS

All Polished, Crescent Oval	#17269.....	\$150.95/pr.
All Polished, Oval	#17270.....	\$150.95/pr.



LOKAR ALUMINUM INSIDE DOOR HANDLES

Lokars interior handles feature splined arms for fine adjustment and hidden set screws for that extra attention to detail.

All Brushed.....	#15234.....	\$98.95/pr.
All Polished (Shown).....	#15235.....	\$98.95/pr.
All Black	#15240.....	\$98.95/pr.

LOKAR LAKESTER HANDLES

All Door, Chrome.....	#17271.....	\$98.95/pr.
All Window Cranks, Chrome	#17272.....	\$98.95/pr.
All Vent Window Cranks, Chrome..	#17273.....	\$98.95/pr.
All Door, Midnight Series.....	#18401.....	\$98.95/pr.
All Window Crank, Midnight Series	#18402.....	\$98.95/pr.
All Vent Window Crank, Midnight Series	#18403.....	\$98.95/pr.



LOKAR ALUMINUM WINDOW CRANK HANDLES

All Brushed.....	#15236.....	\$98.95/pr.
All Polished.....	#15237.....	\$98.95/pr.
All Black (Shown).....	#15241.....	\$98.95/pr.



LOKAR ALUMINUM VENT WINDOW CRANK HANDLES

All Brushed (Shown)	#15238.....	\$98.95/pr.
All Polished.....	#15239.....	\$98.95/pr.
All Black	#15242.....	\$98.95/pr.



LOKAR OUTSIDE CUSTOM BILLET DOOR HANDLES

Billet exterior 12-volt door handles are a great way to elevate your vehicle to the next level. Lokar's door handle utilizes a 12-volt pressure pad switch to supply power to the electric actuated door latch. Fabrication required.

All Brushed, Goolsby Edition, 10 Degree, 12-Volt
 #17558..... \$412.95/pr.



CHROME HANDLES WITH BLACK AND CARBON INSERTS

All Door Handles..... #18802..... \$100.95/pr.
All Window Cranks..... #18803..... \$100.95/pr.
All Vent Window Cranks #18804..... \$100.95/pr.



GRAY TRUSS-STYLE HANDLES

All Door Handles..... #18805..... \$127.95/pr.
All Window Cranks..... #18806..... \$132.95/pr.
All Vent Window Cranks #18807..... \$116.95/pr.



HANDLE CLIP REMOVAL TOOL

Removes the horseshoe shaped handle clip, part #215, holding the inside door, window, and vent window handles on all cars utilizing that clip. This tool makes handle removal a snap. Fits many makes and models.

1955-57 #637..... \$8.95/ea.

HANDLE CLIP

Interior door, window and vent window handles are all mounted with this retaining clip. You'll need one clip for each handle mounted. When removing interior handles, the handle clip removal tool, part #637, is essential. This tool is shown above right.



1955-57 #215..... \$0.95/ea.

DOOR AND WINDOW HANDLE SPRING

Use this spring to maintain a firm seal between the inside door handle and the door panel.



1955-57 #625..... \$3.50/ea.

DOOR AND WINDOW HANDLE PLASTIC WASHER

This part fits between the inside door and window handles and the interior door panel.



1955-64 #362..... \$2.25/ea.



PHOTO COURTESY OF GERTMAN2000

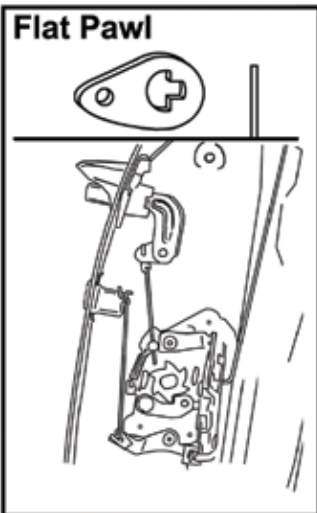

FLAT PAWL APPLICATIONS
 For use on 1956 2 & 4-Door Hardtops and Convertibles and 1957 4-Door Hardtops ONLY.

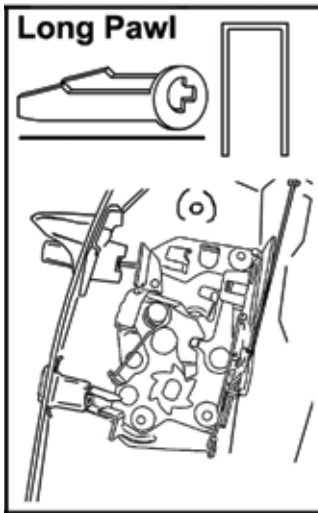

LONG PAWL APPLICATIONS
 All 1955-57 Models except Flat Pawl applications at left.



COMPLETE LOCK SETS

1955-57 Keyed Alike, Long Pawl.. #15517 \$69.95/set
 1955-57 Keyed Alike, Flat Pawl ... #15518..... \$69.95/set



FRONT DOOR HANDLE RELEASE MECHANISMS

This excellent reproduction is made of stamped steel.
 1956-57 4-Door Hardtop, Front #16995.....\$28.95/pr.



DOOR & IGNITION LOCK SETS

Two keys, ignition lock, and two door locks make up each perfectly reproduced set. The faces of the door locks are stainless steel, and the ignition lock turn handles are die-cast and chrome plated. Check your existing lock set carefully before ordering. See pawl chart above.

1955-57 Flat Pawl (Shown)..... #385A..... \$44.95/set
 1955-57 Long Pawl #385B..... \$44.95/set



INTERIOR DOOR RELEASE MECHANISMS

This excellent reproduction is made of stamped steel.
 1955-59 Driver..... #957..... \$21.95/ea.
 1955-59 Passenger #957A..... \$21.95/ea.



DOOR LOCK CATCH MECHANISM SCREW SET

1955-57 #971 \$8.95/set



DOOR LOCK RETAINERS

You can insure that your new door locks will stay in place for good by installing them with new door lock retainers. Our door lock retainers are made of heat treated spring steel for the strongest spring pressure, and are cad plated for rust and corrosion protection. **Made in the USA.**

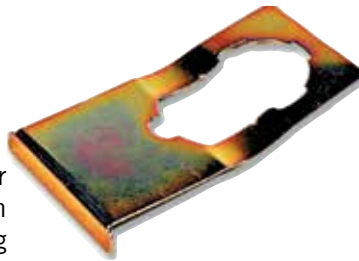

1955-57 2-Door Hardtop, Convertible, 4-Door Sedan & Wagon (Shown) #1905..... \$10.95/ea.
1955-57 2-Door Sedan, Wagon & Sedan Delivery, 4-Door Hardtop & Nomad #2035..... \$9.95/ea.



TRUNK AND GLOVE BOX LOCK SET

A trunk lock, glove box lock, and two keys make up this quality set. The face of the trunk lock is stainless steel. Trunk lock does not fit wagons.

1955-57 #386..... \$29.95/set

RIBBED LOCK CAP

This stainless steel cap, which comes on new locks, accurately finishes off the lock set with the original design contour. Use this to replace caps on original locks.



1955-58 #2107..... \$4.95/ea.

TRUNK LOCK RETAINER



Re-install the trunk lock with a new lock retainer. Each retainer is heated to provide maximum pressure and cad plated to prevent rust and corrosion. **Made in the USA.**

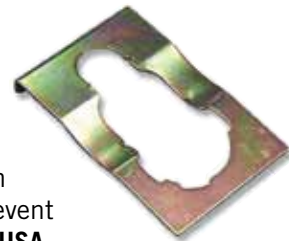

1955-57 #388..... \$11.95/ea.

#17835



LOCK CYLINDER PAWL CLIPS

This clip holds the lock pawl to the lock cylinder.

1955-57 #17835..... \$0.95/ea.
All Half-Moon Shaft..... #19029..... \$0.50/ea.



#19029

TRIDENT STYLE LOCK PAWL RETAINER CLIP

This clip holds the lock pawl to the lock cylinder.

1955-57 #19042..... \$1.95/ea.

TRUNK LOCK SHAFT

This reproduction part is easily installed and will bring back that smooth-operating trunk lock.

1955-57 #387..... \$1.95/ea.

TRUNK LOCK SHAFT RETAINER SPRING

This spring holds the trunk lock shaft into the trunk lock cylinder and often goes missing.

All..... #14946..... \$0.50/ea.



#14160

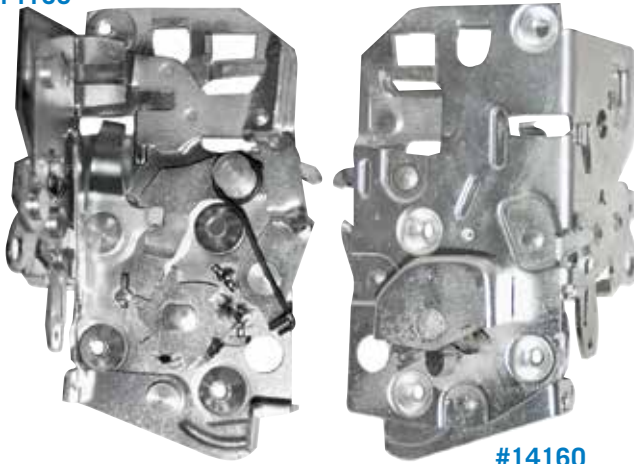

#14160

#16072



#16071

COMPLETE DOOR LATCH ASSEMBLIES

These long pawl style door latches are brand new and ready to replace your troublesome or worn out originals. Chevy used different style latches, the long pawl style was most popular so be sure to check your originals before ordering. Be sure to pick up a set of striker plates, part #1847, to insure you have all the right parts. Door latch assemblies will not work on '56 2-door hardtops and convertibles or 1956-57 4-door hardtops.

1955 Driver.....	#14160.....	\$99.95/ea.
1955 Passenger.....	#14161.....	\$99.95/ea.
1956-57 Driver.....	#14162.....	\$99.95/ea.
1956-57 Passenger.....	#14163.....	\$99.95/ea.



KEY BLANKS

These are Briggs and Stratton replacements. Keys are uncut blanks.

1955-57 Trunk & Glove Box.....	#097.....	\$2.95/ea.
1955-57 Ignition & Door.....	#098.....	\$2.95/ea.



DOOR LATCH TO TUMBLER RODS AND CLIPS

When you have a problem opening your door with your existing key chances are the your rods might be missing. This is the part you need to replace. **Made in the USA.**

1956 2-Door Hardtop & Convertible	#15533.....	\$16.95/set
--	-------------	-------------



REPLACEMENT KEY BLANKS

These are the correct "A" and "B" key blanks for our reproduction lock cylinders. Pearhead shaped blanks are typically used on trunk and glovebox keys and octagon shaped are typically used for doors and ignition. For original lock cylinders see part #097 and #098.

1955-57 "B" Groove, Pear Head...	#17836.....	\$3.95/ea.
1955-57 "A" Groove, Octagon Head	#17837.....	\$3.95/ea.



#14223

#17958

#17955

DOOR LATCH TO HANDLE PULL RODS WITH CLIPS

These run from the door latch handle to the door latch. Proper sleeves and clips included.

1955-57 2-Door Sedan, Nomad & 2-Door Wagon	#14223.....	\$25.95/pr.
1955-57 2-Door Hardtop & Convertible.....	#14308.....	\$25.95/pr.
1956-57 4-Door Hardtop, Front Door.....	#18319.....	\$25.95/pr.
1955-57 4-Door Sedan, Rear Door.....	#17955.....	\$9.95/pr.
1955-57 4-Door Sedan, Front Door	#17958.....	\$24.95/pr.

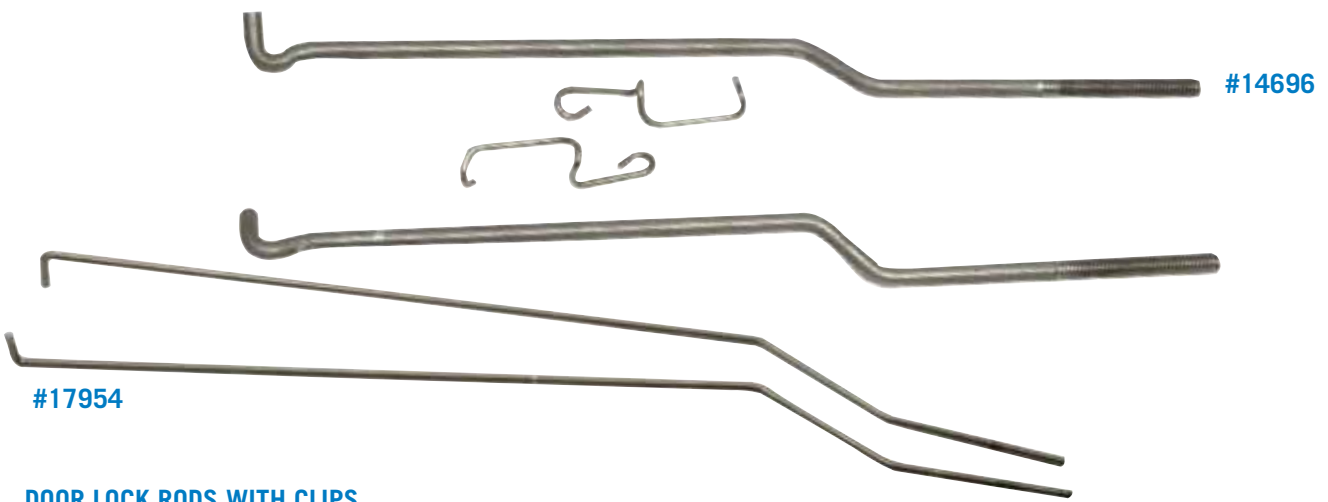

#14696

#17954

DOOR LOCK RODS WITH CLIPS

These are the rods that the door lock knob, #329, screws onto. Clips are sold separately under part #14698.

1955-57 2-Door Hardtop & Convertible.....	#14696.....	\$9.95/pr.
1955-57 Sedan, Nomad & Wagon	#14697.....	\$9.95/pr.
1955-57 Tailgate/Door, Clips Only	#14698.....	\$2.50/pr.
1956-57 4-Door Hardtop, Front Door.....	#17954.....	\$8.95/pr.



REAR DOOR LOCK ROD ASSEMBLIES

These are the rods for the rear doors that the door lock knob, #329 screws onto. Complete assembly.

1955-57 4-Door Sedan, Driver (Shown)	#17956.....	\$27.95/ea.
1955-57 4-Door Sedan, Passenger.....	#17957.....	\$27.95/ea.



BILLET STAINLESS DOOR POST STRIKER PLATES

Original or even the replacement door strikers are not very attractive. Replace yours with these beautiful polished billet pieces and your open doors will look like jewelry. Hardware included.

1955-57 #19389.....\$284.95/pr.

DOOR POST STRIKER PLATES

These install on the "B" pillar and contact the door latch assembly to keep the door closed. One pair does two doors.



1955-59, 56-60 Vette..... #1847.....\$44.95/pr.

DOOR STRIKER SHIMS

These help line up the striker plate to the latch assembly, used as needed.



1955-57 Driver..... #12325.....\$7.95/ea.

1955-57 Passenger..... #12326.....\$7.95/ea.



DOOR POST STRIKER LOCK PLATES

These mount under the striker plates and help keep them in place. One set will do two striker plates. One installs at the top, one at the bottom.

1955-57 #12324..... \$13.95/set

DOOR POST STRIKER SCREWS

One set per car. **Made in the USA.**



1955-57 2-Door & 56-62 Vette #10253..... \$10.95/set

1955-57 4-Door #10253A..... \$14.95/set

SMOOTH DOOR LOCK KNOBS

These polished CNC machined billet aluminum door lock knobs are the perfect finishing touch for your classic. 6-40 thread and 1-5/8-inch tall.



All..... #18598.....\$25.95/pr.



ORIGINAL STYLE DOOR LOCK KNOBS



Made to look like the originals but produced from billet aluminum. These door lock knobs are made in the good old USA by Danchuk. Available in either regular billet or a beautiful chrome plating. **Made in the USA.**

1955-57 Billet..... #14656\$22.95/pr.

1955-57 Chrome #14656A\$32.95/pr.



DOOR LOCK KNOBS



5-6-7 owners don't have to settle for cheap auto parts store replacement door lock knobs! We've made these repros available in the original colors. **Made in the USA.**

1955-57 Black #329.....\$8.95/pr.

1955-57 Red..... #329A.....\$8.95/pr.

1955-57 Yellow..... #329B.....\$8.95/pr.

1955-57 Dark Blue #329C.....\$8.95/pr.

1955-57 Turquoise #329D.....\$8.95/pr.

1955-57 Green..... #329E.....\$8.95/pr.

1955-57 Sierra Gold..... #329F\$8.95/pr.

1955-57 Light Blue..... #329G.....\$8.95/pr.



UPPER DOOR HINGES WITH WIRE CHANNELS

Woody's Hot Rodz 1955-57 custom upper door hinges are designed to allow easy and clean routing of wires to your door, especially useful with power windows. Simply route wires through the milled groove in the top of the hinge and then screw on the cap with included screws. The stock-style hinge fits all 1955-57 Chevrolet sedan, hardtop, convertible and wagon models. Hinges are sold as a pair, one for each front door.

1955-57 #18128..... \$329.95/pr.



DOOR JAMB REINFORCEMENTS

Fits 2-Door hardtops and convertibles. With minor modifications can be used on 2-Door sedans.

1955-57 Driver #10199..... \$151.95/ea.

1955-57 Passenger #10200..... \$151.95/ea.



FRONT DOOR HINGE TO DOOR BOLTS

Enough for all four hinges.

1955-57 #2062..... \$11.95/set



FRONT DOOR HINGE BACKING PLATES

Door hinge backing plate is the threaded plate that the door hinge gets mounted to and is installed behind the door hinge inside of the A-pillar. 1955-56 require two, while the 1957 requires four.

1955-56 Upper..... #16834..... \$13.95/ea.

1955-56 Lower..... #16835..... \$11.95/ea.

1957..... #16836..... \$11.95/ea.



REAR DOOR HINGE SCREWS

Enough for one hinge.

1955-57 4-Door #1483..... \$11.95/set



FRONT DOOR HINGE TO PILLAR SCREWS

One set does all four hinges.

1955-57 #970..... \$5.95/set



POLISHED ALUMINUM DOOR LOCK KNOBS

1940-57 w/ Plain Head..... #10057A..... \$30.95/pr.



DOOR HINGE PIN

These install in the door hinge along with the door hinge bushings #4821. Replacement of these pins along with new bushings will take up the play in your door hinges. One per hinge required.

1955-57 #1565..... \$1.95/ea.



DOOR HINGE BUSHING

These are used with the door hinge pins #1565 to take up the play in your door hinge. Two per hinge required.

1938-72 #4821..... \$2.95/ea.

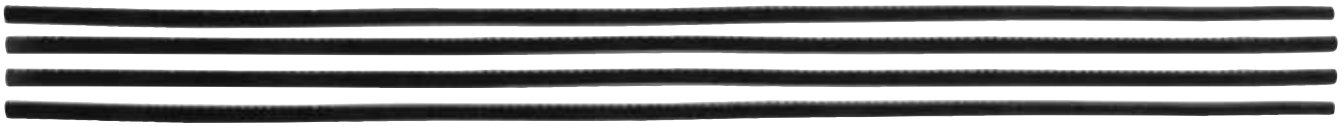

FLIPPER RELINING KIT

Installs with adhesive, one set does both flippers.

1955-57 2-Door Hardtop..... #12406..... \$54.95/kit

DOOR FLIPPERS



PLASTIC FLIPPER LEVER COVERS

Prevents scratching of the vent window frame assembly.

1955-57 2-Door Hardtop..... #10161..... \$6.95/pr.



FLIPPER SPRINGS

One of the cleverest solutions for the hardtop is the flipper unit. Don't let your flipper springs go neglected. Weak springs defeat the purpose of the flipper, never allowing it to close completely. These are must replace items.

1955 2-Door Hardtop..... #149A..... \$11.95/set

1956-57 2-Door Hardtop..... #149..... \$9.95/set

DOOR FLIPPER STOPS AT REAR

This is the rear flipper seal, which mounts inside the flipper opening. Mounted by rearmost flipper screw. Tab faces forward while the opening faces out.



1955-57 2-Door Hardtop..... #832..... \$14.95/pr.



FLIPPER AND REAR WINDOW FUR CHANNEL SCREW SET

1955-57 2-Door Hardtop..... #2071..... \$9.95/set



FLIPPER RIVETS

1955-57 2-Door Hardtop..... #12719..... \$4.95/set



PHOTO COURTESY OF GERTMAN2000

FLIPPER SEALS



Without the flipper seal the flipper is noisy and practically useless. Keep the drafts and noise out, and allow the flipper to do the job it was designed for. Rolled edge overhangs top of flipper to the outside.



Made in the USA.

1955-57 2-Door Hardtop..... #840.....\$19.95/pr.

DOOR FLIPPER STOPS AT FRONT

Mounts inside flipper opening and is held in by glue and by forward-most flipper screw. Open side faces in, while front lower flap sits against windshield pillar.



1955-57 2-Door Hardtop..... #831.....\$17.95/pr.



DOOR AND SIDE WINDOW ACCESS HOLE COVERS

1955-57 Hardtop..... #2979..... \$85.95/set
 1955-57 Sedans..... #15039..... \$91.95/set
 1955-57 Convertible..... #2978..... \$85.95/set



SEDAN DOOR UPPER ACCESS PLUGS

1955-57 #833.....\$5.95/pr.



REAR DOOR RUBBER PLUG

This plug covers the access hole for the door handle screw. Two needed per car.



1956-57 4-Door Hardtop..... #828.....\$3.95/ea.

COWL SIDE DRAIN GUTTERS

Don't let the interior of your car be damaged for the lack of a simple part. The cowl side drain gutter prevents water from leaking through the door, keeping your carpet and door panel cardboard dry.

1955-57 #2073.....\$19.95/pr.



INNER DOOR ACCESS PANEL SCREWS

1955-57 #2896..... \$14.95/set

4-DOOR RUBBER BUMPERS



Doors need these bumpers to close securely and keep from rattling. Part #806 also serves as the liftgate on body rubber bumper for 5-6-7 station wagons.



Made in the USA.

1955-57 Sedan #805.....\$3.95/ea.

1956-57 Hardtop..... #806.....\$4.95/ea.

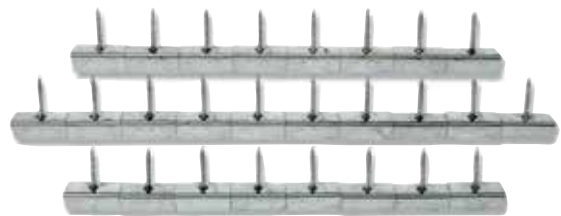

DOOR PANEL CLIP AND NAIL SET

26-Piece. 4-door models require two sets.

1955-57 #078..... \$21.95/set



DOOR BELT MOULDING SCREWS

1955-57 (exc. Sedan & Wagon)... #1028..... \$2.95/set



DOOR PANEL TRIM

STAINLESS STEEL INTERIOR DOOR PANEL TRIM KITS O/S

These kits are a must for those re-upholstering their interiors or just bringing back that original look. All of the kits below are complete, including both front doors and rear quarter trim, or rear door trim, as applicable.

1955 Nomad	#11318.....	\$681.95/set	1956 210 2-Door Sedan	#11323.....	\$208.95/set
1955 Convertible.....	#1437.....	\$404.95/set	1956 Bel Air 4-Door Sedan	#11324.....	\$323.95/set
1955 Del Ray 2-Door Sedan	#2043.....	\$174.95/set	1956 Bel Air 2-Door Sedan	#1438.....	\$324.95/set
1955 210 2-Door Sedan	#2042.....	\$174.95/set	1956 Bel Air 2-Door Hardtop	#2037.....	\$324.95/set
1955 Bel Air 2-Door Hardtop	#1436.....	\$404.95/set	1956 Bel Air 4-Door Hardtop	#2039.....	\$324.95/set
1955 Bel Air 2-Door Sedan	#1911.....	\$365.95/set	1957 Nomad	#2041.....	\$404.95/set
1955 Bel Air 4-Door Sedan	#11319.....	\$404.95/set	1957 Convertible.....	#1397.....	\$404.95/set
1955 Nomad Lower Door Waffle Trim	#17761.....	\$107.95/ea.	1957 210 2 Door Sedan.....	#2044.....	\$324.95/set
1956 Nomad	#2040.....	\$345.95/set	1957 210 4-Door Sedan	#2045.....	\$324.95/set
1956 Bel Air Convertible.....	#2038.....	\$324.95/set	1957 Bel Air 2 Door Hardtop	#1396.....	\$404.95/set
1956 Del Ray 2-Door Sedan	#11320.....	\$182.95/set	1957 Bel Air 2-Door Sedan	#1439.....	\$244.95/set
1956 210 2-Door Hardtop	#11321.....	\$208.95/set	1957 Bel Air 4-Door Hardtop	#1440.....	\$404.95/set
1956 210 4-Door Hardtop	#11322.....	\$208.95/set	1957 Del Ray 2-Door Sedan	#11325.....	\$208.95/set
			1957 Bel Air 4 -Door Sedan	#11326.....	\$244.95/set

DOOR PANEL ATTACHING STRIP

Welds to inner door sheet metal and holds the bottom edge of the door panel.

1955-57



INTERIOR DOOR GARNISH CLIPS

These install under the door interior garnish moulding. One goes at the front of the door and the interior garnish gets screwed into it. The second mounts midway on the top inner area of the door to support the moulding in the center. Two pairs required per car.

1955-57 2-Door Hardtop & Conv. . #974.....\$9.95/pr.



DOOR WEATHERSTRIP RETAINERS AND SCREWS

This is a must for every door weatherstrip replacement job. These retainers and screws also fit wagon and Nomad tailgates. Use as needed. **Made in the USA.**

1955-57



INTERIOR DOOR PANEL TRIM JOINER CLIPS

1955 2 & 4-Door Bel Air

1957 2 & 4-Door 210

1957 2 & 4-Door Hardtop, Convertible & Nomad

.....

DOOR WINDOW UPPER MOULDING CLIPS

Mounts the moulding above the door glass. End clips not included. One set does two doors.

1955-57 Bel Air Sedan, 2 & 4-Door



DAKOTA DIGITAL COMMANDER KEYLESS ENTRY BASE SYSTEMS

The Commander 10K offers modern conveniences of keyless entry, trunk release and can be expanded up to 10 functions such as remotely opening and closing power windows, doors, trunk etc.

- All 10-Channel #15116..... \$199.95/ea.
- All 10-Channel, with 2 PDR-1 Actuators (Shown)..... #15117..... \$279.95/ea.
- All 10-Channel, with 3 PDR-1 Actuators #15118..... \$299.95/ea.



DAKOTA DIGITAL DOOR ACTUATORS

Extra door actuators will be required when expanding the Commander 10K System. The 10-pound version is typically used in door applications. The 35-pound version is for applications that require more force.

- All 10-Lb. Force..... #15121 \$39.95/ea.
- All 35-Lb. Force, w/ Relay & Hardware
..... #15122..... \$81.95/ea.



POWER KEYLESS REMOTE DOOR LOCK CONVERSION KIT

This kit adds the convenience and safety of modern keyless entry to your classic. The keyless entry module comes with onboard relays for a clean installation, two-two button remote controls, two door lock actuators with 15 lbs. of pull and built in overload protection, two actuator mounting brackets, two rubber door jamb boots, two actuator connecting rods and clips, wire harness, full color step by step instruction manual, and all necessary hardware.

- 1955-57 #18720\$259.95/kit



DAKOTA DIGITAL RELAY KITS

Extra relays may be needed when expanding the functions of the Commander 10K system or can be used with fan controllers in dual fan applications.

- All 30 Amp, Single..... #15119..... \$11.95/kit
- All 30 Amp, Dual..... #15120..... \$29.95/kit



2-DOOR FRONT WINDOW REGULATOR ASSEMBLIES

- 1955-57 Hardtop, Convertible, Driver #11214..... \$94.95/ea.
- 1955-57 Hardtop, Convertible, Passenger #11215..... \$94.95/ea.
- 1955-57 Sedan, Nomad & Wagon, Driver #11216..... \$94.95/ea.
- 1955-57 Sedan, Nomad & Wagon, Passenger #11217..... \$94.95/ea.



4-DOOR HARDTOP FRONT WINDOW REGULATOR ASSEMBLIES

- 1956-57 Driver..... #17307..... \$116.95/ea.
- 1956-57 Passenger..... #17308..... \$116.95/ea.

2-DOOR REAR WINDOW REGULATOR ASSEMBLIES

- 1955-57 Hardtop, Driver #12402..... \$94.95/ea.
- 1955-57 Hardtop, Passenger #12403..... \$94.95/ea.
- 1955-57 Sedan, Driver #12404..... \$94.95/ea.
- 1955-57 Sedan, Passenger..... #12405..... \$94.95/ea.
- 1955-57 Convertible, Driver..... #16200..... \$99.95/ea.
- 1955-57 Convertible, Passenger .. #16201..... \$99.95/ea.

WINDOW REGULATOR GEAR PLATES

If the teeth are worn or chipped on your gear plate you'll notice the strain and slipping when rolling up the window. This part is easily replaced when overhauling the window assembly.



- 1955-57 2-Door Hardtop & Conv., Front Only, 20 Teeth #953..... \$24.95/ea.
- 1955-57 2 & 4-Door Sedan, Nomad & Wagon, Front Only 23 Teeth..... #954..... \$24.95/ea.

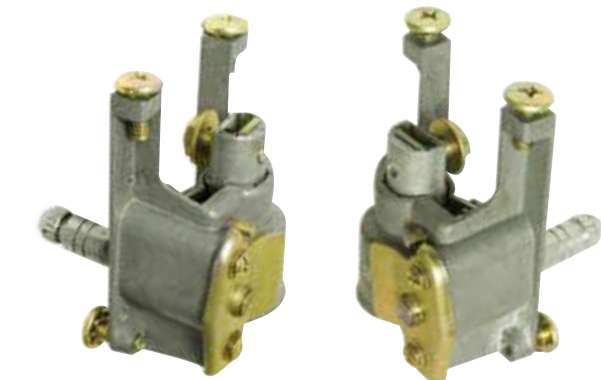

VENT WINDOW REGULATORS

- Mounting screws included.
- 1955-57 Driver..... #14864..... \$77.95/ea.
 - 1955-57 Passenger..... #14865..... \$77.95/ea.

WINDOW REGULATOR GROMMETS

- This foam grommet surrounds the door and window handle spring and provides a cushion between the door panel and the door. Four per set. **Made in the USA.**
- 1955-57 #827..... \$8.95/set





POWER WINDOW CONVERSION KITS

1955-57 2-Windows, Nomad, Hardtop & Convertible.....	#14846.....	\$438.95/kit
1955-57 2-Windows, Sedan Delivery.....	#14847.....	\$438.95/kit
1955-57 2-Windows, 2-Door Wagon.....	#14848.....	\$438.95/kit
1955-57 2-Windows, 2-Door Sedan.....	#14849.....	\$438.95/kit
1955-57 4-Windows, 2-Door Hardtop	#14850.....	\$834.95/kit
1955-57 4-Windows, 2-Door Sedan & Wagon (Shown).....	#14851.....	\$834.95/kit
1955-57 4-Windows, 2-Door Convertible	#14852.....	\$863.95/kit
1955-57 4-Windows, Universal, 4-Door Sedan & Wagon	#14853.....	\$834.95/kit
1955-57 2-Windows, 2-Door Sedan w/ Vent Removed	#14854.....	\$446.95/kit
1955-57 4-Windows, 2-Door Sedan w/ Vent Removed	#14855.....	\$854.95/kit



VENT WINDOW POWER CONVERSION KIT

This kit is the perfect addition to your power window conversion.

1955-57	#14214.....	\$498.95/kit
---------------	-------------	--------------



POWER WINDOW

POWER WINDOW BUTTON SWITCHES, ORIGINAL STYLE

When purchasing these switches, pigtails shown below, are necessary. Switches include retainers. These are not a direct replacement for original switches.

- 1955-57 4-Button..... #11356..... \$84.95/ea.
- 1955-57 Single Button..... #11357..... \$59.95/ea.
- 1955-57 2-Button..... #11358..... \$99.95/ea.

WINDOW REGULATOR ROLLERS AND RIVETS



If these parts are missing or cracked, window operations cease to exist. Three required per window; 12 per car. **Made in the USA.**



- 1955-57 1/4" Rivet..... #1001..... \$2.95/ea.
- 1955-57 5/16" Rivet..... #11287..... \$4.95/ea.



WINDOW REGULATOR SCREWS

One set mounts two regulators.

- 1955-57 8-Piece..... #15434..... \$4.95/set

UPPER DOOR HINGES WITH WIRE CHANNELS

Woody's Hot Rodz 5-6-7 custom upper door hinges are designed to allow easy and clean routing of wires to your door, especially useful with power windows. Simply route wires through the milled groove in the top of the hinge and then screw on the cap with included screws. Provides a clean look when the door is open and hides the ugly wires that would usually show. The stock-style hinge fits all 5-6-7 Chevrolet sedan, hardtop, convertible and wagon models. Hinges are sold as a pair, one for each front door.



- 1955-57 #18128..... \$329.95/pr.



POWER WINDOW SWITCH RETAINERS AND LOCKS

Not for use with original power window switches.

- 1955-57 4-Button..... #11359..... \$9.35/ea.
- 1955-57 2-Button..... #11359A..... \$9.95/ea.
- 1955-57 Single Button..... #11360..... \$5.95/ea.



STAINLESS FLEXIBLE WIRE CONDUITS

These conduits are a clean solution for running wires between the doors and A-pillar for power window or keyless entry systems.

- All 5/8" w/ Bushings..... #15156 \$36.95/ea.
- All 3/4" w/ Bushings..... #15157..... \$36.95/ea.

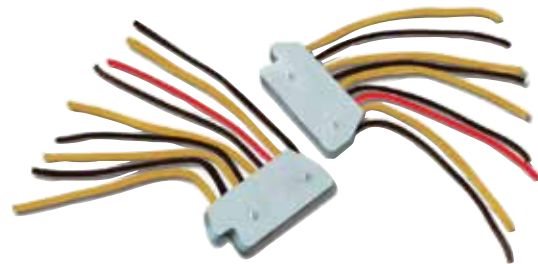

POWER WINDOW SWITCH PIGTAILS

For use with power window switches, parts #11356-11358, only.

- 1955-57 4-Button..... #11356A..... \$43.95/ea.
- 1955-57 Single Button..... #11357A..... \$16.95/ea.
- 1955-57 2-Button..... #11358A..... \$32.95/ea.



POWER WINDOW WIRE CONDUIT

- 1955-57 #11355..... \$48.95/set



SIDE WINDOW UPPER AND LOWER MOULDING CLIPS

Includes all clips and screws to attach the beltline and window area stainless trim.

- 1955-57 Bel Air 2-Door Sedan #2263..... \$84.95/set
- 1955-57 Bel Air 4-Door Sedan (Shown) #2264..... \$106.95/set



WINDOW MOULDING CONNECTORS

- Made in the USA* 
- 1955-57 exc. 1955 150, Best, Lower Windshield #2056* \$13.95/ea.
 - 1955-57 exc. 1955 150 Good, Lower Windshield #16807..... \$6.95/ea.
 - 1955-57 exc. 1955 150 & Conv., exc. 56-57 Conv., Upper Windshield #2057* \$13.95/ea.
 - 1955-57 Sedan, 2-Door Hardtop, Best Lower Rear #2058* \$13.95/ea.
 - 1955-57 Sedan, 2-Door Hardtop, Good, Lower Rear #16808..... \$6.95/ea.
 - 1956-57 4-Door Hardtop, Lower Rear #2059* \$13.95/ea.



REAR WINDOW MOULDING CLIPS

- These clips mount the rear window moulding, sometimes called the "reveal moulding."
- 1955-57 #247..... \$8.95/set

REAR QUARTER UPPER WINDOW MOULDING CLIPS

Attaches ONLY the moulding above the quarter glass. One set does both sides. Included in part #2263.

- 1955-57 Bel Air 2-Door Sedan #1076..... \$21.95/set

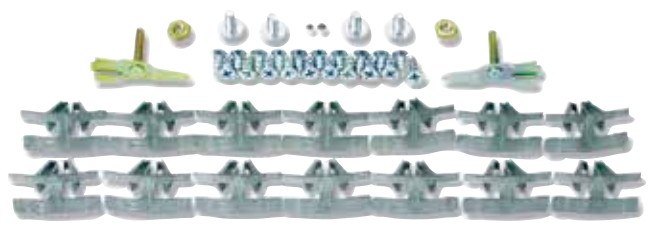

REAR QUARTER WINDOW MOULDING CLIPS

Attaches the moulding above and below the rear quarter side glass. Upper and lower. One set does both sides. Included in part # 2263.

- 1955-57 Bel Air 2-Door Sedan #1077..... \$23.95/set

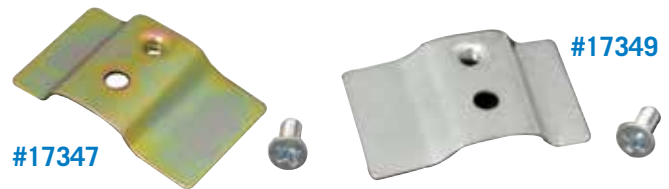

SEDAN UPPER DOOR GLASS MOULDING END CLIPS

For use with Danchuk #940 door upper moulding clips on page 620.

- 1955-57 Driver Front #17347..... \$4.95/ea.
- 1955-57 Driver Rear #17348..... \$4.95/ea.
- 1955-57 Psngr. Front..... #17349..... \$4.95/ea.
- 1955-57 Psngr. Rear #17350..... \$4.95/ea.



SEDAN LOWER DOOR GLASS MOULDING END CLIPS

- 1955-57 Driver Front, Pass. Rear . #17351..... \$5.25/ea.
- 1955-57 Driver Rear, Pass. Front.. #17352..... \$5.25/ea.

DOOR WINDOW MOULDING SCREWS

- One set does 2 doors.
- 1955-57 2 & 4-Door Sedan, Lower #19281..... \$3.95/set

 **WARNING!** Products on these pages may contain chemicals known to the State Of California to cause cancer and/or birth defects or reproductive harm. www.p65warnings.ca.gov



WINDOW FUR CHANNEL KITS

Daily window use has usually worn those old fur channels to the point where the windows are loose, and may even rattle. Each kit of our “fuzzies” contains all of the parts you need to completely replace your window channels. We’ve reproduced these kits with all the correct contours and lengths. The exposed beaded edges of the channels are made of polished stainless steel, just like the factory originals. The hardtop kit does not include the upper portion of the roof line contour, available under part #2070, shown at right. **Made in the USA***.

- 1955-57 2-Door Hardtop..... #172*\$129.95/kit
- 1955-57 2-Door Sedan #174* O/S\$239.95/kit
- 1955-57 2-Door Wagon #178* O/S\$239.95/kit
- 1956-57 4-Door Hardtop..... #173*\$129.95/kit
- 1955-57 4-Door Sedan #175* O/S\$239.95/kit
- 1955-57 4-Door Wagon (Shown) .. #179* O/S\$239.95/kit
- 1955-57 Convertible..... #176*\$129.95/kit
- 1955-57 Nomad #177* O/S\$179.95/kit
- 1955-57 Sedan Delivery, Utility Sedan
..... #174A O/S\$139.95/kit
- 1955-57 2-Door Sedan w/ No Vent Windows
..... #174B O/S\$239.95/kit
- 1955-57 2-Door Sedan, Utility Sedan w/ No Vent
Windows #174C O/S\$169.95/kit



FUR CHANNEL TRACKS

This track holds the fur channel in place at the front of the rear quarter window on your 2-door sedan and wagon.

- 1955-57 Vertical Post, 2-Door Sedan & Wagon
..... #15767\$21.95/pr.



WINDOW RUNNERS O/S

These pre-bent window runner fur channels come with the original style “Rosebud” Retaining clips pre-attached ready to install. Front Door runners also work on 2-door wagons.
1955-57, Quarter, 2-Door Sedan... #18105.....\$209.95/pr.
1955-57 Door, 2-Door Sedan..... #18106.....\$209.95/pr.
**1955-57 Front Door, 4-Door Sedan
 #18679.....\$169.95/pr.**

REAR WINDOW CORNER MOULDINGS



This Danchuk reproduction is made of stainless steel, with the threaded clip welded in place. This is an exact duplication of the original.

- 1955-57 2-Door Hardtop..... #161\$21.95/pr.
- 1955-57 Sedan (Shown)..... #162.....\$21.95/pr.

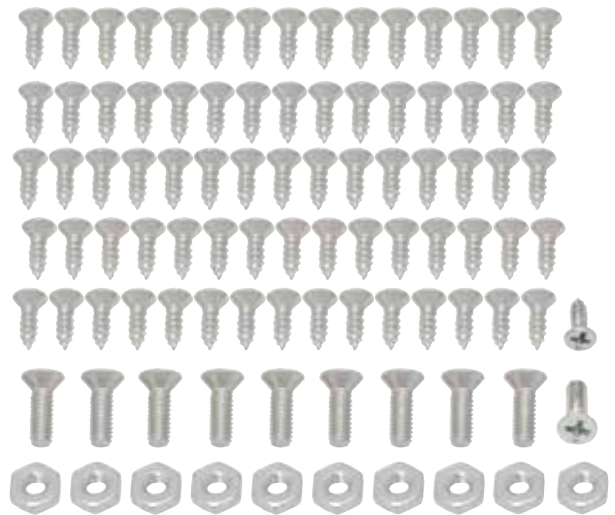

FUR CHANNEL SCREW KIT

- 1955-57 #13349.....\$7.95/kit



WINDOW RELINING KIT

This kit fits the upper portion of the rear. Mounting glue is included.

1955-57 2-Door Hardtop..... #2070..... \$47.95/kit



WINDOW PILLAR SPACER CAPS

These molded rubber pillar caps are often missing or need replacement. They mount on the center interior pillar cover on 2-door wagons. One 4-piece set required.

1955-57 #15534 \$31.95/set



WINDOW ADJUSTING PLATES AND HARDWARE

Located in the door jamb just outside the weatherstrip, this allows you to adjust the vertical glass run channel inside the door. Includes #846 adjusting seal. One set does two doors.

1955-57 2-Door Hardtop, Nomad & Conv.
..... #1164..... \$12.95/set



U-CHANNEL GUIDE

Track for the fur channel located to the rear of the front door on two-door models and on the front doors on 4-door models. Can be modified to work on rear quarter glass on 2 and 4-door front doors.

1955-57 Sedan & Wagon..... #12698..... \$12.95/ea.



WINDOW CHANNEL ADJUSTING SEALS

Replacement seals for the window adjustment plates. One set does two doors. **Made in the USA.**

1955-57 2 & 4-Door Hardtop, Conv., & Nomad
..... #846..... \$4.95/pr.

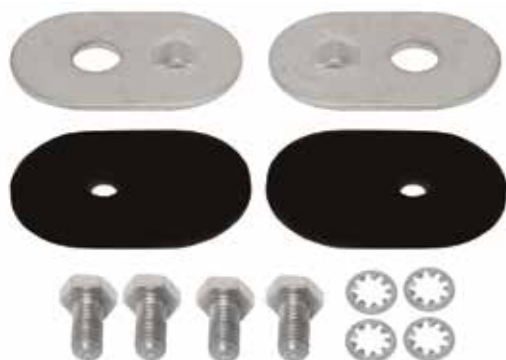

FRONT DOOR WINDOW ADJUSTING PLATE SET

Located outside the door weatherstrip on the front doors. Includes hardware and seal. One set does two doors.

1956-57 Hardtop, 4-Door..... #18930..... \$16.95/set



PHOTO COURTESY OF GERTMAN2000



WINDSHIELD VISORS O/S

These reproduction sheetmetal visors capture the trend of the times and add a retro touch to your classic Chevy.

1955-57 Sedan & Wagon.....	#18446.....	\$599.95/ea.
1955-57 Hardtop & Nomad	#18447.....	\$649.95/ea.

WINDOW RELATED



REAR WINDOW MOULDINGS

O/S

1955-57 Upper, Sedan.....	#17949.....	\$139.95/ea.
1955-57 Lower, Sedan.....	#17950.....	\$229.95/ea.
1955-57 3-Piece, Sedan.....	#17951.....	\$329.95/set

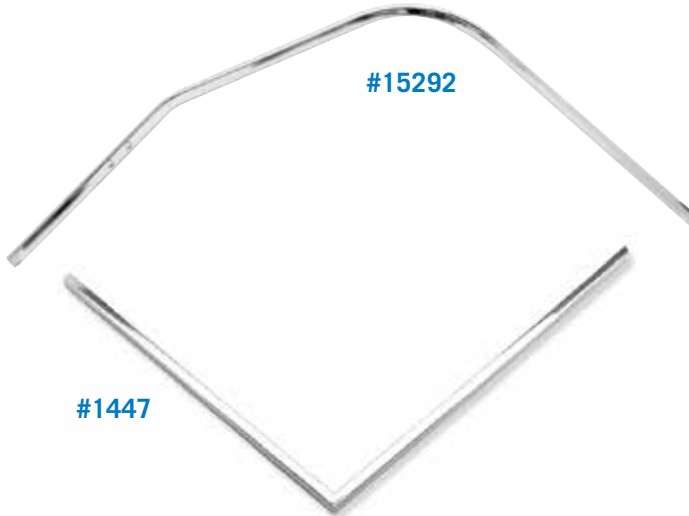

CHROME DOOR WINDOW FRAMES O/S

Get rid of the years of wear and weather with these beautiful reproduction window frames.

1955-57 2-Door Hardtop & Convertible, Either Side	#1447.....	\$73.95/ea.
1955-57 Nomad & Safari, Upper, Either Side	#15292.....	\$79.95/ea.



LOWER WINDSHIELD TO DASH GARNISH TRIM



1955-57 Painted	#16146.....	\$129.95/ea.
-----------------------	-------------	--------------



NOMAD STATIONARY GLASS MOULDINGS

These are the moldings that install on the front edge of the curved quarter glass and include the felt pre-installed.

1955-57 w/ Felt.....	#15541	\$144.95/pr.
----------------------	--------------	--------------



NOMAD SLIDER GLASS STAINLESS EDGE MOULDINGS

1955-57	#18326.....	\$124.95/pr.
---------------	-------------	--------------



UPPER WINDSHIELD MOULDINGS O/S

1955-57 Hardtop & Nomad, Driver & Passenger.....	#17952.....	\$154.95/pr.
1955-57 Sedan & Wagon, Driver.....	#19148.....	\$75.95/ea.
1955-57 Sedan & Wagon, Passenger	#19149.....	\$75.95/ea.

LOWER WINDSHIELD MOULDINGS O/S

1955-56 Driver, Except 150	#18182.....	\$65.95/ea.
1955-56 Passenger, Except 150	#18183.....	\$65.95/ea.
1957 Driver.....	#18184.....	\$65.95/ea.
1957 Passenger	#18185.....	\$65.95/ea.

CORNER WINDSHIELD MOULDINGS

1955-57 Driver.....	#15618.....	\$59.95/ea.
1955-57 Passenger	#15619.....	\$59.95/ea.

1957 LOWER WINDSHIELD GASKET CHANNELS O/S

1957 2-Piece.....	#17907.....	\$61.95/pr.
-------------------	-------------	-------------



HARDTOP REAR WINDOW MOULDINGS O/S

1955-57 2-Door Hardtop, Upper	#14987.....	\$148.95/ea.
1955-57 2-Door Hardtop, Lower, Left & Right.....	#14987A.....	\$231.95/pr.
1955-57 2-Door Hardtop, 3-Piece Set (Shown)	#14987B.....	\$331.95/set



CONVERTIBLE INSIDE TOP WINDSHIELD MOULDINGS

1955-57 #19422 \$144.95/pr.

#2056



#2059

#2057

#2058

WINDSHIELD/REAR WINDOW MOULDING CONNECTORS



Our moulding connectors include all the original contours, ensuring a correct and easy installation. Replace your pitted and scratched originals with these quality stainless steel connectors. Corner mouldings available on page 626. **Made in the USA*.**

- 1955-57 exc. 1955 150, Best, Lower Windshield #2056* \$13.95/ea.
- 1955-57 exc. 1955 150 Good, Lower Windshield #16807 \$6.95/ea.
- 1955-57 exc. 1955 150 & Conv., exc. 56-57 Conv., Upper Windshield #2057* \$13.95/ea.
- 1955-57 Sedan, 2-Door Hardtop, Best Lower Rear #2058* \$13.95/ea.
- 1955-57 Sedan, 2-Door Hardtop, Good, Lower Rear #16808 \$6.95/ea.
- 1956-57 4-Door Hardtop, Lower Rear #2059* \$13.95/ea.

WINDSHIELD GUTTER INNER COWL PANEL DRAIN SEALS

Whenever replacing glass, the drain seal should be inspected, and replaced if necessary. After 60 years this drain seal is often cracked, clogged, or both.



- 1955 (Shown) #802 \$15.95/pr.
- 1956-57 #803 \$15.95/pr.

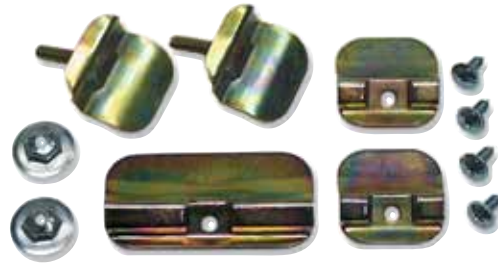

WINDSHIELD MOULDING CLIPS

This set mounts the lower windshield moulding. Use with part # 015A, shown below, to complete your installation. 1955-57 #015 \$12.95/set



WINDSHIELD CORNER MOULDING CLIPS

This set mounts the windshield moulding corner escutcheon. 1955-57 #015A \$9.95/set



INTERIOR LOWER WINDSHIELD CENTER CONNECTOR MOULDINGS



Installs on the front lower center windshield garnish moulding. **Made in the USA.**

- 1955-57 #10319 \$8.95/ea.
- 1955-57 Chrome #10319A \$16.95/ea.



WINDSHIELD SEALS

Body shops, glass shops, painters, and restorers all agree that there is no substitute for our windshield seals. The fit is an absolute match to the original part, and our high quality rubber formulas make these longer lasting than the original Chevrolet versions. Part #568 has no provision for trim. **Made in the USA.**

- 1955-57 All exc. 1955 150 #567..... \$52.95/ea.
- 1955 150 (No Chrome) #568..... \$49.95/ea.



WINDSHIELD PILLAR SEALS

Top quality rubber, new precision molds, and careful research are combined to produce the best sealing, best fitting windshield pillar seal available. Includes plastic installation clips. We recommend 3M weatherstrip adhesive for installation. **Made in the USA.**

- 1955-57 Hardtop, Convertible & Nomad #245..... \$9.95/pr.



INTERIOR PILLAR WEATHERSTRIP CHANNEL MOULDINGS

These install on the back side of the windshield pillar. The vent window frame closes against these parts.

- 1955-57 Convertible... #16141. \$77.95/pr.

PLATED WINDSHIELD PILLAR SCREW SET

The cad plate finish ensures these screws will hold moulding in place, yet be camouflaged from view.

- 1955-57 #070..... \$3.25/set



WINDSHIELD WIPER ESCUTCHEONS

These install around the wiper transmissions where they protrude through the cowl. The nuts hold the transmissions in place against the back of the cowl. Part #208 is used on 1955 150 which has no windshield chrome.

Made in the USA.

- 1955 150..... #208..... \$49.95/set
- 1955-56 (exc. 55-150)..... #210A..... \$49.95/set
- 1957 (Shown) #210..... \$49.95/set



WIPER SAVERS

Wiper savers install on the wiper transmissions when you do not mount wiper blades. Available in two styles, original snub nosed and bullet, both show chrome plated and ready to install. **Made in the USA.**

- All..... #1922..... \$19.95/pr.
- All Bullet Style..... #12621..... \$27.95/pr.

WIPER ESCUTCHEON NUT TOOL

We've upgraded this tool to include the T-handle, making our new version even more convenient to use. Don't worry about losing the handle; it's pressure fit into the tool. With this handy implement escutcheon nuts are easily removed, and scratched hardware is a thing of the past.

- 1953-58 #912..... \$14.95/ea.



WINDSHIELD WIPER WASHER CONTROL CABLE AND HEADLIGHT SWITCH NUT TOOL

- 1955-57 Wiper Switch..... #913..... \$16.95/ea.
- 1957 Headlight Switch #913..... \$16.95/ea.



SHOW QUALITY WIPER ARMS

If the best quality and most correct configuration is what you're after, then these are the wiper arms for you.

1955-56 Vacuum/Electric (exc. '56 Delco), Hook.....	#10137.....	\$56.95/pr.
1957 Vacuum, Hook	#10138.....	\$62.95/pr.
1957 Electric, Straight End	#10139.....	\$56.95/pr.
1955-57 Wiper Blades for Hook End Arms	#17416.....	\$16.95/ea.



POLISHED STAINLESS STEEL WIPER ARMS

Bring the highly polished look back to your windshield wipers with these stainless steel wiper arms. For use with our wiper blades 2518L and 2518R below.

1954-59 Driver.....	#2519.....	\$23.95/ea.
1954-59 Passenger	#2520.....	\$23.95/ea.



POLISHED STAINLESS STEEL WIPER BLADES

This is the blade that belongs on our highly-polished wiper arms, the combination you need to restore your car back to its original look. For use with our #2519 and #2520 wiper arms.

1954-59 Driver.....	#2518L.....	\$23.95/ea.
1954-59 Passenger	#2518R.....	\$23.95/ea.



WINDSHIELD WIPER PIVOT RIVETS

With the introduction of our stainless steel windshield wiper arm pivot rivet, it is now possible to disassemble, rechrome and reassemble the wiper arm assembly for that factory fresh look.

1955-57, '53-62 Vette	#1553	\$2.95/pr.
-----------------------------	-------------	------------



WINDSHIELD WIPER MOTOR SLIDES

Since these under-the-hood connections are plastic, they are prone to heat deterioration and discoloration. Don't let them break unexpectedly. This is a low-cost item that should be replaced regularly. Part #211B is a plastic adapter to be used with #211A for vehicles with factory washer bottles.

1957 & 56-62 Vette	#211	\$9.95/ea.
1955-56 Best	#211A.....	\$8.95/ea.
1955-56 Good.....	#16768.....	\$5.95/ea.
1955-56 Adapter	#211B.....	\$7.95/ea.



REPLACEMENT ELECTRIC WIPER MOTORS

Bolts to factory wiper motor location and works with original wiper transmissions.

1955-56 2-Speed Switch	#11224.....	\$246.95/ea.
1955-56 Intermittent Switch	#11224A...	\$349.95/ea.
1957 2-Speed Switch w/ Extension	#11225.....	\$274.95/ea.
1957 Intermittent Switch w/ Extension	#11225A...	\$377.95/ea.



DUAL WINDSHIELD WIPER KITS

These kits feature 2-speeds and a standard 72-inch drive cable. Motor mounts under the dash.

1955-57 Intermittent Switch	#2776.....	\$309.95/kit
1955-57 (Shown)	#2777.....	\$362.95/kit

WIPER TRANSMISSIONS

Planning on retaining the factory wiper drive system? These new wiper transmissions are a must. No more searching for usable cores or dealing with damaged or stretched cables. These units replace your original wiper transmissions.



1955-56	#18107.....	\$240.95/pr.
1957.....	#18108.....	\$240.95/pr.

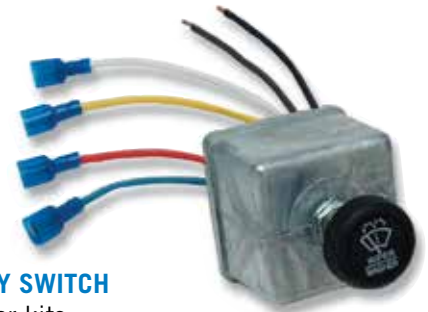

INTERMITTENT DELAY SWITCH

For aftermarket wiper kits.

1955-57	#11226.....	\$117.95/ea.
---------------	-------------	--------------

#12221



#12321



BEL AIR WINDSHIELD WIPER KNOBS

1955.....	#12221.....	\$13.95/ea.
1956.....	#12321.....	\$17.95/ea.
1957.....	#886.....	\$14.95/ea.



1957 WIPER SWITCH CONTROL CABLE ASSEMBLY

1957 w/ Stainless Cable	#16601.....	\$79.95/ea.
-------------------------------	-------------	-------------



TRICO VACUUM WIPER MOTOR GASKETS

1955-57	#11219.....	\$3.75/kit
---------------	-------------	------------

WIPER SWITCH RETAINER NUTS

This often missing retainer is now available, Be sure to order the correct tool, part #913 on page 631, to install.



#17953



#15546

1955-56	#17953.....	\$12.95/ea.
1957.....	#15546.....	\$3.95/ea.

WIPER MOTOR AND DRIVE MOUNTING SCREWS

1955-57 ..	#2267 ...	\$4.95/set
------------	-----------	------------





RAINGEAR WINDSHIELD WIPER KITS

The RainGear wiper system is a rugged and proven lever and link wiper system designed to completely replace the original cable and spool system. This kit uses the original arms and blades and you can use the original knob and bezel to retain originality. Don't forget to order the optional washer kit, #12828, shown below. These kits will not clear Airtique's 1955 only defrost duct or Kugels under dash master cylinder/booster. Motor mounts under the dash.

1955-56 2-Speed	#12824.....	\$476.95/kit
1955-56 2-Speed w/ Delay	#12825.....	\$537.95/kit
1957 2-Speed	#12826.....	\$537.95/kit
1957 2-Speed w/ Delay.....	#12827.....	\$569.95/kit



WIPER TRANSMISSION SPACERS

These die cast spacers are required when re-installing the factory wiper transmission in the cowl area.

1955-56	#17683.....	\$21.95/pr.
---------------	-------------	-------------



RAINGEAR WINDSHIELD WASHER KIT

Add this washer kit to your RainGear system for a complete modern upgrade.

All.....	#12828.....	\$105.95/kit
----------	-------------	--------------

1957 WIPER MOTOR CABLE RETAINER

This mounts to the front of the wiper motor and retains the wiper control cable #16001. Also fits 1957-1962 Corvette.



1957.....	#17406.....	\$13.95/ea.
-----------	-------------	-------------

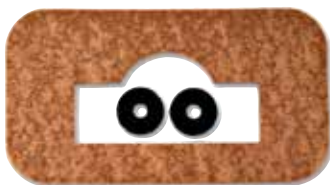

WINDSHIELD WIPER CENTER DRIVE GASKETS

Made in the USA.

1955-57	#863.....	\$7.95/set
---------------	-----------	------------

DIVISION BAR CHANNEL STOPS

Mounts at the top of the vent window frame in the division bar and acts as a stop when you roll up the window.

1955-57 2 & 4-Dr Hardtop, Conv., & Nomad

.....	#147.....	\$12.95/pr.
-------	-----------	-------------





GLASS METAL CHANNELS

There were more than one design for some channels; therefore, some of the channels listed below may not look exactly like the ones in your car. Minor modification may be necessary for some models. Channels are designed to fit all 55-57 model years. Glass setting channels, shown at right, are needed to complete your installation. For those of you who are planning to delete the Vent windows on your 2-door sedan or wagon, part #16522 will make the job easier. This setting channel is made extra long to properly fit the wider door glass on vent delete applications. Part #16522 fits both sides, two required per car.

- 1955-57 Hardtop & Conv., Front, Driver (Shown) #1011 \$24.95/ea.
- 1955-57 Hardtop & Conv., Front, Psngr. (Shown) #1012 \$24.95/ea.
- 1955-57 Nomad, Driver #1013 \$24.95/ea.
- 1955-57 Nomad, Passenger #1014 \$24.95/ea.
- 1955-57 2-Door Sedan & Wagon, Front, Driver #1015 \$21.95/ea.
- 1955-57 2-Door Sedan & Wagon, Front, Passenger #1016 \$21.95/ea.
- 1955-57 2-Door Sedan, Rear, Driver #1017 \$29.95/ea.
- 1955-57 2-Door Sedan, Rear, Passenger #1018 \$29.95/ea.
- 1955-57 2-Door Sedan & Wagon, Vent Delete, Both Sides #16522 \$21.95/ea.
- 1955-57 2-Door Wagon, Rear, Driver #11301 \$25.95/ea.
- 1955-57 2-Door Wagon, Rear, Passenger #11302 \$25.95/ea.
- 1955-57 4-Door Sedan & Wagon, Front, Driver #1019 \$19.95/ea.
- 1955-57 4-Door Sedan & Wagon, Front, Passenger #1020 \$19.95/ea.
- 1955-57 4-Door Sedan & Wagon, Rear, Driver #1021 \$19.95/ea.
- 1955-57 4-Door Sedan & Wagon, Rear, Passenger #1022 \$19.95/ea.

QUARTER GLASS TRACK "L" STOP

This mounts on the quarter glass channel and keeps the glass from moving too far in the channel keeping the glass in place. One per side, two per car required.



- 1955-57 2-Door Hardtop & Sedan #12705 \$12.95/ea.



GLASS SETTING CHANNELS



The glass setting channel is an absolute must when installing glass. With this important part, glass can be safely and securely pressure-fitted into the glass metal channel, shown at right. One set per car required. **Made in the USA.**

- 1955-57 Sedan & Wagon (Shown) #842 \$26.95/set
- 1955-57 2-Door Hardtop & Conv. . #843 \$26.95/set
- 1955-57 Nomad #844 \$26.95/set



REAR OF DOOR VERTICAL GLASS RUN CHANNELS

This is the guide channel that mounts inside of the door and gets lined with fur channel material.

- 1955-57 2-Door Hardtop & Conv. Driver #15990 \$38.95/ea.
- 1955-57 2-Door Hardtop & Conv. Passenger #15991 \$35.95/ea.



REAR GLASS DRAIN SEALS

- 1955-56 Sedan #815 \$14.95/pr.
- 1956-57 4-Door Hardtop, Trim to Fit '57 Sedan #816 \$14.95/pr.

REAR GLASS TRACK ADJUSTMENT BOLT

This specially designed bolt assembly secures the short and long inner quarter window glass tracks to the inner quarter panels and allows for adjustment of the quarter windows.



- 1955-57 Hardtop #17409 \$7.95/ea.



#11337



#11338



#11339



#11340

GLASS TRACK ROLLER GUIDES

These mount to the glass metal channels and the window rollers run inside. Part #11340 can also be used on 2-door wagon with minor modifications.

1955-57 Front, 2-Door	#11337.....	\$23.95/ea.
1955-57 Rear Quarter, 2-Door Sedan & Wagon	#11338.....	\$23.95/ea.
1955-57 Front, 4-Door Sedan & Wagon	#11339.....	\$24.95/ea.
1955-57 Rear, 4-Door Sedan & Wagon	#11340.....	\$24.95/ea.



1957 BOTTOM WINDSHIELD GASKET CHANNELS

1957 2-Piece.....	#17907.....	\$61.95/pr.
-------------------	-------------	-------------



WINDOW ROLLER GUIDES WITH HARDWARE

1955-57 Inner, Hardtop, Convertible & Nomad	#14970.....	\$11.95/ea.
1955-57 Hardtop, Convertible & Nomad	#2082.....	\$14.95/ea.



WINDOW ROLLER RUBBERS

Replacement rubber rollers for the inner and outer window roller guides. Set of four.

1955-57 Hardtop, Convertible, & Nomad	#088.....	\$7.95/set
---	-----------	------------



NOMAD DOOR GLASS UPPER WINDOW STOP KIT

1955-57 #18293.....\$23.95/kit



UPPER WINDOW STOPS

These are the rubber caps that install on the window stop metal adjusters.

1955-57 2 & 4-Door Hardtop, Conv., & Nomad #830..... \$9.95/set



INSIDE TOP WINDOW STOP SET

These mount inside the door at the top and act as a stop for the window and allow for adjustment to the upward travel. One set required per door. Hardtop and convertible only, will not work on sedans.

1955-57 Hardtop & Convertible.... #2193..... \$27.95/set



WINDOW BOTTOMING STOPS

These are located inside the door at the bottom. They install in a bracket in the door and keep the window from clunking when rolled down.

1955-59 Hardtop & Conv. (Shown) #184.....\$8.95/pr.
1955-59 Sedan & Wagon..... #16695.....\$3.95/pr.



INSIDE WINDOW STOP KITS

These mount inside the door at the top and act as a stop for the window and allow for adjustment to the upward travel. One set required per front door, two sets required per car. One set required for rear doors, two sets required per car.

1956-57 4-Door Hardtop, Front Doors #18294.....\$23.95/kit

1956-57 4-Door Hardtop, Rear Doors #18295.....\$11.95/kit



PHOTO COURTESY OF GERTMAN2000



CONVERTIBLE QUARTER WINDOW PIVOT ASSEMBLY

Provides mounting and pivot points for the chrome quarter window frames. Comes with pivot brackets, adjuster plates, studs, bolts and washers. One set required.

1955-57 #15218.....\$271.95/pr.



QUARTER WINDOW WEATHERSTRIP RETAINER

1955-57 Hardtop & Convertible.... #11354.....\$24.50/ea.



CHROME REAR QUARTER WINDOW UPPER FRAMES

1955-57 2-Door Hardtop..... #11299.....\$64.95/ea.

1955-57 Convertible..... #2190.....\$91.95/ea.

CONVERTIBLE QUARTER WINDOW ADJUSTING PLATES

Fits between the pivot assembly and the inner quarter panel.

1955-57 Driver..... #11229.....\$18.95/ea.

1955-57 Passenger #11230.....\$18.95/ea.



QUARTER WINDOW RIVETS

1955-57 Hardtop & Convertible.... #12717.....\$4.25/set

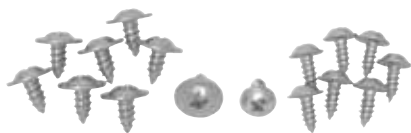

INNER QUARTER WINDOW CURVED MOULDING SCREWS

1955-57 2-Door Hardtop..... #19303.....\$3.95/set

#854



#855

REAR QUARTER WINDOW STOPS

These rear window stops mount in the opening on the "B" pillar at the top by the belt area above the door striker plate. #854 includes the metal steel insert. One set required per car.

1955-57 2-Door Hardtop..... #854.....\$20.95/pr.

1955-57 Conv. #855.....\$14.95/pr.

QUARTER PANEL, QUARTER GLASS "L" STOP

This quarter glass 'L' stops installs on the inner quarter and helps keep the quarter glass in place. Sold as each, two needed per car. Includes the bracket, square nut, bolt and lock washers.

1955-57 2-Door Hardtop..... #18029\$9.95/ea.



REAR QUARTER DRAIN AND UPPER RUBBER STOP BUMPERS

These mount in the top of the quarter at the rear of the window opening. They mount down in the channel of the body. One pair needed per car.

1955-57 Convertible..... #856.....\$32.95/set



NOMAD AND WAGON CURVED QUARTER GLASS RETAINER CLIPS

1955-57 Upper, 8-Piece #15430.....\$21.95/set

1955-57 Lower, 10-Piece #15431\$24.95/set



CHROME QUARTER WINDOW FRAMES O/S

1955-57 2-Door Hardtop, Upper & Lower.....	#12370.....	\$459.95/set
1955-57 Best, Convertible, Upper & Lower	#16813.....	\$399.95/set
1955-57 Good, Convertible, Upper & Lower	#12371.....	\$349.95/set

#17922



#17923

#17921

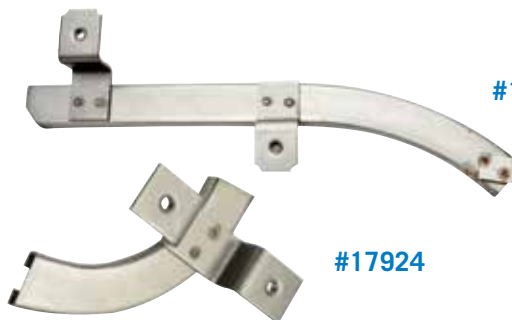

#17924

REAR QUARTER GLASS TRACKS

Installs in the rear quarters and guides the quarter windows on 2-door hardtops and sedans.

1955-57 Hardtop, Small, Driver.... #17921.....	\$33.95/ea.	1955-57 Hardtop, Long, Driver..... #18721.....	\$44.95/ea.
1955-57 Hardtop, Small, Psngr. ... #17922.....	\$33.95/ea.	1955-57 Hardtop, Long, Psngr..... #18722.....	\$44.95/ea.
1955-57 Sedan, Small, Driver..... #17923.....	\$29.95/ea.	1955-57 Sedan, Long, Driver..... #18723.....	\$44.95/ea.
1955-57 Sedan, Small, Passenger #17924.....	\$29.95/ea.	1955-57 Sedan, Long, Passenger. #18724.....	\$44.95/ea.

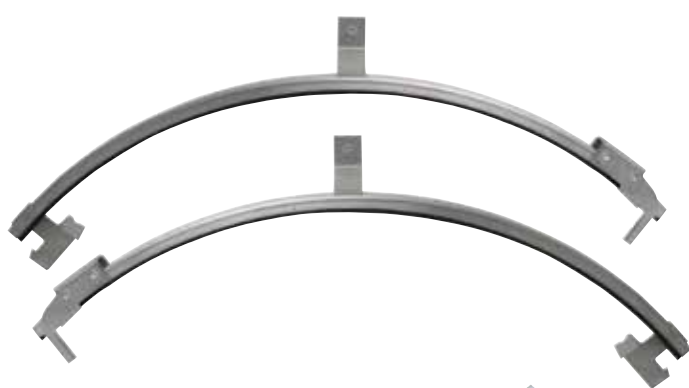

CONVERTIBLE QUARTER WINDOW TRACKS



These window tracks come fully lined and ready for installation. **Made in the USA.**

1955-57 Stainless..... #17309..... \$225.95/pr.



CONVERTIBLE QUARTER WINDOW TRACKS



This curved quarter channel guide mounts inside the rear quarter and guides quarter window down inside rear body and comes with the felt liner installed.

1955-57 Driver..... #16479..... \$124.95/ea.
 1955-57 Passenger..... #16480..... \$124.95/ea.



VENT WINDOW ASSEMBLIES

These are complete vent window assemblies which includes the fixed window frame, vent window frame, tinted or smoked vent window glass vertical run channels and the vent window seal.

- 1955-57 Hardtop, Clear, Driver #18179 \$359.95/ea.
- 1955-57 Hardtop, Clear, Psngr..... #18180 \$359.95/ea.
- 1955-57 Hardtop, Tinted, Driver #18953 \$359.95/ea.
- 1955-57 Hardtop, Tinted, Psngr #18954 \$359.95/ea.
- 1955-57 Hardtop, Smoked, Driver #18955 \$359.95/ea.
- 1955-57 Hardtop, Smoked, Psngr..... #18956 \$359.95/ea.
- 1955-57 Sedan & Wagon, Clear, Driver #17431 \$359.95/ea.
- 1955-57 Sedan & Wagon, Clear, Psngr..... #17432 \$359.95/ea.
- 1955-57 Sedan & Wagon, Tinted, Driver..... #18961 \$359.95/ea.
- 1955-57 Sedan & Wagon, Tinted, Psngr #18962 \$359.95/ea.
- 1955-57 Sedan & Wagon, Smoked, Driver .. #18963 \$359.95/ea.
- 1955-57 Sedan & Wagon, Smoked, Psngr .. #18964 \$359.95/ea.
- 1955-57 Conv., Clear, Driver #18268 \$359.95/ea.
- 1955-57 Conv., Clear, Psngr #18269 \$359.95/ea.
- 1955-57 Conv., Tinted, Driver #18957 \$359.95/ea.
- 1955-57 Conv., Tinted, Psngr..... #18958 \$359.95/ea.
- 1955-57 Conv., Smoked, Driver..... #18959 \$359.95/ea.
- 1955-57 Conv., Smoked, Psngr #18960 \$359.95/ea.
- 1955-57 Nomad, Clear, Driver..... #18900 \$359.95/ea.
- 1955-57 Nomad, Clear, Psngr #18901 \$359.95/ea.
- 1955-57 Nomad, Tinted, Driver #18965 \$359.95/ea.
- 1955-57 Nomad, Tinted, Psngr..... #18966 \$359.95/ea.
- 1955-57 Nomad, Smoked, Driver..... #18967 \$359.95/ea.
- 1955-57 Nomad, Smoked, Psngr #18968 \$359.95/ea.



OUTER VENT WINDOW FRAMES

These reproduction fixed, vent window frames fit hardtop and convertible models come with the rubber vent window seal.

- 1955-57 Hardtop & Conv., Driver #18637..... \$179.95/ea.
- 1955-57 Hardtop & Conv., Psngr . #18638..... \$179.95/ea.

OUTER VENT WINDOW FRAMES

- 1955-57 2 & 4-Door Sedan, Wagon, Driver #17234..... \$119.95/ea.
- 1955-57 2 & 4-Door Sedan, Wagon, Passenger #17235..... \$119.95/ea.



VENT DELETE WINDOW CHANNEL KITS

Vent window delete has become the trend on both 2 and 4-door sedans and wagons. One kit does both sides, not available for hardtop models. Ground shipping only.

1955-57 2-Door	#16640.....	\$89.95/kit
1955-57 4-Door	#16641.....	\$89.95/kit



VENT WINDOW FRAMES

1955-57 w/ Latch, Sdn. & Wagon. #11210.....	\$152.95/pr.
1955-57 w/ Latch, HT & Nomad ... #11212.....	\$134.95/pr.
1955-57 Convertible..... #11213.....	\$99.95/pr.



VENT WINDOW VERTICAL MOULDINGS

1955-57 HT, Conv. & Nomad, Driver .. #17917 ..	\$48.95/ea.
1955-57 HT, Conv. & Nomad, Psngr... #17918 ..	\$48.95/ea.
1955-57 Sedan & Wagon, Driver	#17919 .. \$48.95/ea.
1955-57 Sedan & Wagon, Psngr. #17920 ..	\$48.95/ea.



VENT WINDOW LATCH ASSEMBLY

1955-57 exc. Convertible	#10251	\$29.95/pr.
---------------------------------------	---------------------	--------------------

VENT WINDOW VERTICAL FRAME CHANNELS WITH FELT AND SEAL

1955-57 Hardtop & Conv., Driver ... #18266 ..	\$115.95/ea.
1955-57 Hardtop & Conv., Psngr. #18267 ..	\$115.95/ea.
1955-57 Sedan, Driver	#18413 .. \$115.95/ea.
1955-57 Sedan, Passenger..... #18414 ..	\$115.95/ea.



VENT WINDOW FRAME CAPS

- 1955-57 2-Door Hardtop, 1955 Convertible & Nomad #15514..... \$21.95/ea.
- 1956-57 4-Door Hardtop, Convertible & Nomad #16953..... \$54.95/pr.
- 1956-57 4-Door Hardtop, Convertible & Nomad, Driver #16954..... \$29.95/ea.
- 1956-57 4-Door Hardtop, Convertible & Nomad, Psngr. #16955..... \$29.95/ea.



VERTICAL WINDOW SEALS

These seals slide into the channel in the rear quarter window and seal the quarter window to the door window keeping out wind, dirt and rain. These can be trimmed to fit 56-57 4-door hardtops. **Made in the USA.**

- 1955-57 2-Door Hardtop & Convertible (Shown) #566..... \$10.95/pr.



VENT WINDOW ASSEMBLY SCREWS

- 1955-57 Hardtop, Conv & Nomad. #15422 \$12.95/set
- 1955-57 Sedan & Wagon..... #15423..... \$4.95/set



VENT WINDOW FRAME LOCK AND PIVOT BRACKET RIVETS

- 1955-57 #12718..... \$2.95/set



VENT WINDOW SEALS

Danchuk vent window seals are made from the finest rubber formulas available today and are an exact fit to the factory originals.

- 1955-57 Best, Hardtop, Convertible & Nomad #565..... \$69.95/set
- 1955-57 Good, Hardtop, Convertible & Nomad #16710..... \$52.95/set
- 1955-57 Best, Sedan & Wagon (Shown) #565A..... \$69.95/set
- 1955-57 Good, Sedan & Wagon ... #16711 \$52.95/set



SIDE AND VENT WINDOW FRAME SCREWS

- 1955-57 Hardtop, Convertible & Nomad #1075..... \$4.95/set



VENT WINDOW ASSEMBLY ADJUSTER BOLTS

This is the adjuster bolt that attaches to the lower stem of the vent window assembly. One for each door required, two per car.

- 1955-57 Sedan & Wagon..... #17404..... \$9.95/ea.
- 1955-57 Hardtop, Nomad & Conv. #17405..... \$9.95/ea.



NOMAD REAR QUARTER GLASS SEALS

1955-57 #651 \$6995.00/pr.

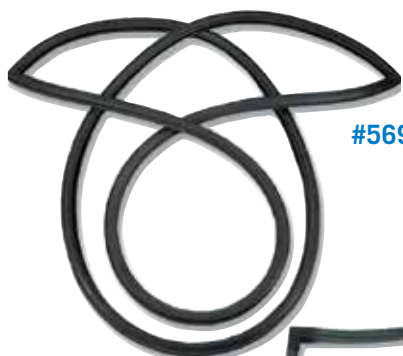

#569



#627



WAGON REAR QUARTER GLASS SEALS

Made in the USA.

1955-57 2-Door Wagon #849 \$64.95/pr.
 1955-57 4-Door Wagon (Shown) .. #850 \$69.95/pr.



REAR WINDOW SEALS

When you replace the glass or paint your car you need to replace the window seals too. Our top quality seals are designed to outlast the originals. **Made in the USA***.

1955 2 & 4-Door 150 Sedan #572* *\$54.95/ea.
 1955 2 & 4-Door 210 & Bel Air Sedan #570* \$52.95/ea.
 1956-57 Sedan #839 \$69.95/ea.
 1956-57 4-Door Hardtop #569A* \$59.95/ea.
 1955-57 2-Door Hardtop (Shown). #569* \$52.95/ea.
 1955-57 Wagon & Sedan Delivery #571* \$26.95/ea.
 1955-57 Nomad (Shown) #627 \$35.95/ea.



LOWER DOOR DRAIN SEALS

These seals are removed to drain the water out of the door. If your seals are rotted, painted over or missing, we've got your replacements. Clips are included. Two sets required for 4-door models. **Made in the USA.**

1955-57 #841 \$11.95/set



REAR QUARTER SIDE GLASS SEAL

This seal is designed to replace the stationary rear and center rear windows on the 150 and 210 models. **Made in the USA.**

1955-57 4-Door Sedan #997 \$79.95/pr.

WARNING! Products on these pages may contain chemicals known to the State Of California to cause cancer and/or birth defects or reproductive harm. www.p65warnings.ca.gov



TRUNK SEALS

#563



Our trunk seals all require glue-in installations, just like the originals. For an excellent bond, we recommend 3M weatherstrip adhesive. In 1957, Chevy added nylon fastening clips to the design for more secure positioning. Our reproduction weatherstrip includes this important upgrade. Careful research, state-of-the-art rubber formulas, and precision tooling make these Danchuk seals the best value available. **Made in the USA*.**

1955-56 Best.....	#562*	\$34.95/ea.
1955-56 Good.....	#16779	\$19.95/ea.
1957 Best.....	#563*	\$35.95/ea.
1957 Good.....	#16780	\$22.95/ea.



DOOR SEALS WITH MOLDED ENDS

Our modern rubber formulas ensure that you are buying the longest lasting seal available. This 100% accurate door seal is held in position by nylon fasteners. Stamped steel supports are molded into the end clips, just like they were designed by Chevrolet. This show quality part is as close as you can get to the original. We recommend using 3M weatherstrip adhesive for installation. **Made in the USA.**

1955-57 Best, 2-Door Hardtop & Convertible (Shown)	
.....	#914..... \$119.95/pr.
1955-57 Nomad.....	#2091..... \$78.95/pr.
1956-57 4-Door Hardtop, Front	#12264..... \$82.95/pr.
1956-57 4-Door Hardtop, Rear	#12265..... \$82.95/pr.

REAR LIFTGATE SEAL



Designed for the sedan delivery, this seal includes the original-style fastening clips. We recommend using 3M weatherstrip adhesive for installation.



Made in the USA.

1955-57	#039.....	\$26.95/ea.
---------------	-----------	-------------



DOOR SEALS WITH CLIPS

Our 100% accurate reproduction door seals fit all 1955, 1956, and 1957 Chevy sedans and wagons. They seal the doors just as well, and include the nylon fasteners that hold the seal in place, but lack the molded ends used on the original 2-door hardtop and convertible door seal (#914). For 4-door models, you will need two sets. All Danchuk seals are manufactured with the best rubber, tooling, and craftsmanship available. We recommend using 3M weatherstrip adhesive for installation. **Made in the USA*.**

1955-57 Best, Sedan & Wagon, 55-57 Truck	
.....	#552*..... \$64.95/pr.
1955-57 Good, Sedan & Wagon, 55-57 Truck	
.....	#16708..... \$31.95/ea.
1955-57 Hardtop, Convertible & Nomad	
.....	#553*..... \$64.95/pr.



3M BLACK SUPER WEATHERSTRIP ADHESIVE

Bonds gaskets and weatherstripping to metal surfaces. It withstands vibration and temperature changes; resists oils, fuels, detergents and grease to provide a strong and flexible bond. Danchuk recommends 3M weatherstrip adhesive always be used when you replace your door and trunk seals. 5 oz. tube. Ground shipping only.

All 5 oz	#036.....	\$13.95/ea.
----------------	-----------	-------------



ROOF RAILS  O/S

Seal out that wind, water, dirt, and noise with these beautiful rubber seals. In our never-ending struggle for perfection, we made "Class A" tooling for our Nomad & Safari (#296) seals. These incredible seals are made of the highest quality USA rubber and, of course, fitted with the original style metal inserts. We give these seals our highest quality control rating and we are certain you will too. **Made in the USA.**

1956-57 4-Door Hardtop.....	#628.....	\$299.95/pr.
1955-57 Nomad & Safari.....	#296.....	\$169.95/pr.



#223



#224



DOOR HINGE SEALS WITH CLIPS

Our new tooling has made the tolerances on this door seal 100% correct and original. We use only top quality rubber formulas on all our rubber parts. Fits along the slanted portion of the front door near the hinge. We recommend using 3M weatherstrip adhesive for installation.

1955-57	#246.....	\$16.95/pr.
---------------	-----------	-------------

RUBBER BUMPER KITS

These kits contain bumpers for the doors, trunk, glove box and hood. Nomad kits do not include tailgate bumpers, #1822, found on page 654.

1955-57 2-Door Sedan (Shown)...	#224.....	\$14.95/kit
1955-57 4-Door Sedan	#224A.....	\$20.95/kit
1955-57 2-Door Wagon	#224B.....	\$16.95/set
1955-57 4-Door Wagon	#224C.....	\$19.95/set
1955-57 2-Door Hardtop, Conv. & Nomad (Shown)		
.....	#223.....	\$14.95/kit
1955-57 4-Door Hardtop.....	#223A.....	\$15.95/kit



NOMAD VERTICAL SLIDER SEALS 

Designed specifically for Nomad slide-open side windows. **Made in the USA.**

1955-57	#1210.....	\$21.95/pr.
---------------	------------	-------------



NOMAD REAR SLIDING WINDOW AND SEAT LATCH BUMPERS

1955-57 Nomad & Safari	#814.....	\$3.95/pr.
------------------------------	-----------	------------

 **WARNING!** Products on these pages may contain chemicals known to the State Of California to cause cancer and/or birth defects or reproductive harm. www.p65warnings.ca.gov



SEDAN DELIVERY REAR DOOR TORSION BARS

1955-57 #17407 \$119.95/pr.



NOMAD STAINLESS PAINT DIVIDER FILLER TRIM

1956..... #18332..... \$158.95/pr.



NOMAD VERTICAL SLIDER GLASS MOULDINGS

1955-57 #14700..... \$129.95/pr.

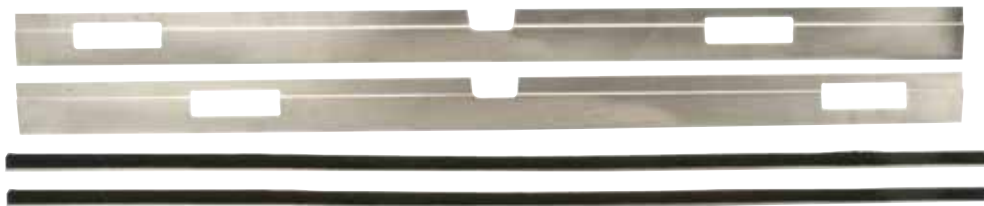

NOMAD DOOR ANTI-RATTLE TRIM AND FUR STRIPS

Although not original, these add-on anti-rattle trim and fur strips will help minimize door glass rattle. Originally, the front doors on the Nomad only had a fur strip on the inside of the door against the glass. These install on the outside between the door window channel and the glass.

1955-57 #18331 \$84.95/pr.



NOMAD STAINLESS WINDOW FUR CHANNEL SLIDER BRACKETS

These install in the sliding window channel at the rear of the curved rear window on the inside. They include the slider stop, part #814.

1955-57 Nomad & Safari #15021 \$43.95/pr.



#18329

NOMAD REAR INTERIOR WINDLACE GARNISH
1955-57 #18329 \$99.95/pr.



#15027

NOMAD STAINLESS, REAR QUARTER GLASS BRACKETS
With minor modifications these brackets will work on all station wagons.
1955-57 Inside, Lower, Nomad & Safari #15027 \$79.95/pr.



NOMAD STAINLESS REAR QUARTER GLASS BRACKETS
1955-57 Inside Upper, Nomad & Safari
..... #15025 \$59.95/pr.



NOMAD GLASS SLIDER LATCHES
1955-57 Nomad & Safari #14945 \$39.95/pr.

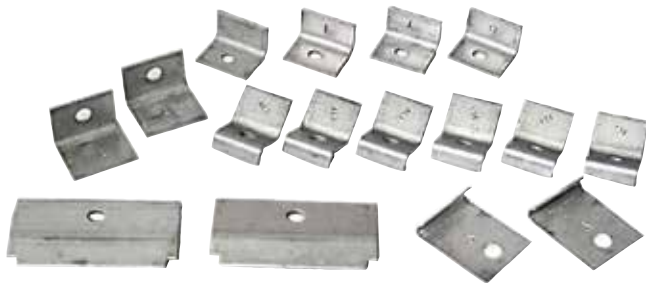

NOMAD STAINLESS WINDOW CLIPS
1955-57 Nomad & Safari #15026 \$59.95/kit



NOMAD REAR QUARTER GLASS SEALS
1955-57 #651 \$69.95/pr.



NOMAD STAINLESS SLIDER GLASS LOCK BRACKETS
1955-57 Nomad & Safari #15028 \$24.95/pr.

NOMAD SLIDER GLASS CHANNEL LOCATING CLIPS

Can be used on 150 Sedans rear stationary windows, and stationary center windows on wagons.



1955-57 6-Piece #15429 \$24.95/set



PHOTO COURTESY OF GERTMAN2000



NOMAD AND WAGON STAINLESS LIFTGATE ANTI-RATTLE TRIM WITH CNC STRIKER O/S

Custom one-piece design eliminates the rivets for the center striker plate, which is the primary cause of liftgate rattling. The 14 gauge trim is stamped with factory bends and includes adjustment plate on the backside for the striker. Piece comes with all stainless hardware and Dynamat for additional sound deadening ready to install. CNC machined stainless striker is polished and comes with stainless hardware. Will not break or chip like original potmetal strikers.
 1955-57 #18333..... \$335.95/ea.

LIFTGATE



NOMAD AND WAGON CNC MACHINED STAINLESS LIFTGATE STRIKERS

1955-57 Polished..... #18325.....\$117.95/pr.



#17608



#17609

NOMAD & WAGON CHROME LIFTGATE SUPPORTS

1955-57 Wagon #17608.....\$199.95/pr.
 1955-57 Nomad #17609.....\$199.95/pr.



NOMAD AND WAGON LIFTGATE GUIDE

1955-57, Nomad, Wagon & Safari #15024..... \$84.95/ea.



NOMAD CARGO AREA ACCESS COVER

1955-57 #17413.....\$7.95/ea.



NOMAD SIDE WINDOW MOULDING SCREWS

1955-57 60-Piece..... #15425 \$7.95/set



NOMAD AND WAGON CARGO AREA ASSEMBLY KIT

1955-57 256-Piece..... #11307.....\$26.95/kit



NOMAD INNER LIFTGATE WINDOW FRAME SCREWS

1955-57 56-Piece..... #15428 \$9.95/set



NOMAD AND WAGON POLISHED STAINLESS LIFTGATE GAS STRUT KITS

Convert your original locking liftgate arms to these polished stainless liftgate gas struts. Stainless brackets and screws included.

1955-57 Nomad	#18339.....	\$255.95/kit
1955-57 Wagon	#18340.....	\$255.95/kit



NOMAD & WAGON POLISHED STAINLESS LIFTGATE RUBBER RETAINERS

This is the piece that installs on the vertical stainless on the rear C-pillar to the left and right side of the liftgate. These keep the liftgate rubber from pulling out of the channel.

1955-57	#18330.....	\$94.95/pr.
---------------	-------------	-------------



LIFTGATE ARM REBUILD KIT

All the parts you need to rebuild your lift gate arms (supports) back to their original state. All parts are dimensionally accurate and the support tabs are chrome plated per the original design. **Made in the USA.**

1955-57 Nomad & Wagon.....	#1463.....	\$18.95/kit
----------------------------	------------	-------------



NOMAD UPPER LIFTGATE TABS

Located on the ends of the upper liftgate, these reproduction tabs look like the originals and fit like them too!

1955-57	#613.....	\$19.95/pr.
---------------	-----------	-------------

#199



#183

LIFTGATE STOP RUBBER BUMPERS

Protects the lower tailgate if the liftgate is accidentally closed over it.

1955-57 Wagon	#183.....	\$5.95/ea.
1955-57 Nomad	#199.....	\$8.95/pr.



STAINLESS LIFTGATE SCREW KIT

1955-57 Nomad & Safari	#15029.....	\$64.95/kit
------------------------------	-------------	-------------



LIFTGATE WINDOW RETAINER CLIPS

1955-57 exc. Nomad, 4-Piece	#15432	\$23.95/set
-----------------------------------	--------------	-------------



WAGON TAILGATE HINGES

1955-57 #17898.....\$132.95/pr.



#18324



BILLET ALUMINUM TAILGATE HINGES WITH STAINLESS HARDWARE

1955-57 Nomad #18323.....\$299.95/pr.

1955-57 Wagon #18324.....\$299.95/pr.



NOMAD TAILGATE HINGE COVERS

1955-57 Stainless..... #18436.....\$150.95/pr.



NOMAD AND WAGON TAILGATE HINGE TRIM

Finishes the raw edge of the tailgate skin at the lower hinges. Snaps in as original.

1955-57 #16889.....\$59.95/pr.

1955-57 Polished Stainless #18328.....\$99.95/pr.

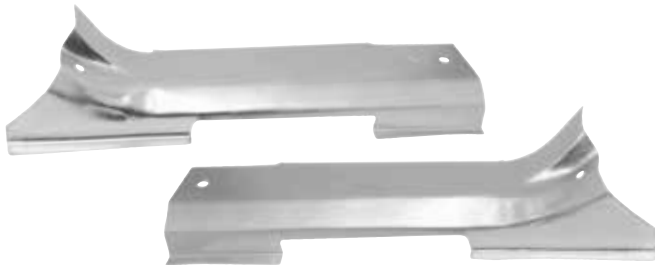

WAGON TAILGATE HINGE COVERS

This reproduction of the original, mounts on the tailpan and covers the hinge screws.

1955-57 #16877.....\$81.95/pr.



LOWER TAILGATE HINGE COVERS

1955-57 Nomad, Wagon & Safari. #15020.....\$24.95/pr.

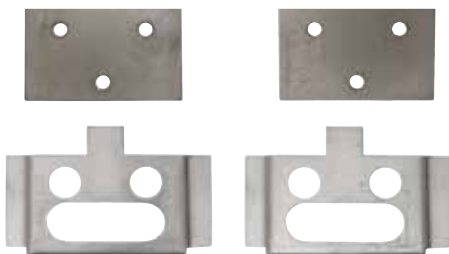

NOMAD AND WAGON LOWER TAILGATE HINGE MOUNTING PLATES

A complete set of replacement lower tailgate mounting plates. Retainers will require welding to install.

1955-57 w/ Holders..... #17679.....\$99.95/pr.



NOMAD INNER TAILGATE STAINLESS TRIM

1955-57 5-Piece..... #18336..... \$225.95/set

STAINLESS TAILGATE LATCHES

These brand new tailgate latches are machined out of stainless steel and polished to a show quality shine. Comes complete with stainless rods, clips and stainless hardware.

1955-57 Nomad w/ Rods & Hardware #18455 \$249.95/pr.
 1955-57 Wagon w/ Rods & Hardware #18456 \$249.95/pr.



LOWER TAILGATE HANDLE TO LATCH RODS

These often missing parts are now available in a kit that includes the rods and clips to connect the tailgate handle to the latches.

1955-57 Nomad w/ Clips #15539..... \$21.95/kit

STAINLESS TAILGATE LATCH RODS

1955-57 Wagon & Sedan Delivery w/ Clips..... #18341..... \$49.95/ea.

NOMAD AND WAGON TAILGATE LATCHES

These brand new latches include the spring, latch and brilliantly chrome plated housing.

1955-57 #18498..... \$129.95/pr.



#1247

NOMAD TAILGATE CLIPS

Sold in five piece sets, these clips securely mount the unique "bananas", found exclusively on the Nomad. See the Exteriors section for the tailgate bars. One set does one bar. Seven sets required.

1955-57 One Bar, 5-Piece #1247 \$16.95/set
 1955-57 Complete, 33-Piece #15426 \$79.95/set



#15428

TAILGATE ROD CLIPS

These clips attach the tailgate latch rods at both ends and are often rusty, damaged or missing. One set required.

1955-57 Nomad, Lower #15540..... \$3.50/set





LIFTGATE AND TAILGATE SEALS



This part fits both the liftgate and the tailgate on all wagons, and the tailgate on Nomads. We recommend using 3M weatherstrip adhesive for installation. Two seals required for wagons and one required for Nomads. **Made in the USA.**
 1955-57 #615..... \$34.95/ea.



NOMAD AND WAGON TAILGATE STRIKERS & LATCHES

1955-57 #18781..... \$179.95/pr.



WAGON UPPER LIFTGATE SEAL

1955-57 w/ Correct Molded Ends

..... #14150..... \$72.95/ea.



NOMAD AND WAGON TAILGATE STRIKERS

1955-57 Stainless w/ Hardware ... #18791..... \$249.95/pr.
 1955-57 Chrome #18780..... \$69.95/pr.



NOMAD LIFTGATE SEAL

This weatherstrip is applied to the body opening. We recommend using 3M weatherstrip adhesive for installation.

1955-57 #614..... \$35.95/ea.

#16832



NOMAD AND WAGON TAILGATE STRIKER COVERS

The striker cover finishes off the tailgate and replaces missing or damaged originals.

1955-57 Chrome #16832..... \$33.95/ea.
 1955-57 Stainless..... #17598..... \$41.95/ea.

REAR LIFTGATE SEAL



Designed for the sedan delivery, this seal includes the original-style fastening clips. We recommend using 3M weatherstrip adhesive for installation. **Made in the USA.**

1955-57 Sedan Delivery #039..... \$26.95/ea.



NOMAD LIFTGATE WEATHERSTRIP

This weatherstrip was originally applied to Nomad liftgates by dealers as a repair part. We recommend using 3M weatherstrip adhesive for installation.

1955-57 #2036..... \$9.95/ea.



TAILGATE SEALS

These tailgate seals feature molded corners.

1955-57 Nomad #11222 \$74.95/ea.
 1955-57 Wagon #11223 ... \$72.95/ea.



NOMAD AND WAGON BILLET STAINLESS TAILGATE CABLE GUIDES W/ SCREWS

These polished stainless tailgate cable guides will outlast any chromed reproduction or originals. Machined from billet 304 stainless for strength and longevity. Opening and closing the tailgate a thousand times with these installed showed very minimum wear. Includes installation hardware. Will also fit Safari. Sold as a pair, 1 pair needed per car.
1955-57 #18904.....\$249.95/pr.



LOWER TAILGATE BALL COVERS WITH CLIPS

1955-57 Nomad, Wagon & Safari #15023..... \$62.95/ea.

NOMAD AND WAGON STAINLESS TAILGATE CABLE BALLS AND BALL COVERS

1955-57 w/ Stainless Hardware ... #18322..... \$129.95/pr.



LOWER TAILGATE BALLS

1955-57 Nomad, Wagon & Safari. #15022.....\$59.95/pr.



NOMAD AND WAGON TAILGATE CABLE RETRACTOR

Danchuk reproduces these exactly per original right here in the USA. We added a zinc plate on the housing for corrosion protection. **Made in the USA.**

1955-57 #1058.....\$57.95/ea.
1955-57 Cable Clevis Pin #1058AA.....\$4.95/ea.

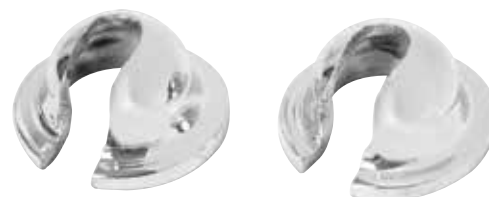

NOMAD AND WAGON CABLE GUIDES

These are the cast iron guides that bolt into the rear body to guide the tailgate cables.

1955-57 #17408.....\$44.95/pr.

TAILGATE CABLES

Replace your worn and frayed originals with these beautiful Danchuk reproductions, correct in every detail. **Made in the USA.**

1955-57 Nomad, 45-1/2" #221 \$29.95/ea.
1955-57 Wagon, 36-3/4" #221A..... \$34.95/ea.



NOMAD AND WAGON TAILGATE REEL BRACKETS

These mount on the inside wall above the rear wheel wells, right behind the rear seat. The tailgate retractors, #1058 bolt to these brackets.

1955-57 #17412.....\$29.95/pr.

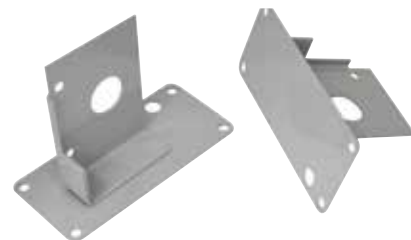

TAILGATE & LIFTGATE FASTENERS

These tailgate and liftgate fastener sets include fasteners for almost everything on the tailgate and liftgate, including the hinge screw (also sold as #2065, shown below) and latch and cable opening screws (also sold as #2052, shown below). This 126-piece set includes bolt and screw locations and uses stainless bolts where chrome was originally used.



- 1955-57 #17630..... \$26.95/set
- 1955-57 Wagon #2063..... \$27.95/set

TAILGATE SCREWS

This handy set mounts the tailgate latches to the tailgate, the striker plates to the body, and the tailgate cable openings to both the tailgate and the body. All hardware is stainless steel. Includes 24 screws and lock washers.



- 1955-57 Nomad & Wagon..... #2052..... \$15.95/set



TAILGATE FASTENERS

- 1955-57 Sedan Delivery #11308.....\$11.95/kit



TAILGATE HINGE TO BODY AND HINGE TO TAILGATE SCREWS

Enough for one hinge.
 1955-57 Nomad & Wagon..... #2065..... \$6.25/set



NOMAD AND WAGON INNER TAILGATE ACCESS COVERS

- 1955-57 Polished Stainless..... #18327..... \$99.95/ea.
- 1955-57 Chrome #18383..... \$59.95/ea.



LOWER TAILGATE BUMPER BRACKET ASSEMBLY

- 1955-57 Nomad, Wagon & Sedan Del. #18320..... \$9.95/ea.

WAGON TAILGATE WEDGES WITH SPRINGS

These are the plastic wedges with the springs that install at the center of the tailgate under the chrome tailgate access cover.



- 1955-57 #14699.....\$9.95/pr.

WAGON TAILGATE WEDGE SPRINGS

- 1955-57 #18162..... \$2.50/pr.

1955-56-57 GLASS

Glass is available in clear, factory light green tinted and a 30% Gray smoked tint (10% smoked tint on the windshields). All glass orders are drop shipped directly from our supplier to you. If you are sending in a check or money order for payment please call for a freight quote before ordering. Glass marked with an (*) are date coded and require your car's VIN#.



FOR SMOKED GLASS ADD AN "S" AFTER APPLICABLE TINTED PART NUMBER. SMOKED GLASS NOT AVAILABLE WITH DATE CODE.

DATE CODED GLASS

WINDSHIELD GLASS FOR 1955-56'S

Hardtop, Conv, Nomad, Clear.....	#11048	\$209.95/ea.
HT, Conv, Nomad, Tinted.....	#11049	\$209.95/ea.
Hardtop, Conv, Nomad, Clear.....	#11050*	\$299.95/ea.
HT, Conv, Nomad, Tinted.....	#11051*	\$299.95/ea.
Sedan, Wagon, Clear.....	#11052	\$209.95/ea.
Sedan, Wagon, Tinted.....	#11053	\$209.95/ea.
Sedan, Wagon, Clear.....	#11054*	\$299.95/ea.
Sedan, Wagon, Tinted.....	#11055*	\$299.95/ea.

WINDSHIELD GLASS FOR 1957'S

Hardtop, Conv, Nomad, Clear.....	#11056	\$209.95/ea.
HT, Conv, Nomad, Tinted.....	#11057	\$209.95/ea.
Hardtop, Conv, Nomad, Clear.....	#11058*	\$299.95/ea.
HT, Conv, Nomad, Tinted.....	#11059*	\$299.95/ea.
Sedan, Wagon, Clear.....	#11060	\$209.95/ea.
Sedan, Wagon, Tinted.....	#11061	\$209.95/ea.
Sedan, Wagon, Clear.....	#11062*	\$299.95/ea.
Sedan, Wagon, Tinted.....	#11063*	\$299.95/ea.

VENT WINDOW GLASS FOR 1955-57'S

Hardtop, Conv., Nomad, Clear.....	#10940	\$29.95/ea.
HT, Conv., Nomad, Tinted.....	#10941	\$29.95/ea.
HT, Conv, Nomad, Tinted.....	#10942*	\$74.95/ea.
Hardtop, Conv, Nomad, Clear.....	#10943*	\$74.95/ea.
Sedan, Wagon, Clear.....	#10944	\$29.95/ea.
Sedan, Wagon, Tinted.....	#10945	\$29.95/ea.
Sedan, Wagon, Clear.....	#10946*	\$74.95/ea.
Sedan, Wagon, Tinted.....	#10947*	\$74.95/ea.

FRONT DOOR WINDOW GLASS 1955-57'S

2-Door Hardtop, Conv., Clear.....	#10952	\$59.95/ea.
2-Door Hardtop, Conv., Tinted.....	#10953	\$59.95/ea.
2-Door Hardtop, Conv., Clear.....	#10954*	\$97.95/ea.
2-Door Hardtop, Conv., Tinted.....	#10955*	\$97.95/ea.
Sedan, Wagon, Clear.....	#10956	\$59.95/ea.
Sedan, Wagon, Tinted.....	#10957	\$59.95/ea.
Sedan, Wagon, Clear.....	#10958*	\$97.95/ea.
Sedan, Wagon, Tinted.....	#10959*	\$97.95/ea.
Nomad, Clear.....	#10960	\$59.95/ea.
Nomad, Tinted.....	#10961	\$59.95/ea.
Nomad, Clear.....	#10962*	\$105.00/ea.
Nomad, Tinted.....	#10963*	\$105.00/ea.

FRONT DOOR WINDOW GLASS 1956-57'S

4-Door Hardtop, Clear.....	#10948	\$59.95/ea.
4-Door Hardtop, Tinted.....	#10949	\$59.95/ea.
4-Door Hardtop, Clear.....	#10950*	\$105.00/ea.
4-Door Hardtop, Tinted.....	#10951*	\$105.00/ea.

REAR DOOR WINDOW GLASS 1956-57'S

4-Door Hardtop, Clear.....	#10964	\$59.95/ea.
4-Door Hardtop, Tinted.....	#10965	\$59.95/ea.
4-Door Hardtop, Clear.....	#10966*	\$105.00/ea.
4-Door Hardtop, Tinted.....	#10967*	\$105.00/ea.
4-Door Sedan, Clear.....	#10968	\$59.95/ea.
4-Door Sedan, Tinted.....	#10969	\$59.95/ea.
4-Door Sedan, Clear.....	#10970*	\$105.00/ea.
4-Door Sedan, Tinted.....	#10971*	\$105.00/ea.
4-Door Wagon, Clear.....	#10972	\$59.95/ea.
4-Door Wagon, Tinted.....	#10973	\$59.95/ea.
4-Door Wagon, Clear.....	#10974*	\$105.00/ea.
4-Door Wagon, Tinted.....	#10975*	\$105.00/ea.

QUARTER GLASS FOR 1955-57'S

2-Door Hardtop, Clear.....	#10976	\$59.95/ea.
2-Door Hardtop, Tinted.....	#10977	\$59.95/ea.
2-Door Hardtop, Clear.....	#10978*	\$97.95/ea.
2-Door Hardtop, Tinted.....	#10979*	\$97.95/ea.
Convertible, Clear.....	#10980	\$59.95/ea.
Convertible, Tinted.....	#10981	\$59.95/ea.
Convertible, Clear.....	#10982*	\$97.95/ea.
Convertible, Tinted.....	#10983*	\$97.95/ea.
2-Door Sedan, Clear.....	#10984	\$59.95/ea.
2-Door Sedan, Tinted.....	#10985	\$59.95/ea.
2-Door Sedan, Clear.....	#10986*	\$97.95/ea.
2-Door Sedan, Tinted.....	#10987*	\$97.95/ea.
150 2-Dr Sedan, Fixed, Clear.....	#10984A	\$59.95/ea.
150 2-Dr Sedan, Fixed, Tinted.....	#10985A	\$59.95/ea.
150 2-Dr Sedan, Fixed, Clear.....	#10986A	\$97.95/ea.
150 2-Dr Sed., Fixed, Tinted.....	#10987A	\$97.95/ea.
4-Door Sedan, Clear.....	#10988	\$59.95/ea.
4-Door Sedan, Tinted.....	#10989	\$59.95/ea.
4-Door Sedan, Clear.....	#10990*	\$97.95/ea.
4-Door Sedan, Tinted.....	#10991*	\$97.95/ea.
150 2-Door Wagon, Clear.....	#10992	\$59.95/ea.
150 2-Door Wagon, Tinted.....	#10993	\$59.95/ea.
150 2-Door Wagon, Clear.....	#10994*	\$97.95/ea.
150-2 Door Wagon, Tinted.....	#10995*	\$97.95/ea.
210 2-Door Wagon, Clear.....	#10996	\$59.95/ea.
210 2-Door Wagon, Tinted.....	#10997	\$59.95/ea.
210 2-Door Wagon, Clear.....	#10998*	\$97.95/ea.
210 2-Door Wagon, Tinted.....	#10999*	\$97.95/ea.

SLIDER GLASS FOR 1955-57'S

Nomad, Clear.....	#11020	\$59.95/ea.
Nomad, Tinted.....	#11021	\$59.95/ea.
Nomad, Clear.....	#11022*	\$97.95/ea.
Nomad, Tinted.....	#11023*	\$97.95/ea.

REAR CURVED QUARTER GLASS 55-57'S

2-Dr Wagon, Clear, Right.....	#11024	\$299.95/ea.
2-Dr Wagon, Tinted, Right.....	#11025	\$299.95/ea.
2-Dr Wagon, Clear, Right.....	#11026*	\$350.00/ea.
2-Dr Wagon, Tinted, Right.....	#11027*	\$350.00/ea.
2-Dr Wagon, Clear, Left.....	#11028	\$299.95/ea.
2-Dr Wagon, Tinted, Left.....	#11029	\$299.95/ea.
2-Dr Wagon, Clear, Left.....	#11030*	\$350.00/ea.
2-Dr Wagon, Tinted, Left.....	#11031*	\$350.00/ea.
4-Dr Wagon, Clear, Right.....	#11032	\$299.95/ea.
4-Dr Wagon, Tinted, Right.....	#11033	\$299.95/ea.
4-Dr Wagon, Clear, Right.....	#11034*	\$350.00/ea.
4-Dr Wagon, Tinted, Right.....	#11035*	\$350.00/ea.
4-Dr Wagon, Clear, Left.....	#11036	\$299.95/ea.
4-Dr Wagon, Tinted, Left.....	#11037	\$299.95/ea.
4-Dr Wagon, Clear, Left.....	#11038*	\$350.00/ea.
4-Dr Wagon, Tinted, Left.....	#11039*	\$350.00/ea.
Nomad, Clear, Right.....	#11040	\$299.95/ea.
Nomad, Tinted, Right.....	#11041	\$299.95/ea.
Nomad, Clear, Right.....	#11042*	\$350.00/ea.
Nomad, Tinted, Right.....	#11043*	\$350.00/ea.
Nomad, Clear, Left.....	#11044	\$299.95/ea.
Nomad, Tinted, Left.....	#11045	\$299.95/ea.
Nomad, Clear, Left.....	#11046*	\$350.00/ea.
Nomad, Tinted, Left.....	#11047*	\$350.00/ea.

REAR WINDOW GLASS FOR 1955-57'S

2-Door Hardtop, Clear.....	#11004	\$299.95/ea.
2-Door Hardtop, Tinted.....	#11005	\$299.95/ea.
2-Door Hardtop, Clear.....	#11006*	\$395.00/ea.
2-Door Hardtop, Tinted.....	#11007*	\$395.00/ea.
Sedan, Clear.....	#11008	\$299.95/ea.
Sedan, Tinted.....	#11009	\$299.95/ea.
Sedan, Clear.....	#11010*	\$395.00/ea.
Sedan, Tinted.....	#11011*	\$395.00/ea.

REAR WINDOW GLASS FOR 1956-57'S

4-Door Hardtop, Tinted.....	#11001	\$299.95/ea.
4-Door Hardtop, Tinted.....	#11003*	\$395.00/ea.

LIFTGATE GLASS FOR 1955-57'S

Wagon, Clear.....	#11012	\$299.95/ea.
Wagon, Tinted.....	#11013	\$299.95/ea.
Wagon, Clear.....	#11014*	\$395.00/ea.
Wagon, Tinted.....	#11015*	\$395.00/ea.
Nomad, Clear.....	#11016	\$299.95/ea.
Nomad, Tinted.....	#11017	\$299.95/ea.
Nomad, Clear.....	#11018*	\$395.00/ea.
Nomad, Tinted.....	#11019*	\$395.00/ea.

GLASS SETS

Sets listed as assembled will include chrome frames and lower channels pre-installed, where applicable.

CONVERTIBLE GLASS SETS FOR 55-57'S

6-pc. Side Set, Clear.....	#11064	\$199.95/set
6-pc. Side Set, Tinted.....	#11065	\$199.95/set
6-pc. Side Set, Clear.....	#11066*	\$299.95/set
6-pc. Side Set, Tinted.....	#11067*	\$299.95/set

CONVERTIBLE GLASS SETS 1955-56'S

7-pc. Set, Clear.....	#11068	\$399.95/set
7-pc. Set, Tinted.....	#11069	\$399.95/set
7-pc. Set, Clear.....	#11070*	\$559.95/set
7-pc. Set, Tinted.....	#11071*	\$559.95/set

CONVERTIBLE GLASS SETS 1957'S

7-pc. Set, Clear.....	#11068A	\$399.95/set
7-pc. Set, Tinted.....	#11069A	\$399.95/set
7-pc. Set, Clear.....	#11070A	\$559.95/set
7-pc. Set, Tinted.....	#11071A	\$559.95/set

2-DOOR HARDTOP GLASS SETS FOR 1955-57'S

6-pc. Side Set, Clear.....	#11072	\$216.95/set
6-pc. Side Set, Tinted.....	#11073	\$219.95/set
6-pc. Side Set, Clear.....	#11074*	\$299.95/set
6-pc. Side Set, Tinted.....	#11075*	\$299.95/set

2-DOOR HARDTOP GLASS 1955-56'S

8-pc. Set, Clear.....	#11076	\$659.95/set
8-pc. Set, Tinted.....	#11077	\$649.95/set
8-pc. Set, Clear.....	#11078*	\$799.95/set
8-pc. Set, Tinted.....	#11079*	\$799.95/set

2-DOOR HARDTOP SETS FOR 1957'S

8-pc. Set, Clear.....	#11076A	\$649.95/set
8-pc. Set, Tinted.....	#11077A	\$649.95/set
8-pc. Set, Clear.....	#11078A	\$799.95/set
8-pc. Set, Tinted.....	#11079A	\$799.95/set

SIDE SETS WITH FRAMES FOR 1955-57'S

6-Piece, 2-Dr HT, Clear.....	#14885	\$899.95/ea.
6-Piece, Convertible, Clear.....	#14886	\$1049.95/ea.
6-Piece, 2-Dr HT, Tinted.....	#14887	\$899.95/ea.
6-Piece, Convertible, Tinted.....	#14888	\$1049.95/ea.
6-Piece, 2-Dr HT, Smoked.....	#14889	\$899.95/ea.
6-Piece, Convertible, Smoked.....	#14890	\$1049.95/ea.

4-DOOR HARDTOP SETS FOR 56-57'S

6-pc. Side Set, Clear.....	#11100	\$199.95/set
6-pc. Side Set, Tinted.....	#11101	\$199.95/set
6-pc. Side Set, Clear.....	#11102*	\$525.00/set
6-pc. Side Set, Tinted.....	#11103*	\$525.00/set

4-DOOR HARDTOP SETS FOR 1956'S

7-pc. Set, Clear.....	#11104	\$459.95/set
8-pc. Set, Tinted.....	#11105	\$659.95/set
7-pc. Set, Clear.....	#11106*	\$559.95/set
8-pc. Set, Tinted.....	#11107*	\$759.95/set

4-DOOR HARDTOP SETS FOR 1957'S

7-pc. Set, Clear.....	#11104A	\$459.95/set
8-pc. Set, Tinted.....	#11105A	\$659.95/set
7-pc. Set, Clear.....	#11106A	\$559.95/set
8-pc. Set, Tinted.....	#11107A	\$759.95/set

FOR SMOKED GLASS ORDERS, ADD AN "S" TO THE TINTED PART NUMBER FOR YOUR APPLICATION. SMOKED GLASS NOT AVAILABLE WITH DATE CODE.



NOMAD GLASS SETS FOR 1955-57'S 

- 4-pc. Door/Vent Set, Assembled, Clear
..... #15289 \$496.00/set
- 4-pc. Door/Vent Set, Assembled, Tinted
..... #15290 \$496.00/set
- 4-pc. Door/Vent Set, Assembled, Smoked
..... #15291 \$496.00/set
- 6-pc. Side Set, Clear..... #11080 \$219.95/set
- 6-pc. Side Set, Tinted #11081 \$219.95/set
- 6-pc. Side Set, Clear..... #11082* \$289.95/set
- 6-pc. Side Set, Tinted #11083* \$289.95/set
- 8-pc. Side Set, Clear..... #11084 \$729.95/set
- 8-pc. Side Set, Tinted #11085 \$729.95/set
- 8-pc. Side Set, Clear..... #11086* \$1095.00/set
- 8-pc. Side Set, Tinted #11087* \$1095.00/set

NOMAD GLASS SETS FOR 1955-56'S 

- 10-pc. Set, Clear #11088 \$1295.95/set
- 10-pc. Set, Tinted #11089 \$1295.95/set
- 10-pc. Set, Clear #11090* \$1395.95/set
- 10-pc. Set, Tinted #11091* \$1395.95/set

NOMAD GLASS SETS FOR 1957'S 

- 10-pc. Set, Clear #11088A..\$1295.95/set
- 10-pc. Set, Tinted #11089A...\$1295.95/set
- 10-pc. Set, Clear #11090A* ..\$1395.95/set
- 10-pc. Set, Tinted #11091A* ..\$1395.95/set

2-DOOR SEDAN GLASS SETS FOR 55-57'S 

- 6-pc. Side Set, Clear..... #11092 \$219.95/set
- 6-pc. Side Set, Tinted #11093 \$219.95/set
- 6-pc. Side Set, Clear..... #11094* \$299.95/set
- 6-pc. Side Set, Tinted #11095* \$299.95/set
- 6-pc. Side Set, Assembled, Clear..... #15283 \$479.95/set
- 6-pc. Side Set, Assembled, Tinted
..... #15284 \$479.95/set
- 6-pc. Side Set, Assembled, Smoked
..... #15285 \$479.95/set

2-DOOR SEDAN SETS FOR 1955-56'S 

- 8-pc. Set, Clear #11096 \$649.95/set
- 8-pc. Set, Tinted #11097 \$649.95/set
- 8-pc. Set, Clear #11098* \$799.95/set
- 8-pc. Set, Tinted #11099* \$799.95/set

2-DOOR SEDAN GLASS SETS 1957'S 

- 8-pc. Set, Clear #11096A \$649.95/set
- 8-pc. Set, Tinted #11097A \$649.95/set
- 8-pc. Set, Clear #11098A \$799.95/set
- 8-pc. Set, Tinted #11099A \$799.95/set

4-DOOR SEDAN GLASS SETS FOR 55-57'S 

- 8-pc. Side Set, Clear..... #11108 \$281.95/set
- 8-pc. Side Set, Tinted #11109 \$281.95/set
- 8-pc. Side Set, Clear..... #11110* \$695.00/set
- 8-pc. Side Set, Tinted #11111* \$695.00/set
- 6-pc. Side Set, Assembled, Clear
..... #15286 \$479.95/set
- 6-pc. Side Set, Assembled, Tinted
..... #15287 \$479.95/set
- 6-pc. Side Set, Assembled, Smoked
..... #15288 \$479.95/set

4-DOOR SEDAN GLASS 1955-56'S 

- 10-pc. Set, Clear #11112 \$749.95/set
- 10-pc. Set, Tinted #11113 \$749.95/set
- 10-pc. Set, Clear #11114* \$899.95/set
- 10-pc. Set, Tinted #11115* \$899.95/set

4-DOOR SEDAN GLASS FOR 1957'S 

- 10-pc. Set, Clear #11112A \$749.95/set
- 10-pc. Set, Tinted #11113A \$749.95/set
- 10-pc. Set, Clear #11114A \$899.95/set
- 10-pc. Set, Tinted #11115A \$899.95/set

SEDAN AND WAGON DOOR GLASS WITH VENT DELETE

We now offer glass for those who have removed their vent windows. Please specify bodystyle when ordering.

- 1955-57 Clear..... #17177 \$83.95/ea.
- 1955-57 Tinted #17178 \$83.95/ea.
- 1955-57 Smoked..... #17179 \$83.95/ea.

FOR SMOKED GLASS ORDERS, ADD AN "S" TO THE TINTED PART NUMBER FOR YOUR APPLICATION. SMOKED GLASS NOT AVAILABLE WITH DATE CODE.

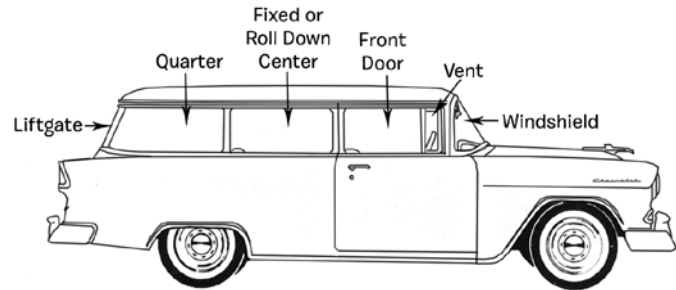
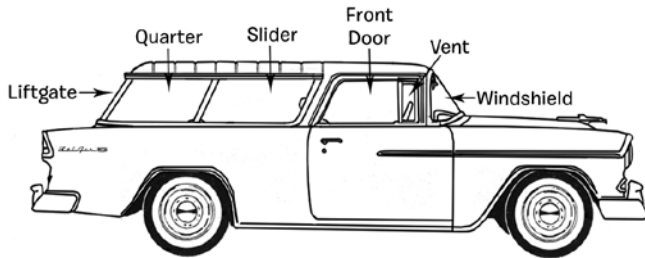
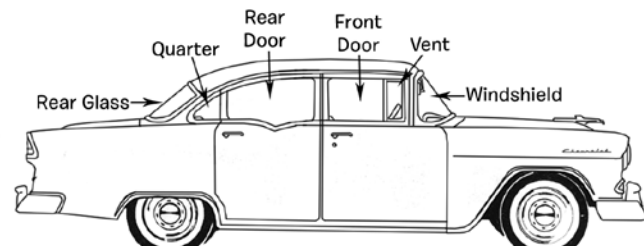
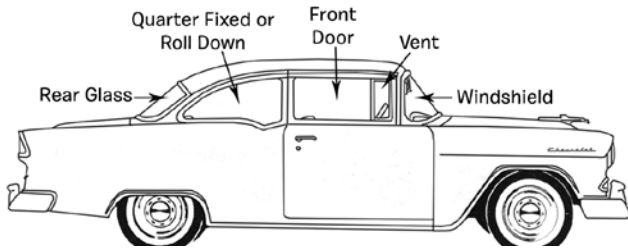

150 WAGON GLASS SETS

The center glass window on 150 wagons is either a stationary glass piece or one that rolls down. Please specify which type you need when placing your order.

150 2-DOOR WAGON SETS FOR 1955-57'S ^{Q/S}

6-pc. Side Set, Clear.....	#11116.....	\$219.95/set
6-pc. Side Set, Tinted.....	#11117.....	\$219.95/set
6-pc. Side Set, Clear.....	#11118*.....	\$525.00/set
6-pc. Side Set, Tinted.....	#11119*.....	\$525.00/set
8-pc. Side Set, Clear.....	#11124.....	\$729.95/set
8-pc. Side Set, Tinted.....	#11125.....	\$729.95/set
8-pc. Side Set, Clear.....	#11126*.....	\$1100.00/set
8-pc. Side Set, Tinted.....	#11127*.....	\$1100.00/set

150 2-DOOR WAGON GLASS 1955-56'S ^{1/2}

10-pc. Set, Clear.....	#11132.....	\$1159.95/set
10-pc. Set, Tinted.....	#11133.....	\$1159.95/set
10-pc. Set, Clear.....	#11134*.....	\$1395.95/set
10-pc. Set, Tinted.....	#11135*.....	\$1395.95/set

150 2-DOOR WAGON GLASS FOR 1957'S ^{1/2}

10-pc. Set, Clear.....	#11132A.....	\$1159.95/set
10-pc. Set, Tinted.....	#11133A.....	\$1159.95/set
10-pc. Set, Clear.....	#11134A.....	\$1395.95/set
10-pc. Set, Tinted.....	#11135A.....	\$1395.95/set

SEDAN DELIVERY GLASS FOR 1955-57'S ^{Q/S}

4-pc. Side Set, Clear.....	#11152.....	\$154.95/set
4-pc. Side Set, Tinted.....	#11153.....	\$154.95/set
4-pc. Side Set, Clear.....	#11154*.....	\$340.00/set
4-pc. Side Set, Tinted.....	#11155*.....	\$340.00/set

SEDAN DELIVERY GLASS 1955-56'S ^{1/2}

6-pc. Set, Clear.....	#11156.....	\$599.95/set
6-pc. Set, Tinted.....	#11157.....	\$599.95/set
6-pc. Set, Clear.....	#11158*.....	\$774.95/set
6-pc. Set, Tinted.....	#11159*.....	\$774.95/set

SEDAN DELIVERY GLASS FOR 1957'S ^{1/2}

6-pc. Set, Clear.....	#11156A.....	\$599.95/set
6-pc. Set, Tinted.....	#11157A.....	\$599.95/set
6-pc. Set, Clear.....	#11158A.....	\$774.95/set
6-pc. Set, Tinted.....	#11159A.....	\$774.95/set

210 2-DOOR WAGON GLASS FOR 55-57'S ^{Q/S}

6-pc. Side Set, Clear.....	#11120.....	\$219.95/set
6-pc. Side Set, Tinted.....	#11121.....	\$219.95/set
6-pc. Side Set, Clear.....	#11122*.....	\$525.00/set
6-pc. Side Set, Tinted.....	#11123*.....	\$525.00/set
8-pc. Side Set, Clear.....	#11128.....	\$729.95/set
8-pc. Side Set, Tinted.....	#11129.....	\$729.95/set
8-pc. Side Set, Clear.....	#11130*.....	\$1100.00/set
8-pc. Side Set, Tinted.....	#11131*.....	\$1100.00/set

210 2-DOOR WAGON GLASS 1955-56'S ^{1/2}

10-pc. Set, Clear.....	#11136.....	\$1159.95/set
10-pc. Set, Tinted.....	#11137.....	\$1159.95/set
10-pc. Set, Clear.....	#11138*.....	\$1259.95/set
10-pc. Set, Tinted.....	#11139*.....	\$1259.95/set

210 2-DOOR WAGON GLASS 1957'S ^{1/2}

10-pc. Set, Clear.....	#11136A.....	\$1159.95/set
10-pc. Set, Tinted.....	#11137A.....	\$1159.95/set
10-pc. Set, Clear.....	#11138A.....	\$1259.95/set
10-pc. Set, Tinted.....	#11139A.....	\$1259.95/set

4-DOOR WAGON GLASS FOR 1955-57'S ^{Q/S}

6-pc. Side Set, Clear.....	#11140.....	\$219.95/set
6-pc. Side Set, Tinted.....	#11141.....	\$219.95/set
6-pc. Side Set, Clear.....	#11142*.....	\$525.00/set
6-pc. Side Set, Tinted.....	#11143*.....	\$525.00/set
8-pc. Side Set, Clear.....	#11144.....	\$729.95/set
8-pc. Side Set, Tinted.....	#11145.....	\$729.95/set
8-pc. Side Set, Clear.....	#11146*.....	\$1100.00/set
8-pc. Side Set, Tinted.....	#11147*.....	\$1100.00/set

4-DOOR WAGON GLASS 1955-56'S ^{1/2}

10-pc. Set, Clear.....	#11148.....	\$1295.95/set
10-pc. Set, Tinted.....	#11149.....	\$1295.95/set
10-pc. Set, Clear.....	#11150*.....	\$1395.95/set
10-pc. Set, Tinted.....	#11151*.....	\$1395.95/set

4-DOOR WAGON GLASS FOR 1957'S ^{1/2}

10-pc. Set, Clear.....	#11148A.....	\$1295.95/set
10-pc. Set, Tinted.....	#11149A.....	\$1295.95/set
10-pc. Set, Clear.....	#11150A.....	\$1395.95/set
10-pc. Set, Tinted.....	#11151A.....	\$1395.95/set

FOR SMOKED GLASS ORDERS, ADD AN "S" TO THE TINTED PART NUMBER FOR YOUR APPLICATION. SMOKED GLASS NOT AVAILABLE WITH DATE CODE.