

DanChuk MFG.

1955-56-57 CHEVROLET RESTORATION PARTS

Proudly Made in the U.S.A.!



SANTA ANA, CALIFORNIA



BUY AMERICAN!
BUY DANCHUK!

10+ REASONS WHY DANCHUK IS YOUR TRI-FIVE ONE STOP SHOP

1. BEST QUALITY
2. PARTS MADE IN THE USA
3. LOW PRICE GUARANTEE
4. 40+ YEARS EXPERIENCE
5. 700+ PAGE CATALOG
6. FASTEST SHIPPING
7. BEST MOBILE APP
8. 5-6-7 TECH EXPERTS
9. 100'S OF DEALERS
10. 1000'S OF AFTERMARKET

+ BEST TRI-FIVE CAR SHOW IN THE COUNTRY!



DANCHUK 2.0

The Danchuk App is now available and packed with all the latest news and information any Tri-Five enthusiast could want!!

Catalog Available on your Mobile Device!



AT YOUR FINGERTIPS:

- SCROLL THROUGH CATALOG
- APP EXCLUSIVE SPECIALS
- LATEST DANCHUK NEWS
- TRI-FIVE NATIONALS NEWS
- SHOW & EVENT SCHEDULE
- ORDER PARTS IN JUST A COUPLE CLICKS
- VIEW DANCHUK VIDEOS, SALE ITEMS AND SOCIAL MEDIA WITH JUST A CLICK

Available for Mobile Devices:





TABLE OF CONTENTS

For over 44 years now, Danchuk has offered the very best to our customers; quality parts **Made in the USA** and helpful, knowledgeable customer service. Our 37th catalog features thousands of reproduction and aftermarket parts and accessories for 1955, 1956 and 1957 Chevrolets, so there's no need to look elsewhere. We're your one stop shop. As you've come to expect, we've included page after page of technical information, detailed photographs and illustrations to assist you in your car restoration projects. This is more than a catalog; it's a handy reference manual that we hope you'll enjoy using.

We would like to thank the management of General Motors Chevrolet Division for their continuing friendship and support.

This catalog was designed and produced in-house by Danchuk Mfg., Inc. No part of this catalog may be reprinted, reproduced or utilized in any form without the express written permission of Danchuk® Mfg., Inc.

© 2020 Danchuk Manufacturing, Inc.
All Rights Reserved
Printed in the USA

EXTERIOR TRIM AND HARDWARE	17-60	1
LENS SETS AND LIGHT ASSEMBLIES	61-84	2
INTERIOR TRIM AND UPHOLSTERY	85-232	3
ELECTRICAL AND AUDIO EQUIPMENT	233-260	4
SWITCHES AND IGNITION SYSTEMS	261-276	5
UNDER THE HOOD	277-302	6
FUEL AND EXHAUST	303-360	7
HEATING AND COOLING COMPONENTS	361-390	8
STEERING AND SUSPENSION	391-446	9
BRAKES AND WHEEL ASSEMBLIES	447-484	10
ENGINE & TRANSMISSION.....	485-532	11
SHEET METAL AND BODY PANELS	533-606	12
DOOR AND WINDOW HARDWARE AND SEALS	607-658	13
LITERATURE AND PRINTED MATTER.....	659-672	14
CAR CARE	673-694	15
GIFTS, NOVELTIES AND APPAREL	695-708	16
ORIGINAL SPECIFICATIONS	709-722	17
ORDERING AND SHIPPING INFORMATION.....	723-727	18
PARTS INDEX.....	728-752	19



**WORLD'S LARGEST MANUFACTURER OF
1955-56-57 CHEVROLET RESTORATION PARTS**

WWW.DANCHUK.COM

There's No Comparison **TO 1955-56-57 CHEVROLET**



Chevrolets have been a part of Danny and Art Danchuk's life since the 1950's. Both boys, Danny and Art, followed their father's footsteps into the tool and die business, as well as acquiring his appreciation for Chevy's. In 1956, when this photo was taken, they had no idea that 60 years later they would still be reaping the benefits from the skills and hard work that he instilled into them.

The Danchuks' love of auto restoration prompted an entry into the world of Chevy reproduction parts in 1976. The initial response was so overwhelming, they directed all their energy into manufacturing only '55, '56 and '57 Chevy parts, and have been going strong ever since. Danchuk is now the world's largest manufacturer of 1955-56-57 Chevrolet restoration parts. We achieved this title by bringing you parts that are superior to both the originals and all other reproductions on the market today. We take pride in producing parts that look better, fit better, last longer, are made in the United States of America and, of course, are competitively priced.

DANCHUK *Tri-Five Nationals*



In August of 2020 we will sponsor the 6th Annual Danchuk Tri-Five Nationals at Beech Bend Raceway in Bowling Green, Kentucky. Every year has been bigger and better than the previous year with more than 2,000 cars (Tri-Fives only) congregating upon Beech Bend for 3 days of all things Tri-Five

... car show, swap meet, drag racing, vendors and, of course, a chance to win the Golden Start Giveaway Tri-Five

car. We sincerely hope every 5-6-7 owner has a chance to make this event at least once. We are so proud and excited to be part of such a great event, and are truly grateful for all that make the trek to Kentucky!!

If you can't make it to the South, make sure to visit us if you are ever in the Southern California area. We have a large showroom where we display our reproduction parts and 57 cut-way car in a nostalgic setting. Plus, a second showroom where we house our fully restored Chevy Bel Airs. We have 1955 and 1956 convertibles, a 1956 Hardtop, a 1957 Nomad and the 1957 Tom "The Mongoose" McEwen Funny Car on display along with other collectibles from the Danchuk Collection. Also on display is a 1957 Chevy Bel Air which has cut-away body panels, parts, and all mechanical components so that you can visually inspect the inner workings of this American classic.



**CHECK US OUT ONLINE
WEBSITE: ORDER PARTS,
INSTRUCTION SHEETS,
INSTALLATION ARTICLES,
DIGITAL CATALOG & MORE!
YOUTUBE: HOW-TO VIDEOS
& MORE**

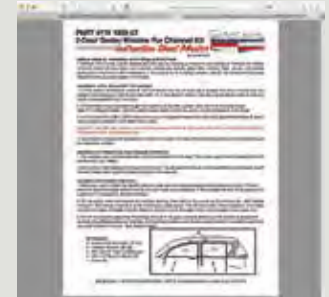

RESTORATION PARTS MANUFACTURED *in the U.S.A.!!*



**DANCHUK IS MOBILE:
DANCHUK.COM: MOBILE FRIENDLY
FACEBOOK, INSTAGRAM, TWITTER:
DAILY POSTS AND CUSTOMER CARS
DANCHUK APP: CATALOG
@ YOUR FINGERTIPS**



Our customer service representatives receive hundreds of phone calls per day. Not only do they take phone orders, they also offer friendly and knowledgeable technical advice as well as serve our walk-in customers.

The heart of Danchuk is the manufacturing department. Only after much research and documentation are complete is production begun by our knowledgeable production staff. With such a diverse inventory of products being produced, extensive knowledge of

manufacturing processes is a must. Technology has changed so much over the past 49 years. We have been able to take advantage of some advances in manufacturing, but realize some tried and true methods are still the best way to manufacture certain parts. Combining older and newer manufacturing techniques gives us the best of both worlds.

This latest catalog is no exception to our philosophy of constant improvement. Besides all the key original parts Danchuk manufactures and sells, we also retail thousands of aftermarket items from the biggest names in the restoration industry. Not only can you restore a 5-6-7 to its original glory, but at Danchuk you can customize your classic to your heart's desire. Make Danchuk your one-stop shop for all your 5-6-7 Chevy wants and needs.





Danchuk

MANUFACTURING 1976

There's one word that truly separates us from the rest – manufacturing. Without our manufacturing department, we'd be just another distributor. Over the last four decades, starting with the Danchuk brothers and their dad, Danchuk Manufacturing has perfected the art of tool, die and 1955-56-57 parts manufacturing.

THE DESIGN

The design process is as important as any other step. If the design is off, the tooling and part will surely not be right. We start with a perfect fitted and tested original part and from there we start down the long road to the manufacturing of the tooling. Whether we are making a complex multiple step stamping die tool like the '55 & '56 grills or cutting a precision cavity in a piece of solid steel to produce a Class-A injection mold to make parts like the '57 grille bar, we start the process the same. Once we are sure we have a perfect original, we reverse engineer the part using various measuring systems. The measurements are then transformed into a three dimension model using the latest CAD software. We then use this model to design the tooling that will reproduce the original part.

TOOLING

Our tooling facility combines the technology of brand new state of the art machinery and classic old school set-ups. When duplicating a 60 year old part, many times the absolute best way to make a tool is with vintage technology. By combining modern CNC's with manual mills, lathes, grinders and a whole assortment of other machines and tools we can achieve the end result in our tooling that will allow us to manufacture the best quality American made parts possible.

MATERIALS

Once the tooling is finished, but before the manufacturing can begin, we start with the best materials available. We use only top quality steel, virgin zinc for our castings, virgin plastic for our lenses and the best rubber compounds there are. It is because of our high standards for materials that all of our parts are of a superior quality. It is impossible to achieve consistent quality in plating with inferior metals or expect longevity in quality with cheap plastics or rubber.

MANUFACTURING

If you think the design and tooling is complex, time consuming and intricate, you should follow the birth of a part through the manufacturing process. Just like tooling, we believe the best way to control and achieve the quality that our customers have come to expect is by keeping as much of the manufacturing in-house as possible. That is why our manufacturing facility includes machinery like 300 ton stamping presses, plastic injection machines, stud welders, a paint booth and all the basics like mills, lathes, drill presses and the like. Manufacturing is the largest department in the company and uses over 16,000 square feet of our 86,000 square foot facility to function efficiently.

QUALITY CONTROL

Once the parts are done in manufacturing, we move them on to our highly trained quality control department where they are tested and inspected for perfection in both fit and appearance. We take the inspection of our parts very seriously and we think it shows in the end products.

MADE IN THE USA

We think these American classics deserve American-made reproduction parts. We are proud to offer parts that are made in our Santa Ana, California facility by employees that appreciate the beauty of these cars and all the parts that make them classic.

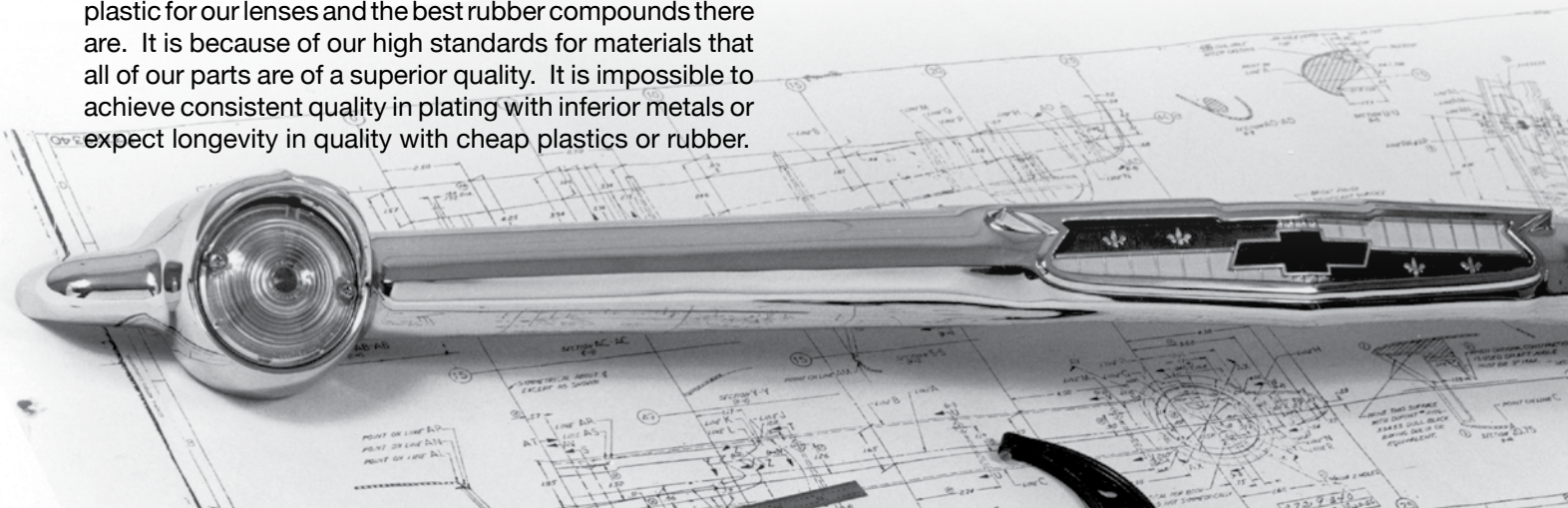



Danchuk

MANUFACTURING 2020

A lot has changed in 40+ years of manufacturing, but the dedication to making the best Tri-Five Chevrolet parts hasn't wavered. Our commitment to manufacture the best quality parts at a competitive price, we believe is the reason we're still standing after 40 years.

OUR GROWTH

The popularity of the hot rodding industry, TV shows that promote the hobby, trade shows like SEMA and of course the absolute genius of the 1955-56-57 Chevy design have all helped to make these classics even more popular than they were 40 years ago. These things have made the value of Tri-Fives skyrocket which has helped support our growth even through the toughest of economies. The need for quality parts has allowed us to continue the research and development of much needed, hard to find parts.

OUR SELECTION

The number of different parts we manufacture today is more than we could have ever imagined. As the years go by, we become more aware of the parts that are in need and we continue to add to our ever-growing list. After 40 years in business we are proud to say we are hands-down the "World's Largest Manufacturer of 1955-56-57 Chevrolet Restoration Parts" by offering more than 1,000 different reproduction parts specifically for 1955-56-57 Chevrolets.

OUR QUALITY

In an ever changing world, where some companies are looking for ways to make their products for less, Danchuk is proud to say that our quality has only gotten better over the years. As we've fine tuned tooling, become more proficient in manufacturing and with the idea that "practice makes perfect", we are confident our quality is better now than years ago.

OUR METHODS

Technology has changed so much over the past 40 years. We have been able to take advantage of some advances in manufacturing, but realize some tried and true methods are still the best way to manufacture certain parts. Combining older and newer manufacturing techniques gives us the best of both worlds.

OUR COMMITMENT

We want every part that ships from Danchuk Manufacturing to completely satisfy our customer and/or dealers - our reputation depends on it. If a part is not absolutely flawless, then we will consider it a second. At our Annual Seconds Sale, these parts are offered at drastically reduced prices, many times with flaws that are barely noticeable. And we will gladly price match. Anytime an exact part is offered in print or online for less somewhere other than Danchuk, just bring it to our attention and we will gladly match the price.

OUR GRATITUDE

We would like to thank all of our customers for their continued support, inspiration and input. It is through your needs and suggestions that we decide which project to take on next, so please continue.



Danchuk 2020 SHOW SCHEDULE

PLEASE CHECK [HTTPS://DANCHUKUSA.COM/SHOWS](https://danchukusa.com/shows) REGULARLY FOR SHOW UPDATES

START DATE	SHOW NAME	LOCATION	CITY, STATE
1/18	NASHVILLE AUTO FEST	THE FAIRGROUNDS NASHVILLE	NASHVILLE, TN
1/24	GRAND NATIONAL ROADSTER SHOW	FAIRPLEX POMONA	POMONA, CA
2/2	STONES RIVER REGION AACA SWAP MEET	THE FAIRGROUNDS NASHVILLE	NASHVILLE, TN
2/7	SPRING MOULTRIE SWAP MEET	SPENCE FIELD	MOULTRIE, GA
2/21	WINTER AUTOFEST LAKELAND	SUN 'N FUN EXPO CAMPUS	LAKELAND, FL
2/29	KYANA SWAP MEET	KENTUCKY EXPOSITION CENTER	LOUISVILLE, KY
3/7	DAVE & ED'S PRO-FORMANCE MEET	STARK COUNTY FAIRGROUNDS	CANTON, OH
3/8	ROCKY MANGINELLI MENELLI MEMORIAL SWAP MEET	LANCASTER EVENT CENTER	LINCOLN, NE
3/4	EMERALD COAST CRUIZIN' CAR SHOW	AARON BESSANT PARK	PANAMA CITY BEACH, FL
3/19	RUN TO THE SUN CAR SHOW	FORMER MYRTLE SQUARE MALL	MYRTLE BEACH, SC
3/27	SPRING TURKEY RUN	DAYTONA INTERNATIONAL SPEEDWAY	DAYTONA, FL
4/2	SPRING CHARLOTTE AUTOFAIR	CHARLOTTE MOTOR SPEEDWAY	CHARLOTTE, NC
4/3	DEL MAR NATIONALS	DEL MAR FAIRGROUNDS	DEL MAR, CA
4/19	ORANGE PLAZA CAR SHOW	DOWNTOWN ORANGE	ORANGE, CA
4/16	SPRING PIGEON ROD RUN	LECONTE EVENT CENTER	PIGEON FORGE, TN
4/22	SPRING CARLISLE SWAP MEET	CARLISLE FAIRGROUNDS	CARLISLE, PA
4/24	SPRING JEFFERSON SWAP MEET & CAR SHOW	JEFFERSON COUNTY FAIRGROUNDS	JEFFERSON, WI
4/25	ATLANTA MOTORAMA	ATLANTA MOTOR SPEEDWAY	HAMPTON, GA
5/1	DAVE & ED'S CANFIELD MEET	CANFIELD FAIRGROUNDS	CANFIELD, OH
5/1	AMERICAN TRI-FIVE ASSOCIATION'S WESTERN INVASION PRESENTED BY DANCHUK	FAMOSO RACEWAY	BAKERSFIELD, CA
5/3	CLASSIC CHEVYS OF SO. CALIFORNIA CAR SHOW	RANCHO SAN ANTONIO	CHATSWORTH, CA
5/15	CHEVY CLASSIC ROUND UP (TRI-FIVE SHOW)	THE INN AT CHRISTMAS PLACE	PIGEON FORGE, TN
5/22	SPRING SPRINGFIELD SWAP MEET	CLARK COUNTY FAIRGROUNDS	SPRINGFIELD, OH
6/7	RANDOLPH SPRING SUPER BONANZA	RANDOLPH FAIRGROUNDS	RANDOLPH, OH
6/12	WHEELS ON THE HILL	NOCCALULA FALLS PARK	GADSDEN, AL
6/14	PEOTONE TRI CHEVY SWAP MEET	WILL COUNTY FAIRGROUNDS	PEOTONE, IL



Danchuk is looking forward to a year filled with good shows and lots of Tri-Fives. Either Danchuk or one of our Authorized Dealers will be at the following shows in 2020 to give away goodies, talk Tri-Fives, sell parts and have a good time! This list will grow, and sometimes details change, so please check our website regularly. Website will list Corporate, Authorized Dealer, and Sponsored shows, with attending Authorized Dealers listed. Many shows are 2+ days.

START DATE	SHOW NAME	LOCATION	CITY, STATE
6/19	BIG BUTLER PARTS A RAMA	BIG BUTLER FAIRGROUNDS	PROSPECT, PA
6/19	BACK TO THE 50'S	MINNESOTA STATE FAIRGROUNDS	SAINT PAUL, MN
6/26	CARLISLE CHEVROLET NATIONALS	CARLISLE FAIRGROUNDS	CARLISLE, PA
6/27	RICK'S CLASSIC CHEVY PART'S TRI-FIVE GATHERING	DOWNTOWN SOMERSET	SOMERSET, KY
7/2	VÄSTERÅS SUMMER MEET	JOHANNISBERGS AIRFIELD	VÄSTERÅS, SWEDEN
7/3	HEARTLAND NATIONALS	IOWA STATE FAIRGROUNDS	DES MOINES, IA
7/9	IOLA CAR SHOW AND SWAP MEET	IOLA SHOW GROUNDS	IOLA, WI
7/10	PPG NATIONALS	OHIO EXPO CENTER	COLUMBUS, OH
7/17	DAVE & ED'S CANFIELD MEET	CANFIELD FAIRGROUNDS	CANFIELD, OH
7/17	SYRACUSE NATIONALS	NEW YORK STATE FAIRGROUNDS	SYRACUSE, NY
7/24	PACIFIC NORTHWEST NATIONALS	WASHINGTON STATE FAIR EVENTS CENTER	PUYALLUP, WA
8/1	SUMMER ELKHORN SWAP MEET & CAR SHOW	WALSWORTH COUNTY FAIRGROUNDS	ELKHORN, WI
8/5	HOT AUGUST NIGHTS	RENO EVENTS CENTER	RENO, NV
8/6	STREET ROD NATIONALS SWAP MEET	KENTUCKY EXPOSITION CENTER	LOUISVILLE, KY
8/13	DANCHUK TRI-FIVE NATIONALS	BEECH BEND PARK	BOWLING GREEN, KY
8/28	FROG FOLLIES ROD RUN	VANDEBURGH COUNTY 4-H CENTER	EVANSVILLE, IN
9/4	FALL SPRINGFIELD SWAP MEET	CLARK COUNTY FAIRGROUNDS	SPRINGFIELD, OH
9/11	SHADES OF THE PAST	DOLLYWOOD'S SPLASH COUNTRY	PIGEON FORGE, TN
9/17	FALL PIGEON ROD RUN	LECONTE EVENT CENTER	PIGEON FORGE, TN
9/18	DAVE & ED'S CANFIELD MEET	CANFIELD FAIRGROUNDS	CANFIELD, OH
9/20	BELOIT AUTORAMA	PRESERVATION PARK	BELOIT, WI
9/25	FALL JEFFERSON SWAP MEET & CAR SHOW	JEFFERSON COUNTY FAIRGROUNDS	JEFFERSON, WI
9/25	LONE STAR NATIONALS	TEXAS MOTOR SPEEDWAY	FORT WORTH, TX
9/26	CRUISIN FOR THE CURE	OC FAIR & EVENT CENTER	COSTA MESA, CA
9/27	PICNIC BY THE BAY	EMBARCADERO MARINE PARK NORTH	SAN DIEGO, CA
9/30	FALL CARLISLE SWAP MEET	CARLISLE FAIRGROUNDS	CARLISLE, PA
10/4	CRUISIN THE COAST	MISSISSIPPI COAST COLISEUM	BILOXI, MS
10/9	MURIETTA ROD RUN	OLD TOWN MURIETTA	MURIETTA, CA
10/15	FALL CHARLOTTE AUTOFAIR	CHARLOTTE MOTOR SPEEDWAY	CHARLOTTE, NC
10/19	LOUISVILLE FALL SWAP MEET	KENTUCKY EXPOSITION CENTER	LOUISVILLE, KY
10/20	CEDAR RAPIDS REGION AACA FALL SWAP MEET	HAWKEYE DOWNS SPEEDWAY & EXPO	CEDAR RAPIDS, IA
11/3	SEMA	LAS VEGAS CONVENTION CENTER	LAS VEGAS, NV
11/7	DAVE & ED'S PRO-FORMANCE MEET	STARK COUNTY FAIRGROUNDS	CANTON, OH
11/20	FALL MOULTRIE SWAP MEET	SPENCE FIELD	MOULTRIE, GA
11/26	DAYTONA TURKEY RUN	DAYTONA INTERNATIONAL SPEEDWAY	DAYTONA, FL

Hope to see you at a show!

New and Improved

1955 GRILLE PART #478

IS A PERFECT EXAMPLE OF DANCHUK'S COMMITMENT TO QUALITY



DANCHUK HAS USED THE SLOGAN "THERE IS NO COMPARISON" FOR YEARS AND THE '55 GRILLE IS A PERFECT EXAMPLE OF JUST THAT . . . ZERO COMPARISON TO THIS PIECE OF TRI-FIVE ARTWORK.

When it came time to retool the iconic '55 Chevy grille, we knew we'd have to start clean to insure that not only would we be making the best fitting and looking '55 grilles ever produced, but to also be able to mass-produce this signature piece for years to come. So our original tooling was scrapped and we committed to starting over. The process of designing a tool from scratch is always, without question, a daunting task. But Danchuk would rather take the time to make it right than make an inferior part just to be the first.

The year-plus long process of trial and error, back and forth, editing drawings, fitting prototypes until every detail was perfected, get the plating dialed-in and consistent, getting every production hiccup ironed out was all challenging. But the end results speak for themselves and we couldn't be more excited. If we do say so ourselves, the fit is amazing and the finish is without a doubt the best there has ever been. Every detail has been addressed. The main frame is virtually immaculate with no waviness or tooling marks (scratches) that are common on originals or other reproductions. These are plated with the best USA plating available and the finished product is simply a work of art without compromise. There is even whispers of "too perfect" in judging circles.

When you receive your new Danchuk '55 grille, be sure to take a good look at it. We hope that you agree that this grille is simply the best grille ever produced for the '55 Chevy. And we hope that you continue to ask for, or perhaps demand, **Made in the USA** parts for your American Classic!!



Behind the scenes tooling photos and '55 enthusiasts giving the new grille a thorough look over at the 2019 Danchuk Tri-Five Nationals. Nothing but positive feedback since it's debut.

DANCHUK SPONSORS JEFF LUTZ OF **STREET OUTLAWS**

We first became aware of Jeff, owner of Lutz Race Cars in Callery, Pennsylvania, when we started seeing YouTube videos of a wicked black 1957 Chevy pulling insane numbers on the dyno and running down different tracks . . . just teasers for us. From then on we followed Jeff around the web. The first, yes first, of the '57's Jeff would build was called "The Beast". Built for the 2012 season "The Beast" sported a methanol burning 632 CI 2500 HP twin turbo charged BBC that became immensely popular with the folks that watched Street Outlaws (on Discovery) and wreaked havoc on all comers.

Jeff and his son, Jeff, Jr. followed that car up with an almost identical car they called "The Evil Twin". Same engine specs but now with a full weight saving fiberglass body with carbon fiber components and Optic Armour composite windows. The car weighed in at only 3100 pounds with Jeff in the driver seat, a full 800 lbs. less than "The Beast". "Evil Twin" regularly ran 6.70 times in the quarter and almost won the 2014 Drag Week event losing by a factor of less than 0.001 second.

At the Inaugural Danchuk Tri-Five Nationals in 2015, Jeff and his son drove the "Evil Twins" a number of times down the drag strip at Beech Bend Raceway to the delight of the crowd. If you are a Tri-Five fan you haven't lived until you have seen an almost identical pair of '57's blasting down the quarter mile. Truly a sight to see.

The third '57 that Jeff and the crew at Lutz Race Cars built, and the one he is campaigning now, debuted at the 3rd Annual Danchuk Tri-Five Nationals in 2017. Painted a stunning bright yellow and sporting a downsized 3500 HP BBC (only 540ci), again with twin turbos, the car took the show by storm with runs that he would not let us see numbers for. No doubt so he did not tip his hand as to how fast the new car was. Simply named "The '57" this new car has become probably the most photographed '57 Chevy in history. It was built to replace his '69 Pro Mod Camaro and we read that preliminary times put the car just a 10th of a second off the Camaro. In 2019, Danchuk helped Jeff Lutz rebuild "The '57" in just a few days after a wreck on the strip. See the full story on the Danchuk blog.

Impressive, and truly a force to be reckoned with. We can't wait to see how many times this car will be in the winner's circle during Drag Week and on Street Outlaws. Jeff also races many, many other places. So if you get a chance to see him run, make sure you go. You will not be disappointed.



In 2020, Danchuk will be helping Jeff Lutz rebuild the '57 known as "The Beast". Watch for the story on Discovery, at danchuk.com, and on Danchuk social media.



Join today to be a part of



1955-1956-1957 CHEVROLET ONLY FEATURES, TECH ARTICLES, EXPERT ADVICE, CLASSIFIED ADS, SHOWS, ROAD TRIPS & MORE



Become a member for just
\$45 a year!

americantrifive.com 855.567.1957

Membership Includes:

- NINE full color, Tri-Five only issues of the *American Tri-Five* magazine
- A special *View from the Road* coffee table annual book
- Discounts & Free Shipping
from Woody's, the Tri-Five Experts*
- Tri-Five ONLY road trips across the USA
- And more!

*Not available on all items/orders

*Staying True
to Tri-Fives*

THE SIXTH ANNUAL DANCHUK

Tri-Five Nationals

**JOIN US FOR THE LARGEST
TRI-FIVE GATHERING
IN THE WORLD!!!**

**CAR SHOW - DRAG RACING - SWAP MEET
1955-56-57 CHEVY ONLY VENDORS & MORE**



2020 GOLDEN STAR GIVEAWAY CAR

**AUGUST 13-14-15, 2020
BEECH BEND PARK
BOWLING GREEN, KENTUCKY**

Name _____

Address _____

City _____

St ____ Zip _____ Country _____

Email _____

Phone _____ ATFA # _____

CIRCLE Year: 55 56 57 Body:

SEDAN HARDTOP CONVERTIBLE WAGON
NOMAD DELIVERY TRUCK CORVETTE

CHECK ONE / OR MORE

\$45 MEMBERSHIP TO ATFA

WESTERN INVASTION - MAY 1-2, BAKERSFIELD

\$65 REGISTRATION *Western Invasion* (\$55 for members)

\$100 *Western Invasion* DRAG RACING

\$100 *Western Invasion* REGISTRATION & AMERICAN
TRI-FIVE ASSOCIATION MEMBERSHIP/RENEWAL

TRI-FIVE NATIONALS - AUG 13-15, KENTUCKY

\$65 REGISTRATION *Tri-Five Nationals* (\$55 for members)

\$100 *Tri-Five Nationals* DRAG RACING

\$100 *Tri-Five Nationals* REGISTRATION & AMERICAN
TRI-FIVE ASSOCIATION MEMBERSHIP/RENEWAL

METHOD OF PAYMENT: CHECK CREDIT CARD

CC# _____ EXP _____

Name on Card _____

Signature _____

**Send to American Tri-Five Association
23950 Salt Fork Road - Bright, IN 47025
Fax 812-637-2370**

**REGISTRATION CAN BE COMPLETE BY
PHONE, ONLINE, FAX OR MAIL.
REGISTRATION IS OPEN THROUGH NOON
ON SATURDAY OF THE SHOWS.**

Online Registration at americantrifive.com
or call 855.567.1957

AMERICAN TRI-FIVE ASSOCIATION'S

WESTERN INVASION

PRESENTED BY DANCHUK



**MAY 1-2, 2020
FAMOSO RACEWAY
BAKERSFIELD, CA**

**CAR SHOW - DRAG RACING - SWAP MEET
1955-56-57 CHEVY ONLY VENDORS & MORE**

Space Cleaner was originally tested and designed for the aerospace and aircraft world. It was tested on aircraft windshields and outer surfaces in all the harsh elements they encounter day after day.

During all our testing was when we discovered how well it worked for so many other applications. This product removes dirt, bugs and grime but leaves behind a protective microfilm to deflect the next assault of the atmosphere. Space Cleaner is an innovative new product designed to out perform any like cleaner on the market. It was used to safely and thoroughly clean and protect chrome, stainless, glass and plastic with great success and satisfaction. Before long people began testing it on their precious computer screens, cell phones, iPads and glass of all kinds, also with great success.

Space Cleaner is the child of that exceptional aircraft product altered to better enhance the ease of use, safety and versatile qualities the consumer so needed. Space Cleaner is an innovative new product designed to out perform any like cleaner on the market. We've kept the dust and dirt encapsulating qualities of the original aerospace product along with its unmatched ability to effortlessly remove smudges and fingerprints and leave a streak free beautiful clean while increasing the amount of all natural and safe clean enhancing ingredients for a much broader and all purpose use while maintaining the protective micro-film.

Whether you are a daily constant cleaner or a once a week tidy up the office person, Space Cleaner is the product for you!

CLEAN YOUR WORLD WITH



**FOR A CRYSTAL CLEAR CLEAN
MULTI-SURFACE
CLEANER/POLISH**

WORKS GREAT ON

- **GLASS**
- **PLASTIC**
- **SCREENS**
- **STAINLESS**
- **CELL PHONES**

AND SO MUCH MORE!

A special high lubricity formula that actually encapsulates dust particles. An innovative product that removes surface dust, fingerprints and smudges while leaving a clean, glossy finish. Easy to use, just spray on and wipe with microfiber cloth. On small electronic devices spray directly on cloth first, then wipe device.

- 1-Ounce #SC1001\$2.95**
- 2-Ounce #SC1002\$3.95**
- 4-Ounce #SC1004\$4.50**
- 8-Ounce #SC1008\$4.95**

SPACECLEANER.COM
or Call @ (800) 854-6911



DON'T TURN ANOTHER PAGE UNTIL YOU READ THIS!

MANUALS ARE A MUST WHEN RESTORING A CLASSIC

If you're even tinkering with a 1955, '56 or '57 Chevy, save yourself hours of frustration and headache by investing in a set of these invaluable manuals. We were amazed how much we learned, simply by opening one of these gems up and thumbing through each section. We've also realized most people don't take the time to read the instructions, whether you're putting together a bike, computer or a classic Chevy, until you're stuck. Make things easy on yourself by keeping a shop

and assembly manual within arms' reach for all those times when things just aren't making sense. These informative manuals come straight from GM, with every mechanical and maintenance detail covered, as well as all the illustrations you need to make heads from tails. Shop manuals are available for the 1955 and '57, with the '56 covered in a supplement that accompanies the '55 manual. Assembly manuals are available for each year, '55, '56 and '57 and contain detailed drawings and the

original part numbers essential for a correct restoration. The cost of these manuals is a fraction of what you can spend on a restoration and can save you days of frustration and labor. We figure anyone restoring a tri-five should undoubtedly have the appropriate manuals and a Danchuk catalog at their fingertips to make even the most complex job go smoothly. Think of these as "Tri-Five 101" required reading.

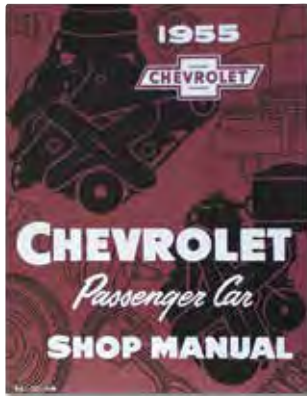

1955 CHEVROLET SHOP MANUAL

Contains over 500 pages devoted to the 1955 model year. This authorized reprint of a GM manual documents every mechanical operation involved in the care and maintenance of the 1955 Chevy. Used exclusively by mechanics in the Chevrolet garages since the car first hit the streets.

1955..... #522.....\$19.95/ea.



1956 SHOP MANUAL SUPPLEMENT

Supplement to the 1955 manual, this covers only the changes made for 1956. There is a section devoted exclusively to factory air conditioning. Both the 1955 and 1956 manuals are required for complete information. Authorized reprint of the GM original used exclusively by mechanics in the Chevrolet garages.

1956..... #523.....\$13.95/ea.



1957 CHEVROLET SHOP MANUAL

Filling over 700 pages with detailed information, this book is a must for 1957 owners. This comprehensive manual covers all engines, transmissions, and body styles for the 1957 model year. It's an authorized reprint of the GM original used exclusively by mechanics in Chevrolet dealerships and garages.

1957..... #524.....\$28.95/ea.



CHEVROLET FACTORY ASSEMBLY MANUALS

These bound books are reprints of the manuals used on the assembly line at General Motors and are essential for correct car restoration. Each manual contains detailed assembly drawings, original part numbers, and more. You can save yourself much time and frustration by understanding the complete assembly before you begin a project.

1955..... #506.....\$21.95/ea.
 1956..... #507.....\$21.95/ea.
 1957..... #508.....\$21.95/ea.

DANCHUK ICON LEGEND

PLEASE REVIEW WHAT EACH OF THESE ICONS MEAN IN CATALOG & WEBSITE
SOME CAN AFFECT SHIPPING COSTS



THIS ICON MEANS THAT TO THE BEST TO OUR KNOWLEDGE, THIS PART IS MADE IN THE USA. WE MAINLY USE THIS ICON TO INDICATE A PART MADE BY DANCHUK OR IN INSTANCES WHERE THERE ARE TWO VERSIONS AVAILABLE - AN AMERICAN MADE VERSION AND A IMPORTED OPTION. IF THE LISTING OFFERS BOTH, THE USA MADE VERSION IS OFTEN NOTED WITH AN ASTERISK.



THIS ICON MEANS A PART WILL INCUR AN EXTRA SHIPPING CHARGE. THIS ICON MEANS THAT THIS PART IS EITHER OVERSIZED AND/OR OVERWEIGHT AND COSTS MORE TO SHIP TO YOU. PARTS WITH THIS ICON DO NOT QUALIFY FOR ANY FREE SHIPPING PROMOTIONS.



THIS ICON MEANS THAT A PART IS MANUFACTURED BY GOLDEN STAR MANUFACTURING. GOLDEN STAR MANUFACTURING SUPPLIES A FOREIGN VERSION OF MANY SHEET METAL PARTS THAT MAY BE AVAILABLE IN AN AMERICAN MADE VERSION.



THIS ICON MEANS A PART WILL REQUIRE A TRUCK FREIGHT DELIVERY AND WILL INCUR AN EXTRA FREIGHT CHARGE. DELIVERIES REQUIRING A MOTORIZED LIFTGATE OR TO RURAL RESIDENTIAL AREAS CAN AFFECT COST. PLEASE CALL FOR A QUOTE. PARTS WITH THIS ICON DO NOT QUALIFY FOR ANY FREE SHIPPING PROMOTIONS.



THIS ICON MEANS A PARTS IS A LICENSED GM PART.



THIS ICON MEANS PER CALIFORNIA PROP 65, A PART(S) MAY CONTAIN CHEMICALS KNOWN TO THE STATE OF CALIFORNIA TO CAUSE CANCER AND/OR BIRTH DEFECTS OR REPRODUCTIVE HARM. www.p65warnings.ca.gov

BECOME AN AUTHORIZED DANCHUK DEALER!

The illustration shows a storefront for a Danchuk store. At the top, the word "Danchuk" is written in large, stylized, metallic letters. Below this, the store is divided into sections. On the left, there's a "CHEVROLET SALES * PARTS * SERVICE" sign. In the center, there's a "PARTS ACDelco" sign. On the right, there's a "Tires & Batteries SERVICE OIL CHANGE & LUBE" sign. A yellow box on the right side of the store contains text about becoming an authorized dealer.

Do you own a Tri-Five business? Would you like to start a Tri-Five business? Danchuk is not only the world's largest retailer of 5-6-7 parts, but we are also the largest wholesaler of Tri-Five parts. Contact us today if you would like more information about how you can become an Authorized Danchuk Dealer.

Call: (714)751-1957 Email: ROSCOE@DANCHUK.COM

1. Exterior

SECTION AT A GLANCE:

Emblems	18
Scripts.....	20
Grilles	24
Custom.....	26
Bars	28
Related	30
Hood Birds & Bars	32
Hood Rockets & Vees	34
Rocker Panels	35
1955 Side Mouldings	36
Accessory Trim	37
1956 Side Mouldings	38-39
1957 Side Mouldings	40-41
1957 Side Panel Inserts	42
Fin Mouldings	44
Door Belt Mouldings	45
Rear View Mirrors	46
Fender Trim	47
Bumpers & Related.....	48-54
Tailgate Trim	55
License Plate	56
Continental Kit.....	58
Moulding Clips	59-60



#371A



#371



#14070



#373A



#374A

HOOD AND TRUNK EMBLEMS WITH BEZELS

The best emblems on the market today with all the correct colors: true red, white and blue. Our (best) emblems are backpainted and then vacuum-metalized for that reflector-like look. Each emblem is mounted inside a beautiful chrome bezel, a perfect glove fit. These faithful reproductions are used on 1955 through 1958 models. Hardware included.

Made in the USA*

1955 Best, Hood.....	#371*	\$74.95/ea.
1955 Good, Hood.....	#16702.....	\$64.95/ea.
1955 Best, Trunk.....	#371A*.....	\$74.95/ea.
1955 Good, Trunk.....	#16703.....	\$64.95/ea.
1956-58 6 Cyl., '56 exc. Nomad, '57 exc. Bel Air, Trunk.....	#1492.....	\$114.95/ea.
1956 6 Cyl., Hood.....	#10230.....	\$129.95/ea.
1956 Best, Hood, V8, 7-1/2" Long.....	#373A*.....	\$62.95/ea.
1956 Good, Hood, V8, 7-1/2" Long.....	#16704.....	\$52.95/ea.
1956 Best, Trunk, V8, 7-1/2" Long.....	#374A*.....	\$62.95/ea.
1956 Good, Trunk, V8, 7-1/2" Long.....	#16705.....	\$52.95/ea.
1957 Trunk, Gold, Bel Air w/ 6 Cyl.....	#14070.....	\$119.95/ea.

Parts #371, #371A, #373A, #374A and #1492 shown above, contain trademarks of General Motors Corp. and are used by Danchuk Mfg., Inc. under license.



#377



#372



#374



#375

HOOD, TRUNK AND GRILLE BAR EMBLEMS

Danchuk's emblems are exact reproductions of the originals and are easily installed into your bezel or grille bar, depending on your application. One of our greatest concerns about reproducing emblems is that the colors stay true to the originals. These emblems are a fine example of that attention to detail. **Made in the USA.**

1955 Hood & Trunk, '56-58 6 Cyl., Trunk.....	#372.....	\$38.95/ea.
1956 6 Cyl., Hood	#375.....	\$46.50/ea.
1956 V8, Hood	#373.....	\$29.95/ea.
1956 V8, Trunk	#374.....	\$29.95/ea.
1957 Grille Bar (Use Installation Kit #376).....	#377.....	\$38.95/ea.

Parts #372, #373, #374 and #377, shown above, contain trademarks of General Motors Corp. and are used by Danchuk Mfg., Inc. under license.



#365



#365A

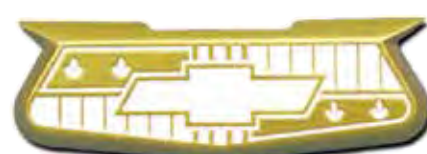

#2342

CREST EMBLEMS

These beautiful emblems are a true testament to American quality. All of our emblems are **Made in the USA.** #365, #V365, and #365A are all die-cast zinc and plated with the most beautiful gold or chrome finish that the USA has to offer. #2342 is a perfect reproduction of the original GM forged and anodized original. Hardware included.

1955-57 Best, Bel Air, Gold.....	#365.....	\$52.95/pr.
1955-57 Good, Bel Air, Gold.....	#V365.....	\$52.95/pr.
1955-57 Best, Custom, Chrome	#365A.....	\$52.95/pr.
1957 Bel Air, Show Quality.....	#2342.....	\$75.95/pr.



#541



#541A

SCRIPTS

1957 "CHEVROLET" SCRIPTS



Choosing the right 1957 Chevrolet script for your car is determined by two factors- the model or body style and the engine type. Scripts are either gold or chrome, and either 13-inch or 15-inch long. The Bel-Air model originally used gold emblems, while the 150 and 210 models used chrome. V8 engines require a 13-inch script that is mounted above the hood and/or trunk vee; 6-cylinder engines require a 15-inch script that is mounted on the hood. Please see table below to determine which script(s) you will need. **Proudly Made in the USA by Danchuk!**

- 1957 Bel Air V8, Gold, 13"..... #541..... \$34.95/ea.
- 1957 Bel Air V8, Gold, 13"..... #V541..... \$34.95/ea.
- 1957 Bel Air 6-Cyl., 15"..... #165..... \$40.95/ea.
- 1957 Bel Air V8, Forged and Anodized Gold, 13"..... #1737..... \$54.95/ea.
- 1957 150 & 210 V8, Chrome, 13"..... #541A..... \$34.95/ea.
- 1957 150 & 210 V8, Chrome, 13"..... #V541A..... \$34.95/ea.
- 1957 150 & 210 V8, Chrome, 13", Import..... #16777..... \$23.95/ea.
- 1957 150 & 210 6-Cyl. Chrome, 15"..... #164..... \$40.95/ea.

Parts 541, 541A, V541, V541A, 164, 165 shown above, contain trademarks of General Motors Corp. and are used by Danchuk Mfg., Inc. under license.

1957 "CHEVROLET" SCRIPT REQUIREMENTS

ENGINE/MODEL	6-CYLINDER 150		6-CYLINDER 210		6-CYLINDER BEL AIR		V8 150 AND 210		V8 BEL AIR	
	PARTS	QUANTITY	PARTS	QUANTITY	PARTS	QUANTITY	PARTS	QUANTITY	PARTS	QUANTITY
HOOD	#164	1	#164	1	#165	1	#541A	1	#541/#1737	1
SIDE	#541A	2	#541A	2	NONE	NONE	#541A	2	NONE	NONE
TRUNK	NONE	NONE	NONE	NONE	NONE	NONE	#541A	1	#541/#1737	1



"CHEVROLET" SCRIPTS



Found on the 150 and 210 models only. In 1955 they were located on the front fenders and in 1956, the rear fenders. Hardware included. **Made in the USA.**

- 1955-56 #540..... \$69.95/pr.



#539



#539A



#2341



#538

"BEL AIR" SCRIPTS



1955 and 56 Chevy's use the chrome Bel Air emblems. On 1955 Bel Air models, they mount above the rear quarter moulding at the front behind the paint divider along with a gold crest emblem. On 1956 models, the same combination was mounted at the top of the quarter at the back by the taillight. On 1957 models, the gold version is mounted on the rear section of the quarter panel insert along with a gold crest. Hardware included. **Made in the USA.**

1955-56 Best, Chrome.....	#538.....	\$64.95/pr.
1955-56 Good, Chrome, Import	#16744.....	\$19.95/ea.
1957 Gold	#539.....	\$64.95/pr.
1957 Chrome	#539A.....	\$64.95/pr.
1957 Forged and Anodized.....	#2341.....	\$85.95/pr.



WARNING! Products on these pages may contain chemicals known to the State Of California to cause cancer and/or birth defects or reproductive harm. www.p65warnings.ca.gov



"NOMAD" TAILGATE SCRIPTS 

Your tailgate can't be without this beautiful script. Gold finished just like the original that adds the right amount of elegance to your tailgate. Approximately 6" in length. Hardware included.

- 1955-57 Best..... #948..... \$15.95/ea.
- 1955-57 Good..... #16799..... \$10.95/ea.



1957 "FUEL INJECTION" SCRIPT 

These were used on the Fuel Injection equipped cars along with the flags emblems shown below. On the 1957 150 models, they mounted on the rear quarter just above the quarter stainless moulding, about five inches from the fin. On Bel-Air and 210 models, they were located on the front fender just above the stainless in front of the door opening. **Made in the USA.**

- 1957..... #382..... \$54.95/ea.



1957 FUEL INJECTION FLAGS EMBLEM

Mounted above Fuel Injection script. Flags cross directly above the "J" in Injection. Distance between top of "J" to flag cross is 1-7/8-inch.

- 1957..... #381..... \$109.95/pr.



UNDER TAILLIGHT V8 EMBLEMS 

These emblems were mounted between the bottom of the taillight and the top of the bumper on all V8 models in 1955 and the Nomad in 1956 to signify the car was V8 equipped. Beautifully chromed and painted these are a must if you have an original V8 car or you have upgraded from the original 6-cylinder. **Made in the USA.***

- 1955..... #384*  \$59.95/pr.
- 1956 Nomad #956..... \$80.95/pr.



MANUFACTURING SCRIPTS AND EMBLEMS

As with all of our American made castings, we start the process with the best virgin zinc on the market. After our crew has inspected each casting, we hand work every part in-house to assure they are perfect prior to plating. All our castings receive a copper buff to assure the show quality plating you have come to expect.



WHEEL SPINNER EMBLEMS  

These spinner emblems are made with the same attention to detail that you find in our hood and trunk emblems. Each emblem is backpainted with true red, white, and blue Chevy colors and then vacuum-metalized for that highly-reflective look. **Made in the USA.**

- 1957-58 #297..... \$54.95/set



CHROME EMBLEMS

Chrome plated custom emblems allow you to add a personal touch to your hot rod, street rod or street machine. Mount with the pins on back or attach with trim adhesive. Measurements are approximate. Hardware included.

All "Blown", 4" x 1-3/4	#14534	\$8.95/ea.
All "Cruisin", 5-1/4" x 2-1/2	#14535	\$8.95/ea.
All "Pro Street", 2-Piece, 8-1/4" x 3	#14536	\$8.95/ea.
All "Streetmachine", 8" x 1-3/4	#14538	\$8.95/ea.
All "Streetrod", 7" x 1-1/2	#14539	\$8.95/ea.

"THE CLASS OF" DASH SCRIPTS

Made from machined stock, these custom dash scripts add a touch of class to your classic. Hardware included.

1955 Silver	#17590	\$66.95/ea.
1955 Gold	#17591	\$66.95/ea.
1956 Silver	#17592	\$66.95/ea.
1956 Gold	#17593	\$66.95/ea.
1957 Silver, 210	#17594	\$66.95/ea.
1957 Gold, 210	#17595	\$66.95/ea.
1957 Silver, Bel Air	#17596	\$66.95/ea.
1957 Gold, Bel Air	#17597	\$66.95/ea.



CUSTOM ENGINE DISPLACEMENT NUMBERS

Install easily with peel and stick adhesive. 1-3/8-inch wide by 5/8-inch tall.

All "0"	#12297	\$20.95/ea.	All "6"	#12302	\$20.95/ea.
All "2"	#12298	\$20.95/ea.	All "7"	#12303	\$20.95/ea.
All "3"	#12299	\$20.95/ea.	All "8"	#12304	\$20.95/ea.
All "4"	#12300	\$20.95/ea.	All "9"	#12305	\$20.95/ea.
All "5"	#12301	\$20.95/ea.			

1955 GRILLE 

Danchuk's master toolmakers created all new tooling for our newest grille. Now smoother than the original, the upper section of the grille where it mounts to the upper support bar was completely reworked and now fits like a glove. We can honestly say this is the finest reproduction grille ever produced. Chrome plated like the original and **Made in the USA.**

1955..... #478..... \$395.95/ea.

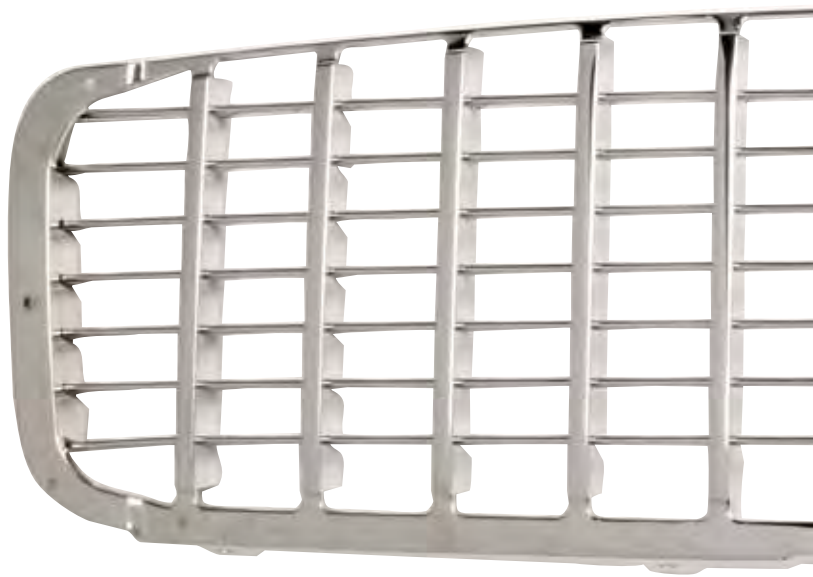

GRILLES

1955 STAINLESS GRILLE

We also offer a stainless version of the '55 grille. We would like to point out, however, that the polished stainless might not reflect the same brilliance and color as the surrounding chrome.

1955..... #10203..... \$549.95/ea.

1956 GRILLE  O/S

Our 1956 grille is stamped and assembled at our California facility, then chrome plated locally making this piece a true American made gem. Factory style rivets are included. See page 30 for grille fasteners.

1956..... #479..... \$384.95/ea.



1956 STAINLESS GRILLE O/S

We also offer a stainless version of the '56 grille. We would like to point out, however, that the polished stainless might not reflect the same brilliance and color as the surrounding chrome.

1956..... #14203..... \$549.95/ea.

1957 GRILLES  O/S

Danchuk makes these grilles exactly as GM made them back in 1957 and as a result you cannot tell our reproduction grille apart from an OE original. Each part is die stamped and then anodized gold for the Bel Air models, or silver for the 210 and 150 models. Danchuk also offers this grille in a chrome plated finish for a custom look. See page 29 for grille fasteners. **Made in the USA.**

1957 150 & 210, Silver..... #460A..... \$139.95/ea.

1957 Bel Air, Gold #460..... \$139.95/ea.

1957 Chrome #460H..... \$199.95/ea.

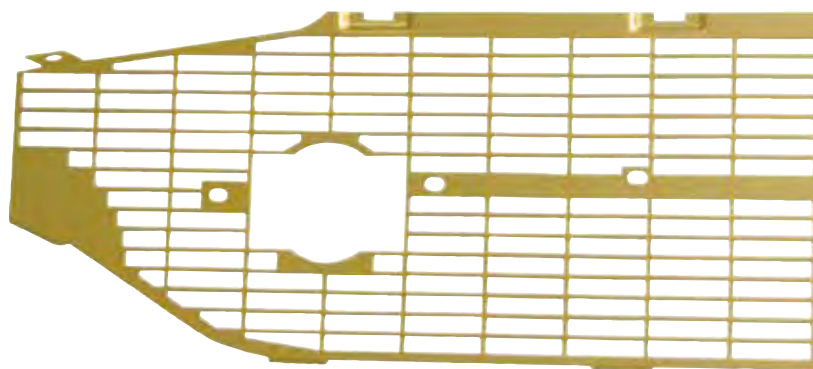

1955



1956



1957

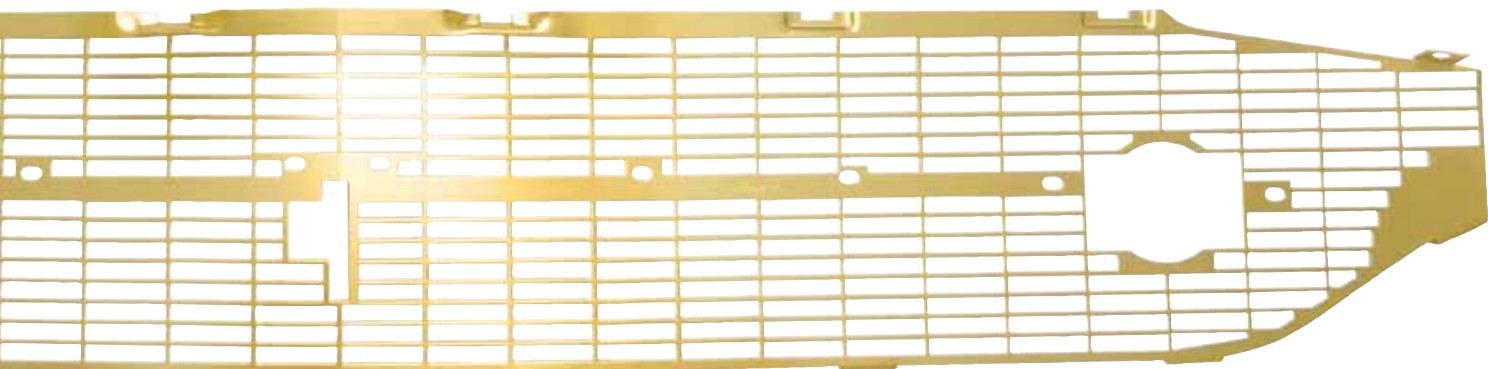

Exterior

CUSTOM GRILLES

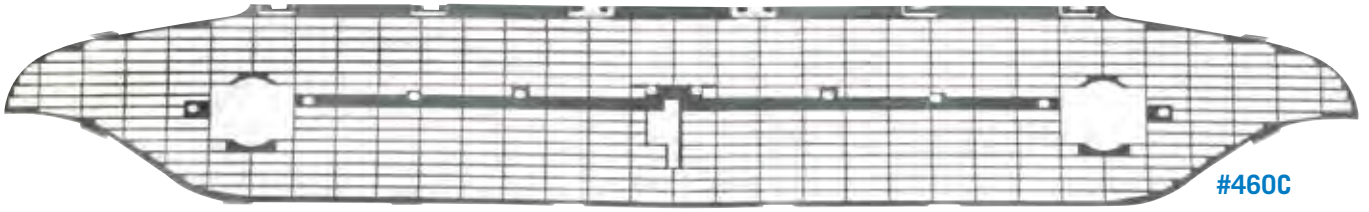

#460C

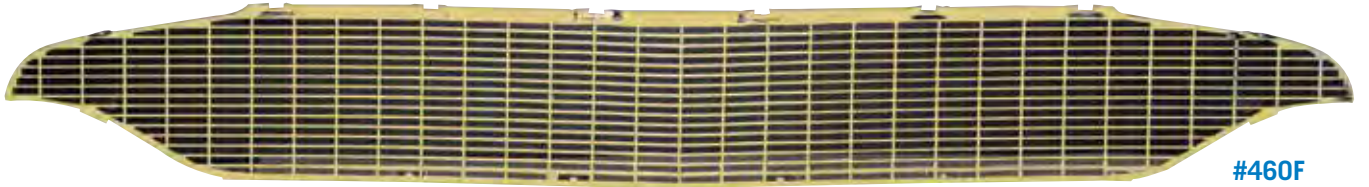

#460F



#460G



#460H

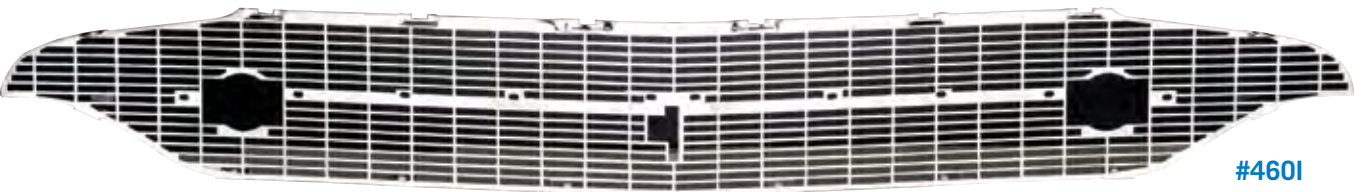

#460I



#460J



#460K

CUSTOM 1957 GRILLES  **O/S**

Danchuk took the existing tooling for the OE 1957 grille and went to work in our tool and die shop to create these custom variations of the original grille. We now have a grille for those who have a 1957 "Smoothie" front bumper, which eliminates the bumper bullet guards, and one that allows you to eliminate the grille bar for a custom look. Both these new grille styles are available in gold, silver anodized or brilliant chrome plating. See pages 29 for grille fasteners. **Made in the USA.** US Patent D654, 834S

1957 Gold, "Smoothie".....	#460B.....	\$189.95/ea.
1957 Silver, "Smoothie".....	#460C.....	\$189.95/ea.
1957 Gold, OE Style, Grille Bar Delete, Bel Air.....	#460D.....	\$179.95/ea.
1957 Silver, OE Style, Grille Bar Delete, 150 & 210.....	#460E.....	\$179.95/ea.
1957 Gold, "Smoothie", Grille Bar Delete.....	#460F.....	\$215.95/ea.
1957 Silver, "Smoothie", Grille Bar Delete.....	#460G.....	\$215.95/ea.
1957 Chrome, "Smoothie".....	#460I.....	\$249.95/ea.
1957 Chrome, OE Style, Grille Bar Delete.....	#460J.....	\$239.95/ea.
1957 Chrome, "Smoothie" Style, Grille Bar Delete.....	#460K.....	\$269.95/ea.



#1564

1955 GRILLE MOULDINGS  **O/S**

Danchuk made the molds for these pieces in our California tool and die shop per the original GM specs and we could not be happier with the results. The only way to tell a Danchuk part from an original is the show quality chrome plating you'll find on these Danchuk parts. **Made in the USA.**

1955 Complete Set (Shown).....	#1564.....	O/S \$499.95/set
1955 Curved Ends Only.....	#1494.....	\$119.95/pr.
1955 Hood Bar Only.....	#10141.....	O/S \$239.95/ea.
1955 Lower Bar Only.....	#12620.....	O/S \$239.95/ea.



#10023

1956 LOWER GRILLE MOULDINGS  **O/S**

This beautifully stamped and chromed jewel installs under the grille and is the perfect way to complete the front trim of your '56. Ours is the only reproduction that is **Made in the USA***.

1956 Best, Chrome.....	#10023*.....	\$379.95/ea.
1956 Good, Polished Stainless.....	#16811.....	\$214.95/ea.



GRILLE BARS

1957 GRILLE BAR ASSEMBLY



Our 1957 grille bar assembly was developed directly from original GM blueprints and an incredibly smooth, hand-polished surface. We manufacture a flush-fitting emblem, mounting kit. Then, we add our lenses, lens gaskets, screws, parklight housings and light it in! Order #424 grille bar harness if needed. Not only is our grille bar superior in qual-
1957.....



1957 GRILLE BAR WIRING CONNECTOR AND GROMMETS

1957..... #18274..... \$17.95/set



1957 GRILLE BAR EMBLEM INSTALLATION KIT



Chevy's original emblem mount tabs didn't last long, so they created this replacement kit. One metal retainer and three rubber cushions hold the emblem firmly in place, and allow the emblem to be removed for cleaning. If you're replacing your emblem, this kit is a must. **Made in the USA.**

1957..... #376..... \$17.95/kit



1957 GRILLE BAR SUPPORT BRACKETS

These are exact reproductions of the much sought after grille bar support bracket.

1957..... #968..... \$26.95/pr.



1957 GRILLE BAR WINGED SPEED NUTS

These speed nuts secure the back of the 1957 grille bar to the grille. Use with #2861 Winged Speed Nut Fastening Tool, below. Two required per car.

1957 3/16" #969..... \$2.95/pr.

1957 3/16" #16827 \$2.75/ea.



WINGED SPEED NUT FASTENING TOOL

1957-64 #2861 \$35.95/ea.



#966

you can't get any closer to original than that. Our seven-step chrome plating highlights backpainted in true red, white and blue, and mount it to the grille bar with a removable bulbs. All you need to do is install the included parklights, fasten it to your grille and plug it, it is the best value on the market. **Made in the USA.**

..... #966 \$419.95/ea.



1957 GRILLE CLIPS AND SCREWS

Don't mount a beautiful new '57 grille with old hardware. 1957..... #072..... \$20.95/set

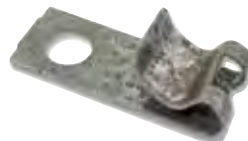

1957 GRILLE BAR HARNESS TO INNER FENDER CLIP

A quick inspection usually reveals the grille bar harness clips are long gone. Protect this harness from damage by properly securing it to the inner fender. Two clips are needed per car.

1957..... #1882..... \$3.95/ea.



Thanks for sending your photo!

BARBARA FROM ARDMORE, OKLAHOMA



GRILLE TIE BAR ADJUSTER BRACKETS

- 1956 Black #14563.....\$18.95/pr.
- 1956 Stainless..... #14564.....\$28.95/pr.

TOP OF GRILLE BOLT SET-FAKE RIVET HEAD 

Tooled from scratch, our grille bolts look like exact replicas of the original rivets used in '55 and '56. Not only are the bolt heads the exact dimensions of the originals, we went even further by plating them with a black phosphate coating just like GM. Don't settle for an incorrect size and finish when Danchuk has what you need. **Made in the USA.**
 1955-56 #510..... \$18.95/set



#10205

#10204

#14204

#14205

#1835

GRILLE TIE BARS  **O/S**

The top edge of your grille attaches to this piece making it the first thing you see when you lift the hood, so you want your tie bar to be flawless. Danchuk's black tie bars are exact reproductions of GM originals but if you want to jazz things up a bit, we also offer them in chrome. **Made in the USA.***

1955 Black	#10204.....	\$64.95/ea.
1955 Chrome	#10205.....	\$119.95/ea.
1956 Black	#14205.....	\$69.95/ea.
1956 Chrome	#14204.....	\$119.95/ea.

1957 GRILLE SUPPORT BAR  **O/S**

The top edge of the aluminum grille is secured to the grille support bar. Reproduced according to original dimensions and specifications.

1957.....	#1835.....	\$94.95/ea.
-----------	------------	-------------



One of the most distinctive aspects of the mid-fifties Chevys are the beautiful hood birds. The focal point of your car shouldn't be neglected. We have spared no expense in the tooling for these birds, and we spend hours on hand work preparing them for plating. If your hood bird is pitted or showing its age, don't waste your money on a fill and chrome job. Replace that faded glory with these top-notch Danchuk parts. Gaskets included. **Made in the USA.***



#472

1955 HOOD BIRDS

1955 Best w/ Gasket.....	#472*	\$164.95/ea.
1955 Good	#16706	\$114.95/ea.



HOOD BARS AND EXTENSIONS

Danchuk makes these hood bars and extensions right here in our California tool and die. Once we get the raw casting we hand work, fit and inspect each and every one before they hood bar and extensions match perfectly with even gaps and contours. **Made in the USA.**

1956 HOOD BAR AND EXTENSIONS

1956 Bar.....	#461	\$249.95/ea.
1956 Extensions.....	#14793	\$189.95/pr.
1956 Bar & Extensions	#14791	\$399.95/set



#484

1956 HOOD BIRDS

1956 Best w/ Gasket.....	#484*	\$164.95/ea.
1956 Good	#16707	\$114.95/ea.



#14791



#14792

shop. We spent over a year perfecting the molds and our efforts have paid off ten-fold. are sent off for the best quality chrome plating money can buy. Put together as a set, our

1957 HOOD BAR AND EXTENSIONS

1957 Bar.....	#474		\$239.95/ea.
1957 Extensions.....	#473		\$179.95/pr.
1957 Bar & Extensions	#14792		\$399.95/set

WARNING! Products on these pages may contain chemicals known to the State Of California to cause cancer and/or birth defects or reproductive harm. www.p65warnings.ca.gov

1957 HOOD ROCKETS 

1957 hood rockets are actually three pieces which, when put together, look like one solid part because they fit together so precisely. Die cast from the finest zinc, each casting is hand worked and fitted before it is sent out for the best chrome plating money can buy. Hood Rocket brackets are sold separately, see part # 2340. **Made in the USA***.



1957 Best, Complete Assembly	#467*	\$299.95/set
1957 Good, Complete Assembly	#16755	\$219.95/set
1957 Hood Rockets Only.....	#469*	\$119.95/pr.
1957 Hood Scoops Only.....	#470*	\$119.95/pr.
1957 Backing Plates Only	#468*	\$119.95/pr.



1957 HOOD ROCKET BRACKETS

These are the under-hood brackets you need to correctly mount the rocket assembly to your hood. It takes the correct hardware to do the job right.

1957.....	#2340.....	\$24.50/pr.
-----------	------------	-------------

HOOD BIRD GASKETS 

Although they were not originally used by GM, many collectors shudder at the thought of mounting their hood birds without these precision die cut parts. They fit as if Detroit had planned it that way. **Made in the USA.**

1955.....	#918.....	\$7.95/set
1956.....	#919.....	\$7.95/ea.

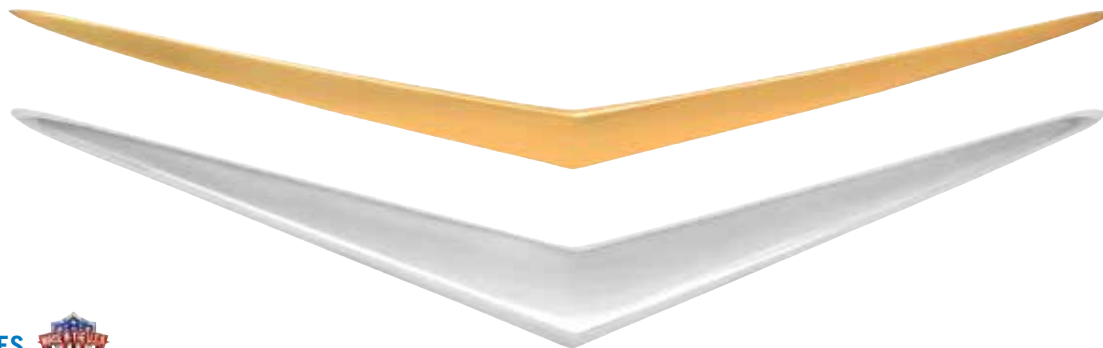

#590

#1041

HOOD VEES 

GM used hood vee emblems to signify that the car was equipped with the V8 engine. Bel Air models used a gold finished vee while the 150 and 210 used a chrome version. Includes mounting hardware. **Made in the USA.***

1956 Best, V8	#1041*	\$54.95/ea.
1956 Good, V8	#16721	\$49.95/ea.
1957 Best, Bel Air, V8	#590*	\$119.95/ea.
1957 Best, 150 & 210, V8.....	#590A*	\$119.95/ea.



1955 CUSTOM ROCKER PANEL MOULDINGS O/S

There are two kinds of 1955 owners: ones who like gravel shields and ones who don't. If you are one of the many that loves all the beautiful stainless trim that made these masterpieces the iconic cars they are, but just don't like the look or fit of gravel shields, we've got the rocker panel moulding option GM should have given you. We have simply taken the originally designed, **Made in the USA** mouldings and duplicated the rear gentle curve on the front. Same look and mounting hardware but NO gravel shield needed or recommended. Enjoy!

1955 Custom Rocker Panel Mouldings..... #17784..... \$215.95/pr.



ROCKER PANEL MOULDINGS O/S

#696

These stainless steel rocker panel mouldings are a must for the aging auto. No matter which year car you own, this popular accessory will add sparkle. **Made in the USA***, we've upgraded our 1957 mouldings by constructing them entirely of stainless steel. Even though they are mounted in an area that is prone to moisture, this new design makes them long-lasting. The **Made in the USA** mouldings include mounting clips and nuts.

#697

1955 Best	#696*	\$215.95/pr.
1955 Good, w/o Clips	#16715	\$134.95/pr.
1956 Best	#697*	\$215.95/pr.
1957 Best	#537C*	\$215.95/pr.



FRONT GRAVEL SHIELDS

These stainless steel stampings are the companions to the rocker panel mouldings for the 55-56 models. They help to protect from the unexpected and are a beautiful finishing touch. **Please use caution when installing and do not over tighten the nuts. If studs break off the vendor recommends you use epoxy like JB weld and will not warranty broken studs.**

1955	#790	\$139.95/pr.
1956	#720A	\$141.95/pr.



#704

#695

#698

ROCKER PANEL MOULDING CLIP SETS

Keep those beautiful stainless steel rocker panel mouldings securely fastened where they belong. Never mount new mouldings with old mounting hardware.

1955	#695	\$17.95/set
1956	#698	\$17.95/set
1957 Stainless, Danchuk Mldgs...	#704	\$24.95/set

DANCHUK STAINLESS STEEL SIDE MOULDINGS

Just like we did for the 1956 and 1957 models, we tooled up to produce these beautiful side stainless mouldings for both two and four door 1955 models. Danchuk's master toolmakers created the tooling in-house and the mouldings themselves are stamped from the most beautifully polished top quality "Auto Brite" stainless available. Mounting clips are sold separately; see pages 59 and 60. **Made in the USA.**



#17544



#17534/17535

#17536

1955 BEL AIR SIDE MOULDINGS - BEST, MADE IN THE USA!



1955 Front Fender, Driver, All except Nomad (Shown above).....	#17534	O/S	\$64.95/ea.
1955 Front Fender, Passenger, All except Nomad (Shown above)	#17535	O/S	\$64.95/ea.
1955 Front of Door, Driver, All except Nomad (Shown above)	#17536		\$54.95/ea.
1955 Front of Door, Passenger, All except Nomad.....	#17537		\$54.95/ea.
1955 Door Point, Driver, 2-Door Sedan	#17538		\$54.95/ea.
1955 Door Point, Passenger, 2-Door Sedan.....	#17539		\$54.95/ea.
1955 Door Point, Driver, 2-Door Hardtop & Convertible	#17540		\$54.95/ea.
1955 Door Point, Passenger, 2-Hardtop & Convertible	#17541		\$54.95/ea.
1955 Quarter Panel, Driver, 2-Door Hardtop, Sedan & Convertible	#17542	O/S	\$144.95/ea.
1955 Quarter Panel, Passenger, 2-Door Hardtop, Sedan & Convertible	#17543	O/S	\$144.95/ea.
1955 Door, Rear, Driver, 4-Door Sedan & Wagon	#17544		\$119.95/ea.
1955 Door, Rear, Passenger, 4-Door Sedan & Wagon	#17545		\$119.95/ea.
1955 Quarter Panel, Driver, 4-Door Sedan & Wagon	#17546	O/S	\$119.95/ea.
1955 Quarter Panel, Passenger, 4-Door Sedan & Wagon	#17547	O/S	\$119.95/ea.

See pages 59 and 60 for moulding clip sets.

1955 BEL AIR SIDE MOULDINGS - GOOD

1955 Front Fender, Driver, All except Nomad.....	#700	O/S	\$57.95/ea.
1955 Front Fender, Passenger, All except Nomad	#701	O/S	\$57.95/ea.
1955 Front of Door, Driver, All except Nomad	#702		\$44.95/ea.
1955 Front of Door, Passenger, All except Nomad.....	#703		\$44.95/ea.
1955 Door Point, Driver, 2-Door Sedan	#716		\$41.95/ea.
1955 Door Point, Passenger, 2-Door Sedan.....	#717		\$41.95/ea.
1955 Door Point, Driver, 2-Door Hardtop & Convertible.....	#721		\$49.95/ea.
1955 Door Point, Passenger, 2-Door Hardtop & Convertible	#722		\$49.95/ea.
1955 Quarter Panel, Driver, 2-Door Hardtop, Sedan & Convertible	#723	O/S	\$121.95/ea.
1955 Quarter Panel, Passenger, 2-Door Hardtop, Sedan & Convertible	#724	O/S	\$121.95/ea.

See pages 59 and 60 for moulding clip sets.

#705/706



#718/719

1955 210 SIDE MOULDINGS

1955 Door Point, Driver Side, 210, 2-Door Sedan & Wagon.....	#705		\$36.95/ea.
1955 Door Point, Passenger Side, 210, 2-Door Sedan & Wagon	#706		\$36.95/ea.
1955 Quarter Panel, Driver Side, 210, 2-Door	#718	O/S	\$99.95/ea.
1955 Quarter Panel, Passenger Side, 210, 2-Door	#719	O/S	\$99.95/ea.

See pages 59 and 60 for moulding clip sets.



UPPER PAINT DIVIDER MOULDINGS

1955 210 2 & 4-Door Sedan..... #19061..... \$179.95/pr.
 1956-57 210 2 & 4-Door Sedan... #19062..... \$199.95/pr.



1955 UPPER PAINT DIVIDERS BLACK INSERT DECALS

See page 38 for 1956 versions.

1955 Hardtop..... #17397..... \$9.95/pr.
 1955 Sedan #17399..... \$9.95/pr.

PAINT DIVIDER MOULDING CLIPS

These OE style reproduction molding clips are used to attach the vertical paint divider mouldings on all 1955-1956 models and 1957 150 models. These zinc plated steel clips include SAE threaded nuts. Six required per car. Measures 1-inch x 1-3/4-inch.

1955-56 All, 1957 150 Only, 6-Piece
 #18838..... \$17.95/set
 1955-56 All, 1957 150 Single Clip
 #18694..... \$2.95/ea.

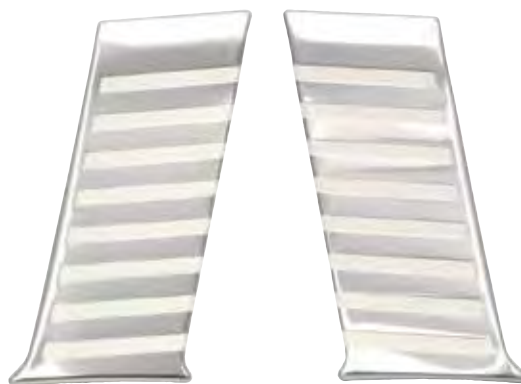

1955 PAINT DIVIDERS

We stamp each paint divider from polished stainless steel and paint them white to match the side mouldings. The paint dividers are essential on the two-tone model, but add a nice touch to one-color cars as well. Mounting hardware included. **Made in the USA.**

1955 210 & Bel Air exc. Nomad, Wagon
 #152..... \$52.95/set



1955 ACCESSORY GAS DOOR GUARD

In our opinion, this accessory should have come stock. Not only does it jazz up that quarter panel, but it helps to prevent paint chipping under the gas door. All our tooling and parts for this gem are **Made in the USA.** Fuel door bumper and screws are included.

1955 exc. Nomad #489..... \$28.95/ea.



CLOSE UP

MOLDABLE EXTERIOR MOULDINGS

This moldable aluminum moulding is the perfect accent or custom detail you are looking for. Made from mill finish 6063-T0 aluminum, these are easily polished to a mirror finish. Measures .71-inch on the backside with a .61-inch curved section on the front that cuts into .25" inverted curve section. Easily attaches with 3M high strength adhesive backing. Can be drilled and tapped if needed.

All 4-ft. Length Only #18796A..... \$54.95/ea.
 All 6-ft. Length Only #18796..... \$74.95/ea.
 All 8-ft. Length Only #18797..... \$99.95/ea.
 All (2) 8-ft., (2) 6-ft., (2) 4-ft. and 3M Adhesive Backing #18798..... \$423.95/kit



1956 BEL AIR 4-DOOR SIDE MOULDINGS - MADE IN THE USA! 

Just like we did for the 1955 and 1957 models, Danchuk's master toolmakers produced these beautiful side stainless mouldings for both two and four door 1956 models. They created the tooling in-house and the mouldings themselves are stamped from the most beautifully polished top quality "Auto Brite" stainless available. Mounting clips are sold separately; see pages 59 and 60. **Made in the USA.**

1956 4-Door, Door, Front, Lower Driver/Upper Passenger, Hardtop.....	#17124.....	\$54.95/ea.
1956 4-Door, Door, Front, Upper Driver/Lower Passenger, Hardtop.....	#17125.....	\$54.95/ea.
1956 4-Door, Door, Rear, Driver, Hardtop	#17126.....	\$119.95/ea.
1956 4-Door, Door, Rear, Passenger, Hardtop.....	#17127.....	\$119.95/ea.
1956 4-Door, Door, Front, Lower Driver/Upper Passenger, Sedan	#17130.....	\$54.95/ea.
1956 4-Door, Door, Front, Upper Driver/Lower Passenger, Sedan	#17131.....	\$54.95/ea.
1956 4-Door, Door, Rear, Driver, Sedan.....	#17132.....	\$119.95/ea.
1956 4-Door, Door, Rear, Passenger, Sedan	#17133.....	\$119.95/ea.
1956 4-Door, Quarter Panel, Driver, Hardtop	#17128.....	O/S \$119.95/ea.
1956 4-Door, Quarter Panel, Passenger, Hardtop.....	#17129.....	O/S \$119.95/ea.
1956 4-Door, Quarter Panel, Driver, Sedan.....	#17134.....	O/S \$119.95/ea.
1956 4-Door, Quarter Panel, Passenger, Sedan	#17135.....	O/S \$119.95/ea.

Note: See pages 59 and 60 for moulding clip sets.



#17398

#17400

#17401

1956 UPPER PAINT DIVIDERS BLACK INSERT DECALS

See page 37 for 1955 versions.

1956 Hardtop.....	#17398.....	\$9.95/pr.
1956 Sedan	#17400.....	\$9.95/pr.
1956 Nomad	#17401.....	\$9.95/pr.

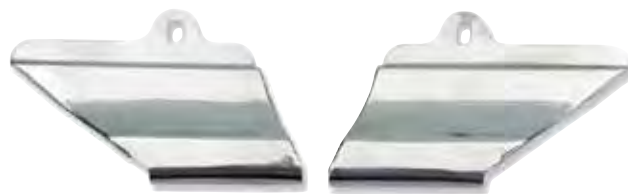

1956 FRONT FENDER PAINT DIVIDERS

These attach under the front fender moulding and wrap around the fender lip to give a nice clean division of paint colors.

1956 150 & 210	#699.....	\$28.95/pr.
----------------------	-----------	-------------



#17128-17129 / #17134-17135

#17124-17125

#17126-17127

#17130-17131

#17132-17133

1956 BEL AIR 2 AND 4-DOOR SIDE MOULDINGS - BEST, MADE IN THE USA!

1956 2-Door, Door, Lower Driver/Upper Passenger	#17312.....	\$54.95/ea.
1956 2-Door, Door, Upper Driver/Lower Passenger	#17313.....	\$54.95/ea.
1956 2-Door, Quarter Panel, Driver	#17314 O/S	\$136.95/ea.
1956 2-Door, Quarter Panel, Passenger	#17315 O/S	\$136.95/ea.
1956 2 & 4-Door, Fender Spear Point, Driver & Passenger.....	#17311.....	\$54.95/ea.
1956 2 & 4-Door, Fender, Upper Passenger/Lower Driver	#17316.....	\$54.95/ea.
1956 2 & 4-Door, Fender, Lower Passenger/Upper Driver	#17317.....	\$54.95/ea.

Note: See pages 59 and 60 for moulding clip sets.

1956 BEL AIR 2 AND 4-DOOR SIDE MOULDINGS - GOOD

1956 2-Door, Door, Lower Driver/Upper Passenger	#714.....	\$44.95/ea.
1956 2-Door, Door, Upper Driver/Lower Passenger	#715.....	\$44.95/ea.
1956 2-Door, Quarter Panel, Driver	#729 O/S	\$111.95/ea.
1956 2-Door, Quarter Panel, Passenger	#730 O/S	\$111.95/ea.
1956 2 & 4-Door, Front Fender Spear Point, Driver & Passenger	#711.....	\$39.95/ea.
1956 2 & 4-Door, Fender, Upper Passenger/Lower Driver	#712.....	\$46.95/ea.
1956 2 & 4-Door, Fender, Lower Passenger/Upper Driver	#713.....	\$46.95/ea.

Note: See pages 59 and 60 for moulding clip sets.



#731-732

1956 150 AND 210 SIDE MOULDINGS

1956 2 & 4-Door, 150 & 210, Fender, Driver	#725.....	\$62.95/ea.
1956 2 & 4-Door, 150 & 210, Fender, Passenger	#726.....	\$62.95/ea.
1956 2-Door, Door, 150 & 210, Driver	#727.....	\$62.95/ea.
1956 2-Door, Door, 150 & 210, Passenger	#728.....	\$62.95/ea.
1956 2-Door, Quarter Panel, 210, Driver	#731 O/S	\$111.95/ea.
1956 2-Door, Quarter Panel, 210, Passenger	#732 O/S	\$111.95/ea.

Note: See pages 59 and 60 for moulding clip sets.

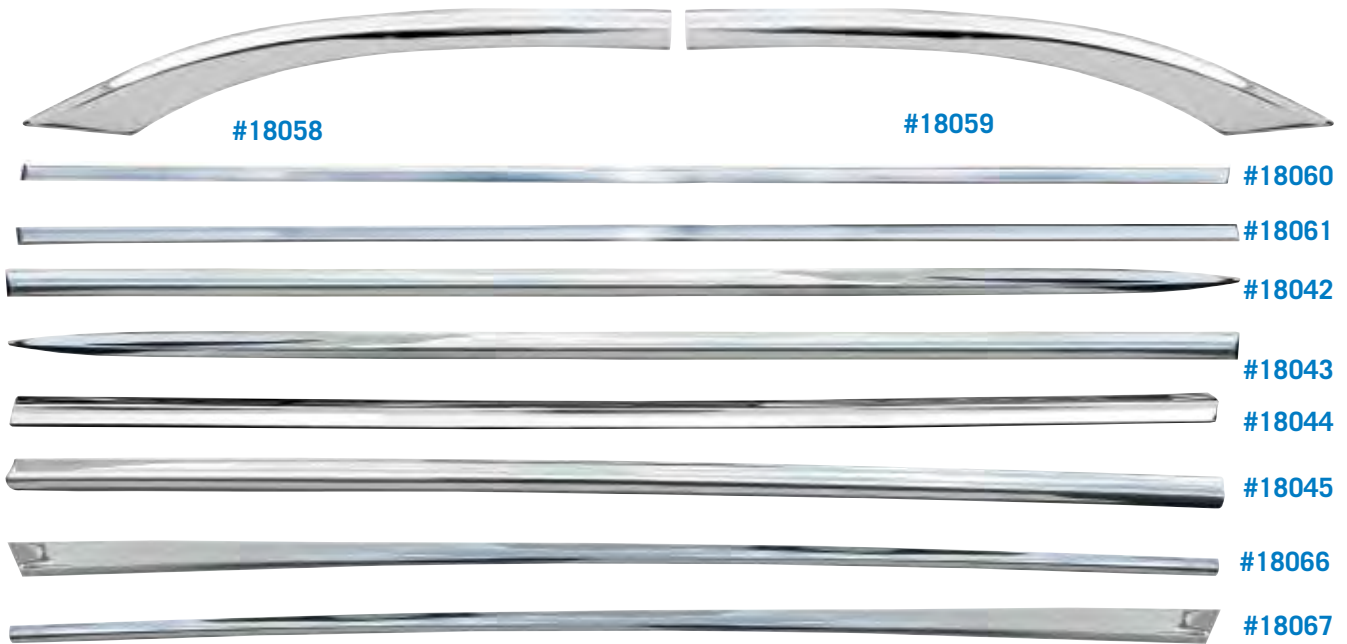

1957 210 AND BEL AIR SIDE STAINLESS MOULDINGS - BEST, MADE IN THE USA 

Just like we did for the 1955 and 1956 models, Danchuk's master toolmakers produced these beautiful side stainless mouldings for both two and four door 1957 models. They created the tooling in-house and the mouldings themselves are stamped from the most beautifully polished top quality "Auto Brite" stainless available. Mounting clips are sold separately; see pages 59 and 60. **Made in the USA.**

1957 Fender, Driver, 210 & Bel Air 2 & 4-Door	#18042	O/S	\$74.95/ea.
1957 Fender, Passenger, 210 & Bel Air 2 & 4-Door.....	#18043	O/S	\$74.95/ea.
1957 Door, Driver, 210 & Bel Air 2-Door.....	#18044		\$74.95/ea.
1957 Door, Passenger, 210 & Bel Air 2-Door	#18045		\$74.95/ea.
1957 Door, Driver, 210 & Bel Air 4-Door Hardtop	#18046		\$54.95/ea.
1957 Door, Passenger, 210 & Bel Air 4-Door Hardtop.....	#18047		\$54.95/ea.
1957 Door, Driver, 210 & Bel Air 4-Door Sedan & Wagon	#18048		\$54.95/ea.
1957 Door, Passenger, 210 & Bel Air 4-Door Sedan & Wagon.....	#18049		\$54.95/ea.
1957 Rear Door, Lower, Driver, 210 & Bel Air 4-Door Hardtop.....	#18050		\$54.95/ea.
1957 Rear Door, Lower, Passenger, 210 & Bel Air 4-Door Hardtop	#18051		\$54.95/ea.
1957 Rear Door, Curved Upper, Driver, 210 & Bel Air 4-Door Hardtop.....	#18052		\$54.95/ea.
1957 Rear Door, Curved Upper, Passenger, 210 & Bel Air 4-Door Hardtop	#18053		\$54.95/ea.
1957 Rear Door, Lower, Driver, 210 & Bel Air 4-Door Sedan & Wagon.....	#18054		\$54.95/ea.
1957 Rear Door, Lower, Passenger, 210 & Bel Air 4-Door Sedan & Wagon	#18055		\$54.95/ea.
1957 Rear Door, Curved Upper, Driver, 210 & Bel Air 4-Door Sedan & Wagon.....	#18056		\$54.95/ea.
1957 Rear Door, Curved Upper, Pngr, 210 & Bel Air 4-Door Sedan & Wagon.....	#18057		\$54.95/ea.
1957 Quarter Curved, Upper Driver, 210 & Bel Air 2-Door.....	#18058		\$49.95/ea.
1957 Quarter Curved, Upper Passenger, 210 & Bel Air 2-Door	#18059		\$49.95/ea.
1957 Quarter Long, Upper Driver, 210 & Bel Air, 2-Door	#18060	O/S	\$74.95/ea.
1957 Quarter Long, Upper, Passenger, 210 & Bel Air 2-Door.....	#18061	O/S	\$74.95/ea.
1957 Quarter Long, Upper, Driver, 210 & Bel Air 4-Door Hardtop.....	#18062	O/S	\$119.95/ea.
1957 Quarter Long, Upper, Passenger, 210 & Bel Air 4-Door Hardtop	#18063	O/S	\$119.95/ea.
1957 Quarter Long, Upper, Driver, 210 & Bel Air 4-Door Sedan & Wagon	#18064	O/S	\$119.95/ea.
1957 Quarter Long, Upper, Passenger, 210 & Bel Air 4-Door Sedan & Wagon.....	#18065	O/S	\$119.95/ea.
1957 Quarter Long, Lower, Driver, 210 & Bel Air, All 2-Door	#18066	O/S	\$156.95/ea.
1957 Quarter Long, Lower, Passenger, 210 & Bel Air, All 2-Door.....	#18067	O/S	\$156.95/ea.
1957 Quarter Long, Lower, Driver, 210 & Bel Air, 4-Door Hardtop.....	#18068	O/S	\$156.95/ea.
1957 Quarter Long, Lower, Passenger, 210 & Bel Air, 4-Door Hardtop	#18069	O/S	\$156.95/ea.
1957 Quarter Long, Lower, Driver, 210 & Bel Air, 4-Door Sedan & Wagon.....	#18070	O/S	\$156.95/ea.
1957 Quarter Long, Lower, Passenger, 210 & Bel Air, 4-Door Sedan & Wagon	#18071	O/S	\$156.95/ea.

Note: See pages 59 and 60 for moulding clip sets.

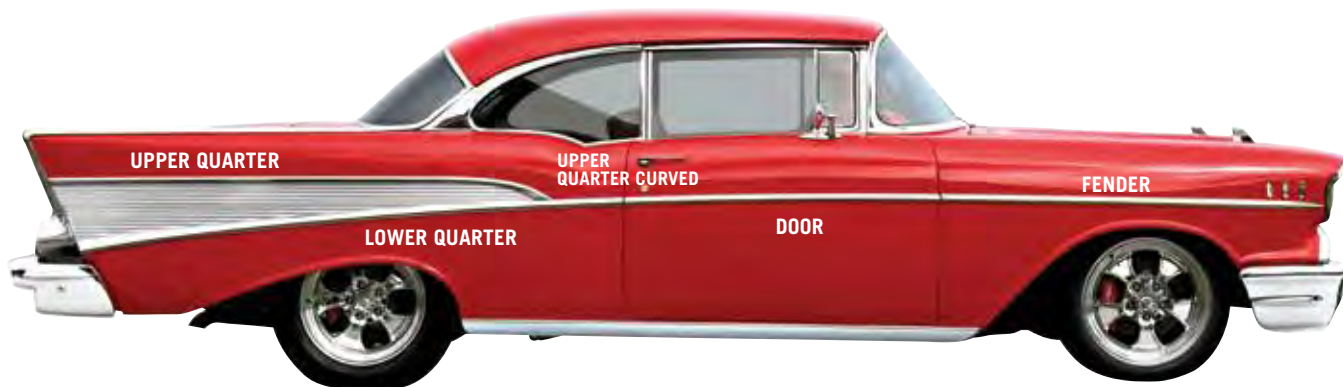

1957 210 AND BEL AIR SIDE STAINLESS MOULDINGS - GOOD

1957 Upper Quarter Curved Piece, Driver Side, All 2-Door	#707.....		\$44.95/ea.
1957 Upper Quarter Curved Piece, Psngr. Side, All 2-Door.....	#708.....		\$44.95/ea.
1957 Upper Quarter Straight Piece, Driver Side, All 2-Door	#709.....	O/S	\$68.95/ea.
1957 Upper Quarter Straight Piece, Psngr. Side, All 2-Door	#710.....	O/S	\$68.95/ea.
1957 Front Fender, Driver Side, All 2 & 4-Door.....	#761.....	O/S	\$65.95/ea.
1957 Front Fender, Passenger Side, All 2 & 4-Door	#762.....	O/S	\$65.95/ea.
1957 Door, Driver Side, All 2-Door.....	#763.....		\$65.95/ea.
1957 Door, Passenger, All 2-Door.....	#764.....		\$65.95/ea.
1957 Lower Quarter, Driver Side, All 2-Door.....	#765.....	O/S	\$149.95/ea.
1957 Lower Quarter, Passenger Side, All 2-Door	#766.....	O/S	\$149.95/ea.

Note: See pages 59 and 60 for moulding clip sets.



1957 150 SIDE STAINLESS MOULDINGS O/S



These mouldings are highly polished and have been duplicated according to original specifications including the slight bend on the ends. 4-piece set, driver and passenger side quarter mouldings and door points.

1957 Rear Quarter & Door Point #19435..... \$599.95/set



1957 REAR DECK LID MOULDING KIT O/S

This highly sought after trim kit installs across the bottom of the trunk lid and finishes off on the rear filler panels. Due to the variables in tolerances on cars built in the 1950's, some fitting may be required. Even GM was aware of this and it was noted on the installation instructions. **Made in the USA.** Will not work on Nomad, wagon or sedan delivery.



1957 Hardware Included - Call for Availability #535..... \$249.95/kit

1957 Hardware Only #535A..... \$25.95/kit



1957 BILLET ALUMINUM DECK LID MOULDING KIT O/S

This custom deck accessory is machined out of aluminum and attaches using 3M trim tape.

1957 3-Piece #17156..... \$298.95/kit

Exterior

1957 SIDE PANEL INSERTS



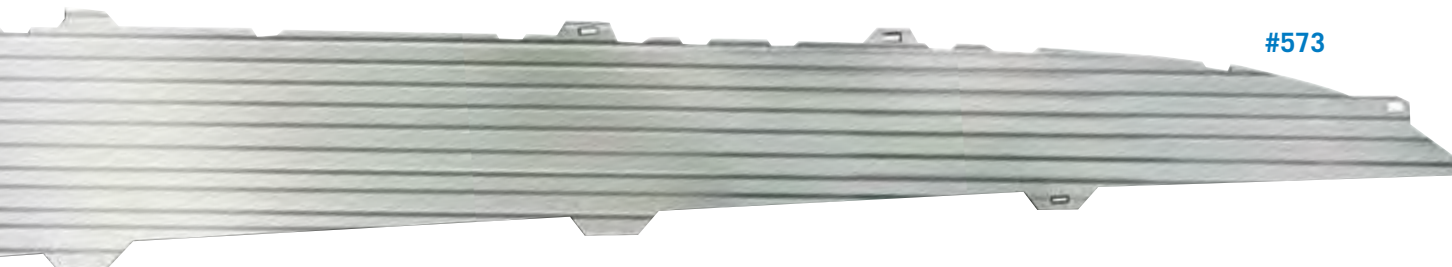

#573

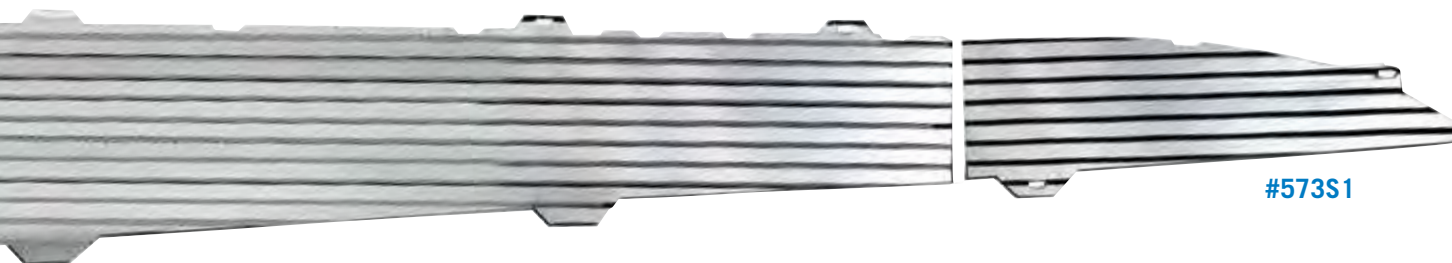

#573S1



#573-P 9" X 72" MATERIAL ONLY

1957 ALUMINUM SIDE PANEL INSERTS



When we introduced our Bel Air side panel inserts in 1978, we established our reputation as Tri-Five leaders. These panels are stamped from the finest aluminum available. The grooves are precision-cut to the original depth and width, showing off the subtle contrast between the polished ridges and the buff-finished grooves. After the intricate, multiple step process of material preparation is complete, we use first class American tooling to perfectly shape the panels, and most importantly put the complex contour at the back of the panel so they fit perfectly against the contour in the quarter panels. All parts are **Made in the USA**.

1957 Bel Air 2-Door Hardtop, Sedan, Convertible, Nomad & Wagon (Shown)	#573 (Shown)	\$699.95/pr.
1957 Bel Air 4-Door Hardtop	#573A	\$699.95/pr.
1957 Bel Air 4-Door Sedan & Wagon	#573B	\$699.95/pr.
1957 Bel Air 2-Door Hardtop, Sedan, Convertible, Nomad & Wagon, No Holes, No Emblems	#573C	\$669.95/pr.
1957 Bel Air 2-Door Hardtop, Sedan, Convertible, Nomad & Wagon, Chrome Emblems	#573D	\$699.95/pr.
1957 Bel Air 2-Door Hardtop, Sedan, Convertible, Nomad & Wagon w/ Forged Emblems	#573S	\$699.95/pr.
1957 Bel Air 4-Door Hardtop w/ Forged Emblems	#573S1 (Shown)	\$699.95/pr.
1957 Bel Air 4-Door Sedan w/ Forged Emblems	#573S2	\$699.95/pr.
1957 Bel Air 2-Door Hardtop, Sedan, Convertible, Nomad & Wagon, Economy Line	#B573	\$425.00/pr.
All Insert Material Only, 9" x 72"	#573-P (Shown)	\$225.95/ea.

#14790



#11947

1957 TOP OF FIN MOULDING AND INSERT  **O/S**

We guarantee you will be thrilled with the quality and fit of this beautiful piece. Our insert is an exact reproduction of the original. We built the tooling ourselves in our Santa Ana in-house tooling department and manufacture them right here also. **Made in the USA***.

1957 Moulding, Bel Air exc. Nomad & Wagon.....	#14790*	\$129.95/ea.
1957 Insert w/ Pins Attached, Bel Air exc. Nomad & Wagon	#11947*	\$78.95/ea.
1957 Moulding w/ Insert, Bel Air exc. Nomad & Wagon	#14790A*	\$189.95/ea.
1957 Moulding, 150 & 210	#17429	\$64.95/ea.
1957 Retainer w/ Pins, 150 & 210	#17430	\$54.95/ea.



#18668

1957 VERTICAL AND TOP OF FIN MOULDINGS WITH GAS DOOR

This is a custom one-piece version of the top of fin moulding and vertical moulding in one unit. Very neat and perfect for that custom upgrade that people just can't put their finger on.

1957 Driver, 150 & 210.....	#18668	\$279.95/ea.
1957 Passenger, 150 & 210	#18669	\$279.95/ea.

#17201

#12142
COMPLETE
SET

#17200

#17202



1957 STAINLESS VERTICAL FIN MOULDINGS - DRIVER QUALITY

1957 Complete, Rear w/ Gas Door	#12142	\$349.95/set
1957 Passenger	#17200	\$155.95/ea.
1957 Driver	#17201	\$109.95/ea.
1957 Gas Door Filler.....	#17202	\$109.95/ea.



1957 TOP OF FIN MOULDING PINS

These moulding pins are assembled into the 1957 fin mouldings. The moulding pin assembly is then inserted into the fin moulding clips, parts #1073 or #622, mounted in the top of the fin. The Bel Air set contains 22 pins, and the 210 and 150 set contains six pins. Each set contains enough pins for both top of the fin mouldings.

1957 Bel Air (Shown)	#1051	\$40.95/set
1957 150 & 210	#1455	\$17.95/set

1957 TOP OF FIN MOULDING CLIPS



These sets of clips mount into the top of the 1957 tail fins on the Bel Air, 210, and 150 models. These clips receive the mouldings with moulding pins. See fin moulding pin sets, part #1051 and #1455, shown left. The Bel Air set contains 22 clips, and the 210 and 150 set contains six clips. Each set contains enough clips for both fins.

1957 Bel Air.....	#622	\$19.95/set
1957 150 & 210 (Shown).....	#1073	\$6.95/set



DOOR BELT MOULDINGS



These door belt mouldings install at the top of the door below the window opening and are made to exacting specifications from the finest materials to provide a perfect fit and look. **Made in the USA***.

- 1955-57 Driver, Hardtop & Convertible #15671* \$65.95/ea.
- 1955-57 Passenger, Hardtop & Convertible #15672* \$65.95/ea.
- 1955-57 Driver and Passenger, Hardtop & Convertible #16515* \$114.95/pr.
- 1955-57 Fits Driver or Passenger, 210 2-Door Sedan #18516..... \$79.95/ea.



CONVERTIBLE QUARTER BELT MOULDINGS

Made from beautiful stainless steel these mouldings install on the outside at the top of the quarter panel at the window opening.

- 1955-57 Stainless..... #17655.....\$443.95/pr.



CENTER POST BELT STAINLESS MOULDINGS

This is the center post beltline moulding which keeps the continuity of the belt line mouldings on the front and rear doors of 4-door sedans.

- 1955-57 Bel Air 4-Door Sedan #17000.....\$44.95/pr.



4-DOOR CENTER POST SIDE MOULDINGS

These long awaited chrome mouldings are finally available and includes hardware.

- 1956 Bel Air, Sedan, 4-Piece #16865..... \$74.95/set
- 1956 Bel Air, Hardtop, 4-Piece..... #16866..... \$74.95/set
- 1957 210 & B/A, Sedan, 2-Piece . #16867..... \$54.95/set
- 1957 210 & B/A, Hardtop, 2-Piece#16868..... \$54.95/set



REAR QUARTER BELT MOULDING SCREWS

- 1955-57 Convertible..... #17656..... \$3.50/set
- 1955-57 2-Door Hardtop..... #17657..... \$3.50/set



1957 FIN CORNER RETAINING CLIPS

This clip installs on the 1957 fin to help mount the vertical fin moulding.

- 1957..... #12706.....\$11.95/pr.



1957 FIN MOULDING SCREWS

- 1957 Stainless #15424 \$4.95/set



OUTSIDE REAR VIEW MIRRORS WITH LED TURN SIGNAL

These replacement mirrors feature a polished stainless head, as original, and a chrome plated base. They also have a 9 LED arrow hidden inside the mirror glass. These mirrors fit both sides, just rotate the head to point the arrow in the correct direction. Includes a base gasket and mounting hardware. Easy to hook up, just route the wires through your door and under the dash and connect them to the front turn signal wires under the dash near the steering column.
1955-57 #16993..... \$34.95/ea.
1955-57 Convex, Passenger Only . #17589..... \$37.95/ea.

OUTSIDE REAR VIEW MIRRORS



Originally an accessory item, this mirror is recognized today as a driving and appearance standard. Featuring a stainless steel head and chrome base this mirror boasts some of the best **Made in the USA*** workmanship you can get. Fits both driver and passenger sides. Gasket and mounting hardware included.
1955-57 Best..... #531* \$69.95/ea.
1955-57 Good..... #16743..... \$39.95/ea.



OUTSIDE REAR VIEW MIRRORS WITH LED SIGNAL

Passenger mirror is convex.
1955-1957 #19134.....\$69.95/pr.



REAR VIEW, WIDE ANGLE CONVEX MIRROR FOR PASSENGER SIDE

This rear view mirror features a convex mirror that gives you a wide angle view for better rear vision and helps avoid the dreaded blind spot on the passenger side. Meant for use on passenger side only.
1955-57 Passenger Only..... #16820..... \$24.95/ea.



1956 FENDER BIRDS

“Fifties Modern” sculpture for the top of your fenders! Add a little flash with this die-cast and chrome plated accessory.

1956..... #648..... \$199.95/pr.



1956 FENDER EXTENSIONS

These **Made in the USA*** parts are exactly like GM made them over 60 years ago. They visually create the appearance that they are part of the grille assembly.

1956 Best #356* \$149.95/pr.

1956 Good #16739..... \$89.95/pr.



#530B



1957 FENDER LOUVERS

Our fender louvers are anodized gold for the Bel Air and silver for the 210 (can be added to the 150). Also, we offer a beautiful custom chrome version. We improved upon the design by adding a threaded stud to the back for easy installation. This enhancement, plus the Danchuk quality, has made these louvers a highly sought after part.

Made in the USA.

1957 Bel Air..... #530..... \$49.95/set

1957 210 #530A..... \$54.95/set

1957 Chrome #530B..... \$74.95/set



1956 FENDER EXTENSION INNER SUPPORT BRACKETS

These unseen support brackets install at the bottom of the fender in front of the wheel well. The fender extensions are installed on these brackets.

1956 Best #1114..... \$34.95/pr.

1956 Good #16751..... \$24.95/pr.

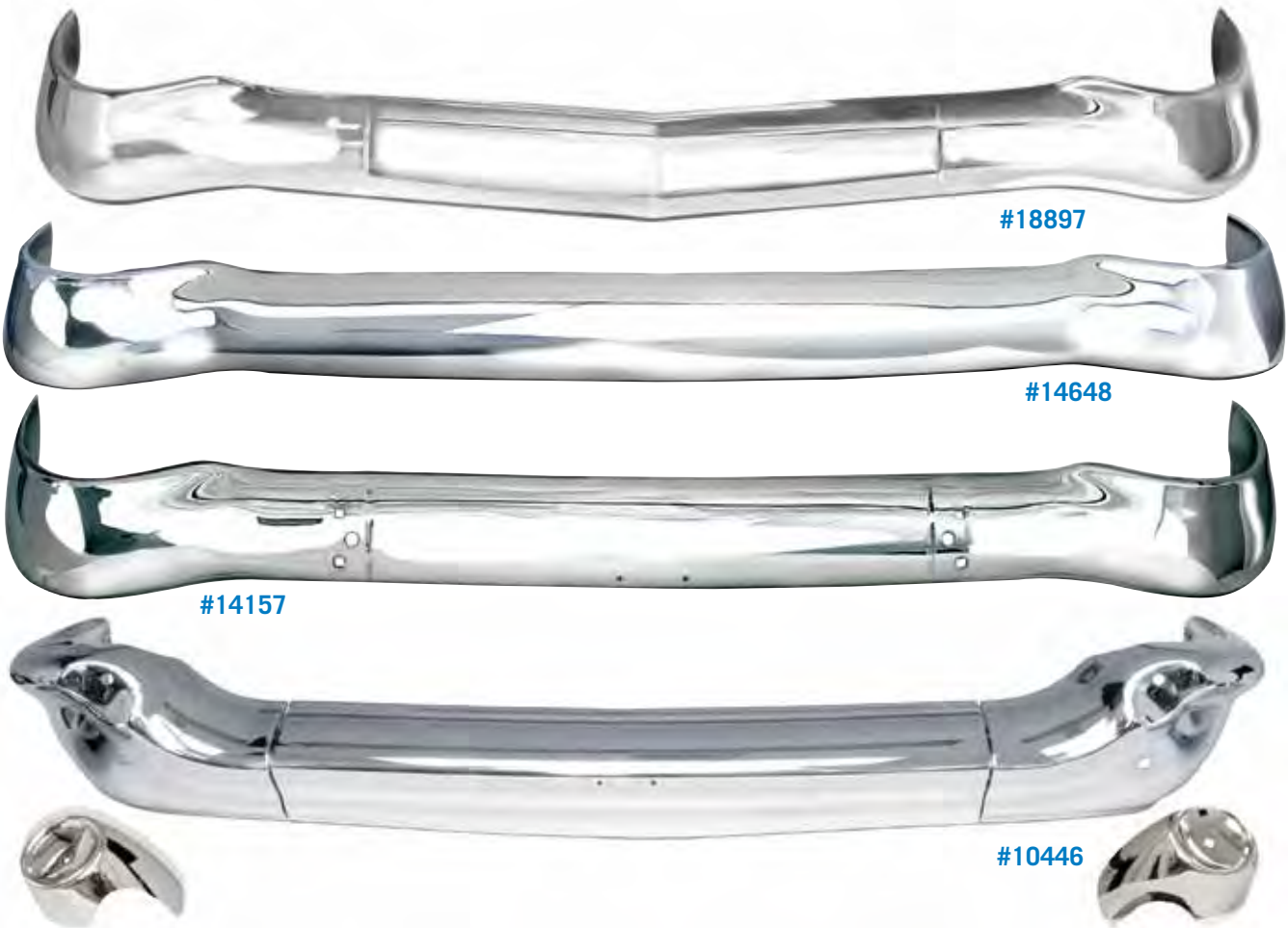

FRONT BUMPERS O/S

Gone are the days of expensive and long drawn out re-works. All of our bumpers are simply beautiful, effortless and reasonably priced. Five-piece, three-piece, one-piece or custom "Smoothie" options available.

1955 1-Piece	#14157	\$539.95/ea.
1955 1-Piece "Smoothie", Complete w/ Brackets, Use with #14648A.....	#14648.....	\$699.95/set
1955 3-Piece	#10245.....	\$449.95/set
1955 7-Piece, w/ Bumper to Frame Brackets.....	#16039.....	\$364.95/set
1956 1-Piece	#15226.....	\$569.95/ea.
1956 1-Piece "Smoothie".....	#18897.....	\$699.95/ea.
1956 3-Piece	#10247.....	\$449.95/set
1957 5-Piece	#10446.....	\$579.95/set



1955 PAINT TO MATCH "SMOOTHIE" BUMPERS O/S

The same stamping as our chrome versions but with no finish so you can paint, powdercoat, whatever to match your project or imagination.

1955 1-Piece, Front.....	#19387.....	\$439.95/ea.
1955 1-Piece, Rear	#19388.....	\$464.95/ea.



13524



#14655

FRONT BUMPER BRACKETS

These brackets are precision engineered to original specs.

1955 Driver, Center	#1896.....	\$34.95/ea.	1957 Driver, Quarter	#1228.....	\$34.95/ea.
1955 Passenger, Center.....	#1897.....	\$34.95/ea.	1957 Passenger, Quarter.....	#1229.....	\$34.95/ea.
1955 Driver, Quarter	#1220A.....	\$34.95/ea.	1957 Driver, Center	#13512.....	\$35.95/ea.
1955 Passenger, Quarter.....	#1221A.....	\$34.95/ea.	1957 Passenger, Center.....	#13513.....	\$35.95/ea.
1955 Driver, Fender	#1219.....	\$34.95/ea.	1957 Driver, Fender	#12615.....	\$34.95/ea.
1955 Passenger, Fender	#1218.....	\$34.95/ea.	1957 Passenger, Fender	#12616.....	\$34.95/ea.
1955 Complete Set, OE Style, 6-Piece			1957 Driver, Diagonal	#13516.....	\$35.95/ea.
.....	#14655.....	\$189.95/set	1957 Passenger, Diagonal	#13517.....	\$35.95/ea.
1956 Driver, Center	#12327.....	\$25.95/ea.	1957 Driver, Jack Brace.....	#13514.....	\$35.95/ea.
1956 Passenger, Center	#12328.....	\$25.95/ea.	1957 Passenger, Jack Brace	#13515.....	\$35.95/ea.
1956 Driver, Quarter	#1224.....	\$32.95/ea.	1957 Complete Set, 10-Piece	#13524.....	\$379.95/set
1956 Passenger, Quarter.....	#1225.....	\$32.95/ea.			
1956 Driver, Fender	#1223.....	\$25.95/ea.			
1956 Passenger, Fender	#1222.....	\$25.95/ea.			



WARNING! Products on these pages may contain chemicals known to the State Of California to cause cancer and/or birth defects or reproductive harm. www.p65warnings.ca.gov



1957 CHROME BUMPER BULLETS - MADE IN THE USA! 

These bullets are die cast and triple chrome plated to give your front end the beautiful custom look it deserves. Choose from the original design or our full custom "Smoothie" look. **Made in the USA.**

1957 Original Style.....	#330A.....	\$99.95/pr.
1957 "Smoothie" Style.....	#330B.....	\$99.95/pr.

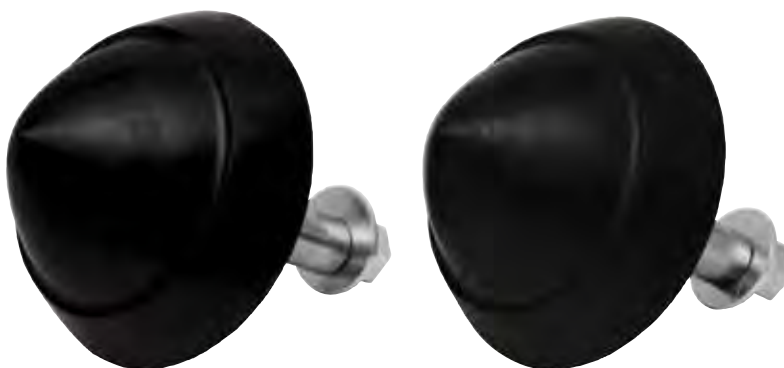

1957 RUBBER BUMPER BULLETS 

This popular accessory will mount onto any 1957 Chevy bumper. Made from hard rubber this bumper bullet comes with the mounting stud attached. **Made in the USA*.**

1957 Best.....	#330*.....	\$41.95/pr.
1957 Good.....	#16738.....	\$38.95/pr.



1957 BUMPER INSERTS

This metal insert was standard equipment on all 57's, but was removed to install the rubber bumper bullets, part #330 shown above.

1957.....	#13525.....	\$35.95/set
-----------	-------------	-------------



1957 FRONT BUMPER BULLET GUARDS

These bumper bullet guards are required with our one-piece 1957 bumper #15937. Mounting hardware included.

1957.....	#10448.....	\$169.95/set
-----------	-------------	--------------



#18898

REAR BUMPERS O/S

New bumpers should be mounted with new brackets and mounting kits for maximum strength and safety. Mounting kits are found on page 53.

1955 1-Piece, Hardtop, Sedan & Convertible	#15228.....	\$569.95/ea.
1955 1-Piece "Smoothie", Hardtop, Sedan & Conv., Complete w/ Brackets	#15228A.....	\$699.95/set
1955 3-Piece, Hardtop, Sedan & Convertible.....	#1798.....	\$449.95/set
1955 3-Piece, Nomad & Wagon	NEW #19386.....	\$549.95/set
1956 1-Piece, "Smoothie".....	#18898.....	\$699.95/ea.
1956 1-Piece, Hardtop, Sedan & Convertible w/ Guards	#15227.....	\$569.95/set
1956 3-Piece, Hardtop, Sedan & Convertible	#10558.....	\$469.95/set
1956 3-Piece, Hardtop, Sedan & Convertible w/ Guards	#10558A.....	\$569.95/set
1956 3-Piece, Nomad & Wagon, No Guard Holes	NEW #19290.....	\$449.95/set
1957 3-Piece, Hardtop, Sedan & Convertible	#10447.....	\$569.95/set
1957 3-Piece, Nomad & Wagon	#10447A.....	\$569.95/set
1957 3-Piece, Nomad & Wagon, No Guard Holes	#10447B.....	\$569.95/set

REAR CENTER BUMPERS O/S

For those who just need the center section of their bumper, Danchuk now offers three different versions for you. The part #1845 fits the hardtops, sedans and convertibles, but for those who want to move the license plate off of the trunk and to the bumper we now offer the highly sought after Nomad/Wagon centers #1846 and #1846A. The #1846A goes one step further by eliminating the bumper guard holes for a cleaner custom look. Part #1846A requires use of a lighted license plate frame. See pages 56 and 57 for lighted license plate frames.

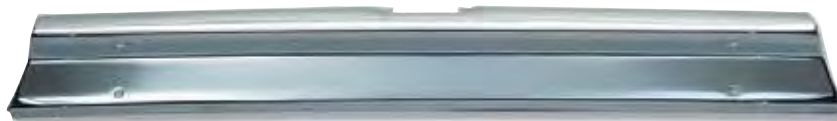

1956 Nomad & Wagon, No Guard Holes.....	#19421.....	\$299.95/ea.
1957 Hardtop, Sedan & Convertible.....	#1845.....	\$299.95/ea.
1957 Nomad & Wagon.....	#1846.....	\$299.95/ea.
1957 Nomad & Wagon No Guard Holes.....	#1846A.....	\$299.95/ea.



#1230



#12330



#12329



#16037

REAR BUMPER BRACKETS

These brackets are precision engineered to original specs for a perfect fit.

1955 Passenger, Center.....	#1896.....	\$34.95/ea.	1956 Driver, Center	#12329.....	\$27.50/ea.
1955 Driver, Center	#1897.....	\$34.95/ea.	1956 Passenger, Center.....	#12330.....	\$27.50/ea.
1955 Driver, Quarter	#12617.....	\$34.95/ea.	1957 Driver, Quarter	#1230.....	\$32.95/ea.
1955 Passenger, Quarter.....	#12618.....	\$34.95/ea.	1957 Passenger, Quarter.....	#1231.....	\$32.95/ea.
1956 Driver, Quarter	#1226.....	\$32.95/ea.	1957 Center Only.....	#16037.....	\$38.95/pr.
1956 Passenger, Quarter	#1227.....	\$32.95/ea.			



BUMPER GUARDS

These fine reproductions feature all the contours designed into the original parts. The rear guards include holes for mounting license light assemblies, parts #485B and #485C, found on page 81. Includes mounting hardware.

1955 Front	#1004.....	\$163.95/pr.
1955 Rear exc. Nomad & Wagon.....	#1005.....	\$165.95/pr.
1955 Rear Nomad & Wagon	#1005A.....	\$189.95/pr.
1956 Front	#1408.....	\$179.95/pr.
1956 Rear exc. Nomad & Wagon.....	#1409.....	\$209.95/pr.
1956 Rear Nomad & Wagon w/ Hardware	#18497.....	\$239.95/pr.
1956 Rear Nomad & Wagon w/ Lights and Bezels.....	#18526.....	\$289.95/pr.
1957 Front, w/ Hardware.....	#17682.....	\$249.95/pr.



1956 REAR ACCESSORY BUMPER GUARD HARDWARE

This hardware kit will attach the accessory rear bumper guards to the bumper.

1956.....	#17414.....	\$59.95/ea.
-----------	-------------	-------------

1956 ACCESSORY BUMPER GUARD SCREWS

This set of stainless steel hardware consists of four slotted oval head bolts with hex nuts. Heads can be polished to a mirror-like finish.



1956 Rear.....	#2259.....	\$13.95/set
----------------	------------	-------------

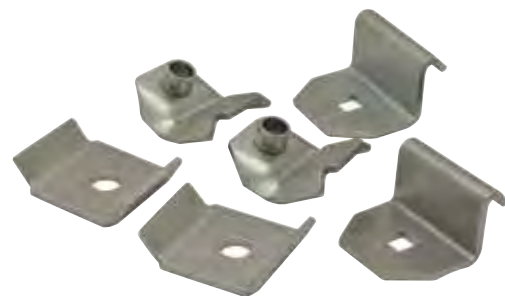

1957 ACCESSORY BUMPER GUARD HARDWARE

This hardware kit has special spacers and clamps necessary to attach accessory front and rear bumper guards to the bumpers on 1957 Chevy's. Two for front and two for rear included.

1957.....	#14695.....	\$33.95/set
-----------	-------------	-------------



1957 BUMPER ENDS O/S

Danchuk bumper ends are the finest reproduction bumper ends on the market. From their excellent fit to their impeccable chrome plating these Second Series bumper ends are just what your 57 needs to shine. Black insert decals are included.

1957 Second Series #757 \$399.95/pr.



1955 FRONT SMOOTHIE BUMPER MOUNTING KIT

This bolt kit has just what you need to mount the 1955 front "Smoothie" bumper, part #14648.

1955..... #14648A..... \$14.95/kit



1957 REAR BUMPER END BRACKETS

1957..... #17894..... \$64.95/pr.

FRONT BUMPER MOUNTING HARDWARE

This complete bumper kit has all the nuts, bolts and washers you need to install your front bumper including the stainless steel-capped bumper bolts, which are almost indistinguishable from the chrome bumper after polishing. All remaining hardware is cad plated.

1955-56 #937 \$18.95/kit



REAR BUMPER MOUNTING HARDWARE

This complete bumper kit has all the nuts, bolts and washers you need to install your rear bumper including the stainless steel-capped bumper bolts, which are almost indistinguishable from the chrome bumper after polishing. All remaining hardware is cad plated.

1955..... #938..... \$18.50/kit

1956..... #939..... \$18.50/kit



1957 BUMPER MOUNTING HARDWARE

These complete bumper kits have all the nuts, bolts and washers you need to install the front or rear bumpers on your 1957 including the stainless steel-capped bumper bolts, which are almost indistinguishable from the chrome bumper after polishing. All remaining hardware is cad plated.

1957 Front #1009 \$33.95/set

1957 Rear #1010 \$34.95/set



BACK BODY-TO BUMPER SEALS

Protect your car from dirt and dust with these important seals. Without them, dirt will come up from underneath your bumper onto your trunk and rear window. Seals are reproduced with the correct cross-section and length. Long lasting and easy to install. **Made in the USA.**



1955.....	#549.....	\$26.95/ea.
1956.....	#550.....	\$17.95/ea.
1957.....	#551.....	\$19.95/ea.

1955 BUMPER END TO BODY BELL SPACERS

These install between the driver and passenger side curved bumper ends and the body where the long bumper bolt installs.



These prevent overtightening the bolt and damaging the quarter panel.

1955.....	#11288.....	\$14.95/pr.
-----------	-------------	-------------



1955 BUMPER BOLT WITH NUT

1955 Stainless, 7/16" x 2-1/2"

.....	#12707.....	\$3.95/ea.
-------	-------------	------------

BUMPER BOLT

Sold individually, these bolts are a great solution for those missing just a few parts. Stainless steel-capped for easy polishing. 7/16-inch x 1-1/4-inch.



1955-72	#049.....	\$1.95/ea.
---------------	-----------	------------

1957 REAR BUMPER END INSERT DECALS

Our reproduction bumper ends, part #757, shown on page 53, are detailed with these decals. These bumper end insert decals are die-cut in a matte black, adhesive-backed vinyl. **Made in the USA.**



1957.....	#331.....	\$10.95/set
-----------	-----------	-------------

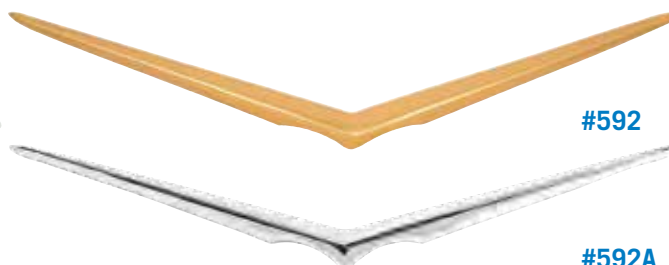

TRUNK VEEES

Designed with depressions on the underside to assist in opening the trunk. The 1957 stamping was a particularly difficult part to reproduce, but we're proud to say that this one's a real show-stopper! The 1956 chrome vee is equally beautiful. All 1956 V8's and 1957 150 and 210 V8's require a chrome vee. 1957 Bel Air V8's require the gold finished version. Installation hardware included.

Made in the USA*.

1956 Best, V8	#1042*	\$54.95/ea.
1956 Good, V8	#16722.....	\$49.95/ea.
1957 Best, Bel Air, V8	#592*	\$119.95/ea.
1957 Best, 150 & 210, V8.....	#592A*	\$119.95/ea.
1957 Good, 150 & 210.....	#16714.....	\$62.95/ea.



NOMAD TAILGATE VEEES

This gold finished reproduction was originally designed to fit the 1957 Nomad and 1957 Continental Kit. We also offer a chrome-plated version for use on the 1958 Continental kit. Includes mounting hardware. Vees are 7.5-inch long.

Made in the USA.

1957 Nomad & Continental Kit, V8

.....	#591	\$38.95/ea.
1958 Continental Kit, V8.....	#591A.....	\$39.95/ea.



NOMAD TAILGATE CENTER BARS AND HANDLE

1955-57 Handle Only, Nomad & Pontiac Safari	#10151.....	\$89.95/ea.
1955-1957 Center Tailgate Bar ONLY, Late 1955 Chevy Nomad & Pontiac Safari ..	#10152... O/S	\$199.95/ea.
1955-57 Bars Only, Nomad & Pontiac Safari	#10153.....	\$424.95/set
1955-57 Complete Set Bars & Handle, Nomad & Pontiac Safari.....	#10150... O/S	\$599.95/set



NOMAD TAILGATE CLIPS

Sold in five piece sets, these clips securely mount the unique "bananas", found exclusively on the Nomad. One set does one bar. Seven sets required.

1955-57 #1247 \$16.95/set



TAILGATE HANDLE WITH BUTTON AND KEYS FOR WAGON AND SEDAN DELIVERY

1955-57 #16538..... \$224.95/set



NOMAD TAILGATE COMPLETE CLIP SET

33-Pieces.

1955-57 #15426 \$79.95/set



WAGON TAILGATE/ SEDAN DELIVERY REAR DOOR HANDLE GASKETS

1955-57 #848 \$2.95/ea.



Photo courtesy of GERTMAN2000



1957 LICENSE PLATE FRAMES  

Our highly detailed frames are produced in gold finish for the Bel Air and chrome for the 150 and 210. Mounting hardware included. **Made in the USA.**

1957 Bel Air.....	#189.....	\$79.95/ea.
1957 150 & 210	#189A.....	\$79.95/ea.

#17577



#17576

BILLET SPECIALTIES LICENSE PLATE FRAMES WITH LIGHTS 

These are made to provide a license plate light in applications where you eliminate the stock license light. Available with a plain front, etched bowtie emblem or a third brake light. **Made in the USA.**

All Plain.....	#17575.....	\$59.95/ea.
All w/ Third Brake Light.....	#17576.....	\$79.95/ea.
All w/ Bowtie	#17577.....	\$74.95/ea.

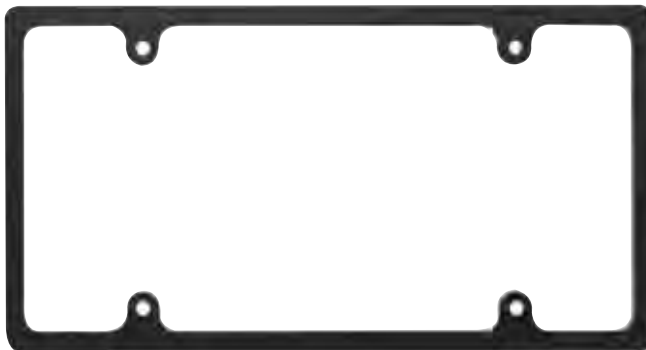

BILLET SPECIALTIES SLIM LINE LICENSE PLATE FRAMES 

All Black	#18404.....	\$24.95/ea.
All Polished.....	#17146.....	\$27.95/ea.



1956 ACCESSORY CHROME LICENSE PLATE FRAME
 1956..... #1171 \$74.95/ea.



LICENSE PLATE FRAME WITH LED LIGHTS

With 14 super bright LED's these frames can be used for a variety of custom applications. Use the white LED frame as an additional backup light and the red LED frame is perfect for use as an additional stoplight. Includes mounting hardware and screw cover caps.

All White LED's #16821 \$34.95/ea.
All Red LED's #16822 \$24.95/ea.



1957 REAR LICENSE PLATE HARDWARE
 1957..... #17658..... \$4.95/set

TRUNK LID-TO-LICENSE PLATE CUSHIONS

Goes between the license bracket (55-56) or the plate (57) and the trunk lid. Includes the rubber bumper to insert in the lower hole for the bottom edge of the plate. **Made in the USA.**
 1955-57 #071 \$3.95/set



FRONT LICENSE PLATE BRACKETS

These license plate brackets are a necessity if your state requires a front plate. Painted in durable black and **Made in the USA***

1955 Best	#608*	\$17.95/ea.
1955 Good	#16786	\$9.95/ea.
1956 Best	#608A*	\$17.95/ea.
1956 Good	#16787	\$9.95/ea.
1957 Best	#608B*	\$17.95/ea.
1957 Good	#16788	\$9.95/ea.



REAR LICENSE PLATE BRACKET

Incorporates all the detail of the original, including the rubber bumper. Fits all models except Station Wagon, Nomad and Sedan Delivery. **Made in the USA.**

1955-56 #148 \$24.95/ea.

LED LICENSE PLATE BOLTS

These license plate bolts can be used anywhere. Additional wiring is required and have a stainless housing w-nylon bolts. Perfect for those running smoothie bumpers or those who have removed their rear bumper guards.
All White #16823 \$11.95/pr.





1957 CONTINENTAL KIT TIRE RINGS **O/S**
1957 Plain #11352..... \$174.95/ea.
1957 Chrome #11353..... \$319.95/ea.



1957 CONTINENTAL KIT CARRIER ASSEMBLY
1957..... #11344..... \$146.95/ea.



1957 CONTINENTAL KIT FACE PLATE
1957..... #11351..... \$149.95/ea.



1957 CONTINENTAL KIT LOCK SUPPORT ASSEMBLY PAD
1957 #14221..... \$78.95/ea.



CONTINENTAL KIT RING SPRING
1955-57 #11349..... \$22.95/ea.



#11345

1957 CONTINENTAL KIT BUMPER TO FRAME BRACKETS
1957 Left #11345..... \$66.95/ea.
1957 Right #11345A..... \$66.95/ea.



CONTINENTAL KIT JACK BOLT
1955-57 #17914..... \$11.95/kit



CONTINENTAL KIT BAR SPACER
1955-57 #11350..... \$49.95/ea.



CONTINENTAL KIT LOCK BOLT SPRING RETAINER
1955-57
..... #11347. \$31.95/set



1957 CONTINENTAL KIT BACK PAD CUP RETAINER
Requires two.
1957.... #11346. \$20.95/ea.



UNIVERSAL MOULDING CLIPS

After investing in new paint and exterior mouldings, finish the job by replacing those tired fasteners. Don't risk your beautiful stainless steel mouldings on fasteners that are over 60 years old. Match your original to the part in the photographs above (not actual size). These fasteners are sold individually; see moulding clip sets for complete kits.

1955-57 1-1/16" x 1"	#632.....	\$0.95/ea.
1955-57 1/2" x 5/8"	#633.....	\$0.50/ea.
1955-57 1-7/8" x 5/8"	#634.....	\$1.95/ea.
1955-57 1-1/2" x 1/2"	#635.....	\$2.50/ea.
1955-57 3/4" x 5/16"	#636.....	\$1.95/ea.
1955-57 2-1/2" x 3/4" Threaded .	#639.....	\$1.75/ea.



WINGED SPEED NUT FASTENING TOOL

For use with parts #2860 and #16827, shown below.
 1957-64 #2861 \$35.95/ea.



WINGED SPEED NUT FASTENERS

These are universal speed nuts that will work with or without threaded studs. 3/16-inch are used for the front grille bar on '57's, two required. 1/8-inch are used in various places through out the car. Use with Danchuk #2861 fastening tool.
 1957-64 1/8", 25-Pieces #2860 \$36.95/set
 1955-57 3/16" #16827 \$2.75/ea.



SIDE WINDOW UPPER AND LOWER MOULDING CLIPS

Includes all clips and screws to attach the beltline and window area stainless trim including the end clips.

1955-57 Bel Air 2-Door Sedan	#2263.....	\$84.95/set
1955-57 Bel Air 4-Door Sedan (Shown)	#2264.....	\$106.95/set

REAR QUARTER WINDOW MOULDING CLIPS

One set does both sides.

1955-57 Upper, Bel Air 2-Door Sedan	#1076.....	\$21.95/set
1955-57 Upper & Lower, Bel Air 2-Door Sedan	#1077.....	\$23.95/set



WINDOW MOULDING CONNECTORS

Made in the USA*.

1955-57 exc. 1955 150, Best, Lower Windshield	#2056*	\$13.95/ea.
1955-57 exc. 1955 150 Good, Lower Windshield	#16807.....	\$6.95/ea.
1955-57 exc. 1955 150 & Conv., exc. 56-57 Conv., Upper Windshield	#2057.....	\$13.95/ea.
1955-57 Sedan, 2-Door Hardtop, Best, Lower Rear	#2058*	\$13.95/ea.
1955-57 Sedan, 2-Door Hardtop, Good, Lower Rear	#16808.....	\$6.95/ea.
1956-57 4-Door Hardtop, Lower Rear	#2059.....	\$13.95/ea.



MOULDING CLIP SETS

Each set contains all the clips you'll need to mount the mouldings on both sides of your car. These are replacement clips; some have been substituted for the original design, but are functionally equivalent. Please note: Clips for upper and lower paint dividers in #281 may need to be trimmed to fit. **NOTE: All prices are for set unless otherwise noted as each. Miscellaneous clip sets can be found in both headings. Made in the USA.**

SIDE MOULDING CLIP SETS

YEAR	MODEL	APPLICATION	PART #	PRICE
55-57	All	Rear Window Moulding Clips	#247	\$8.95
1955	B/A exc. Nomad	Front Fender	#278	\$15.95
1955	B/A exc. Nomad	Door	#279	\$18.95
1955	B/A exc. Nomad	Long Quarter Panel	#280	\$21.95
1955	B/A exc. Nomad	Qtr. Panel Paint Divider	#281	\$13.95
1955	210	Door & Qtr Panel Paint Divider	#283	\$12.95
1955	210	Long Qtr Panel	#284	\$18.95
1955	Nomad	Front Fenders	#11305	\$3.95
1955	Nomad	Doors	#11306	\$35.95
1956	Bel Air	Front Fender	#268	\$19.95
1956	Bel Air	Front Door	#269	\$36.95
1956	Bel Air	Quarter Panel Paint Divider	#270	\$9.95
1956	Bel Air	Long Quarter Panel	#271	\$25.95
1956	Bel Air	4-Door Adapter	#272	\$29.95
1956	150 & 210	Front Fender	#273	\$13.95
1956	150 & 210	Front Door	#274	\$14.95
1956	150 & 210	Quarter Panel Paint Divider	#275	\$9.95
55-56	All, 1957 150	Paint Divider	#18694	\$2.95
1956	210	Long Quarter Panel	#276	\$25.95
1956	210	4-Door Adapter	#277	\$14.95
1956	150	Short Quarter	#18658	\$8.95
1956	All	4-Door Adapter	#18659	\$9.95
1957	210 & Bel Air	Front Fender	#261	\$14.95
1957	210 & Bel Air	Front Door	#262	\$14.95
1957	210 & Bel Air	Upper Quarter Panel	#263	\$25.95
1957	210 & Bel Air	Long Lower Quarter Panel	#264	\$25.95
1957	210 & Bel Air	4-Door Adapter	#265	\$12.95
1957	150	Door & Qtr Panel Paint Divider	#266	\$12.95
1957	150	Long Quarter Panel	#267	\$22.95
1957	210 & Bel Air	Upper Quarter Connector	#12716	\$5.95

BELT & SIDE WINDOW MOULDING CLIP SETS

YEAR	MODEL	APPLICATION	PART #	PRICE
55-57	210 2-Door Sedan	Replacement Style	#1024	\$38.95
55-57	210 4-Door Sed.	Replacement Style	#1025	\$48.95
55-57	210 & Bel Air 2-Door Wagon	Replacement Style	#1026	\$55.95
55-57	210 & Bel Air 4-Door Wagon	Replacement Style	#1027	\$69.95
55-57	210 2-Door Wgn	Upper Quarter Window, Screw On	#12606	\$33.95
55-57	4-Door Wgn	Upper Quarter Window, Screw On	#12607	\$24.95
55-57	All	Upper Liftgate, Screw On	#12608	\$17.95
55-57	2-Door Sed/Wgn	Upper Window, 1-Door Only, Screw On	#12609	\$18.95
55-57	4-Door Sed/Wgn	Upper Window, 1-Door Only, Screw On	#12610	\$19.95
55-57	2-Door Wgn	Lower Window Quarter Mldg, Screw On	#12611	\$37.95
55-57	4-Door Wgn	Lower Window Quarter Mldg, Screw On	#12612	\$31.95
55-57	All	Lower Liftgate, Screw On	#12613	\$19.50
55-57	210, 2 & 4-Door Sedan	Lower Window, Screw On	#12614	\$17.95
55-57	210	Original Style, Push-In	#12791	\$1.95/ea.
55-57	210 2-Door Sedan	Original Style, Push-In	#12792	\$44.95
55-57	210 4-Door Sedan	Original Style, Push-In	#12793	\$48.95
55-57	210 & Bel Air 2-Door Wagon	Original Style, Push-In	#12794	\$68.95
55-57	210 & Bel Air 4-Door Wagon	Original Style, Push-In	#12795	\$95.95
55-57	210 & Bel Air 2-Door Wagon	Original Style Belt & Roof, Screw-On	#12334	\$159.95
55-57	210 & Bel Air 4-Door Wagon	Original Style Belt & Roof, Screw-On	#12335	\$210.95

2. Lenses & Lights

SECTION AT A GLANCE:

Taillights.....	62
Related	64
Third Brake Light.....	68
Headlights & Related	69-74
Reflectors	75
Parklights	76
Back-Up Lights	78
Lens Gaskets.....	79
Dome Lights.....	80
License Lights.....	81
Light Bulbs	82
Indicator Lenses.....	83
Dash Lenses.....	84

TAILLIGHTS

1955 TAILLIGHT HOUSING ASSEMBLY



Our 1955 taillight bezels and lenses have always been the best in the industry, but with the addition of the housings we can offer the complete assembly. The taillight assemblies come with everything you need to completely refresh and beautify the taillights on your project. Danchuk #15512 will work on any 1955 classic Chevy. Proudly **Made in the USA***.



1955 Complete Assembly	#15512*	\$269.95/pr.
1955 Best, Bezel Only	#153*	\$99.95/pr.
1955 Good, Bezel Only	#16737	\$69.95/pr.



1955 TAILLIGHT HOUSING



Two needed per car.

1955	#14632	\$49.95/ea.
-------------------	---------------------	--------------------

1956 LOWER TAILLIGHT CURVED J-NUTS

These install at the bottom of the taillight opening the bottom center screw goes through the bezel and screws into the clip.



1956	#16629	\$9.95/pr.
-------------------	---------------------	-------------------



1956 UNDER TAILLIGHT REFLECTORS



A perfectly detailed mould makes the brilliant red lenses and a precision stamping die does the rest, out of beautiful and indestructible stainless steel. The engraving is exact, you can't tell the difference from the originals. **Made in the USA***.

1956 Best	#499*	\$25.95/pr.
1956 Good	#16742	\$18.95/pr.

1956 TAILLIGHT REFLECTOR LED KIT

Not your standard 1956 taillight reflector. This replacement 1956 taillight reflector adds the custom touch and safety of five bright LED lamps to brighten up the rear of your classic. The LED lights are easily wired into your existing wiring harness and improve visibility without changing the original classic design.



1956	#16276	\$9.95/ea.
-------------------	---------------------	-------------------

1956 TAILLIGHT HOUSING ASSEMBLY  

We've gone over the top with this one by starting with a perfect set of originals and making all the tooling **in the United States of America**. We copied every curve and contour to make six different molds for all the castings. Then we made numerous stamping dies for the bulb sockets, gas door parts and even the original style clip that safely holds the wiring in place. After all parts look and fit together perfect, we send them out to get the best quality chrome plating money can buy. The end result is a set of taillight housings that are absolutely breath taking. We also include all mounting hardware, reflectors, seals, gaskets and a pair each of our spectacular red taillight lenses and clear back-up light lenses.

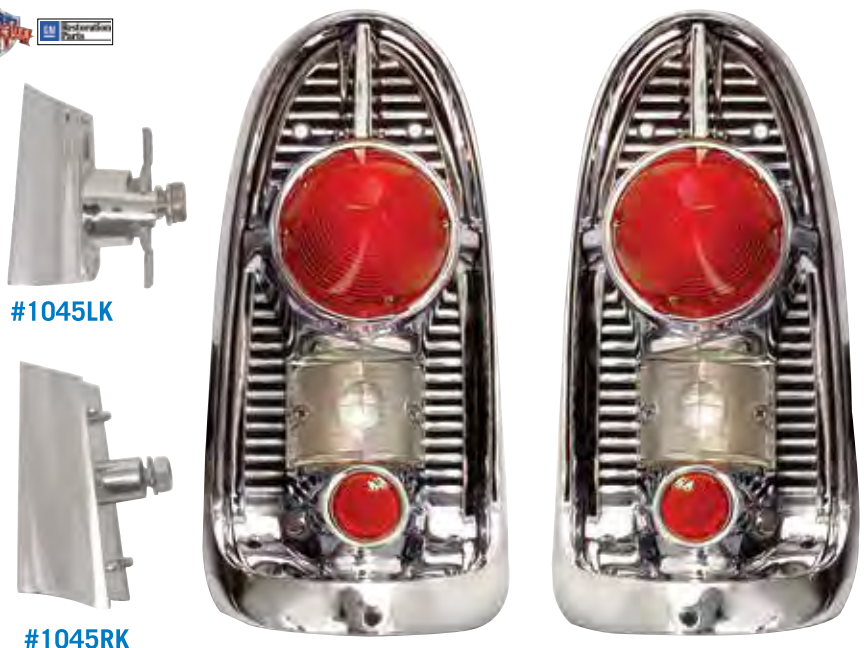

#1045LK

#1045RK

1956.....	#1045.....	\$579.95/set
1956 Taillight Mounting Kit.....	#1045A.....	\$10.95/kit
1956 Taillight Housing Wire Clip.....	#1045B.....	\$2.95/ea.
1956 Taillight Knob, Driver	 #1045LK.....	\$49.95/ea.
1956 Taillight Knob, Passenger.....	#1045RK.....	\$29.95/ea.



1957 TAILLIGHT HOUSING ASSEMBLY  

Since 1957 these beautiful taillights have brilliantly lit up the rear of our classics. And we couldn't be happier with the results of our American made tooling on these show stopping pieces. They fit exactly like originals and do we dare say, look better? We put hours into hand working each casting before the chrome process even begins. After each casting is prepped then we put the best show quality chrome money can buy and then finish them off with correctly pressed in light bulb sockets, bulbs, gaskets, studs, screws, seals and the most gorgeous Danchuk made red lenses there are. **"Danchuk, There's No Comparison"**. Part #16757 is HOUSING ONLY, so light bulb sockets, bulbs, gaskets, studs, screws, seals, and lenses are not included.



1957 Best	#965*	\$469.95/set
1957 Good, Housing Only.....	#16757.....	\$299.95/pr.

 **WARNING!** Products on these pages may contain chemicals known to the State Of California to cause cancer and/or birth defects or reproductive harm. www.p65warnings.ca.gov



#487



#491A



#495

TAILLIGHT RELATED

TAILLIGHT LENSES



Our lenses are manufactured under the most stringent standards. We use the highest quality plastics, which we guarantee against fading, cracking, or warping. You'll find our lenses fit like the originals you're replacing, and they may last even longer. Gaskets and hardware not included. See right for gaskets and page 76 for screw sets. **Made in the USA.**

1955.....	#487.....	\$12.95/pr.
1956.....	#491A.....	\$12.95/pr.
1957.....	#495.....	\$12.95/pr.

Note: Our 1955 lenses do not accommodate diffusers.



#12292



#10478

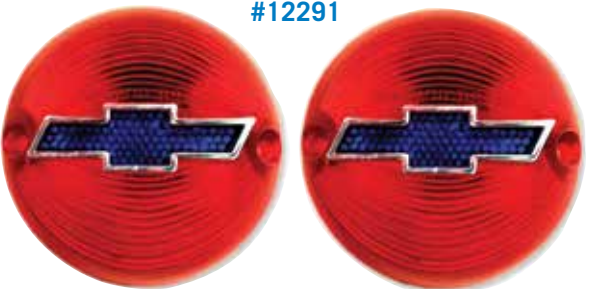

#12291



#10486

TAILLIGHT LENSES WITH BLUE DOT BOWTIE

Gaskets and hardware not included. Check local regulations before installing.

1955.....	#12290.....	\$40.95/pr.
1956.....	#12291.....	\$40.95/pr.
1957.....	#12292.....	\$40.95/pr.

TAILLIGHT LENSES WITH BOWTIE

Gaskets and hardware not included.

1955.....	#10478.....	\$34.95/pr.
1955 w/ Chrome Bowtie.....	#10479.....	\$34.95/pr.
1956.....	#10482.....	\$34.95/pr.
1956 w/ Chrome Bowtie.....	#10483.....	\$34.95/pr.
1957.....	#10486.....	\$34.95/pr.
1957 w/ Chrome Bowtie.....	#10487.....	\$34.95/pr.

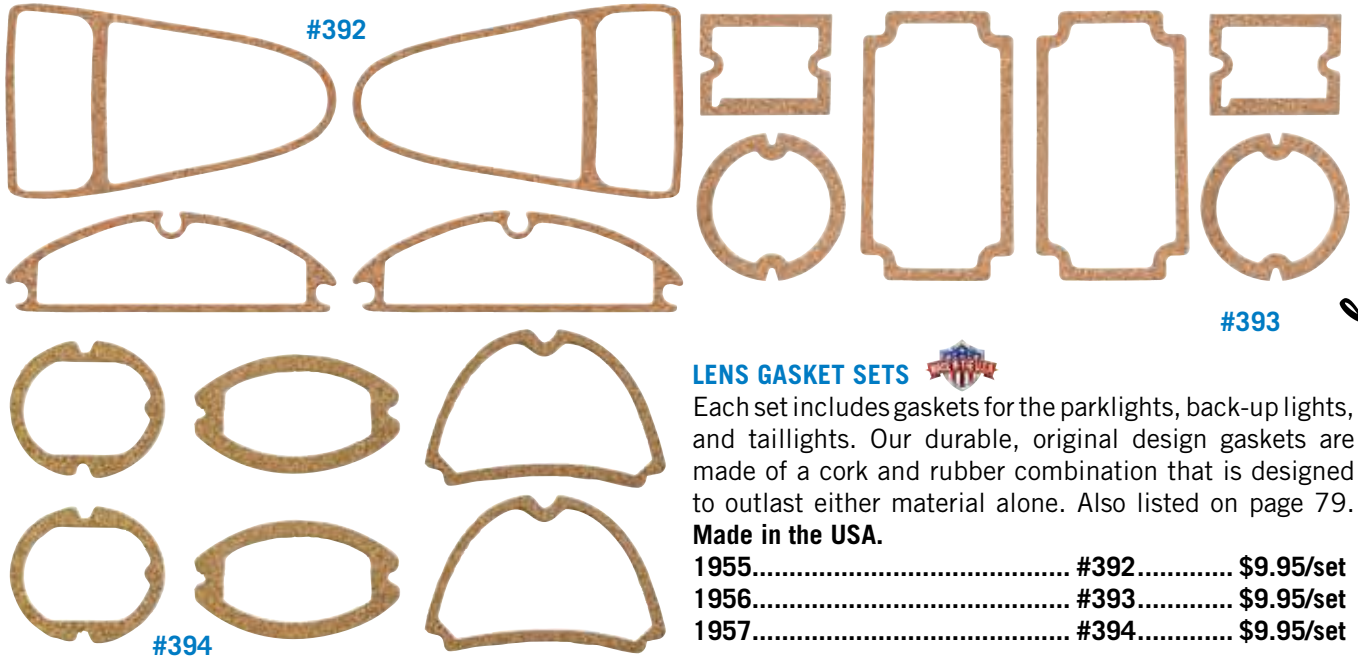

LENS GASKET SETS



Each set includes gaskets for the parklights, back-up lights, and taillights. Our durable, original design gaskets are made of a cork and rubber combination that is designed to outlast either material alone. Also listed on page 79.

Made in the USA.

1955.....	#392.....	\$9.95/set
1956.....	#393.....	\$9.95/set
1957.....	#394.....	\$9.95/set



CUSTOM TAILLIGHT LENSES

If it is the high-tech modern look your striving for with your classic Chevy, then these custom lenses are exactly what you need. Installation requires gluing the lenses to the bezels. The 1956 version will require modifying the housing to clear the lens.

1955.....	#2631.....	\$63.95/pr.
1956.....	#2632.....	\$63.95/pr.



1957 SEQUENTIAL LED TAILLIGHT LENS

These 32-LED sequential taillight lens assemblies install easily with the attached connector that plugs into your existing taillight socket. These feature fully sealed electronics and super bright LED lights that come on starting on towards the center and move to the outside until the entire taillight is illuminated. Includes a selector switch to turn the sequential function off, make the LED's light left to right or right to left. Also features a brake attention option with a sequential-once function.



1957.....	#19448.....	\$41.95/ea.
-----------	-------------	-------------





#17191



#17192

HOUSINGS NOT INCLUDED



#17193

DIGI-TAILS CONVERSION KITS

DIGI-TAILS kits are safer and brighter than standard factory lights or other LED kits because these light-panels contain high-intensity wide-angled LEDs that are strategically positioned to maximize light output and fully optimize your lenses. These are also the only fully sequential LED kits. DIGI-TAILS utilize advanced technology by lighting LED's in a fluid and sweeping pattern, rather than merely lighting up blocks of LED's. DIGI-TAILS allows you to choose standard operations or the fully sequential feature with a flip of a switch, conveniently located on every board. Due to the LED's low resistance a new electronic flasher, part #13677, is recommended. Included pigtail kits come complete with everything needed to replace your old standard bulbs with high quality LED lighting; clear instructions are included.

1955 Taillight.....	#17191.....	\$249.95/kit
1956 Taillight.....	#17192.....	\$189.95/kit
1957 Taillight.....	#17193.....	\$199.95/kit
1955 Parklight.....	#17194.....	\$115.95/kit
1956 Parklight.....	#17195.....	\$115.95/kit
1957 Parklight.....	#17196.....	\$105.95/kit
1955 Taillight, Parklight.....	#17197.....	\$329.95/kit
1956 Taillight, Parklight.....	#17198.....	\$259.95/kit
1957 Taillight, Parklight.....	#17199.....	\$249.95/kit

LED LENS ASSEMBLIES

These LED taillights and back-up lights feature fully sealed electronics and come with #1157 or #1156 plug for easy installation (except '56 version). Taillights are available in either red or clear lenses. Due to the LED's low resistance a new electronic flasher, part #13677, at right, is recommended.



#14540



LED FLASHER

This low resistance flasher will work with both LED and incandescent bulbs and is a must have when using LED light bulbs.

All Flasher, LED..... #13677 \$21.95/ea.

1955 Taillight, w/ Red Lens.....	#14540.....	\$36.95/ea.
1955 Back-Up, w/ Clear Lens.....	#14542.....	\$42.95/ea.
1956 Taillight, w/ Red Lens.....	#14543.....	\$28.95/ea.
1957 Taillight, w/ Red Lens.....	#14546.....	\$32.95/ea.



BLUE DOTS WITH BOWTIE EMBLEMS

All..... #1923..... \$19.95/pr.



TAILLIGHT LED CONVERSIONS

LED taillight conversions convert the tail, stop, and turn signals into very bright and visible LED's giving you maximum brightness for better visibility and safety. They don't run hot like traditional bulbs so your lenses last longer too. Due to the LED's low resistance a new electronic flasher, part #13677, on page 66, is recommended.

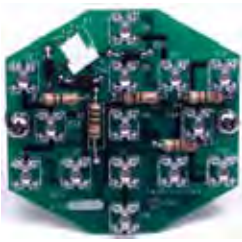

1955.....	#12293.....	\$89.95/pr.
1956.....	#12295.....	\$89.95/pr.
1957.....	#12296.....	\$89.95/pr.



1957 TAILLIGHT DUST SHIELDS

Keep the dust and gunk out with these top notch reproductions. Part #1002 comes complete and ready to use with the retainers. Part #564 is rubber only. For use with #551 back body-to-bumper seal, found on page 54.

Made in the USA.

w/ Retainers	#1002.....	\$25.95/pr.
w/o Retainers	#564.....	\$13.95/pr.



1956 UNDER TAILLIGHT GASKETS

For use with the back body-to-bumper seal, part #550, found on page 54. **Made in the USA.**

1956.....	#920.....	\$9.95/pr.
-----------	-----------	------------



TAILLIGHT HARNESS PIGTAILS

1955-56	#12246.....	\$38.95/pr.
1957.....	#12247.....	\$38.95/pr.

TAILLIGHT HARNESS PIGTAIL GROMMETS

1955-56	#12244.....	\$27.95/pr.
1957.....	#12245.....	\$27.95/pr.

1957 TAILLIGHT HOUSING-TO-BODY SEALS

These seals install between the taillight housing and body to block out moisture and dirt. Included in our part #965.



Made in the USA*.

1957 Best	#032*	\$9.95/pr.
1957 Good	#16758.....	\$3.95/pr.

1955 TAILLIGHT MOUNTING STRAPS

These stainless steel straps divide the back-up light lens from the taillight lens. **Made in the USA.**



1955.....	#073*	\$17.95/pr.
-----------	-------------	-------------

TAILLIGHT MOUNTING ASSEMBLIES

All the assorted screws and retainer clips to do the job right. Fasten those new taillight lenses, mounting straps, and bezels in place the right way. Part #16629 is included in the #1045A. **Made in the USA.**



1955.....	#1029.....	\$9.95/set
1956.....	#1045A.....	\$10.95/set
1956 Lower J-Nuts.....	#16629.....	\$9.95/pr.

WARNING! Products on these pages may contain chemicals known to the State Of California to cause cancer and/or birth defects or reproductive harm. www.p65warnings.ca.gov



#560



#560A

INNER PARKLIGHT AND TAILLIGHT HOUSING SEALS



These seals install between the parklight and taillight housings and body to block out moisture and dirt. **Made in the USA***.

1955.....	#560*	\$12.95/set
1956 Best.....	#560A*	\$12.95/set
1956 Good.....	#16778.....	\$7.95/set



TAILLIGHT AND HEADLIGHT ASSEMBLY SEALS

These install in the provided channel in the taillight and headlight bezels and seal the bezel to the fender.

Made in the USA.

1956 Taillight, '57 Headlight.....	#557.....	\$12.95/pr.
------------------------------------	-----------	-------------



LED BRAKE LIGHT ATTENTION MODULE

The LED brake light attention module rapidly flashes the third brake light or both taillights for a second or two to gain the attention of the driver behind you. Flash duration and speed are adjustable. Use only with LED taillights.

All.....	#16825.....	\$14.95/ea.
----------	-------------	-------------



#12241



#13202

TRUNK THIRD BRAKE LIGHT ASSEMBLIES

Designed to replace the rear '55 trunk emblem or the rear '57 vees, these third brake light assemblies are a stylish addition to any classic. The 55 unit comes with a beautifully chrome plated bezel that surrounds a red lens which includes a raised chrome bow-tie accent. Bright LED lights signal to those behind you that you are stopping and behind the bow-tie is an LED running light. The 57 units are available in either a gold tone or chrome with two top quality lenses back by LED lights that glow when the brake pedal is depressed. The 57 unit is designed to fit as original without mounting back piece or it can be mounted on any flat surface. Each assembly comes with complete instructions. Danchuk #12242 wiring harness required for installation.

1955 Chrome w/ Bowtie.....	#12241.....	\$234.95/ea.
1957 Gold.....	#13201.....	\$269.95/ea.
1957 Chrome.....	#13202.....	\$234.95/ea.



THIRD BRAKE LIGHT HARNESS

For use with part #13201, #13202 and #12241.

1955-57.....	#12242.....	\$25.95/ea.
--------------	-------------	-------------



BILLET BOWTIE PEDESTAL THIRD BRAKE LIGHTS

All Polished.....	#10029.....	\$87.95/ea.
All Brushed.....	#10028.....	\$74.95/ea.



#12638



#12639



#12640

HEADLIGHT BUCKETS

Manufactured according to the original Chevrolet specs from top quality steel these headlight buckets are perfect to replace your rusted originals. Sold as a pair, they come complete with the bezel clips and bulb adjusters installed. If you need sealed beam buckets, see our bucket assemblies below.

1955.....	#12638.....	\$99.95/pr.
1956.....	#12639.....	\$99.95/pr.
1957.....	#12640.....	\$99.95/pr.



#16127



#16987



HEADLIGHT BUCKET TO FENDER SEALS



These seal the rear lip of the headlight bucket to the fender to keep dirt and moisture out. **Made in the USA***.

1955-57 Best.....	#865*	\$10.95/pr.
1955-57 Good.....	#16719.....	\$5.95/pr.



HEADLIGHT BUCKET ASSEMBLIES

These come complete with the headlight bucket, sealed beam bucket, retaining ring, springs, gasket and adjuster. All you need to add is the bulb and a new bezel. Wiring is sold separately. Fits both sides. Two required per car.

1955.....	#16127.....	\$49.95/ea.
1957.....	#16987.....	\$52.95/ea.

HEADLIGHT BUCKET WIRE GROMMETS

The headlight wire runs through these grommets which are installed at the rear of the headlight bucket to protect the wire from chafing on the metal housing.



1955-56 Best (Shown).....	#835.....	\$5.95/pr.
1955-56 Good.....	#16718.....	\$3.95/pr.



HEADLIGHT BUCKET TO BODY FASTENERS

1955-57	#12337.....	\$4.50/set
---------------	-------------	------------

WARNING! Products on these pages may contain chemicals known to the State Of California to cause cancer and/or birth defects or reproductive harm. www.p65warnings.ca.gov

1955 HEADLIGHT BEZELS



Produced in Santa Ana, California by our master toolmakers these bezels are a shining example of the quality and workmanship we put into all our parts. Finished in a show quality copper-buffed chrome, these bezels fit and look exactly like GM originals. Rubber seals and hardware included in part #593. **Made in the USA***.



1955 Best #593* \$139.95/pr.
 1955 Good - Hardware not included #17684 \$79.95/pr.

1956 HEADLIGHT BEZELS



Just like our 1955 versions, these are produced in Santa Ana, California by our master toolmakers these bezels are a shining example of the quality and workmanship we put into all our parts. Finished in a show quality copper-buffed chrome, these bezels fit and look exactly like GM originals. Rubber seals and hardware included in part #1057. **Made in the USA***.



1956 Best #1057* \$129.95/pr.
 1956 Good - Hardware not included #17685 \$99.95/pr.

1957 HEADLIGHT BEZEL ASSEMBLIES



Danchuk's '57 bezels are far superior to any other bezels on the market. Our attention to detail shows in the highly polished surfaces, black painted air intakes and beautiful show quality chrome plating. Rubber seals and mounting hardware included in part #877. **Made in the USA***.



1957 Best #877* \$269.95/pr.
 1957 Good - Hardware not included #17686 \$196.95/pr.



STAINLESS HEADLIGHT RETAINING RINGS



These rings are a beautiful final touch to top off the sparkle of your front end. These exact reproductions are made by Danchuk from top quality stainless steel correctly formed to original specifications.

1955 #16030 \$22.95/ea.
 1956-57 (Shown) #14222 \$22.95/ea.



1957 HEADLIGHT BEZEL INSERT DECALS 

For that clean, crisp look, detail your headlight bezels with our decals. One sheet of die-cut vinyl decals will detail both headlight housings. They are faster and easier to apply than paint. Matte black finish. **Made in the USA.**

1957..... #333..... \$10.95/set



REPLACEMENT SEALED BEAM HEADLIGHT

This is a replacement sealed beam headlight that installs without modifications. 7-inch high/low design.

1955-57 #128..... \$11.95/ea.



HEADLIGHT BEZEL SEALS 

We make these seals with the wire cores so they look and install exactly like they did when GM installed them originally. **Made in the USA.**

1955-56 #864..... \$10.95/pr.



HEADLIGHT BEZEL SCREW SETS 

Whether you're replacing the headlight bezels or just detailing the front end, installing new mounting hardware is the best way to get the glimmering results you want. One set per car required. **Made in the USA.**

1955..... #1743..... \$2.95/set
 1956..... #1744..... \$2.95/set
 1957..... #1745..... \$2.95/set



HEADLIGHT ADJUSTMENT SCREW SETS 

Each headlight requires two screws, one for vertical adjustment and one for horizontal. One set required per car.

1955-57 #1154..... \$2.95/set
 1955-57 #12233* \$16.95/set

*Note: Comes with nylon insert.

HEADLIGHT ADJUSTMENT SPRING



The headlight adjustment spring provides the tension necessary to properly adjust the headlight and keep it from moving. Two required per car.

1955-57 #1155..... \$2.95/ea.

HEADLIGHT LEGEND:

- DOT** Dept. of Transportation Approved
- EURO** Euro Style "Flat" Lens
- CLASSIC** OE Style Round Lens
- LED** Light Emitting Diode
- HID** High Intensity Discharge
- DRL** Daytime Running Light
- H4** Bulb Plug Type
- COB** Chip On Board (Type of LED)
- SMD** Surface Mount Diode (Type of LED)
- XENON** Halogen Bulb Enhanced with Xenon Gas

MORE HEADLIGHTS AVAILABLE ON NEXT PAGE

DELTA
DELTA 7" HALO HEADLIGHTS

These Delta Halo Headlights; DOT and Classic series are now available in Halo configuration. This 7.5 watt COB LED Angel Eye halo provides an element of safety as a DRL light as well as a stylish trend setting look to your classic vehicle, hot rod to present. Installation is as easy as a bulb replacement with one additional step of running your Halo power lead to your ignition fuse or other 12V ignition source. **Made in the USA.**

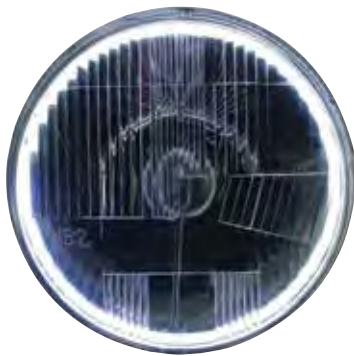

- All DOT w/ Euro, LED (Shown) #18357 \$459.95/pr.
- All Classic LED #18359 \$459.95/pr.
- All DOT w/ Euro, Xenon..... #18358 \$259.95/pr.
- All Classic Xenon #18360 \$259.95/pr.

CITY LIGHTS HEADLIGHTS WIRE HARNESS

This harness makes it easy for you to wire your Delta headlights by utilizing the "City Light" feature for daytime runner, parklight or turn signal options.

- 1955-57 #14831 \$49.95/ea.



#17021



#17019

#14578



#17787

DELTA LED 7" HEADLIGHT KITS



7-inch LED Classic Series replacement for 2-Headlight System on Classic Cars and Hot Rods. Replaces 6014/H6024 Type High/Low beam. Powerful LED CREE® Technology combined with Delta Tech's Prismatic lens and flawless parabola delivers unmatched power, clarity and near daylight illumination at 1900 Lumen at both high and low beam, while drawing only two amps per light. This performance comes with expected life of 25,000 hours or 22 years. Assembled in the USA.

- All Classic..... #17785 \$369.95/kit
- All Classic w/ City Lights Kit..... #17786 \$389.95/kit
- All DOT..... #17787 \$379.95/kit
- All DOT w/ City Light Kit..... #17788 \$385.95/kit

DELTA

DELTA XENON AND H.I.D. HEADLIGHTS



Delta H4 and H.I.D. headlights are a direct replacement for your stock sealed beam lights and re-use the original mounting hardware and connectors. Delta headlights are available in bright white Xenon or High Intensity Discharge (H.I.D.). Lenses are available in two styles; classic curved lenses like the originals, or Euro that have a flat European style lens with a built-in city light that can be wired as a park/turn light or daytime runner. Note: to install Delta or H4 headlights minor trimming to sealed beam bucket is necessary. We recommend that when installing H4 type headlights that a relay kit such as #16826 be installed for better performance and to reduce the load on the headlight switch. H.I.D. headlights may not be DOT compliant, please check your local regulations for approval.

- 1955-57 7" Classic w/ Xenon Bulbs..#14646 ..\$139.95/kit
- 1955-57 7" Classic w/ HID Bulb#14577 ..\$287.95/kit
- 1955-57 7" Euro w/ Xenon Bulbs.....#14829 ..\$128.95/pr.
- 1955-57 7" Euro w/ Xenon Bulbs and City Lights
#14647 ..\$138.95/pr.
- 1955-57 7" Euro Hi/Lo H.I.D. w/ City Lights
#14830 ..\$399.95/kit
- 1955-57 7" Classic Hi/Lo Xenon w/ City Lights
#17019 ..\$138.95/pr.
- 1955-57 7" Classic Hi/Lo H.I.D. w/ City Lights
#17020 ..\$379.95/kit
- 1955-57 7" Euro Hi/Lo H.I.D.....#17021 ..\$342.95/kit
- All H4 Xenon Replacement Bulb, 60/55 Watt
#14578\$25.95/pr.



#19396



#19397

DAPPER LIGHTING OE7 LED HEADLIGHTS

The Dapper Lighting OE7 has their LED projector technology in a package that looks original, but with a clear lens. They deliver 3X more light than a traditional H4 conversions and they draw 65% less power than a sealed beam. Their patent pending Active Cooling System provides up to 30% cooler LED operating temperatures than other brands so your LED's will last longer. The OE7 also features Progressive Low/High output to aid your eyes when driving at night. When you turn on your hi-beams, your low beams dim so your eyes can adjust to seeing light further down the road and studies show the foreground light should be decreased to increase distance visibility.

- 1955-57 Clear Lens..... #19396..... \$299.95/pr.
- 1955-57 OE Lens..... #19397..... \$349.95/pr.



#19302



#19060



#17024



H4 HALOGEN LED HEADLIGHTS WITH WHITE HALO

These are 7-inch halogen replacement headlights with a white LED halo around the outer rim of the bulb. The COB and SMD halo rings are much brighter than the standard LED halos and can easily be seen during the day or night even with the headlights on. Minor trimming of light bucket is required on #17024.

- 1955-57 Crystal w/ White Standard Halo..... #17024..... \$49.95/pr.
- 1955-57 OE Style w/ White SMD Halo..... #19060..... \$99.95/pr.
- 1955-57 OE Style w/ White COB Halo..... #19302..... \$99.95/pr.



LED HALO HALOGEN HEADLIGHTS WITH SWITCHBACKS

Upgrade your headlights with these crystal reflector halogen headlights with Switchback LED Halos. The Switchback LED allows you to wire it as a DRL that turns from white to amber when signaling. Additional Halo wiring is required.

- All White DRL/Amber..... #19170..... \$149.95/pr.

CRYSTAL HEADLIGHT BULB WITH 10 AMBER LED AUX LIGHT

These 7-inch headlights feature a multi faceted aluminum reflector (not plastic like some others) and crystal glass lens and meets DOT/SAE Standards. The 10 Amber LEDs have many uses and can be wired for turn signal, DLR's, parklights, etc. Be sure to order part #16826 relay kit for best performance. Minor trimming of light bucket is required.



- All..... #16824..... \$41.95/ea.



STANDARD



SMD



COB



OE STYLE H4 HALOGEN HEADLIGHTS

- All OE Style..... #18864..... \$45.95/pr.

WARNING! Products on these pages may contain chemicals known to the State Of California to cause cancer and/or birth defects or reproductive harm. www.p65warnings.ca.gov



HALOGEN HEADLIGHTS WITH LED HALO

These Halo headlights feature SMD LED in white or multi-colored and use an H4 halogen bulb that produces a brighter light than OE. The Halo lights can be wired as a daytime running light.

HEADLIGHT RELATED

On part #17941, the wireless remote allows you to change the color of the LED ring of the headlight on the fly. With 16 colors to choose from you can have a different look every day. Kit includes two headlamp assemblies with a multi-color LED ring, two removeable H4 bulbs, dust boots, RGB harness, ceramic pigtail and a wireless remote.

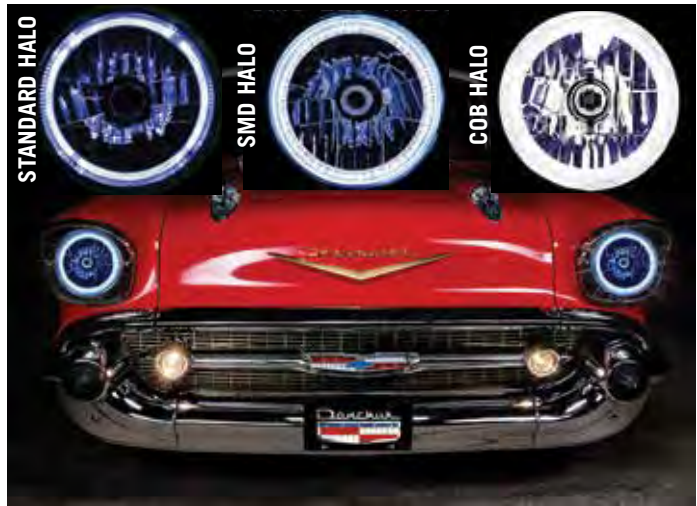

All SMD, White	#17940.....	\$99.95/pr.
All SMD, Multi-Color, w/ Remote, 7"	#17941.....	\$159.95/kit
All COB, White, 7"	#18997.....	\$119.95/pr.
All COB, Multi-Color, 7"	#18998.....	\$189.95/ea.

2-Headlight Relay Harness

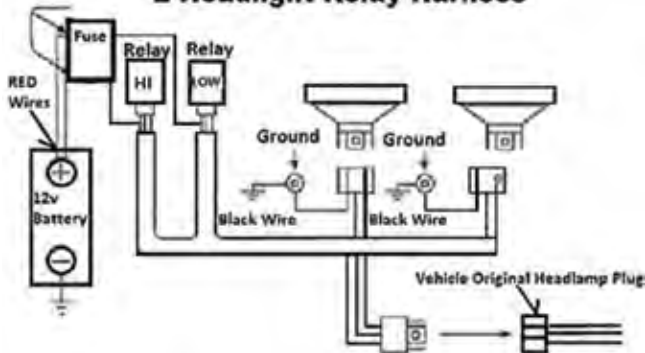

1. Plug in and install headlamp.
2. Ground both black wires from headlamp plugs.
3. Attach single red wire to Positive battery.
Single red wire now powers both relays.
4. Plug harness to original vehicle headlamp plug.



H4 HEADLIGHT RELAY HARNESS

Installing the latest H4 or other headlight technology in your classic? Want to get the most out of your stock OE or aftermarket headlights? This relay kit allows maximum voltage to the headlights and takes the load off of the headlight switch making it run cooler and last longer. Headlight relay kits are HIGHLY recommended when installing high performance headlights, such as H4 and other halogen bulb types. With the extra current draw that aftermarket halogen headlights put on the stock headlight switch, the safety circuit can sometimes trip. Works with bulbs with OE style terminals. Not required when using H.I.D. or LED lights.

All.....	#16826.....	\$34.95/ea.
----------	-------------	-------------



HEADLIGHT SWITCHES

Without these your headlights and dash lights will be dark. Our #117A is an exact reproduction of the GM original with the built in fuse. So, if your original is giving you trouble, we have the switch for you. Also listed in Switches section on page 274. We highly recommend replacing the retaining nut as well.

1955-56, '55-59 Truck, '55-57 Vette	
..... #117A.....	\$39.95/ea.
1957-63	#117.....\$29.95/ea.



1955-56 HEADLIGHT SWITCH RETAINING NUT

1955-56 Stainless
..... #13845.\$19.95/ea.



1957 HEADLIGHT SWITCH RETAINING NUT

1957 w/ Nylon Insert
..... #11206.\$12.95/ea.



CLASSIC UPDATE REPLACEMENT HEADLIGHT SWITCH WITH CONNECTOR

Replacement switch for cars using the American Autowire Classic Update series wiring kits.

1955-57



CLASSIC UPDATE REPLACEMENT HEADLIGHT SWITCH RETAINING NUT

Replacement retaining nut for the headlight switch on cars using the American Autowire Classic Update series wiring kit.

1955-56



GLASS DOTS . . . JUST LIKE BACK IN THE 50'S!

All Blue, Smooth, 15/16".....	#15993.....	\$13.95/pr.
All Red, Smooth, 15/16".....	#15994.....	\$13.95/pr.
All Amber, Smooth, 15/16"	#15995.....	\$13.95/pr.
All Clear, Smooth, 15/16".....	#15996.....	\$13.95/pr.
All Rainbow, Smooth, 15/16".....	#15997.....	\$13.95/pr.
All Green, Smooth, 15/16".....	#15998.....	\$13.95/pr.
All Blue, Faceted, 15/16"	#15999.....	\$13.95/pr.
All Red, Faceted, 15/16"	#16000.....	\$13.95/pr.
All Amber, Faceted, 15/16".....	#16001.....	\$13.95/pr.
All Clear, Faceted, 15/16".....	#16002.....	\$13.95/pr.
All Rainbow, Faceted, 15/16"	#16003.....	\$13.95/pr.
All Green, Faceted, 15/16"	#16004.....	\$13.95/pr.
All Yellow, Faceted, 15/16"	#16005.....	\$13.95/pr.



GLASS REFLECTORS

All Dark Blue, Smooth, 15/16".....	#16006.....	\$16.95/pr.
All Light Blue, Smooth, 15/16".....	#16007.....	\$16.95/pr.
All Red, Smooth, 15/16".....	#16008.....	\$16.95/pr.
All Amber, Smooth, 15/16"	#16009.....	\$16.95/pr.
All Clear, Smooth, 15/16".....	#16010.....	\$16.95/pr.
All Rainbow, Smooth, 15/16".....	#16011.....	\$16.95/pr.
All Green, Smooth, 15/16".....	#16012.....	\$16.95/pr.
All Blue, Faceted, 15/16"	#16013.....	\$16.95/pr.
All Red, Faceted, 15/16"	#16014.....	\$16.95/pr.
All Clear, Faceted, 15/16"	#16015.....	\$16.95/pr.
All Rainbow, Faceted, 15/16"	#16016.....	\$16.95/pr.
All Green, Faceted, 15/16"	#16017.....	\$16.95/pr.
All Yellow, Faceted, 15/16"	#16018.....	\$16.95/pr.



COMPLETE 1956 PARKLIGHT HOUSING ASSEMBLY



Just another example of our attention to detail. The 1956 parklight backing plates

are a series of complex contours stamped out of the finest steel. The parklight housings are cast from molds produced by our master toolmakers in Santa Ana, California. We hand work the castings until they are perfect and then both the backing plates and housings are treated to the finest show quality chrome plating you can get. **Made in the USA***.

PARKLIGHTS

1956 Best, Housing Assembly Only.....	#1080A*	\$199.95/set
1956 Good, Housing Assembly Only.....	#17687	\$145.95/set
1956 Backing Plates Only, Best.....	#1081*	\$169.95/pr.
1956 Backing Plates Only, Good.....	#16723	\$109.95/pr.
1956 Housings & Backing Plates	#15017*	\$359.95/set



1955 PARKLIGHT HOUSING ASSEMBLIES



It's parts like these that we built our reputation on. These housings are absolutely gorgeous, featuring show quality chrome plating, correctly pressed in light bulb housings, new lenses, sockets and cables, light bulbs, gaskets and mounting hardware and most importantly **Made in the USA.**

1955.....	#533.....	\$179.95/set
-----------	-----------	--------------



1957 PARKLIGHT HOUSINGS

Whether you've replaced your grille bar, or just want to brighten up your parklights, our reproduction housings are the way to go. Brilliant plating reflects more light from inside the parklight housing. You'll find installation easy, and connection into the wiring harness a snap. Get a pair of lenses and light bulbs while you're at it, you'll be amazed at the brilliance!

1957.....	#2357.....	\$29.95/pr.
-----------	------------	-------------



Photo courtesy of GERTMAN2000



PARKLIGHT, TAILLIGHT AND BACK-UP LENS SCREW SETS

Highlight your new lenses with new assembly hardware. These screws are stainless and won't rust or corrode, and can be polished to a mirror finish. 1957 kit does not include the back-up lens screws. **Made in the USA.**

1955.....	#1908.....	\$5.95/set
1956.....	#1909.....	\$5.95/set
1957.....	#1060.....	\$5.95/set

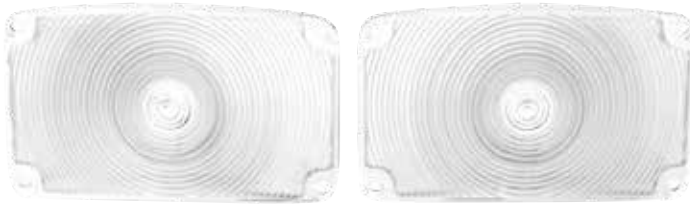

#490

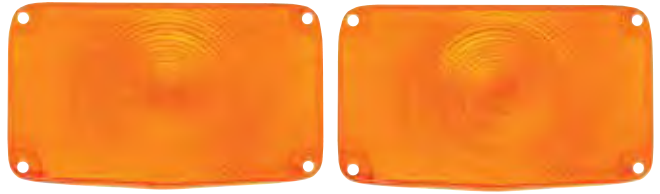

#486A



#486

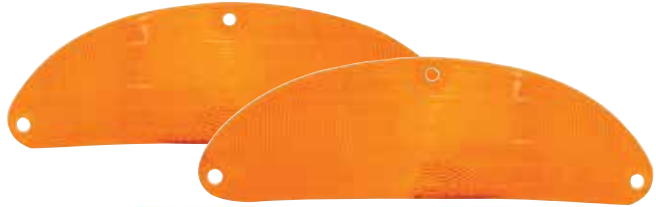

#494A



#494



PARKLIGHT LENSES



We produce all of our lenses in-house for the highest quality control. Our plastic part production was founded on the 1957 lens, and that success led to the 1955 and 1956 lenses. We feel proud of the beautifully polished, mirror-like surfaces found on our entire line of plastic parts, faithfully reproduced since 1977. Gaskets and hardware not included. See page 79 for gaskets and page 76 for screw sets. **Made in the USA.**

1955 Clear.....	#486.....	\$12.95/pr.
1955 Amber	#486A.....	\$12.95/pr.
1956 Clear.....	#490.....	\$12.95/pr.
1956 Amber	#490A.....	\$12.95/pr.
1957 Clear.....	#494.....	\$12.95/pr.
1957 Amber	#494A.....	\$12.95/pr.



LED PARKLIGHT CONVERSIONS

Update your lights with this easy to install LED conversion. Features super bright LED's with polycarbonate lens. Electronics are fully sealed against the elements and comes with 1157 style plug for easy hook-up. Don't forget the electronic flasher #13677 for proper operation. See page 79 for gaskets, page 76 for screw sets and page 66 for flasher. **Note: Modification to lens needed for the 1955 versions.**

1955 Amber w/ Clear Lens	#15564.....	\$37.95/ea.
1955 Amber w/ Amber Lens.....	#15565	\$37.95/ea.
1956 Amber w/ Clear Lens	#15566.....	\$41.95/ea.

PARKLIGHT LENSES WITH BOWTIE

Gaskets and hardware not included. See page 79 for gaskets and page 76 for screw sets.

1955 Clear.....	#10470.....	\$34.95/pr.
1955 Amber	#10471	\$34.95/pr.
1955 Amber w/ Chrome.....	#10472.....	\$34.95/pr.
1955 Clear w/ Chrome	#10477	\$34.95/pr.
1956 Clear.....	#10473.....	\$34.95/pr.
1956 Amber	#10474.....	\$34.95/pr.
1956 Amber w/ Chrome.....	#10480.....	\$34.95/pr.
1956 Clear w/ Chrome	#10481	\$34.95/pr.
1957 Clear.....	#10475.....	\$34.95/pr.
1957 Amber	#10476.....	\$34.95/pr.
1957 Amber w/ Chrome.....	#10484.....	\$34.95/pr.
1957 Clear w/ Chrome	#10485.....	\$34.95/pr.



WARNING! Products on these pages may contain chemicals known to the State Of California to cause cancer and/or birth defects or reproductive harm. www.p65warnings.ca.gov



#483

BACK-UP LIGHT LENSES



Our lenses are real show-stoppers! These intricate lenses require attention to detail to retain the same quality of the originals that can only be found on Danchuk reproductions. The 1957 lens is cast in glass, just like they were made by Chevrolet. The complete 1957 back-up light assembly, part #310, can be found on page 79. Gaskets and hardware not included. See page 79 for gaskets and page 76 for screw sets. **Made in the USA.**

1955	#483.....	\$12.95/pr.
1955 Red, Custom	#483B.....	\$18.95/pr.
1956.....	#488.....	\$12.95/pr.
1956 Red, Custom	#488B.....	\$18.95/pr.
1957 Glass.....	#492.....	\$20.95/pr.



#488



#492



BACK-UP LIGHT STAINLESS CONVERSION PLATES



Because back-up lights were optional in 1955 and 1956, many cars today still don't have this necessary feature. Along with the back-up light conversion plates, you'll need one wiring harness, found on page 251; two bulbs, found on page 82 and a neutral safety switch, found on page 276. Our back-up light conversion plates are made of durable stainless steel and sold in pairs. **Made in the USA.**

1955-56	#1875.....	\$16.95/pr.
---------------	------------	-------------



BACK-UP LIGHT SWITCH

For standard transmission. 1957's have a different bolt-on arrangement.

1955-56	#12149.....	\$26.95/ea.
---------------	-------------	-------------



1957 BACK-UP LIGHT COVER RETAINER BRACKETS

For use with part #219, shown at left, below. Includes mounting hardware.

1957.....	#979.....	\$9.95/pr.
-----------	-----------	------------



1957 BACK-UP LIGHT COVER

For those cars without the accessory back-up light assembly. Two per car. Retainer bracket shown at right.

1957.....	#219.....	\$36.95/ea.
-----------	-----------	-------------

1955 BACK-UP LENS RETAINING CLIP



Installs at the bottom of the back-up light lens and holds the lens to the taillight housing. Two required per car. For back-up lens screws sets, please see page 76. **Made in the USA.**



1955.....	#2177.....	\$3.95/ea.
-----------	------------	------------



1957 BACK-UP LIGHT ASSEMBLY 

We manufactured this unit with two things in mind. One, to duplicate the original exactly. Two, to uphold the superb workmanship you are so used to. Yes, a picture is worth a thousand words, but you'll still have to see the quality of these parts to believe it! Wiring kit #406 is included.
Note: You will also need a neutral safety switch or back-up light switch. Switches found on pages 275-276.
 1957..... #310..... \$169.95/set

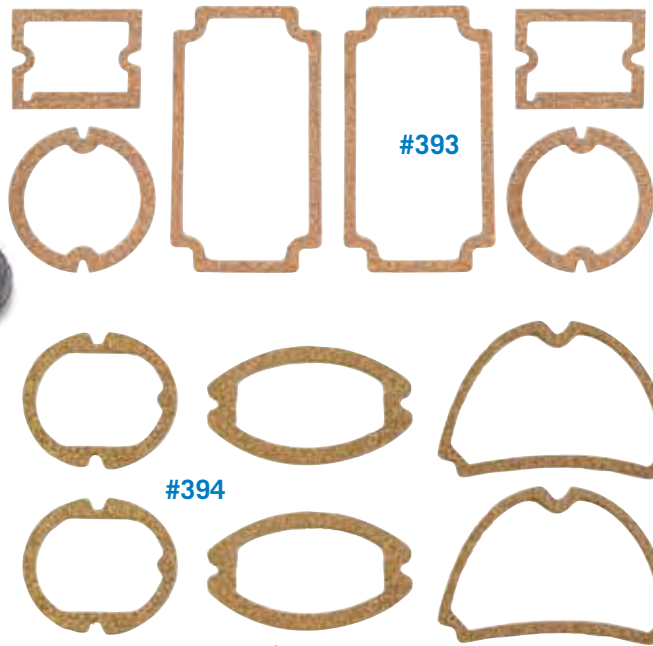

LENS GASKET SETS 

Each set includes gaskets for the parklights, back-up lights, and taillights. Our durable, original design gaskets are made of a cork and rubber combination that is designed to outlast either material alone. **Made in the USA.**

1955.....	#392.....	\$9.95/set
1956.....	#393.....	\$9.95/set
1957.....	#394.....	\$9.95/set



1957 BACK-UP LIGHT COVER WITH RETAINERS AND SCREWS

1957..... #17415..... \$69.95/pr.



1957 TRUNK LIGHT ASSEMBLY

1957..... #18161..... \$34.95/ea.



1957 LED BACK-UP LIGHT LENS

1957 with 1156 Plug..... #18975..... \$34.95/ea.



REPLACEMENT TRUNK AND UNDERHOOD LIGHT KIT

All..... #12349..... \$28.95/ea.

1955-57 SEDAN & WAGON, 1956-57 HARDTOP



DOME LIGHT HOUSING

Use with lens #212 and bezel #212A.

1955-57 and also 58-60 Sedan & Wagon
..... #12525..... \$28.95/set

DOME LENS

The heat of the dome light will yellow almost any plastic, and eventually wears the old lens out. The ideal solution is this dome lens, correctly reproduced to fit.



1955-57..... #212..... \$10.95/ea.

DOME LENS BEZEL

Beautifully plated in brilliant chrome, this bezel uses a #212 lens, shown above. One bezel required per car.



1955-57 #212A..... \$15.95/ea.

LED DOME LIGHT ASSEMBLY

Not just a conversion kit, but the entire dome light assembly. Includes housing, bezel and lens with LED circuit board installed.



1955-57..... #16819..... \$69.95/ea.

LED DOME LIGHT HOUSING CONVERSION

Try these high efficiency dome lights that use 90% less power than ordinary lights, are two to three times brighter than the old standard and don't heat up. Plugs directly into the dome light housing, #12525.



1955-57 and also 58-60 Sedan & Wagon
..... #14973..... \$34.95/ea.

1955-57 NOMAD, 1955 HARDTOP

DOME LIGHT HOUSING AND LENS

Another rare and beautiful reproduction from Danchuk. We created all new tooling from the ground up to produce this exquisite piece. Each includes the bezel, socket and lens. Two required per car.



1955-57..... #214..... \$35.95/ea.

DOME LENS

Only high-quality plastic and original design molds are used to produce this rare lens. Specialty items like this are what made Danchuk Manufacturing the industry leader. Two per car. **Made in the USA.**



1955-57 #213..... \$9.95/ea.

1955-57 NOMAD

NOMAD CARGO AREA LIGHT SWITCH WITH BEZEL

Tired of not being able to see when you open the gate on your Nomad? This complete cargo area dome light switch assembly will cure the problem. Comes complete with the switch, bezel and mounting screws so you can easily mount it in your cargo area.



1955-57..... #16234..... \$36.95/ea.

DOME LIGHT SWITCH COVER

This is for the manual dome light switch that is located in the cargo area on Nomads.



1955-57 Rear, Nomad #12619..... \$7.95/ea.

DOME LIGHT LENS HARNESS GROMMET

This harness grommet installs in the upper trunk wall over the passenger side wheel well. It serves to keep the wires from chafing on the metal and possibly causing a short.



1955-57 Hardtop..... #811..... \$5.95/ea.

CHROME ELLIPTICAL DOME LIGHT ASSEMBLY

Measures 4.5 inches by 2 inches by .75 inches.



All w/ Lens #18812..... \$69.95/ea.



LICENSE LIGHT HOUSING ASSEMBLIES

Our complete assembly includes a pair of lenses, gaskets, housings, bulbs, and wiring, ready to install. License bezels for Nomad and wagon shown below. Must drill out housing threads on wagon applications.

- 1955 All Models; '56-57 Wagon, Nomad & Sedan Delivery #485B..... \$46.95/set
- 1956 Hardtop, Sedan & Convertible (Shown) #485C..... \$46.95/set



1957 LICENSE PLATE LIGHT ASSEMBLY

Our 1957 license light assembly is true to the GM original in every way. The lenses are painted correctly, like original, and the light bulb socket is wedged in place, just like the original. The only difference is that the housing has the same show quality chrome job that we put on all our chrome parts. Will not work on Nomad, wagon or sedan delivery. **Made in the USA.**

- 1957 Hardtop, Sedan & Convertible #500..... \$62.95/set



#485

LICENSE LIGHT LENSES

We included all the original markings in our mould designs, making these lenses virtually indistinguishable from original production parts. All lenses are injection moulded in crystal clear plastic. Our 1957 lens includes an original design rubber/cork gasket made of the highest quality materials. Hardware not included. **Made in the USA.**

#493

- 1955-56 All, 1957 Nomad, Wagon, Sedan Delivery, Clear #485..... \$9.95/pr.
- 1957 Hardtop, Sedan & Convertible, Clear #493..... \$12.95/ea.
- 1957 Hardtop, Sedan & Convertible, Amber #493A..... \$12.95/ea.



LICENSE LENS BEZELS

These beautiful chrome bezels are for use with all Nomads and wagons. **Made in the USA.**

- 1955-57 #231..... \$32.95/pr.



LICENSE LIGHT WIRE GROMMETS

- 1957 #1738..... \$5.95/pr.

LICENSE LENS GASKETS

This rubber gasket seals moisture and dirt out of the license light, and should be replaced whenever the license lens is removed. The license lens wire grommet, part #1193, shown at right, is also necessary to completely seal out moisture and dirt.



- 1955 All Models; 1956-57 Wagon, Nomad & Sedan Delivery #866..... \$8.95/pr.
- 1956 Passenger Models #866A..... \$6.95/pr.



1957 LICENSE LIGHT HOUSING SCREW SET

Set includes two screws with their correct retainer clips. **Made in the USA.**

- 1957.... #680..... \$3.50/set



HIGH POWER LED LIGHT BULBS

These high-powered bulbs give you 360 degrees illumination and are brighter and cooler than standard incandescent bulbs. Lenses are white and color only appears when illuminated.

- All 1156, White #19159..... \$10.95/ea.
- All 1157, White #19160..... \$10.95/ea.
- All 1157, Red #19161..... \$10.95/ea.
- All 1157, Amber #19162..... \$10.95/ea.



SMED LED LIGHT BULBS

- All 1156, White #19163..... \$14.95/pr.
- All 1157, White #19164..... \$14.95/pr.
- All 1157, Red #19165..... \$14.95/pr.
- All 1157, Amber #19166..... \$14.95/pr.



LED LIGHT BULB

- All White, 1156, Back-Up Light #12358..... \$23.95/ea.

LIGHT BULB COVERS

AutoMeter's light bulb covers slip over your gauge's light bulb. These covers allow you to change the color of your backlighting.



- All Blue, 3-Piece Set..... #18085..... \$9.95/set



- #18087
- #18088
- #18089
- #18090

T3 WEDGE LED BULBS

Upgrade your standard instrument lighting with intense LEDs. Replaces 161, 193, 194 and 168 style wedge base bulbs only. For all AutoMeter gauges (except clocks, Air/Fuel and Autogage), speedometers, and most in-dash tachometers. Does not work with digital and LED lit gauges.

- All Red #18087..... \$14.95/ea.
- All Green #18088..... \$16.95/ea.
- All Blue #18089..... \$16.95/ea.
- All White #18090..... \$14.95/ea.

- #122
- #123
- #124
- #125
- #126
- #127
- #127A



LIGHT BULBS

We offer the whole family of light bulbs for the 1955-57 Chevy. Don't procrastinate replacing that burned-out bulb!

- 1955-57 Parklight & Taillight (1157) #122..... \$0.95/ea.
- 1955-57 Dome exc. '55 Hardtop, '55-57 Nomad (1104) #123..... \$0.95/ea.
- 1955-57 '55 Sport Coupe & '55-57 Nom - Rear Quarter (90) #124..... \$0.95/ea.
- 1955-57 License, Parklight (w/o Directional Flash), 1955-56 Clock (67) #125..... \$0.95/ea.
- 1955-57 Dash Lights: Turn Signal, Hi Beam, Ignition (53) #126..... \$0.95/ea.
- 1955-57 Instrument Cluster, Oil Press, Gen, Glove Box, Heater Panel; '55-56 - Radio Dial; '55-56 PG Indicator, '57 Clock (57)..... #127..... \$1.15/ea.
- 1955-57 Back-Up Lights (1156)... #127A..... \$0.95/ea.



#929

#10248

#930

#1059

#10469

TRANSMISSION INDICATOR LENSES

These lenses indicate the correct shifting sequence for original powerglides or automatic transmissions that have been updated. All lenses are printed in the correct colors. **Made in the USA***.

- 1955-56 TH350-400 #929..... \$17.95/ea.
- 1955-56 Powerglide (Stock) #298C* \$14.95/ea.
- 1955-56 700-R4/200-4R #10248..... \$27.95/ea.
- 1957 TH350-400 #930* \$18.95/ea.
- 1957 Powerglide (Stock) #1059* \$16.95/ea.
- 1957 700R4/200-4R #10469..... \$24.95/ea.

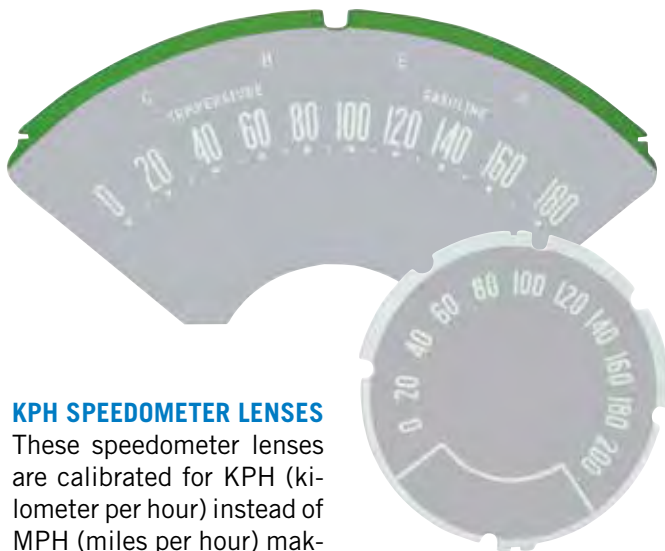

KPH SPEEDOMETER LENSES

These speedometer lenses are calibrated for KPH (kilometer per hour) instead of MPH (miles per hour) making it perfect for anyone restoring one of these cars outside of the U.S. Part #18940 will not work on any right hand drive cars. Please note all lenses are clear, but grayed to show details in photo. **Made in the USA.**

- 1955-56 #18939..... \$23.95/ea.
- 1957..... #18940..... \$23.95/ea.



#13236

COLUMN MOUNTED SHIFT INDICATOR LENSES

- 1955-57 w/ Aluminum Housing, 700-R4/200-4R Overdrive #13236..... \$89.95/ea.
- 1955-57 w/ Aluminum Housing, TH350-400 #13237..... \$89.95/ea.



#609B

#609A

1957 DASH INDICATOR LENSES AND COLOR INSERTS

If your "OIL" and "GEN" lenses have yellowed or cracked, these lenses are for you. Part #609B includes clear oil and generator lenses with black printed letters, two injection moulded red, and two injection moulded green inserts. For an inexpensive way to bring the color back to your faded inserts, order part #609A, our 1957 red and green color inserts.

- 1957..... #609B..... \$14.95/set
- 1957 Color Inserts Only #609A..... \$3.50/set

SHIFT INDICATOR SPRING BRACKET

The shift indicator spring bracket mounts around the shift tube and the column and connects the indicator wire rod to the shift indicator in the cluster.

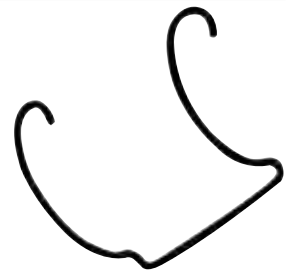

- 1955-56 #18596..... \$8.95/ea.



AUTO TRANSMISSION INDICATOR RETURN SPRING

This is the spring that keeps the shift indicator pointer moving back in place. Installs opposite the shift indicator wire rod on the shift indicator.

- 1955-56 #18163..... \$1.95/ea.

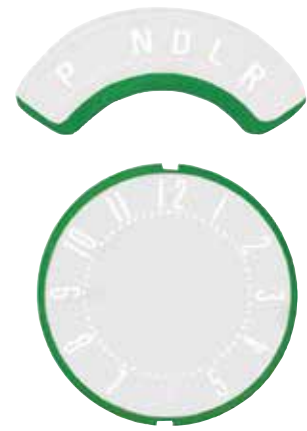
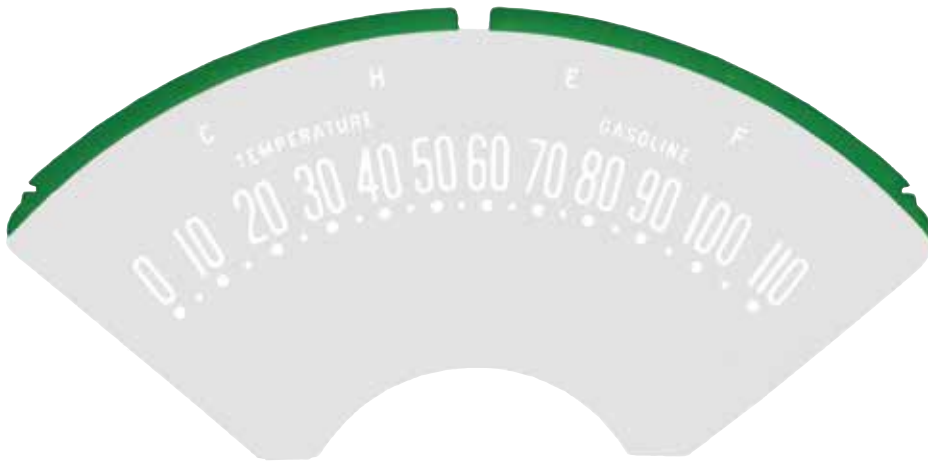

DASH LENSES Please note all lenses are clear, but grayed to show details in photo.



DASH LENS SETS

These highly polished, injection moulded lenses have been reproduced to duplicate the originals exactly. Our top-quality plastic and highly polished moulds make them the clearest lenses on the market. All numbers and letters are recessed on the back side and painted white. Edges of the lenses are painted green to transmit color to the letters when backlit, just like Chevy produced them in '55, '56 and '57. Please note all lenses are clear. **Made in the USA.**

SETS:

1955-56 Standard Transmission... #299.....	\$36.95/set
1955-56 Auto. Transmission #298.....	\$43.95/set
1957..... #300.....	\$64.95/set

SOLD SEPARATELY:

1955-56 Speedometer, Standard & Automatic #298A.....	\$29.95/ea.
1955-56 Clock Face, Standard & Auto.; 1958-62 Vette #298B.....	\$19.95/ea.
1955-56 Trans. Indicator, Powerglide #298C.....	\$14.95/ea.
1957 Speedometer #300A.....	\$29.95/ea.
1957 Temperature Gauge #300B.....	\$19.95/ea.
1957 Gas Gauge #300C.....	\$20.95/ea.
1957 Clock Face #300D.....	\$18.95/ea.

RADIO LENSES

Whether you're removing the radio for service or want to detail the dash, remember to replace the radio lens. Sharp details are cast in crystal clear quality acrylic. Letters and numbers are recessed and painted white.

1955 Pushbutton	#1849.....	\$33.95/ea.
1955 Wonder Bar	#1850.....	\$33.95/ea.
1956 Pushbutton	#1851.....	\$33.95/ea.
1956 Wonder Bar	#1852.....	\$35.95/ea.
1957 Pushbutton or Wonder Bar ...	#1853.....	\$33.95/ea.

#1282



HEATER CONTROL FACE PLATE AND LENSES

Plastic parts can yellow and crack with age. These face plates are crystal clear! Printed in white and green as they were originally.

1955-56	#1281.....	\$27.95/ea.
1957.....	#1282.....	\$23.50/ea.

#1281



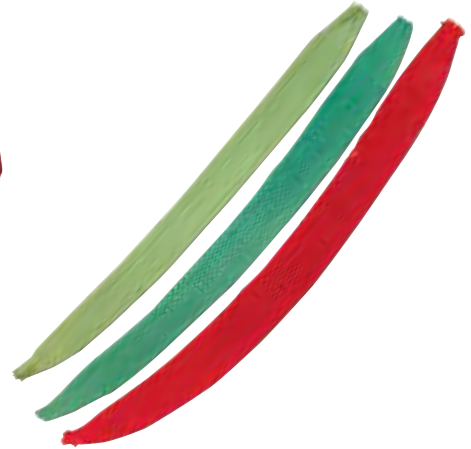

PACKAGE SHELVES O/S

1955-57 Black, 2-Door Hardtop	#536	\$20.95/ea.
1956-57 Black, 4-Door Hardtop	#536A	\$20.95/ea.
1955-57 Black, 2 & 4-Door Sedan	#536B	\$20.95/ea.
1955-57 Red, 2-Door Hardtop	#12913 ..	\$18.95/ea.
1955-57 Dark Green, 2-Door Hardtop	#12914 ..	\$18.95/ea.
1955-57 Dark Blue, 2-Door Hardtop	#12915 ..	\$18.95/ea.
1955-57 Gray, 2-Door Hardtop	#12916 ..	\$18.95/ea.
1955-57 Turquoise, 2-Door Hardtop	#12917 ..	\$18.95/ea.
1955-57 Blue, 2-Door Hardtop	#12918 ..	\$18.95/ea.
1955-57 Green, 2-Door Hardtop	#12919 ..	\$30.95/ea.
1955-57 Red, 2 & 4-Door Sedan	#12920 ..	\$18.95/ea.
1955-57 Dark Green, 2 & 4-Door Sedan	#12921 ..	\$18.95/ea.
1955-57 Blue, 2 & 4-Door Sedan	#12922 ..	\$18.95/ea.
1955-57 Gray, 2 & 4-Door Sedan	#12923 ..	\$18.95/ea.
1955-57 Turquoise, 2 & 4-Door Sedan	#12924 ..	\$18.95/ea.
1955-57 Green, 2 & 4-Door Sedan	#12925 ..	\$30.95/ea.
1955-57 Brown, 2 & 4-Door Sedan.....	#12926 ..	\$18.95/ea.
1955-57 Red, 4-Door Hardtop	#12927 ..	\$18.95/ea.
1955-57 Dark Green, 4-Door Hardtop	#12928 ..	\$18.95/ea.
1955-57 Blue, 4-Door Hardtop	#12929 ..	\$18.95/ea.
1955-57 Turquoise, 4-Door Hardtop	#12930 ..	\$18.95/ea.
1955-57 Green, 4-Door Hardtop	#12931 ..	\$30.95/ea.

PULL STRAPS

1955-57 Black, Sedan	#13168...	\$70.95/pr.
1955-57 Dark Blue, Sedan	#13169...	\$70.95/pr.
1955-57 Dark Green, Sedan	#13170...	\$70.95/pr.
1955-57 Turquoise, Sedan	#13171...	\$70.95/pr.
1955-57 Maroon, Sedan	#13172...	\$70.95/pr.
1955-57 Light Blue, Sedan	#13173...	\$70.95/pr.
1955-57 Gray, Sedan	#13174...	\$70.95/pr.
1955-57 Copper, Sedan	#13175...	\$70.95/pr.
1955-57 Beige, Sedan	#13176...	\$70.95/pr.
1955-57 Brown, Sedan	#13177...	\$70.95/pr.
1955-57 Red, Sedan	#13178...	\$70.95/pr.
1955-57 Light Green, Sedan	#13179...	\$70.95/pr.
1955-57 Ivory, Sedan	#13180...	\$70.95/pr.
1955-57 Fawn, Sedan	#13181...	\$70.95/pr.
1955-57 Coral, Sedan	#13182...	\$70.95/pr.



PULL STRAP TIPS

1955-57 Chrome, w/ Screws	#14633...	\$16.95/pr.
---------------------------------	-----------	-------------

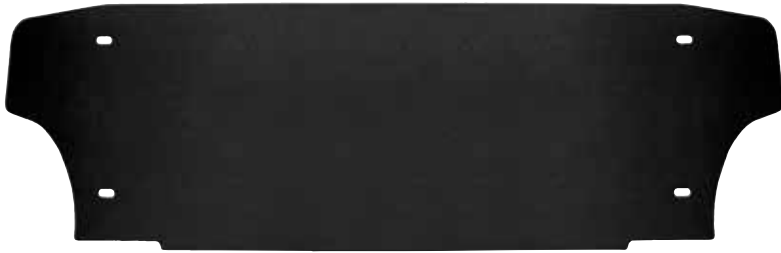

TRUNK CARDBOARD PANELS O/S

Available in black and die-cut as per the original pattern.
Made in the USA.

- 1955-57 2-Door Hardtop..... #588..... \$25.95/ea.
- 1955-57 4-Door Hardtop, All Sedans
 #589..... \$25.95/ea.

CUSTOM TRUNK PANEL KIT O/S

Shown on page 163.

- 1955-57 4-Piece..... #14856..... \$224.95/kit



REAR SEAT PANEL CARDBOARD O/S

Comes in black and is die cut per original pattern.

- 1955-57 Convertible..... #12281 \$35.95/ea.

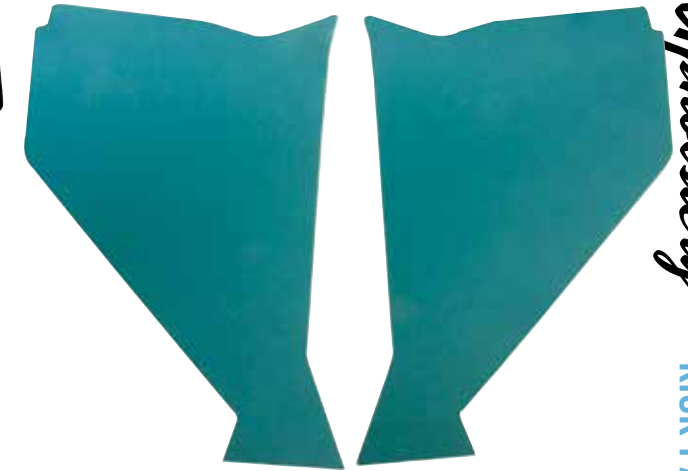

KICK PANELS

- 1955 Red #12900 \$19.95/pr.
- 1955 Dark Green #12901 \$19.95/pr.
- 1955 Dark Blue #12902 \$19.95/pr.
- 1955 Gray #12903 \$19.95/pr.
- 1955 Turquoise #12904 \$19.95/pr.
- 1956 Red #12905 \$19.95/pr.
- 1956 Dark Green #12906 \$19.95/pr.
- 1956 Blue #12907 \$19.95/pr.
- 1956 Turquoise #12908 \$19.95/pr.
- 1957 Red #12909 \$19.95/pr.
- 1957 Green #12910 \$19.95/pr.
- 1957 Blue #12911 \$19.95/pr.
- 1957 Turquoise #12912 \$19.95/pr.



#482

#481
 (#480 SIMILIAR)

BLACK PAINTABLE KICK PANELS

These panels are black and textured with a vinyl-style finish. Easily painted to match your original interior color or upholstered for custom interior applications. Sold in pairs. **Made in the USA.**

- 1955 #480 \$21.95/pr.
- 1956..... #481 \$21.95/pr.
- 1957..... #482 \$21.95/pr.

WARNING! Products on these pages may contain chemicals known to the State Of California to cause cancer and/or birth defects or reproductive harm. www.p65warnings.ca.gov



TMI CUSTOM UPHOLSTERY INTERIORS

Danchuk Manufacturing has teamed up with TMI to offer you custom interiors specifically tailored and stitched for your Tri-Five. These are complete turn-key interior kits that can be installed by you or a shop with basic tools. For example, the seats come fully upholstered and assembled ready to install, no special tools or upholstery skills required. With the freedom to choose the pattern, colors, material and even the stitching color when you order your TMI interior kit, the possibilities are endless. Only a few examples are shown in the following pages, but options are only limited by your imagination. Gone are the days of having your project tied up at the upholstery shop for months on end when you can do-it-yourself or hire a shop to install it in just a matter of days instead of months. Because TMI interiors are completely custom, there is no way for Danchuk to advertise an exact price. Please call for samples and to quote to begin the ordering process. **All prices listed are BASE PRICES ONLY.** All TMI orders are made to order and are special orders and cannot be returned. Please allow 8-10 weeks for delivery on complete interiors. Individual items normally take less turnaround time. All TMI orders do not qualify for free shipping promotions.

How to order your custom TMI interior in just a few steps:

- 1. Choose Your Style:** Choose which of the TMI styles offered you want to order.
- 2. Choose Your Colors:** Decide what colors you want to go with. TMI offers numerous choices and combinations in upholstery and stitching. We highly recommend calling us to order swatches before placing your order, so you know exactly what you are getting.
- 3. Choose Your Items:** Decide which items you want to order. Ordering items at different times/orders cannot guarantee that dye lots will always match perfectly.
- 4. Call Danchuk:** Give us a call and we will provide you with a quote. Depending on the complexity of your order, we may need to make inquiries with TMI in order to provide the most accurate quote. This would also be a good time to order swatches.
- 5. Place Your Order:** Orders will only be placed once quotes are signed-off for accuracy. Please ask all questions before you sign-off on your order being placed.



FRONT SEAT SPLIT BACK BENCH

1955-57 Sport.....	#19364...	<i>Starting at</i> \$1230.95/ea.
1955-57 Sport-XR	#19365...	\$1703.95/ea.
1955-57 Sport-FXR.....	#19366...	\$1988.95/ea.

All prices listed are BASE PRICES ONLY. Call for a quote.

LOW BACK SEATS



PRO-SERIES UNIVERSAL LOW BACK SPORT SEATS WITH HEADRESTS

Sport Seats.....#19175.....	\$1130.95/pr.
Sport-X Seats#19176.....	\$1609.95/pr.
Sport-XR Seats#19177.....	\$1736.95/pr.
Sport-FX Seats.....#19178.....	\$1729.95/pr.
Sport-FXR Seats.....#19179.....	\$1798.95/pr.

Starting at

PRO-SERIES UNIVERSAL LOW BACK SPORT SEATS WITHOUT HEADRESTS

Sport Seats.....#19180.....	\$974.95/pr.
Sport-X Seats#19181.....	\$1420.95/pr.
Sport-XR Seats#19182.....	\$1560.95/pr.
Sport-FX Seats.....#19183.....	\$1548.95/pr.
Sport-FXR Seats.....#19184.....	\$1609.95/pr.

Starting at

SPORT REAR SEATS



2-DOOR HARDTOP REAR SEATS WITH CONSOLES

1955-57 Sport.....	#19185...	\$1679.95/ea.
1955-57 Sport-X	#19186...	\$2032.95/ea.
1955-57 Sport-XR	#19187...	\$2235.95/ea.
1955-57 Sport-FX.....	#19188...	\$1997.95/ea.
1955-57 Sport-FXR.....	#19189...	\$2458.95/ea.

2-DOOR HARDTOP REAR SEATS WITHOUT CONSOLES

1955-57 Sport.....	#19190...	\$1236.95/ea.
1955-57 Sport-X	#19191...	\$1497.95/ea.
1955-57 Sport-XR	#19192...	\$1646.95/ea.
1955-57 Sport-FX.....	#19193...	\$1487.95/ea.
1955-57 Sport-FXR.....	#19194...	\$1811.95/ea.

2-DOOR SEDAN REAR SEATS WITH CONSOLES

1955-57 Sport.....	#19195...	\$1679.95/ea.
1955-57 Sport-X	#19196...	\$2032.48/ea.
1955-57 Sport-XR	#19197...	\$2235.95/ea.
1955-57 Sport-FX.....	#19198...	\$1997.95/ea.
1955-57 Sport-FXR.....	#19199...	\$2458.95/ea.

2-DOOR SEDAN REAR SEATS WITHOUT CONSOLES

1955-57 Sport.....	#19200...	\$1236.95/ea.
1955-57 Sport-X	#19201...	\$1497.95/ea.
1955-57 Sport-XR	#19202...	\$1646.95/ea.
1955-57 Sport-FX.....	#19203...	\$1487.95/ea.
1955-57 Sport-FXR.....	#19204...	\$1811.95/ea.



CONSOLES

CONSOLES ONLY FRONT FULL LENGTH

1955-56 Sport.....	#19229.....	\$485.95/ea.
1955-56 Sport-X	#19230.....	\$662.95/ea.
1955-56 Sport-XR	#19231.....	\$750.95/ea.
1955-56 Sport-FX.....	#19232.....	\$750.95/ea.
1957 Sport.....	#19237.....	\$485.95/ea.
1957 Sport-X.....	#19238.....	\$662.95/ea.
1957 Sport-FX.....	#19239.....	\$750.95/ea.
1957 Sport-FXR.....	#19240.....	\$750.95/ea.

Starting at

FRONT FULL LENGTH WITH BUCKET AND SHIFT BOOT

1955-56 Sport.....	#19233.....	\$600.95/ea.
1955-56 Sport-X	#19234.....	\$777.95/ea.
1955-56 Sport-XR	#19235.....	\$865.95/ea.
1955-56 Sport-FXR.....	#19236.....	\$865.95/ea.
1957 Sport.....	#19241.....	\$600.95/ea.
1957 Sport-X.....	#19242.....	\$777.95/ea.
1957 Sport-XR.....	#19243.....	\$865.95/ea.
1957 Sport-FXR.....	#19244.....	\$865.95/ea.

WARNING! Products on these pages may contain chemicals known to the State Of California to cause cancer and/or birth defects or reproductive harm. www.p65warnings.ca.gov

DASH PADS

Upholstery

SPORT-FX

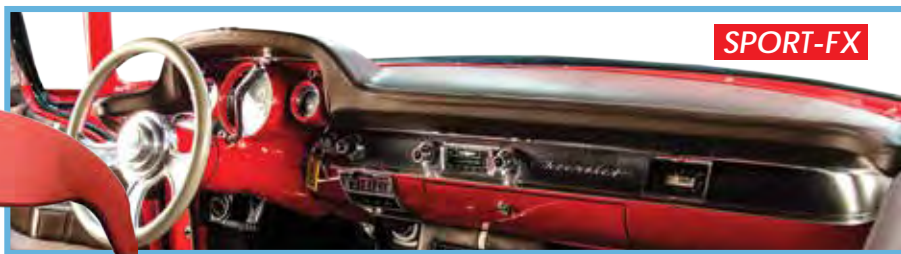

SPORT

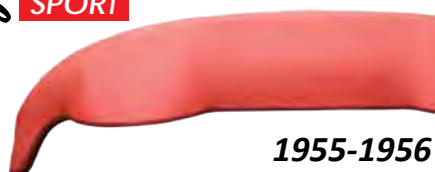

1955-1956

SPORT-FXR



1957

SPORT DASH PADS

Starting at

1955-56 Sport Dash Pad.....	#19205.....	\$529.95/ea.
1955-56 Sport-R Dash Pad.....	#19206.....	\$618.95/ea.
1955-56 Sport-FXR Dash Pad.....	#19207.....	\$706.95/ea.
1957 Sport Dash Pad.....	#19208.....	\$529.95/ea.
1957 Sport-R Dash Pad.....	#19209.....	\$618.95/ea.
1957 Sport-FXR Dash Pad.....	#19210.....	\$706.95/ea.

DOOR PANELS



SPORT



SPORT-FX

2-DOOR HARDTOP & CONVERTIBLE FRONT SPORT MOLDED DOOR PANELS

Starting at

1955-57 Sport.....	#19211.....	\$618.95/pr.
1955-57 Sport-FX.....	#19212.....	\$764.95/pr.
1955-57 Sport-FXR.....	#19213.....	\$794.95/pr.

2-DOOR SEDAN & NOMAD FRONT SPORT MOLDED DOOR PANELS

Starting at

1955-57 Sport.....	#19217.....	\$618.95/pr.
1955-57 Sport-FX.....	#19218.....	\$764.95/pr.
1955-57 Sport-FXR.....	#19219.....	\$794.95/pr.

4-PIECE, 4-DOOR WAGON DOOR PANEL SETS

4-Door wagon sets use flat panels. Includes front and rear.

1955-57 Sport.....	#19223.....	\$618.95/set
1955-57 Sport-FX.....	#19224.....	\$934.95/set
1955-57 Sport-FXR.....	#19225.....	\$971.95/set

All prices listed are
BASE PRICES ONLY.
Call for a quote.

QUARTER PANELS

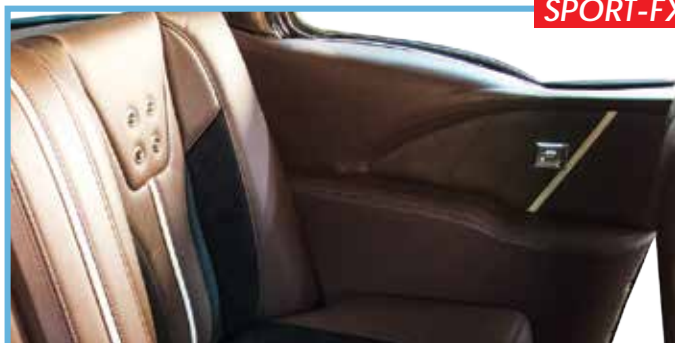

SPORT-FX



SPORT



2-DOOR HARDTOP REAR QUARTER PANELS

Starting at

1955-57 Sport.....	#19214.....	\$441.95/pr.
1955-57 Sport-FX.....	#19215.....	\$594.95/pr.
1955-57 Sport-FXR.....	#19216.....	\$618.95/pr.

2-DOOR SEDAN REAR QUARTER PANELS

Starting at

1955-57 Sport.....	#19220.....	\$441.95/pr.
1955-57 Sport-FX.....	#19221.....	\$594.95/pr.
1955-57 Sport-FXR.....	#19222.....	\$618.95/pr.

SPORT KICK PANELS WITHOUT SPEAKER HOLES

Starting at

1955.....	#19226.....	\$72.95/pr.
1956.....	#19227.....	\$72.95/pr.
1957.....	#19228.....	\$72.95/pr.

MOLDED KICK PANELS

Starting at

1955-56 for 6" Speakers.....	#19424.....	\$129.95/pr.
1957 for 6" Speakers.....	#19425.....	\$129.95/pr.

SEAT MOUNT BRACKETS

Starting at

1955-57 Bucket.....	#19292.....	\$213.95/pr.
1955-57 Bench.....	#19293.....	\$213.95/pr.

KICK PANELS



HEADLINERS & VISORS

Upholstery

2-DOOR HARDTOP MOLDED HEADLINERS

1955 Sport.....	#19245.....	\$485.95/ea.	<i>Starting at</i>
1955 Sport-R.....	#19246.....	\$574.95/ea.	
1955 Sport FXR.....	#19247.....	\$662.95/ea.	
1956-57 Sport.....	#19248.....	\$485.95/ea.	
1956-57 Sport-R.....	#19249.....	\$574.95/ea.	
1956-57 Sport FXR.....	#19250.....	\$662.95/ea.	

2-DOOR SEDAN MOLDED HEADLINERS

1955 Sport.....	#19251.....	\$485.95/ea.	<i>Starting at</i>
1955 Sport-R.....	#19252.....	\$574.95/ea.	
1955 Sport FXR.....	#19253.....	\$662.95/ea.	

SPORT MOLDED VISORS EXCEPT CONVERTIBLE

1955-57 Sport.....	#19254.....	\$154.95/pr.	<i>Starting at</i>
1955-57 Sport-R.....	#19255.....	\$176.95/pr.	

CONVERTIBLE SPORT MOLDED VISORS

1955-57 Sport.....	#19256.....	\$154.95/pr.	<i>Starting at</i>
1955-57 Sport-R.....	#19257.....	\$176.95/pr.	

TMI

STEERING WHEELS



14" SPORT STEERING WHEELS

1955-57 Sport, Flat Black, 1-Color.....	#19258.....	\$318.95/ea.	<i>Starting at</i>
1955-57 Sport, Flat Black, 2-Color.....	#19259.....	\$363.95/ea.	
1955-57 Sport FXR, Flat Black, 1-Color.....	#19260.....	\$397.95/ea.	
1955-57 Sport, Polished, 1-Color.....	#19261.....	\$318.95/ea.	
1955-57 Sport, Polished, 2-Color.....	#19262.....	\$363.95/ea.	
1955-57 Sport FXR, Polished, 1-Color.....	#19263.....	\$397.95/ea.	

STEERING WHEEL HUB KITS

1955-57 Flat Black.....	#19264.....	\$73.95/ea.	<i>Starting at</i>
1955-57 Polished.....	#19265.....	\$73.95/ea.	

CARPET KITS



STANDARD LOOP CARPET KITS

1955-57 2-Door Hardtop & Conv. . .	#19266.....	\$264.95/kit	<i>Starting at</i>
1955-57 2-Door Sedan.....	#19267.....	\$264.95/kit	
1955-57 4-Door Sedan.....	#19268.....	\$264.95/kit	
1955-57 4-Door Wagon with Rear Area.....	#19269.....	\$353.95/kit	

FLOORMATS

1955-57 Black.....	#19270.....	\$79.95/kit	<i>Starting at</i>
--------------------	-------------	-------------	--------------------

PACKAGE TRAYS



SPORT PACKAGE TRAYS

1955-57 2-Door Hardtop, Charcoal Black.....	#19271.....	\$220.95/ea.	<i>Starting at</i>
1955-57 2-Door & 4-Door Sedan..	#19272.....	\$220.95/ea.	

SPORT PODS FOR PACKAGE TRAYS

1955-57 Sport.....	#19273.....	\$154.95/pr.	<i>Starting at</i>
1955-57 Sport-R.....	#19274.....	\$176.95/pr.	
1955-57 Sport-XR.....	#19275.....	\$202.95/pr.	
1955-57 Sport-FXR.....	#19276.....	\$220.95/pr.	

2-DOOR HARDTOP & SEDAN SPORT TRUNK KITS & LIDS

1955-57 Sport.....	#19277.....	\$441.95/kit
1955-57 Sport LID.....	#19277A...	\$331.95/ea.
1955-57 Sport-XR.....	#19278.....	\$706.95/kit
1955-57 Sport-XR LID.....	#19278A...	\$530.95/ea.

TRUNK KITS

All prices listed are
BASE PRICES ONLY.
Call for a quote.



WARNING! Products on these pages may contain chemicals known to the State Of California to cause cancer and/or birth defects or reproductive harm. www.p65warnings.ca.gov

1955 Interior Swatches

'55 INTERIORS

TRIM #511



BEIGE VINYL W/
BROWN PATTERN
CLOTH

TRIM #503



DARK BLUE
GABARDINE W/
LT. BLUE PATTERN
CLOTH

TRIM #504

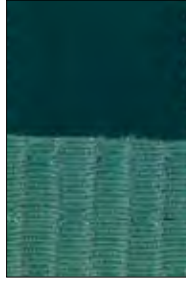

DARK GREEN GABAR-
DINE W/LIGHT GREEN
PATTERN CLOTH

TRIM #505



BROWN
GABARDINE W/LIGHT
TAN
PATTERN CLOTH

TRIM #506



BEIGE
VINYL W/BLUE VINYL

TRIM #507



BEIGE
VINYL W/
GREEN VINYL

TRIM #508



IVORY
VINYL W/
BLACK VINYL

TRIM #509



LIGHT BLUE
VINYL W/DARK BLUE
PATTERN CLOTH

TRIM #510



LIGHT GREEN
VINYL W/DARK GREEN
PATTERN CLOTH

TRIM #513



IVORY VINYL W/
TURQUOISE
PATTERN CLOTH

TRIM #514



BEIGE
VINYL W/ DARK BLUE
RIBBED VINYL

TRIM #515



LIGHT GREEN
VINYL W/DARK GREEN
RIBBED VINYL

TRIM #516



BEIGE VINYL W/
BROWN RIBBED VINYL

TRIM #517



LIGHT BEIGE
VINYL W/STRAW PAT-
TERN CLOTH

TRIM #518



BLUE VINYL W/STRAW
PATTERN CLOTH

TRIM #519



LT. BLUE VINYL W/
STRAW
PATTERN CLOTH

TRIM #520



LT. GREEN VINYL W/
STRAW
PATTERN CLOTH

TRIM #521



RED VINYL W/STRAW
PATTERN CLOTH

TRIM #522



TURQUOISE
VINYL W/STRAW
PATTERN CLOTH

TRIM #525



BEIGE VINYL W/
RED VINYL

TRIM #526



BEIGE VINYL W/
RED VINYL

TRIM #527



LIGHT BLUE VINYL W/
DARK BLUE VINYL

TRIM #528



BEIGE VINYL W/
BROWN VINYL

TRIM #531



CORAL VINYL W/ GRAY
PATTERN CLOTH

1956 Interior Swatches

Upholstery

'56 INTERIORS

TRIM #560

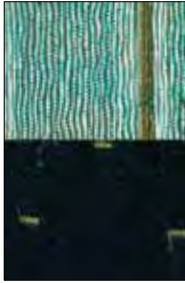

BEIGE, GOLD STRIPE VINYL W/ BLACK, GOLD DOTTED PATTERN

TRIM #562



BEIGE, GOLD STRIPE VINYL W/ GREEN VINYL

TRIM #564



STARFROST VINYL W/ CHARCOAL GRAY PATTERN CLOTH

TRIM #565



STARFROST VINYL W/ DARK GREEN PATTERN CLOTH

TRIM #566



STARFROST VINYL W/ DARK BLUE PATTERN CLOTH

TRIM #567

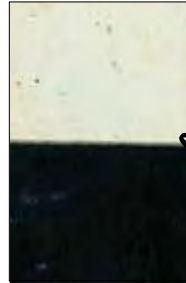

IVORY VINYL W/ BLACK VINYL

TRIM #568



IVORY VINYL W/ DARK GREEN VINYL

TRIM #569



IVORY VINYL W/ DARK TURQUOISE VINYL

TRIM #570



STARFROST VINYL W/ DARK GREEN PATTERN VINYL

TRIM #572

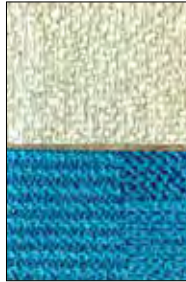

STARFROST VINYL W/ DARK TURQUOISE PATTERN VINYL

TRIM #573

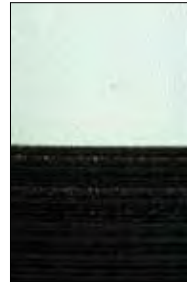

IVORY VINYL W/ CHARCOAL GRAY PATTERN CLOTH

TRIM #574



LIGHT GREEN VINYL W/ DARK GREEN PATTERN CLOTH

TRIM #575



LIGHT BLUE VINYL W/ DARK BLUE PATTERN CLOTH

TRIM #578



YELLOW VINYL W/ CHARCOAL GRAY PATTERN CLOTH

TRIM #579



IVORY VINYL W/ CHARCOAL GRAY PATTERN CLOTH

TRIM #580



LIGHT GREEN VINYL W/ DARK GREEN PATTERN CLOTH

TRIM #581



LIGHT BLUE VINYL W/ DARK BLUE PATTERN CLOTH

TRIM #583



RED VINYL W/ BEIGE PATTERN CLOTH

TRIM #584



LT. TURQUOISE VINYL W/ DARK TURQUOISE PATTERN CLOTH

TRIM #603



IVORY VINYL W/ TURQUOISE PATTERN VINYL

TRIM #605



IVORY VINYL W/ RED PATTERN VINYL

TRIM #609



STARFROST VINYL W/ CHARCOAL GRAY PATTERN CLOTH

TRIM #617

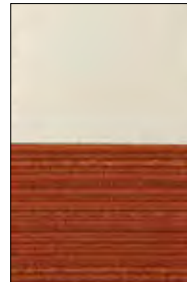

TAN VINYL W/ COPPER PATTERN CLOTH

TRIM #607



LT. BLUE VINYL W/ DARK BLUE PATTERN VINYL



WARNING! Products on these pages may contain chemicals known to the State Of California to cause cancer and/or birth defects or reproductive harm. www.p65warnings.ca.gov

1957 Interior Swatches

TRIM #650



BLACK VINYL W/
BLACK AND GRAY
PATTERN CLOTH

TRIM #654



IVORY VINYL W/
CHARCOAL
PATTERN CLOTH

TRIM #655



WAGON ONLY
LIGHT GREEN VINYL
W/ DARK GREEN PAT-
TERN VINYL

TRIM #656



LIGHT BLUE VINYL W/
DARK BLUE PATTERN
CLOTH

TRIM #670

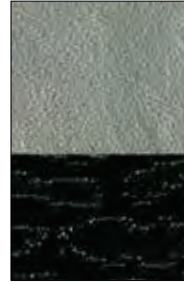

SILVER VINYL W/
BLACK AND SILVER
PATTERN CLOTH

TRIM #671



LIGHT GREEN VINYL
W/ BLACK AND GREEN
PATTERN CLOTH

TRIM #672



LIGHT BLUE VINYL W/
BLACK AND BLUE
PATTERN CLOTH

TRIM #673



LT. TURQUOISE
VINYL W/ BLACK AND
TURQUOISE PATTERN
CLOTH

TRIM #674



BEIGE VINYL W/
BLACK AND COPPER
PATTERN CLOTH

TRIM #675



YELLOW VINYL W/
BLACK AND YELLOW
PATTERN CLOTH

TRIM #676



RED VINYL W/ BLACK
AND RED PATTERN
CLOTH

TRIM #677



IVORY VINYL W/SIL-
VER PATTERN VINYL

TRIM #678



LIGHT GREEN VINYL
W/ DARK GREEN
PATTERN VINYL

TRIM #679



LIGHT BLUE VINYL W/
DARK BLUE PATTERN
VINYL

TRIM #680



IVORY VINYL W/
TURQUOISE
PATTERN VINYL

TRIM #681

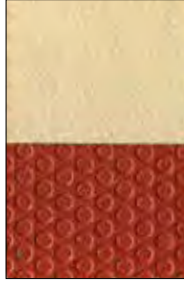

BEIGE VINYL W/ COP-
PER PATTERN VINYL

TRIM #682



YELLOW VINYL W/
SILVER
PATTERN VINYL

TRIM #683



RED VINYL W/ SILVER
PATTERN VINYL

TRIM #659



WAGON ONLY
BEIGE VINYL W/ COP-
PER PATTERN VINYL

IF YOU ARE ORDERING AN INTERIOR, PLEASE READ THIS IMPORTANT INFORMATION.

- ALL INTERIOR ORDERS ARE SPECIAL ORDERS, and therefore are non-returnable. Danchuk requires customers to sign a waiver form that states customer agrees to the terms of the order, and that colors and styles are correct. Customers have the option to have samples of interior and carpet materials mailed to them before signing the waiver, to ensure you are ordering the correct color and style. If you would like to have samples sent to you, either email us at custserv@danchuk.com, or call us at (800) 854-6911 during our normal business hours, 7am to 5pm PST Monday through Friday, and 8am to 2pm PST on Saturdays. We also require interior orders to be prepaid including appropriate freight charges. Please call for a freight quote if sending a check or money order. Allow 6 to 8 weeks for delivery of interiors, and 7 to 10 business days for delivery of carpets.
- Your interior item(s) will be shipped to you directly from our supplier. If you live in the State of California or Michigan your order will be shipped to us first and we will in turn ship it to you. Please inspect your shipment immediately upon receipt. If there are any defective or missing parts, please notify us immediately by calling (714) 751-1957. Call as soon as possible so that we can make every attempt to rectify the situation. Due to our supplier's policies, we cannot take responsibility for any defects or shortages not reported within 10 days of receipt of order.
- Stock style reproduction interiors are duplicates of the originals. TMI Interiors are a custom interior with original designs by TMI. TMI interiors are NOT an original style interior. Workmanship and fit are guaranteed by the manufacturer. Materials subject to change without notice; please call our interiors department before ordering. Interior orders are non-returnable under normal circumstances; however, should you experience a problem with fit, workmanship, incorrect items, or damages, please call for return information. Please don't ship your order back to us until you have contacted our returns department.
- To identify sedans from hardtops, all sedan models have a post between the side windows. Hardtop models have no post between the side windows. Glide front seat frames will incur an extra \$125 custom set-up fee.

1955 BEL AIR-2-DOOR SEDAN

Seat Covers - Front & Rear

Pre-sewn in original woven cloth and haircell vinyls, in original colors with all listings attached, ready to install. Set includes covers for front and rear sets and enough material to cover seat caps.

TRIM#	COLOR DESCRIPTION	DANCHUK PART#	PRICE
509	Dark Blue Cloth with Light Blue Vinyl	#11361	\$718.95
531	Dark Gray Cloth with Coral Vinyl	#11362	\$718.95
513	Turquoise Cloth with Ivory Vinyl	#11363	\$718.95
511	Dark Brown Cloth with Beige Vinyl	#11364	\$718.95
510	Dark Green Cloth with Light Green Vinyl	#11365	\$718.95
549	Dark Gray Cloth with Ivory Vinyl	#11366	\$718.95

Pre-Assembled Door Panels 2-Door

Pre-Assembled front and rear panels, in original style materials, on new boards with metal door edge bands attached. Includes windlace, kick panels and enough material to cover the armrests. Stainless trim is available for an additional charge. Front armrest bases not included.

TRIM#	COLOR DESCRIPTION	DANCHUK PART#	PRICE
509	Dark Blue Cloth with Light Blue Vinyl	#11367	\$778.95
531	Dark Gray Cloth with Coral Vinyl	#11368	\$778.95
513	Turquoise Cloth with Ivory Vinyl	#11369	\$778.95
511	Dark Brown Cloth with Beige Vinyl	#11370	\$778.95
510	Dark Green Cloth with Light Green Vinyl	#11371	\$778.95
549	Dark Gray Cloth with Ivory Vinyl	#11372	\$778.95

Stainless Interior Door Panel Trim Kit

	DANCHUK PART#	PRICE
All	#1911	\$365.95

Front Armrest Bases

TRIM#	COLOR DESCRIPTION	DANCHUK PART#	PRICE
All	Metal and Plastic Armrest Bases (B/A only)	#11429	\$224.95

Front Armrest Pads

TRIM#	COLOR DESCRIPTION	DANCHUK PART#	PRICE
All	Molded Rubber Armrest Pads (B/A only)	#11427	\$89.95

Glide front seat frames will incur an extra \$125 custom set-up fee.

Front Door Handle Cup

TRIM#	COLOR DESCRIPTION	DANCHUK PART#	PRICE
All	Metal Cup for Front Armrest	#11300	\$15.95

Headliner - Original Material

Pre-sewn napped cloth with visor and upper post material included.

TRIM#	COLOR DESCRIPTION	DANCHUK PART#	PRICE
509	Blue Cloth	#11373	\$159.95
531	Coral Cloth	#11374	\$159.95
513	Turquoise Cloth	#11375	\$159.95
511	Beige Cloth	#11376	\$159.95
510	Green Cloth	#11377	\$159.95
549	Gray Cloth	#11378	\$159.95

Tack Strip Set

TRIM#	COLOR DESCRIPTION	DANCHUK PART#	PRICE
All	55 2-Dr Sedan Tack Strips	#11311	\$49.95

Sunvisors (Pair) - Original Material

Sewn in napped cloth on new boards with new rods and chrome clips.

TRIM#	COLOR DESCRIPTION	DANCHUK PART#	PRICE
509	Blue Cloth	#11379	\$147.95
531	Coral Cloth	#11380	\$147.95
513	Turquoise Cloth	#11381	\$147.95
511	Beige Cloth	#11382	\$147.95
510	Green Cloth	#11383	\$147.95
549	Gray Cloth	#11384	\$147.95

Daytona Carpet - Original Style

Original tight weave Daytona, ready to install, with foam backing, correct heel pad and binding.

TRIM#	COLOR DESCRIPTION	DANCHUK PART#	PRICE
509	Dark Blue	#11949	\$458.95
531	Gray	#11950	\$458.95
513	Turquoise	#11951	\$458.95
511	Brown	#11952	\$458.95
510	Dark Green	#11953	\$458.95
549	Gray	#11950	\$458.95

WARNING! Products on these pages may contain chemicals known to the State Of California to cause cancer and/or birth defects or reproductive harm. www.p65warnings.ca.gov

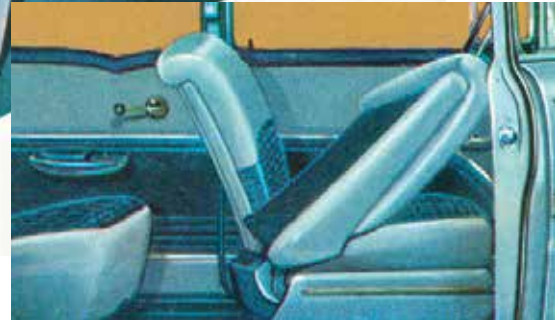

1955 BEL AIR 4-DOOR SEDAN

Seat Covers - Front & Rear

Pre-sewn in original woven cloth and haircell vinyls, in original colors with all listings attached, ready to install. Set includes covers for front and rear seats and enough material to cover the seat caps.

TRIM#	COLOR DESCRIPTION	DANCHUK PART#	PRICE
509	Dark Blue Cloth with Light Blue Vinyl	#11385	\$718.95
531	Dark Gray Cloth with Coral Vinyl	#11386	\$718.95
513	Turquoise Cloth with Ivory Vinyl	#11387	\$718.95
511	Dark Brown Cloth with Beige Vinyl	#11388	\$718.95
510	Dark Green Cloth with Light Green Vinyl	#11389	\$718.95
549	Dark Gray Cloth with Ivory Vinyl	#11390	\$718.95

Pre-Assembled Door Panels 4-Door

Pre-assembled front and rear door panels with new rear upper panels, in original style materials, on new boards with metal door edge bands attached. Includes windlace, kick panels and pre-sewn armrest covers. Stainless trim is available for an additional charge. Front armrest bases not included.

TRIM#	COLOR DESCRIPTION	DANCHUK PART#	PRICE
509	Dark Blue Cloth with Light Blue Vinyl	#11391	\$818.95
531	Dark Gray Cloth with Coral Vinyl	#11392	\$818.95
513	Turquoise Cloth with Ivory Vinyl	#11393	\$818.95
511	Dark Brown Cloth with Beige Vinyl	#11394	\$818.95
510	Dark Green Cloth with Light Green Vinyl	#11395	\$818.95
549	Dark Gray Cloth with Ivory Vinyl	#11396	\$818.95

Stainless Interior Door Panel Trim Kit

	DANCHUK PART#	PRICE
All	#11319	\$404.95

Front Armrest Pads

TRIM#	COLOR DESCRIPTION	DANCHUK PART#	PRICE
All	Molded Rubber Armrest Pads, B/A only	#11427	\$89.95

Rear Armrest Pads

TRIM#	COLOR DESCRIPTION	DANCHUK PART#	PRICE
All	Molded Rubber Armrest Pads	#11428	\$89.95

Glide front seat frames will incur an extra \$125 custom set-up fee.

Front Door Handle Cups

TRIM#	COLOR DESCRIPTION	DANCHUK PART#	PRICE
All	Metal Front Handle Cup	#11300	\$15.95

Headliner - Original Material

Pre-sewn napped cloth with visor and upper post material included.

TRIM#	COLOR DESCRIPTION	DANCHUK PART#	PRICE
509	Blue Cloth	#11373	\$159.95
531	Coral Cloth	#11374	\$159.95
513	Turquoise Cloth	#11375	\$159.95
511	Beige Cloth	#11376	\$159.95
510	Green Cloth	#11377	\$159.95
549	Gray Cloth	#11378	\$159.95

Tack Strip Set

TRIM#	COLOR DESCRIPTION	DANCHUK PART#	PRICE
All	55 4-Dr Sedan Tack Strip Set	#11313	\$41.95

Sunvisors (Pair) - Original Material

Sewn in napped cloth on new boards with new rods and chrome clips.

TRIM#	COLOR DESCRIPTION	DANCHUK PART#	PRICE
509	Blue Cloth	#11379	\$147.95
531	Coral Cloth	#11380	\$147.95
513	Turquoise Cloth	#11381	\$147.95
511	Beige Cloth	#11382	\$147.95
510	Green Cloth	#11383	\$147.95
549	Gray Cloth	#11384	\$147.95

Daytona Carpet - Original Style

Original tight weave Daytona, ready to install, with foam backing, correct heel pad and binding.

TRIM#	COLOR DESCRIPTION	DANCHUK PART#	PRICE
509	Dark Blue	#11954	\$458.95
531	Gray	#11955	\$458.95
513	Turquoise	#11956	\$458.95
511	Brown	#11957	\$458.95
510	Dark Green	#11958	\$458.95
549	Gray	#11955	\$458.95



1955 BEL AIR 2-DOOR HARDTOP

Seat Covers - Front & Rear

Pre-sewn in original straw pattern cloth and heavy weight vinyls, in original colors with all listings attached, ready to install. Set includes covers for front and rear seats and enough material to cover the seat caps.

TRIM#	COLOR DESCRIPTION	DANCHUK PART#	PRICE
519	Beige Straw Pattern Cloth with Lt. Blue Vinyl	#11409	\$658.95
532	Gray Straw Pattern Cloth with Coral Vinyl	#11410	\$658.95
522	Beige Straw Pattern Cloth with Turq. Vin.	#11411	\$658.95
521	Beige Straw Pattern Cloth with Red Vinyl	#11412	\$658.95
520	Beige Straw Pattern Cloth with Lt. Green Vinyl	#11413	\$658.95
550	Gray Straw Pattern Cloth with Ivory Vinyl	#11414	\$658.95

Pre-Assembled Door Panels 2-Door

Pre-assembled front and rear upper panels, in original style materials, on new boards with metal door edge bands attached. Includes windlace, kick panels, material to cover the front armrests and sewn rear arm rest covers. Stainless trim is available for an additional charge. Front armrest bases not included.

TRIM#	COLOR DESCRIPTION	DANCHUK PART#	PRICE
519	Beige Vinyl with Light Blue Vinyl	#11415	\$728.95
532	Gray Vinyl with Coral Vinyl	#11416	\$728.95
522	Beige Vinyl with Turquoise Vinyl	#11417	\$728.95
521	Beige Vinyl with Red Vinyl	#11418	\$728.95
520	Beige Vinyl with Light Green Vinyl	#11419	\$728.95
550	Gray Vinyl with Ivory Vinyl	#11420	\$728.95

Stainless Interior Door Panel Trim Kit

	DANCHUK PART#	PRICE
All	#1436	\$404.95

Front Armrest Bases

TRIM#	COLOR DESCRIPTION	DANCHUK PART#	PRICE
All	Metal and Plastic Armrest Bases, B/A only	#11430	\$224.95

Front Ammrest Pads

TRIM#	COLOR DESCRIPTION	DANCHUK PART#	PRICE
All	Molded Rubber Armrest Pads, B/A only	#11427	\$89.95

Front Door Handle Cup

TRIM#	COLOR DESCRIPTION	DANCHUK PART#	PRICE
All	Metal Cup for Front Armrest	#11300	\$15.95

Headliner - Original Material

Pre-sewn plain vinyl with visor material included.

TRIM#	COLOR DESCRIPTION	DANCHUK PART#	PRICE
519	Beige Vinyl	#11421	\$159.95
532	Coral Vinyl	#11422	\$159.95
522	Beige Vinyl	#11421	\$159.95
521	Beige Vinyl	#11421	\$159.95
520	Beige Vinyl	#11421	\$159.95
550	Ivory Vinyl	#11423	\$159.95

Tack Strips Set

TRIM#	COLOR DESCRIPTION	DANCHUK PART#	PRICE
All	2-Door Hardtop Tack Strip Set	#11309	\$59.95

Sunvisors (Pair) - Original Material

Sewn in rain vinyl on new boards with new rods and chrome clips.

TRIM#	COLOR DESCRIPTION	DANCHUK PART#	PRICE
519	Beige Vinyl	#11424	\$147.95
532	Coral Vinyl	#11425	\$147.95
522	Beige Vinyl	#11424	\$147.95
521	Beige Vinyl	#11424	\$147.95
520	Beige Vinyl	#11424	\$147.95
550	Ivory Vinyl	#11426	\$147.95

Daytona Carpet - Original Style

Original tight weave Daytona, ready to install, with foam backing, correct heel pad and binding.

TRIM#	COLOR DESCRIPTION	DANCHUK PART#	PRICE
519	Light Blue	#11959	\$458.95
532	Gray	#11960	\$458.95
522	Turquoise	#11961	\$458.95
521	Red	#11962	\$429.95
520	Light Green	#11963	\$458.95
550	Gray	#11960	\$458.95
	Option Black	#11964	\$458.95

Glide front seat frames will incur an extra \$125 custom set-up fee.

WARNING! Products on these pages may contain chemicals known to the State Of California to cause cancer and/or birth defects or reproductive harm. www.p65warnings.ca.gov



1955 CONVERTIBLE

Seat Covers - Front & Rear

Pre-sewn in correct heavyweight vinyls with saddle stitched pleats, all listings attached, ready to install. Set includes covers for front and rear seats and enough material to cover the seat caps.

TRIM#	COLOR DESCRIPTION	DANCHUK PART#	PRICE
525	Red and Beige Vinyl.....	#11437	\$768.95
527	Dark Blue and Light Blue Vinyl	#11438	\$768.95
533	Dark Gray and Coral Vinyl	#11439	\$768.95
551	Dark Gray and Ivory Vinyl	#11440	\$768.95
526	Light Green and Dark Green Vinyl.....	#11441	\$768.95
528	Brown and Beige Vinyl.....	#11442	\$768.95
537	Turquoise and Ivory Vinyl.....	#11443	\$768.95

Pre-Assembled Door Panels 2-Door

Pre-assembled front and rear upper panels, in original style materials, on new boards with metal door edge bands attached. Includes windlace, kick panels, material to cover the front armrests and sewn rear armrest and piston covers. Stainless trim is available for an additional charge. Front armrest bases not included.

TRIM#	COLOR DESCRIPTION	DANCHUK PART#	PRICE
525	Red and Beige Vinyl.....	#11444	\$728.95
527	Dark Blue and Light Blue Vinyl	#11445	\$728.95
533	Dark Gray and Coral Vinyl	#11446	\$728.95
551	Dark Gray and Ivory Vinyl	#11447	\$728.95
526	Light Green and Dark Green Vinyl.....	#11448	\$728.95
528	Brown and Beige Vinyl.....	#11449	\$728.95
537	Turquoise and Ivory Vinyl.....	#11450	\$728.95

Stainless Interior Door Panel Trim Kit

	DANCHUK PART#	PRICE
All	#1437	\$404.95

Front Armrest Bases

TRIM#	COLOR DESCRIPTION	DANCHUK PART#	PRICE
All	Metal and Plastic Armrest Bases, B/A only	#11430	\$224.95

Front Armrest Pads

TRIM#	COLOR DESCRIPTION	DANCHUK PART#	PRICE
All	Molded Rubber Armrest Pads, B/A only	#11427	\$89.95

Front Door Handle Cup

TRIM#	COLOR DESCRIPTION	DANCHUK PART#	PRICE
All	Metal Cup for Front Armrest.....	#11300	\$15.95

Rear Armrest and Piston Cover

TRIM#	COLOR DESCRIPTION	DANCHUK PART#	PRICE
All	Armrest and Piston Cover, per pair	#2204	\$379.95

Convertible Top Header Strips

TRIM#	COLOR DESCRIPTION	DANCHUK PART#	PRICE
All	Convertible Top Header Strips	#1523	\$76.95

Convertible Top Tack Strips

TRIM#	COLOR DESCRIPTION	DANCHUK PART#	PRICE
All	Convertible Top Tack Strips.....	#1521	\$34.95

Convertible Top

Made from 36 oz. GM pinpoint vinyl with plastic back window, sewn as original. Top and junior side pads are included.

TRIM#	COLOR DESCRIPTION	DANCHUK PART#	PRICE
All	Black/Black.....	#11451	\$498.95
All	White/Black	#11452	\$498.95
All	Beige/Biege	#11453	\$498.95
All	Dark Blue/Black.....	#11454	\$799.95

Sunvisors (Pair) - Original Material

Sewn in original vinyl material on new boards with new rods and chrome clips.

TRIM#	COLOR DESCRIPTION	DANCHUK PART#	PRICE
525	Red Vinyl.....	#11455	\$147.95
527	Dark Blue Vinyl.....	#11456	\$147.95
533	Gray Vinyl.....	#11457	\$147.95
551	Gray Vinyl.....	#11457	\$147.95
526	Dark Green Vinyl.....	#11458	\$147.95
528	Brown Vinyl.....	#11459	\$147.95
537	Turquoise Vinyl.....	#11460	\$147.95

Convertible Top Well

Correctly sewn and ready to install.

TRIM#	COLOR DESCRIPTION	DANCHUK PART#	PRICE
All	Black.....	#11462	\$79.95
All	Turquoise	#11629	\$89.95
All	Beige.....	#11628	\$89.95

Convertible Top Boot Cover

Pre-sewn in vinyl, complete with Naugastay stiffener and snaps (not installed).

TRIM#	COLOR DESCRIPTION	DANCHUK PART#	PRICE
525	Beige	#11463	\$255.95
527	Dark Blue	#11464	\$255.95
533	Coral	#11465	\$255.95
551	Ivory	#11466	\$255.95
526	Dark Green	#11467	\$255.95
528	Beige	#11463	\$255.95
537	Ivory	#11466	\$255.95

Daytona Carpet - Original Style

Original tight weave Daytona, ready to install, with foam backing, correct heel pad and binding.

TRIM#	COLOR DESCRIPTION	DANCHUK PART#	PRICE
525	Red	#11969	\$458.95
527	Dark Blue	#11970	\$458.95
533	Gray	#11971	\$458.95
551	Gray	#11971	\$458.95
526	Dark Green	#11972	\$458.95
528	Brown	#11973	\$458.95
537	Turquoise	#11974	\$458.95

Glide front seat frames will incur an extra \$125 custom set-up fee.

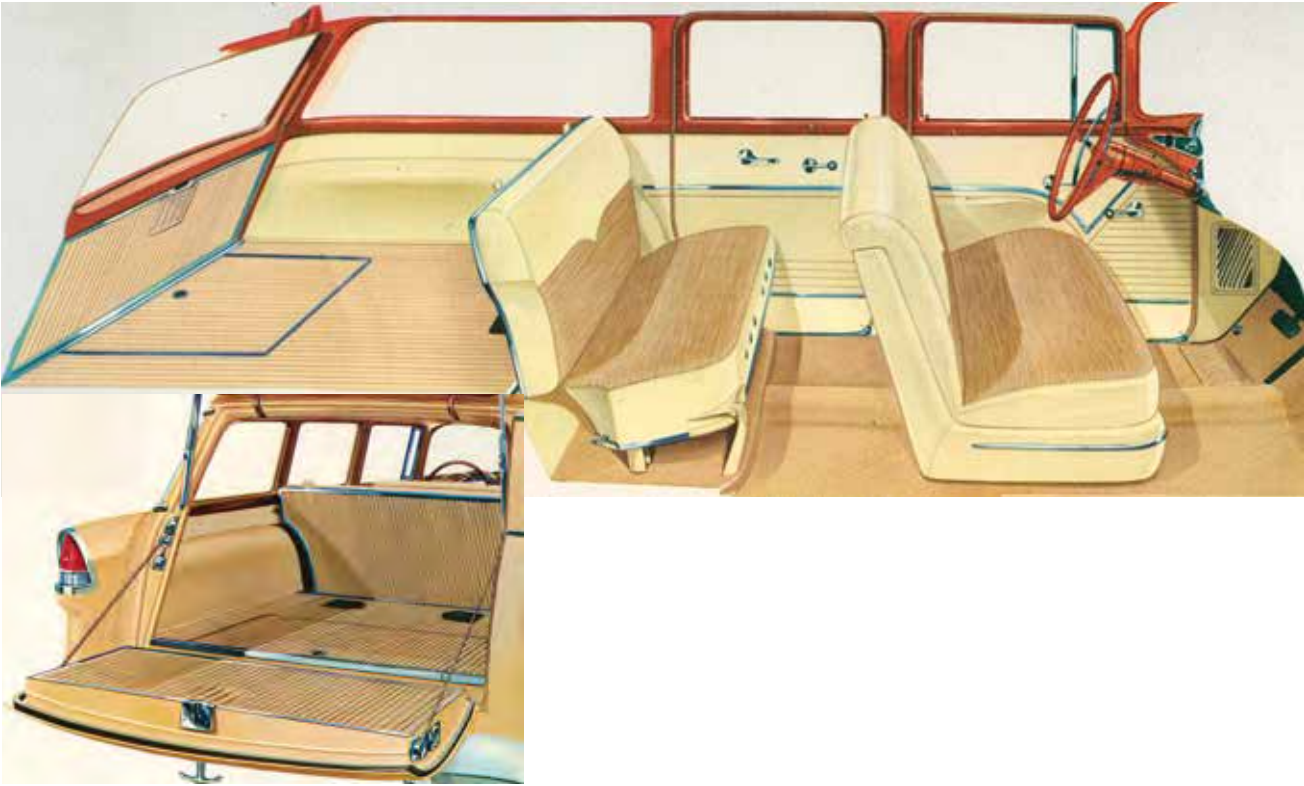

1955 BEL AIR 6 PASSENGER 4-DOOR WAGON

Seat Covers - Front & Rear

Pre-sewn in heavy weight vinyl with straw cloth with all listings attached, ready to install. Set includes covers for front and rear seats and enough material to cover the seat caps.

TRIM#	COLOR DESCRIPTION	DANCHUK PART#	PRICE
517	Beige Vinyl with Beige Cloth.....	#11432.....	\$659.95
518	Beige Cloth with Blue Vinyl.....	#11433.....	\$659.95

Pre-Assembled Door Panels 4-Door

Pre-assembled front and rear panels on new boards with metal door edge bands attached. Includes windlace, kick panels, wheelwell covers, over the wheel well boards and material to cover the armrests. Stainless door trim and front armrest bases are not included.

TRIM#	COLOR DESCRIPTION	DANCHUK PART#	PRICE
517	Beige Vinyl with Beige Cloth.....	#11434.....	\$789.95
518	Beige Vinyl with Blue Cloth.....	#11435.....	\$789.95

Headliner - Original Material

Pre-sewn vinyl with visor and upper post material included.

TRIM#	COLOR DESCRIPTION	DANCHUK PART#	PRICE
517	Beige Vinyl.....	#11436.....	\$189.95
518	Beige Vinyl.....	#11436.....	\$189.95

Glide front seat frames will incur an extra \$125 custom set-up fee.

Tack Strip Set

TRIM#	COLOR DESCRIPTION	DANCHUK PART#	PRICE
All	4-Door Wagon Tack Strip Set.....	#11316.....	\$53.95

Sunvisors (Pair) - Original Material

Sewn in original vinyl material on new boards with new rods and chrome clips.

TRIM#	COLOR DESCRIPTION	DANCHUK PART#	PRICE
517	Beige Vinyl.....	#11424.....	\$147.95
518	Beige Vinyl.....	#11424.....	\$147.95

Daytona Carpet - Original Style

Original tight weave Daytona, ready to install, with foam backing, correct heel pad and binding.

TRIM#	COLOR DESCRIPTION	DANCHUK PART#	PRICE
517	Beige.....	#11965.....	\$458.95
518	Blue.....	#11996.....	\$458.95

Daytona Cargo Area Carpet

TRIM#	COLOR DESCRIPTION	DANCHUK PART#	PRICE
517	Beige Carpet.....	#11967.....	\$312.95
518	Blue Carpet.....	#11968.....	\$312.95



1955 NOMAD

Seat Covers - Front & Rear

Pre-sewn using heavy di-electric pressed vinyl waffle inserts with full sewn pleated sections, all listings attached, ready to install. Set includes covers for front and rear seats and enough material to cover the seat caps.

TRIM#	COLOR DESCRIPTION	DANCHUK PART#	PRICE
541	Beige Vinyl and Green Waffle.....	#11469.....	\$858.95
543	Beige Vinyl and Brown Waffle.....	#11470.....	\$858.95
545	Ivory Vinyl and Turquoise Waffle.....	#11471.....	\$858.95
552	Ivory Vinyl and Gray Waffle.....	#11472.....	\$858.95
542	Beige Vinyl and Blue Waffle.....	#11473.....	\$858.95
544	Beige Vinyl and Red Waffle.....	#11474.....	\$858.95
546	Coral Vinyl and Gray Waffle.....	#11475.....	\$858.95

Pre-Assembled Door Panels 2-Door

Pre-assembled front and rear panels on new boards with metal door edge bands attached. Includes windlace, kick panels, wheelwell covers, over the wheel well boards. Stainless trim is available for an additional charge. Armrest bases and pads included.

TRIM#	COLOR DESCRIPTION	DANCHUK PART#	PRICE
541	Beige Vinyl and Green Waffle.....	#11476.....	\$919.95
543	Beige Vinyl and Brown Waffle.....	#11477.....	\$919.95
545	Ivory Vinyl and Turquoise Waffle.....	#11478.....	\$919.95
552	Ivory Vinyl and Gray Waffle.....	#11479.....	\$919.95
542	Beige Vinyl and Blue Waffle.....	#11480.....	\$919.95
544	Beige Vinyl and Red Waffle.....	#11481.....	\$919.95
546	Coral Vinyl and Gray Waffle.....	#11482.....	\$919.95

Stainless Interior Door Panel Trim Kit

	DANCHUK PART#	PRICE
All	#11318.....	\$681.95

Armrest Base

TRIM#	COLOR DESCRIPTION	DANCHUK PART#	PRICE
All	Metal Armrest Base, Nomad only.....	#11431.....	\$124.95

Armrest Pads

TRIM#	COLOR DESCRIPTION	DANCHUK PART#	PRICE
All	Molded Rubber Armrest Pads.....	#11428.....	\$89.95

Armrest Cups

TRIM#	COLOR DESCRIPTION	DANCHUK PART#	PRICE
All	Metal Front Door Armrest Cups.....	#11300.....	\$15.95

Tack Strip Set

TRIM#	COLOR DESCRIPTION	DANCHUK PART#	PRICE
All	Nomad Headliner Tack Strips.....	#11310.....	\$77.95

Glide front seat frames will incur an extra \$125 custom set-up fee.

Headliner

Pre-sewn perforated vinyl with visor and B-Pillar material included.

TRIM#	COLOR DESCRIPTION	DANCHUK PART#	PRICE
541	Beige Perforated Vinyl.....	#11483.....	\$198.95
543	Beige Perforated Vinyl.....	#11483.....	\$198.95
545	Ivory Perforated Vinyl.....	#11484.....	\$198.95
552	Ivory Perforated Vinyl.....	#11484.....	\$198.95
542	Beige Perforated Vinyl.....	#11483.....	\$198.95
544	Beige Perforated Vinyl.....	#11483.....	\$198.95
546	Coral Perforated Vinyl.....	#11485.....	\$198.95

Sunvisors (Pair)

Sewn in original material on new boards with new rods and chrome clips.

TRIM#	COLOR DESCRIPTION	DANCHUK PART#	PRICE
541	Beige Perforated Vinyl.....	#11486.....	\$147.95
543	Beige Perforated Vinyl.....	#11486.....	\$147.95
545	Ivory Perforated Vinyl.....	#11487.....	\$147.95
552	Ivory Perforated Vinyl.....	#11487.....	\$147.95
542	Beige Perforated Vinyl.....	#11486.....	\$147.95
544	Beige Perforated Vinyl.....	#11486.....	\$147.95
546	Coral Perforated Vinyl.....	#11488.....	\$147.95

Daytona Carpet - Original Style

Original tight weave Daytona, ready to install, with foam backing, correct heel pad and binding.

TRIM#	COLOR DESCRIPTION	DANCHUK PART#	PRICE
541	Green, Light.....	#11975.....	\$458.95
543	Brown.....	#11976.....	\$458.95
545	Turquoise.....	#11977.....	\$458.95
552	Gray.....	#11978.....	\$458.95
542	Blue, Light.....	#11979.....	\$458.95
544	Red.....	#11980.....	\$458.95
546	Gray.....	#11978.....	\$458.95

Daytona Cargo Area Carpet

Cargo area carpet (Daytona) in place of linoleum.

TRIM#	COLOR DESCRIPTION	DANCHUK PART#	PRICE
541	Light Green.....	#11985.....	\$312.95
543	Brown.....	#11986.....	\$312.95
545	Turquoise.....	#11987.....	\$312.95
552	Gray.....	#11988.....	\$312.95
542	Light Blue.....	#11989.....	\$312.95
544	Red.....	#11990.....	\$312.95
546	Gray.....	#11988.....	\$312.95



1955 210 2-DOOR HARDTOP

Seat Covers - Front & Rear

Pre-sewn in correct bar pattern and plain bolster cloth, in original colors with all listings attached, ready to install. Set includes covers for front and rear seats and enough material to cover the seat caps.

TRIM#	COLOR DESCRIPTION	DANCHUK PART#	PRICE
503	Lt Blue Pattern Cloth with Dk Blue Plain Cloth	#11489	\$768.95
504	Lt Green Pattern Cloth with Dk Green Plain Cloth	#11490	\$768.95
505	Lt Brown Pattern Cloth with Lt Brown Plain Cloth	#17651	\$768.95

Pre-Assembled Door Panels 2-Door

Pre-assembled front and rear upper panels, in original style materials, on new boards with metal door edge bands attached. Includes windlace, kick panels, material to cover the front armrests and sewn rear arm rest covers. Stainless trim is available for an additional charge.

TRIM#	COLOR DESCRIPTION	DANCHUK PART#	PRICE
503	Light Blue Pattern Vinyl with Dark Blue Vinyl	#11491	\$778.95
504	Light Green Pattern Vinyl with Dark Green Vinyl	#11492	\$778.95
505	Lt Brown Pattern Cloth with Lt Brown Vinyl	#17652	\$778.95

1955 210 2-DOOR SEDAN

Seat Covers - Front & Rear

Pre-sewn in correct bar pattern and plain bolster cloth, in original colors with all listings attached, ready to install. Set includes covers for front and rear seats and enough material to cover the seat caps.

TRIM#	COLOR DESCRIPTION	DANCHUK PART#	PRICE
503	Lt Blue Pattern Cloth with Dk Blue Plain Cloth	#11497	\$768.95
504	Lt Green Pattern Cloth with Dk Green Plain Cloth	#11498	\$768.95
505	Lt Brown Pattern Cloth w/ Brown Plain Cloth	#17654	\$768.95

Pre-Assembled Door Panels 2-Door

Pre-assembled front and rear panels, in original style materials, on new boards with metal door edge bands attached. Includes windlace, kick panels and enough material to cover the armrests. Stainless trim is available for an additional charge.

TRIM#	COLOR DESCRIPTION	DANCHUK PART#	PRICE
503	Light Blue Pattern Vinyl with Dark Blue Vinyl	#11495	\$778.95
504	Light Green Pattern Vinyl with Dark Green Vinyl	#11496	\$778.95
505	Lt Brown with Brown Vinyl	#17660	\$778.95

Stainless Interior Door Panel Trim Kit

	DANCHUK PART#	PRICE
All	#2042	\$174.95

Glide front seat frames will incur an extra \$125 custom set-up fee.

Headliner - Original Material

Pre-sewn napped cloth with visor material included.

TRIM#	COLOR DESCRIPTION	DANCHUK PART#	PRICE
503	Blue Cloth	#11981	\$158.95
504	Green Cloth	#11982	\$159.95
505	Beige Cloth	#17653	\$159.95

Tack Strip Set

TRIM#	COLOR DESCRIPTION	DANCHUK PART#	PRICE
All	2-Dr Hardtop Tack Strips	#11309	\$59.95

Sunvisors (Pair)

Sewn in original material on new boards with new rods and chrome clips.

TRIM#	COLOR DESCRIPTION	DANCHUK PART#	PRICE
503	Blue Cloth	#11379	\$147.95
504	Green Cloth	#11383	\$147.95
505	Beige Cloth	#11382	\$147.95

Daytona Carpet-Original Style

Original tight weave Daytona, ready to install, with foam backing, correct heel pad and binding

TRIM#	COLOR DESCRIPTION	DANCHUK PART#	PRICE
503	Lt. Blue	#11959	\$458.95
504	Lt. Green	#11963	\$458.95
505	Brown	#11973	\$458.95

Headliner - Original Material

Pre-sewn napped cloth with visor and upper post material included.

TRIM#	COLOR DESCRIPTION	DANCHUK PART#	PRICE
503	Blue Cloth	#11373	\$159.95
504	Green Cloth	#11377	\$159.95
505	Beige Cloth	#11376	\$159.95

Tack Strip Set

TRIM#	COLOR DESCRIPTION	DANCHUK PART#	PRICE
All	2-Dr Sedan Tack Strips	#11311	\$49.95

Sunvisors (Pair)

Sewn in original material on new boards with new rods and chrome clips.

TRIM#	COLOR DESCRIPTION	DANCHUK PART#	PRICE
503	Blue Cloth	#11379	\$147.95
504	Green Cloth	#11383	\$147.95

Daytona Carpet - Original Style

Original tight weave Daytona, ready to install, with foam backing, correct heel pad and binding.

TRIM#	COLOR DESCRIPTION	DANCHUK PART#	PRICE
503	Dark Blue	#11949	\$458.95
504	Dark Green	#11953	\$458.95
505	Brown	#11952	\$458.95



1955 210 4-DOOR SEDAN

Seat Covers - Front & Rear

Pre-sewn in correct bar pattern and plain bolster cloth, in original colors with all listings attached, ready to install. Set includes covers for front and rear seats and enough material to cover the seat caps.

TRIM#	COLOR DESCRIPTION	DANCHUK PART#	PRICE
503	Lt. Blue Pattern Cloth with Dark Blue Plain Cloth	#11493	\$768.95
504	Lt. Green Pattern Cloth with Dark Green Plain Cloth	#11494	\$768.95

Pre-Assembled Door Panels 4-Door

Pre-Assembled front and rear door panels with new rear upper panels, in original style materials, on new boards with metal door edge bands attached. Includes windlace, kick panels and enough material to cover the armrests. Stainless trim is available for an additional charge.

TRIM#	COLOR DESCRIPTION	DANCHUK PART#	PRICE
503	Lt. Blue Pattern Vinyl with Dk Blue Vinyl	#11499	\$818.95
504	Lt. Green Pattern Vinyl with Dk Green Vinyl	#11500	\$818.95

Glide front seat frames will incur an extra \$125 custom set-up fee.

1955 210 2-DOOR SEDAN DEL RAY

Seat Covers - Front & Rear

Pre-sewn in correct heavyweight vinyl, in original saddle stitched block design with all listings attached, ready to install. Set includes covers for front and rear seats and enough material to cover the seat caps.

TRIM#	COLOR DESCRIPTION	DANCHUK PART#	PRICE
506	Light Blue and Beige Vinyl	#11501	\$768.95
507	Light Green and Beige Vinyl	#11502	\$768.95
508	Black and Ivory Vinyl	#11503	\$768.95

Pre-Assembled Door Panels - 2-Door

Pre-assembled front and rear panels, in original style materials, on new boards with metal door edge bands attached. Includes windlace, kick panels and enough material to cover the armrests. Stainless trim is available for an additional charge.

TRIM#	COLOR DESCRIPTION	DANCHUK PART#	PRICE
506	Light Blue and Beige Vinyl	#11504	\$778.95
507	Light Green and Beige Vinyl	#11505	\$778.95
508	Black and Ivory Vinyl	#11506	\$778.95

Stainless Interior Door Panel Trim Kit

	DANCHUK PART#	PRICE
All	#2043	\$174.95

Headliner - Original Material

Pre-sewn napped cloth with visor and upper post material included.

TRIM#	COLOR DESCRIPTION	DANCHUK PART#	PRICE
503	Blue Cloth	#11373	\$159.95
504	Green Cloth	#11377	\$159.95
505	Beige Cloth	#11376	\$159.95

Tack Strip Set

TRIM#	COLOR DESCRIPTION	DANCHUK PART#	PRICE
All	4-Dr Sedan Tack Strips	#11313	\$41.95

Sunvisors (Pair)

Sewn in napped cloth on new boards with new rods and chrome clips.

TRIM#	COLOR DESCRIPTION	DANCHUK PART#	PRICE
503	Blue Cloth	#11379	\$147.95
504	Green Cloth	#11383	\$147.95
505	Beige Cloth	#11382	\$147.95

Daytona Carpet - Original Style

Original tight weave Daytona, ready to install, with foam backing, correct heel pad and binding.

TRIM#	COLOR DESCRIPTION	DANCHUK PART#	PRICE
503	Dark Blue	#11954	\$458.95
504	Dark Green	#11958	\$458.95
505	Brown	#11957	\$458.95

Tack Strip Set

TRIM#	COLOR DESCRIPTION	DANCHUK PART#	PRICE
All	2-Dr Sedan Tack Strips	#11311	\$49.95

Headliner - Original Material

Pre-sewn vinyl with visor material included.

TRIM#	COLOR DESCRIPTION	DANCHUK PART#	PRICE
506	Beige	#11507	\$159.95
507	Beige	#11507	\$159.95
508	Ivory	#11508	\$159.95

Sunvisors (Pair) - Original Material

Sewn in vinyl on new boards with new rods and chrome clips.

TRIM#	COLOR DESCRIPTION	DANCHUK PART#	PRICE
508	Ivory	#11426	\$147.95
507	Beige	#11424	\$147.95

Daytona Carpet - Original Style

Original tight weave Daytona, ready to install, with foam backing, correct heel pad and binding.

TRIM#	COLOR DESCRIPTION	DANCHUK PART#	PRICE
506	Lt Blue	#11983	\$458.95
507	Lt Green	#11984	\$458.95
508	Black	#11995	\$458.95



1955 210 2 AND 4-DOOR WAGONS

Pre-Assembled Door Panels 2 & 4-Doors

Pre-assembled front and rear panels on new boards with metal door edge bands attached. Includes windlace, kick panels, wheelwell covers, over the wheel well boards and material to cover the armrests.

TRIM#	COLOR DESCRIPTION	DANCHUK PART#	PRICE
514	Dark Blue and Beige Vinyl, 2-Door	#14556	\$778.95
515	Dark Green and Green Vinyl, 2-Door	#14557	\$778.95
516	Brown and Beige Vinyl, 2-Door	#14558	\$778.95
514	Dark Blue and Beige Vinyl, 4-Door	#11512	\$818.95
515	Dark Green and Green Vinyl, 4-Door	#11513	\$818.95
516	Brown and Beige Vinyl, 4-Door	#11514	\$818.95

Seat Covers - Front & Rear

Pre-sewn in heavyweight plain vinyl and ribbed false-stitch vinyl with all listings attached, ready to install. Set includes covers for front and rear seats and enough material to cover the seat caps.

TRIM#	COLOR DESCRIPTION	DANCHUK PART#	PRICE
514	Dark Blue and Beige Vinyl, 2-Door	#14553	\$768.95
515	Dark Green and Green Vinyl, 2-Door	#14554	\$768.95
516	Brown and Beige Vinyl, 2-Door	#14555	\$768.95
514	Dark Blue and Beige Vinyl, 4-Door	#11509	\$768.95
515	Dark Green and Green Vinyl, 4-Door	#11510	\$768.95
516	Brown and Beige Vinyl, 4-Door	#11511	\$768.95

Headliner - Original Material

Pre-sewn vinyl with visor material included.

TRIM#	COLOR DESCRIPTION	DANCHUK PART#	PRICE
514	Beige Vinyl	#11515	\$198.95
516	Beige Vinyl	#11515	\$198.95
515	Green Vinyl	#14559	\$198.95

1955 150 2-DOOR SEDAN

Seat Covers - Front & Rear

Pre-sewn in heavyweight vinyl and "interlocking diamond" cloth with all listings attached, ready to install. Set includes covers for front and rear seats and enough material to cover the seat caps.

TRIM#	COLOR DESCRIPTION	DANCHUK PART#	PRICE
500	Gray Cloth with Black Vinyl	#11516	\$768.95

Pre-Assembled Door Panels - 2-Door

Pre-assembled front and rear panels, in original style materials, on new boards with metal door edge bands attached. Includes windlace, kick panels and enough material to cover the armrests.

TRIM#	COLOR DESCRIPTION	DANCHUK PART#	PRICE
500	Gray Cloth with Black Vinyl	#11517	\$778.95

Headliner - Original Material

Pre-sewn nap cloth with visor material included.

TRIM#	COLOR DESCRIPTION	DANCHUK PART#	PRICE
500	Gray Cloth	#11378	\$159.95

Tack Strip Set

TRIM#	COLOR DESCRIPTION	DANCHUK PART#	PRICE
All	2-Dr Wagon Tack Strips	#11315	\$59.95
All	4-Dr Wagon Tack Strips	#11316	\$53.95

Sunvisors (Pair) - Original Material

Sewn in vinyl on new boards with new rods and chrome clips.

TRIM#	COLOR DESCRIPTION	DANCHUK PART#	PRICE
514	Beige Vinyl	#11424	\$147.95
516	Beige Vinyl	#11424	\$147.95
515	Green Vinyl	#14560	\$147.95

Daytona Carpet - Original Style

Original tight weave Daytona, ready to install, with foam backing, correct heel pad and binding.

TRIM#	COLOR DESCRIPTION	DANCHUK PART#	PRICE
514	Dark Blue, 2-Door	#12021	\$458.95
515	Dark Green, 2-Door	#16577	\$458.95
516	Brown, 2-Door	#11976	\$458.95
514	Dark Blue, 4-Door	#11996	\$458.95
515	Dark Green, 4-Door	#11997	\$458.95
516	Brown, 4-Door	#11998	\$458.95

Glide front seat frames will incur an extra \$125 custom set-up fee.

Tack Strip Set

TRIM#	COLOR DESCRIPTION	DANCHUK PART#	PRICE
All	2-Dr. Sedan Headliner Tack Strips	#11311	\$49.95

Sunvisors (Pair)

Sewn in original material on new boards with new rods and chrome clips.

TRIM#	COLOR DESCRIPTION	DANCHUK PART#	PRICE
500	Gray Cloth	#11384	\$147.95

Daytona Carpet - Original Style

Original tight weave Daytona, ready to install, with foam backing, correct heel pad and binding.

TRIM#	COLOR DESCRIPTION	DANCHUK PART#	PRICE
500	Black	#11995	\$458.95
	Option Gray	#11950	\$458.95

Glide front seat frames will incur an extra \$125 custom set-up fee.

WARNING! Products on these pages may contain chemicals known to the State Of California to cause cancer and/or birth defects or reproductive harm. www.p65warnings.ca.gov



1955 150 4-DOOR SEDAN

Seat Covers - Front & Rear

Pre-sewn in heavyweight vinyl and "interlocking diamond" cloth with all listings attached, ready to install. Set includes covers for front and rear seats and enough material to cover the seat caps.

TRIM#	COLOR DESCRIPTION	DANCHUK PART#	PRICE
500	Gray Cloth with Black Vinyl	#11518	\$768.95

Pre-Assembled Door Panels - 4-Door

Pre-Assembled front and rear door panels with new rear upper panels, in original style materials, on new boards with metal door edge bands attached. Includes windlace, kick panels and enough material to cover the armrests.

TRIM#	COLOR DESCRIPTION	DANCHUK PART#	PRICE
500	Gray Cloth with Black Vinyl	#11519	\$818.95

Headliner - Original Material

Pre-sewn napped cloth with visor material included.

TRIM#	COLOR DESCRIPTION	DANCHUK PART#	PRICE
500	Gray Cloth	#11378	\$159.95

Sunvisors (Pair) - Original Material

Sewn in napped material on new boards with new rods and chrome clips.

TRIM#	COLOR DESCRIPTION	DANCHUK PART#	PRICE
500	Gray Cloth	#11384	\$147.95

Tack Strip Set

TRIM#	COLOR DESCRIPTION	DANCHUK PART#	PRICE
All	4-Dr. Sedan Tack Strips	#11314	\$51.95

Daytona Carpet - Original Style

Original tight weave Daytona, ready to install, with foam backing, correct heel pad and binding.

TRIM#	COLOR DESCRIPTION	DANCHUK PART#	PRICE
500	Black	#11999	\$458.95
	Option Gray	#11955	\$458.95

1955 150 2-DOOR WAGON

Seat Covers - Front & Rear

Pre-sewn in heavyweight vinyl and "interlocking diamond" cloth with all listings attached, ready to install. Set includes covers for front and rear seats and enough material to cover the seat caps.

TRIM#	COLOR DESCRIPTION	DANCHUK PART#	PRICE
500	Gray Cloth with Black Vinyl	#11520	\$768.95

Pre-Assembled Door Panels - 2-Door

Pre-assembled front and rear panels on new boards with metal door edge bands attached. Includes windlace, kick panels, wheelwell covers, over the wheel well boards and material to cover the armrests.

TRIM#	COLOR DESCRIPTION	DANCHUK PART#	PRICE
500	Gray Cloth with Black Vinyl	#11521	\$778.95

Headliner - Original Material

Pre-sewn vinyl with visor material included.

TRIM#	COLOR DESCRIPTION	DANCHUK PART#	PRICE
500	Gray Vinyl	#11522	\$198.95

Sunvisors (Pair) - Original Material

Sewn in vinyl on new boards with new rods and chrome clips.

TRIM#	COLOR DESCRIPTION	DANCHUK PART#	PRICE
500	Gray Vinyl	#15516	\$147.95

Daytona Carpet - Original Style

Original tight weave Daytona, ready to install, with foam backing, correct heel pad and binding.

TRIM#	COLOR DESCRIPTION	DANCHUK PART#	PRICE
500	Black	#12000	\$458.95
	Option Gray	#12001	\$458.95

Daytona Cargo Carpet

Cargo area carpet, to replace original linoleum.

TRIM#	COLOR DESCRIPTION	DANCHUK PART#	PRICE
500	Gray	#11988	\$312.95

Glide front seat frames will incur an extra \$125 custom set-up fee.



1956 BEL AIR 2-DOOR HARDTOP

Seat Covers - Front & Rear

Pre-sewn in heavyweight vinyl and correct fleck pattern cloth, with all listings attached, ready to install. Set includes covers for front and rear seats and enough material to cover the seat caps.

NOTE: #585 uses Charcoal and Ivory cloth.

TRIM#	COLOR DESCRIPTION	DANCHUK PART#	PRICE
579	Charcoal and Ivory Pattern Cloth with Ivory Vinyl	#11523	\$768.95
584	Beige and Med Turq Pattern Cloth with Lt Turq Vinyl	#11524	\$768.95
580	Beige and Med Green Pattern Cloth with Lt Green Vinyl	#11525	\$768.95
585	Charcoal and Ivory Pattern Cloth with Yellow Vinyl	#11526	\$768.95
581	Beige and Med Blue Pattern Cloth with Light Blue Vinyl	#11527	\$768.95
618	Beige and Copper Pattern Cloth with a Copper Vinyl	#11528	\$768.95
583	Beige and Red Pattern Cloth with Red Vinyl ...	#11529	\$768.95
628	Beige and Red Pattern Cloth with Red Vinyl ...	#11529	\$768.95

Pre-Assembled Door Panels - 2-Door

Pre-Assembled front and rear upper panels, in original style materials, on new boards with metal door edge bands attached. Front armrests are pre-sewn into the front panels using new armrest pads. Includes windlace, kick panels and sewn rear arm rest covers. Stainless trim is available for an additional charge. Armrest bases included.

TRIM#	COLOR DESCRIPTION	DANCHUK PART#	PRICE
579	Charcoal and Ivory Vinyl	#11530	\$838.95
584	Med Turq with Light Turq Vinyl	#11531	\$838.95
580	Med Green with Light Green Vinyl	#11532	\$838.95
585	Charcoal and Yellow Vinyl	#11533	\$838.95
581	Med Blue with Light Blue Vinyl	#11534	\$838.95
618	Beige with a Copper Vinyl	#11535	\$838.95
583	Beige with Red Vinyl	#11536	\$838.95
628	Beige with Red Vinyl	#11536	\$838.95

Stainless Interior Door Panel Trim Kit

	DANCHUK PART#	PRICE
All	#2037	\$324.95

Front Armrest Bases

TRIM#	COLOR DESCRIPTION	DANCHUK PART#	PRICE
All	ABS Plastic Front Armrest Base, Per Pair	#11537	\$89.95

Front Armrest Rubber Pads

TRIM#	COLOR DESCRIPTION	DANCHUK PART#	PRICE
All	Front or Rear, Per Pair	#11427A	\$89.95

Door Handle Cup

TRIM#	COLOR DESCRIPTION	DANCHUK PART#	PRICE
All	Front Door Metal Handle Cup	#11300	\$15.95

Tack Strip Set

TRIM#	COLOR DESCRIPTION	DANCHUK PART#	PRICE
All	2-Dr. Hardtop Headliner Tack Strips	#11309	\$59.95

Headliner - Original Material

Pre-sewn perforated vinyl with visor material included.

TRIM#	COLOR DESCRIPTION	DANCHUK PART#	PRICE
579	Ivory Perforated Vinyl	#11538	\$168.95
584	Turquoise Perforated Vinyl	#11539	\$168.95
580	Green Perforated Vinyl	#11540	\$168.95
585	Yellow Perforated Vinyl	#11541	\$168.95
581	Blue Perforated Vinyl	#11542	\$168.95
618	Beige Perforated Vinyl	#11543	\$168.95
583	Beige Perforated Vinyl	#11543	\$168.95
628	Beige Perforated Vinyl	#11543	\$168.95

Sunvisors (Pair) - Original Material

Sewn in perforated vinyl on new boards with new rods and chrome clips.

TRIM#	COLOR DESCRIPTION	DANCHUK PART#	PRICE
579	Ivory Perforated Vinyl	#11544	\$147.95
584	Turquoise Perforated Vinyl	#11545	\$147.95
580	Green Perforated Vinyl	#11546	\$147.95
585	Yellow Perforated Vinyl	#11547	\$147.95
581	Blue Perforated Vinyl	#11548	\$147.95
618	Beige Perforated Vinyl	#11549	\$147.95
583	Beige Perforated Vinyl	#11549	\$147.95
628	Beige Perforated Vinyl	#11549	\$147.95

Daytona Carpet - Original Style

Original tight weave Daytona, ready to install, with foam backing, correct heel pad and binding.

TRIM#	COLOR DESCRIPTION	DANCHUK PART#	PRICE
579	Black	#11964	\$458.95
584	Turquoise	#11961	\$458.95
585	Black	#11964	\$458.95
581	Dark Blue	#16578	\$458.95
618	Copper	#12036	\$458.95
583	Red	#11962	\$429.95
628	Red	#11962	\$429.95

Glide front seat frames will incur an extra \$125 custom set-up fee.



1956 BEL AIR 4-DOOR HARDTOP

Seat Covers - Front & Rear

Pre-sewn in heavyweight vinyl and correct fleck pattern cloth, with all listings attached, ready to install. Set includes covers for front and rear seats and enough material to cover the seat caps. NOTE: #585 uses Charcoal and Ivory cloth.

TRIM#	COLOR DESCRIPTION	DANCHUK PART#	PRICE
579	Charcoal and Ivory Pattern Cloth with Ivory Vinyl	#11550	\$768.95
584	Beige and Med Turq Pattern Cloth with Lt Turq Vinyl	#11551	\$768.95
580	Beige and Med Green Pattern Cloth with Lt Green Vinyl	#11552	\$768.95
585	Charcoal and Ivory Pattern Cloth with Yellow Vinyl	#11553	\$768.95
581	Beige and Med Blue Pattern Cloth with Light Blue Vinyl	#11554	\$768.95
618	Beige and Copper Pattern Cloth with a Copper Vinyl	#11555	\$768.95
583	Beige and Red Pattern Cloth with Red Vinyl	#11556	\$768.95
628	Beige and Red Pattern Cloth with Red Vinyl	#11556	\$768.95

Pre-Assembled Door Panels - 4-Door

Pre-Assembled front and rear door panels, in original style materials, on new boards with metal door edge bands attached. Front and rear armrests are pre-sewn into the door panels using new armrest pads. Includes windlace and kick panels. Stainless trim is available for an additional charge. Armrest bases included.

TRIM#	COLOR DESCRIPTION	DANCHUK PART#	PRICE
579	Charcoal with Ivory Vinyl	#11557	\$968.95
584	Dark Turquoise with Lt Turq Vinyl	#11558	\$968.95
580	Dark Green with Lt Green Vinyl	#11559	\$968.95
585	Charcoal with Yellow Vinyl	#11560	\$968.95
581	Dark Blue with Light Blue Vinyl	#11561	\$968.95
618	Beige with a Copper Vinyl	#11562	\$968.95
583	Beige with Red Vinyl	#11563	\$968.95
628	Beige with Red Vinyl	#11563	\$968.95

Stainless Interior Door Panel Trim Kit

	DANCHUK PART#	PRICE
All	#2039	\$324.95

Front or Rear Armrest Bases

TRIM#	COLOR DESCRIPTION	DANCHUK PART#	PRICE
All	ABS Plastic Armrest Base, Per Pair	#11537	\$89.95

Front Armrest Rubber Pads

TRIM#	COLOR DESCRIPTION	DANCHUK PART#	PRICE
All	Front or Rear, Per Pair	#11427A	\$89.95

Door Handle Cup

TRIM#	COLOR DESCRIPTION	DANCHUK PART#	PRICE
All	Front Door Metal Handle Cup	#11300	\$15.95

Headliner - Original Material

Pre-sewn perforated vinyl with visor material included.

TRIM#	COLOR DESCRIPTION	DANCHUK PART#	PRICE
579	Ivory Perforated Vinyl	#11564	\$168.95
584	Turquoise Perforated Vinyl	#11565	\$168.95
580	Green Perforated Vinyl	#11566	\$168.95
585	Yellow Perforated Vinyl	#11567	\$168.95
581	Blue Perforated Vinyl	#11568	\$168.95
618	Beige Perforated Vinyl	#11569	\$168.95
583	Beige Perforated Vinyl	#11569	\$168.95
628	Beige Perforated Vinyl	#11569	\$168.95

Sunvisors (Pair) - Original Material

Sewn in perforated vinyl on new boards with new rods and chrome clips.

TRIM#	COLOR DESCRIPTION	DANCHUK PART#	PRICE
579	Ivory Perforated Vinyl	#11544	\$147.95
584	Turquoise Perforated Vinyl	#11545	\$147.95
580	Green Perforated Vinyl	#11546	\$147.95
585	Yellow Perforated Vinyl	#11547	\$147.95
581	Blue Perforated Vinyl	#11548	\$147.95
618	Beige Perforated Vinyl	#11549	\$147.95
583	Beige Perforated Vinyl	#11549	\$147.95
628	Beige Perforated Vinyl	#11549	\$147.95

Daytona Carpet - Original Style

Original tight weave Daytona, ready to install, with foam backing, correct heel pad and binding.

TRIM#	COLOR DESCRIPTION	DANCHUK PART#	PRICE
579	Black	#12002	\$458.95
584	Turquoise	#12003	\$458.95
580	Dark Green	#12004	\$458.95
585	Black	#12002	\$458.95
581	Dark Blue	#12005	\$458.95
618	Copper	#12006	\$458.95
583	Red	#12007	\$458.95
628	Red	#12007	\$458.95

Glide front seat frames will incur an extra \$125 custom set-up fee.



1956 BEL AIR 2-DOOR SEDAN

Seat Covers - Front & Rear

Pre-sewn in heavyweight vinyl and correct pattern cloth, with all listings attached, ready to install. Set includes covers for front and rear seats and enough material to cover the seat caps.

TRIM#	COLOR DESCRIPTION	DANCHUK PART#	PRICE
573	Charcoal Pattern Cloth with Ivory Vinyl	#11570.....	\$768.95
575	Blue Pattern Cloth with Blue Vinyl.....	#11571.....	\$768.95
578	Charcoal Pattern Cloth with Yellow Vinyl.....	#11572.....	\$768.95
574	Green Pattern Cloth with Green Vinyl.....	#11573.....	\$768.95
577	Turquoise Pattern Cloth with Turquoise Vinyl..	#11574.....	\$768.95
617	Copper Pattern Cloth with Beige Vinyl.....	#11575.....	\$768.95

Pre-Assembled Door Panels - 2-Door

Pre-assembled front and rear upper panels, in original style materials, on new boards with metal door edge bands attached. Front armrests are pre-sewn into the front panels using new armrest pads. Includes windlace, kick panels and material to cover the rear armrests. Stainless trim is available for an additional charge. Armrest bases included.

TRIM#	COLOR DESCRIPTION	DANCHUK PART#	PRICE
573	Charcoal with Ivory Vinyl	#11576.....	\$838.95
575	Blue with Blue Vinyl	#11577.....	\$838.95
578	Charcoal with Yellow Vinyl	#11578.....	\$838.95
574	Green with Green Vinyl	#11579.....	\$838.95
577	Turquoise with Turquoise Vinyl	#11580.....	\$838.95
617	Copper with Beige Vinyl	#11581.....	\$838.95

Please specify color of lower door scuff vinyl when ordering.

Stainless Interior Door Panel Trim Kit

	DANCHUK PART#	PRICE
All	#1438.....	\$324.95

Front Armrest Bases

TRIM#	COLOR DESCRIPTION	DANCHUK PART#	PRICE
All	ABS Plastic Armrest Base, Per Pair.....	#11537.....	\$89.95

Front Armrest Rubber Pads

TRIM#	COLOR DESCRIPTION	DANCHUK PART#	PRICE
All	Front, Per Pair.....	#11427A	\$89.95

Glide front seat frames will incur an extra \$125 custom set-up fee.

Headliner - Napped Cloth

Pre-sewn napped cloth with visor and upper post material included.

TRIM#	COLOR DESCRIPTION	DANCHUK PART#	PRICE
573	Gray Cloth	#11582.....	\$159.95
575	Blue Cloth	#11583.....	\$159.95
578	Gray Cloth.....	#11582.....	\$159.95
574	Green Cloth	#11584.....	\$159.95
577	Turquoise Cloth	#11585.....	\$159.95
617	Beige Cloth.....	#11586.....	\$159.95

Tack Strip Set

TRIM#	COLOR DESCRIPTION	DANCHUK PART#	PRICE
All	56 2-Dr. Sedan Tack Strips.....	#11312.....	\$40.95

Sunvisors (Pair) - Original Material

Sewn in napped cloth on new boards with new rods and chrome clips.

TRIM#	COLOR DESCRIPTION	DANCHUK PART#	PRICE
573	Gray Cloth	#11587.....	\$147.95
575	Blue Cloth	#12037.....	\$147.95
578	Gray Cloth.....	#11587.....	\$147.95
574	Green Cloth	#12038.....	\$147.95
577	Turquoise Cloth	#12039.....	\$147.95
617	Beige Cloth.....	#11588.....	\$147.95

Daytona Carpet-Original Style

Original tight weave Daytona, ready to install, with foam backing, correct heel pad and binding.

TRIM#	COLOR DESCRIPTION	DANCHUK PART#	PRICE
573	Black.....	#11995.....	\$458.95
575	Dark Blue.....	#11949.....	\$458.95
578	Black.....	#11995.....	\$458.95
574	Dark Green.....	#11953.....	\$458.95
577	Turquoise	#11951.....	\$458.95
617	Copper	#12008.....	\$458.95



1956 BEL AIR 4-DOOR SEDAN

Seat Covers - Front & Rear

Pre-sewn in heavyweight vinyl and correct pattern cloth, with all listings attached, ready to install. Set includes covers for front and rear seats and enough material to cover the seat caps.

TRIM#	COLOR DESCRIPTION	DANCHUK PART#	PRICE
573	Charcoal Pattern Cloth with Ivory Vinyl	#11589	\$768.95
575	Blue Pattern Cloth with Blue Vinyl.....	#11590	\$768.95
578	Charcoal Pattern Cloth with Yellow Vinyl.....	#11591	\$768.95
574	Green Pattern Cloth with Green Vinyl.....	#11592	\$768.95
577	Turquoise Pattern Cloth with Turquoise Vinyl ..	#11593	\$768.95
617	Copper Pattern Cloth with Beige Vinyl	#11594	\$768.95

Pre-Assembled Door Panels 4-Door

Pre-assembled front and rear door panels, in original style materials, on new boards with metal door edge bands attached. Front and rear armrests are pre-sewn into the door panels using new armrest pads. Includes windlace and kick panels. Stainless trim is available for an additional charge. Armrest bases included

TRIM#	COLOR DESCRIPTION	DANCHUK PART#	PRICE
573	Charcoal with Ivory Vinyl	#11595	\$968.95
575	Blue with Blue Vinyl	#11596	\$968.95
578	Charcoal with Yellow Vinyl	#11597	\$968.95
574	Green with Green Vinyl	#11598	\$968.95
577	Turquoise with Turquoise Vinyl	#11599	\$968.95
617	Copper with Beige Vinyl	#11600	\$968.95

Stainless Interior Door Panel Trim Kit

	DANCHUK PART#	PRICE
All	#11324	\$323.95

Please specify color of lower door scuff vinyl when ordering.

Front or Rear Armrest Bases

TRIM#	COLOR DESCRIPTION	DANCHUK PART#	PRICE
All	ABS Plastic Armrest Base, Per Pair.....	#11537	\$89.95

Front Armrest Rubber Pads

TRIM#	COLOR DESCRIPTION	DANCHUK PART#	PRICE
All	Front, Per Pair.....	#11427A	\$89.95

Headliner - Original Material

Pre-sewn napped cloth with visor and upper post material included.

TRIM#	COLOR DESCRIPTION	DANCHUK PART#	PRICE
573	Gray Cloth	#11582	\$159.95
575	Blue Cloth	#11583	\$159.95
578	Gray Cloth.....	#11582	\$159.95
574	Green Cloth	#11584	\$159.95
577	Turquoise Cloth	#11585	\$159.95
617	Beige Cloth.....	#11586	\$159.95

Glide front seat frames will incur an extra \$125 custom set-up fee.

Tack Strip Set

TRIM#	COLOR DESCRIPTION	DANCHUK PART#	PRICE
All	4-Dr. Sedan Tack Strips.....	#11314	\$51.95

Sunvisors (Pair) - Original Material

Sewn in napped cloth on new boards with new rods and chrome clips.

TRIM#	COLOR DESCRIPTION	DANCHUK PART#	PRICE
573	Gray Cloth	#11587	\$147.95
575	Blue Cloth	#12037	\$147.95
578	Gray Cloth.....	#11587	\$147.95
574	Green Cloth	#12038	\$147.95
577	Turquoise Cloth	#12039	\$147.95
617	Beige Cloth.....	#11588	\$147.95

Daytona Carpet - Original Style

Original tight weave Daytona, ready to install, with foam backing, correct heel pad and binding.

TRIM#	COLOR DESCRIPTION	DANCHUK PART#	PRICE
573	Black.....	#11999	\$458.95
575	Dark Blue.....	#11954	\$458.95
578	Black.....	#11999	\$458.95
574	Dark Green.....	#11958	\$458.95
577	Turquoise	#11956	\$458.95
617	Copper	#12009	\$458.95



1956 BEL AIR 4-DOOR WAGON 6 AND 9 PASSENGER

Seat Covers - Front & Rear (6-Passenger)

Pre-sewn in heavyweight vinyl and correct pattern cloth, with all listings attached, ready to install. Set includes covers for front and rear seats and enough material to cover the seat caps.

TRIM#	COLOR DESCRIPTION	DANCHUK PART#	PRICE
611	Charcoal Pattern Cloth with Ivory Vinyl.....	#11601.....	\$768.95
595	Charcoal Pattern Cloth with Yellow Vinyl.....	#11603.....	\$768.95
594	Beige/Turquoise Pattern Cloth with Turquoise Vinyl.....	#11605.....	\$768.95
620	Beige/Copper Pattern Cloth with Beige Vinyl..	#11606.....	\$768.95
593	Beige/Red Pattern Cloth with Red Vinyl.....	#11607.....	\$768.95

Seat Covers - Front, Middle, Rear (9-Passenger)

Pre-sewn in heavyweight vinyl and correct pattern cloth, with all listings attached, ready to install. Set includes covers for front, center and rear seats and enough material to cover the seat caps.

TRIM#	COLOR DESCRIPTION	DANCHUK PART#	PRICE
611	Charcoal Pattern Cloth with Ivory Vinyl.....	#11608.....	\$998.95
595	Charcoal Pattern Cloth with Yellow Vinyl.....	#11610.....	\$998.95
594	Beige/Turquoise Pattern Cloth with Turquoise Vinyl.....	#11612.....	\$998.95
620	Beige/Copper Pattern Cloth with Beige Vinyl..	#11613.....	\$998.95
593	Beige/Red Pattern Cloth with Red Vinyl.....	#11614.....	\$998.95

Pre-Assembled Door Panels 4-Door

Pre-assembled front and rear panels on new boards with metal door edge bands attached. Front armrests are pre-sewn to the front panels using new armrest pads. Includes windlace, kick panels, wheelwell covers, over the wheel well boards and material to cover armrests. Front armrest bases included

TRIM#	COLOR DESCRIPTION	DANCHUK PART#	PRICE
611	Charcoal with Ivory Vinyl.....	#11615.....	\$908.95
595	Charcoal with Yellow Vinyl.....	#11617.....	\$908.95
594	Turquoise with Turquoise Vinyl.....	#11619.....	\$908.95
620	Copper with Beige Vinyl.....	#11620.....	\$908.95
593	Beige with Red Vinyl.....	#11621.....	\$908.95

Front Armrest Bases

TRIM#	COLOR DESCRIPTION	DANCHUK PART#	PRICE
All	ABS Plastic Armrest Base, Per Pair.....	#11537.....	\$89.95

Front Armrest Rubber Pads

TRIM#	COLOR DESCRIPTION	DANCHUK PART#	PRICE
All	Front, Per Pair.....	#11427A.....	\$89.95

Glide front seat frames will incur an extra \$125 custom set-up fee.

Headliner - Original Material

Pre-sewn perforated vinyl with visor material included.

TRIM#	COLOR DESCRIPTION	DANCHUK PART#	PRICE
611	Ivory Perforated Vinyl.....	#11622.....	\$198.95
595	Yellow Perforated Vinyl.....	#11624.....	\$198.95
594	Turquoise Perforated Vinyl.....	#11626.....	\$198.95
620	Beige Perforated Vinyl.....	#11627.....	\$198.95
593	Beige Perforated Vinyl.....	#11627.....	\$198.95

Tack Strip Set

TRIM#	COLOR DESCRIPTION	DANCHUK PART#	PRICE
All	4-Dr. Wagon Tack Strip Set.....	#11316.....	\$53.95

Sunvisors (Pair) - Original Material

Sewn in perforated vinyl on new boards with new rods and chrome clips.

TRIM#	COLOR DESCRIPTION	DANCHUK PART#	PRICE
611	Ivory Perforated Vinyl.....	#11544.....	\$147.95
595	Yellow Perforated Vinyl.....	#11547.....	\$147.95
594	Turquoise Perforated Vinyl.....	#11545.....	\$147.95
620	Beige Perforated Vinyl.....	#11544.....	\$147.95
593	Beige Perforated Vinyl.....	#11544.....	\$147.95

Daytona Carpet - Original Style

Original tight weave Daytona, ready to install, with foam backing, correct heel pad and binding.

TRIM#	COLOR DESCRIPTION	DANCHUK PART#	PRICE
611	Black.....	#12000.....	\$458.95
595	Black.....	#12000.....	\$458.95
594	Turquoise.....	#12011.....	\$458.95
620	Copper.....	#12012.....	\$458.95
593	Red.....	#11966.....	\$458.95

Cargo Area Carpet (6 Passenger)

Cargo area carpet (Daytona) to replace the original linoleum.

TRIM#	COLOR DESCRIPTION	DANCHUK PART#	PRICE
611	Black.....	#12013.....	\$312.95
595	Black.....	#12013.....	\$312.95
594	Turquoise.....	#12016.....	\$312.95
620	Copper.....	#12017.....	\$312.95
593	Red.....	#12018.....	\$312.95



1956 CONVERTIBLE

Seat Covers - Front & Rear

Pre-sewn in heavyweight plain and fleck pattern vinyl, with all listings attached, ready to install. Set includes covers for front and rear seats and enough material to cover the seat caps.

TRIM#	COLOR DESCRIPTION	DANCHUK PART#	PRICE
602	Charcoal and Ivory Vinyl.....	#11630.....	\$768.95
605	Red and Ivory Vinyl.....	#11631.....	\$768.95
603	Turquoise and Ivory Vinyl.....	#11632.....	\$768.95
606	Medium Green and Light Green Vinyl.....	#11633.....	\$768.95
604	Charcoal and Yellow Vinyl.....	#11634.....	\$768.95
607	Dark and Light Blue Vinyl.....	#11635.....	\$768.95
621	Copper and Beige Vinyl.....	#11636.....	\$768.95

Pre-Assembled Door Panels - 2-Door

Pre-assembled front and rear upper panels, in original style materials, on new boards with metal door edge bands attached. Front armrests are pre-sewn to the front panels using new armrest pads. Includes windlace, kick panels and sewn rear armrest and piston covers. Stainless trim is available for an additional charge. Armrest bases included.

TRIM#	COLOR DESCRIPTION	DANCHUK PART#	PRICE
602	Charcoal and Ivory Vinyl.....	#11637.....	\$838.95
605	Red and Ivory Vinyl.....	#11638.....	\$838.95
603	Turquoise and Ivory Vinyl.....	#11639.....	\$838.95
606	Medium Green and Light Green Vinyl.....	#11640.....	\$838.95
604	Charcoal and Yellow Vinyl.....	#11641.....	\$838.95
607	Dark and Light Blue Vinyl.....	#11642.....	\$838.95
621	Copper and Beige Vinyl.....	#11643.....	\$838.95

Stainless Interior Door Panel Trim Kit

	DANCHUK PART#	PRICE
All	#2038.....	\$324.95

Front Armrest Bases

TRIM#	COLOR DESCRIPTION	DANCHUK PART#	PRICE
All	Plastic Armrest Bases, Per Pair.....	#11537.....	\$89.95

Front Armrest Rubber Pads

TRIM#	COLOR DESCRIPTION	DANCHUK PART#	PRICE
All	Front, Per Pair.....	#11427A.....	\$89.95

Front Door Handle Cup

TRIM#	COLOR DESCRIPTION	DANCHUK PART#	PRICE
All	Metal Cup for Front Armrest.....	#11300.....	\$15.95

Convertible Top Header Strips

TRIM#	COLOR DESCRIPTION	DANCHUK PART#	PRICE
All	Convertible Top Header Strips.....	#1523.....	\$76.95

Convertible Top Tack Strips

TRIM#	COLOR DESCRIPTION	DANCHUK PART#	PRICE
All	Convertible Top Tack Strips.....	#1521.....	\$34.95

Convertible Top

Made from 36 oz. GM pinpoint vinyl with plastic back window, sewn as original. Top and junior side pads are included.

TRIM#	COLOR DESCRIPTION	DANCHUK PART#	PRICE
White	#11452.....	\$498.95
Black.....	#11451.....	\$498.95
Beige	#11453.....	\$498.95

Sunvisors (Pair) - Original Material

Sewn in correct vinyl on new boards with new rods and chrome clips.

TRIM#	COLOR DESCRIPTION	DANCHUK PART#	PRICE
602	Black Vinyl.....	#11461.....	\$147.95
605	Red Vinyl.....	#11455.....	\$147.95
603	Turquoise Vinyl.....	#11644.....	\$147.95
606	Dark Green Vinyl.....	#11645.....	\$147.95
604	Black Vinyl.....	#11461.....	\$147.95
607	Dark Blue Vinyl.....	#11646.....	\$147.95
621	Copper Vinyl.....	#11647.....	\$147.95

Top Well Liner

Correctly sewn and ready to install.

TRIM#	COLOR DESCRIPTION	DANCHUK PART#	PRICE
All	Black.....	#11462.....	\$79.95
All	Beige.....	#11628.....	\$89.95
All	Turquoise.....	#11629.....	\$89.95

Convertible Top Boot Covers

Pre-sewn in vinyl, complete with Naugastay stiffener and snaps (not installed).

TRIM#	COLOR DESCRIPTION	DANCHUK PART#	PRICE
602	Ivory Vinyl.....	#11466.....	\$255.95
605	Ivory Vinyl.....	#11466.....	\$255.95
603	Light Turquoise Vinyl.....	#11648.....	\$255.95
606	Light Green Vinyl.....	#11649.....	\$255.95
604	Yellow Vinyl.....	#11650.....	\$255.95
607	Light Blue Vinyl.....	#11651.....	\$255.95
621	Beige Vinyl.....	#11463.....	\$255.95
Option	Black.....	#11468.....	\$255.95

Daytona Carpet - Original Style

Original tight weave Daytona, ready to install, with foam backing, correct heel pad and binding.

TRIM#	COLOR DESCRIPTION	DANCHUK PART#	PRICE
602	Black.....	#12019.....	\$458.95
605	Red.....	#11969.....	\$458.95
603	Turquoise.....	#11974.....	\$458.95
606	Dark Green.....	#11972.....	\$458.95
604	Black.....	#12019.....	\$458.95
607	Dark Blue.....	#11970.....	\$458.95
621	Copper.....	#12020.....	\$458.95

Glide front seat frames will incur an extra \$125 custom set-up fee.



1956 NOMAD

Seat Covers - Front and Rear

Pre-sewn in heavyweight vinyl and correct pattern cloth, with all listings attached, ready to install. Set includes covers for front and rear seats and enough material to cover the seat caps.

TRIM#	COLOR DESCRIPTION	DANCHUK PART#	PRICE
590	Beige/Green Pattern Cloth w/Lt. Green Vinyl ..	#11652	\$768.95
591	Beige/Blue Pattern Cloth with Lt. Blue Vinyl ...	#11653	\$768.95
593	Beige/Red Pattern Cloth with Red Vinyl.....	#11654	\$768.95
595	Charcoal Pattern Cloth with Yellow Vinyl.....	#11655	\$768.95
611	Charcoal Pattern Cloth with Ivory Vinyl	#11656	\$768.95
620	Beige/Copper Pattern Cloth w/Copper Vinyl...	#11657	\$768.95
594	Beige/Turquoise Cloth with Lt. Turquoise Vinyl#11658.....	#11658	\$768.95

Pre-Assembled Door Panels - 2-Door

Pre-assembled front and rear panels on new boards with metal door edge bands attached. Front armrests are pre-sewn to the front panels using new armrest pads. Includes windlace, kick panels, wheelwell covers, over the wheel well boards and material to cover armrests. Stainless trim is available for an additional charge. Armrest bases included.

TRIM#	COLOR DESCRIPTION	DANCHUK PART#	PRICE
590	Green with Lt. Green Vinyl	#11659	\$908.95
591	Blue with Lt. Blue Vinyl	#11660	\$908.95
593	Beige with Red Vinyl	#11661	\$908.95
595	Charcoal with Yellow Vinyl	#11662	\$908.95
611	Charcoal with Ivory Vinyl	#11663	\$908.95
620	Beige with Copper Vinyl	#11664	\$908.95
594	Turquoise with Lt. Turquoise Vinyl	#11665	\$908.95

Stainless Interior Door Panel Trim Kit

	DANCHUK PART#	PRICE
All	#2040	\$345.95

Front Armrest Bases

TRIM#	COLOR DESCRIPTION	DANCHUK PART#	PRICE
All	Plastic Armrest Bases	#11537	\$89.95

Front Armrest Rubber Pads

TRIM#	COLOR DESCRIPTION	DANCHUK PART#	PRICE
All	Front, Per Pair	#11427A	\$89.95

Front Door Handle Cup

TRIM#	COLOR DESCRIPTION	DANCHUK PART#	PRICE
All	Metal Cup for Front Armrest	#11300	\$15.95

Glide front seat frames will incur an extra \$125 custom set-up fee.

Headliner - Original Material

Pre-sewn vinyl with visor material included.

TRIM#	COLOR DESCRIPTION	DANCHUK PART#	PRICE
590	Green	#11666	\$198.95
591	Blue.....	#11667	\$198.95
593	Beige.....	#11483	\$198.95
595	Yellow.....	#11668	\$198.95
611	Ivory.....	#11484	\$198.95
620	Beige.....	#11483	\$198.95
594	Turquoise	#11669	\$198.95

Tack Strip Set

TRIM#	COLOR DESCRIPTION	DANCHUK PART#	PRICE
All	Nomad Headliner Tack Strip Set	#11310	\$77.95

Sunvisors (Pair)

Sewn in original material on new boards with new rods and chrome clips.

TRIM#	COLOR DESCRIPTION	DANCHUK PART#	PRICE
590	Green	#11546	\$147.95
591	Blue.....	#11548	\$147.95
593	Beige.....	#11486	\$147.95
595	Yellow.....	#11547	\$147.95
611	Ivory.....	#11487	\$147.95
620	Beige.....	#11486	\$147.95
594	Turquoise	#11545	\$147.95

Daytona Carpet - Original Style

Original tight weave Daytona, ready to install, with foam backing, correct heel pad and binding.

TRIM#	COLOR DESCRIPTION	DANCHUK PART#	PRICE
590	Green, Dark.....	#16577	\$458.95
591	Blue, Dark	#12021	\$458.95
593	Red	#11980	\$458.95
595	Black	#12022	\$458.95
611	Black.....	#12022	\$458.95
620	Copper.....	#12023	\$458.95
594	Turquoise	#11977	\$458.95

Daytona Cargo Area Carpet

Cargo area carpet (Daytona) to replace the original linoleum.

TRIM#	COLOR DESCRIPTION	DANCHUK PART#	PRICE
590	Green, Dark.....	#12015	\$312.95
591	Blue, Dark	#12014	\$312.95
593	Red	#12018	\$312.95
595	Black.....	#12013	\$312.95
611	Black.....	#12013	\$312.95
620	Copper.....	#12017	\$312.95
594	Turquoise	#12016	\$312.95



1956 210 2-DOOR SEDAN

Seat Covers - Front & Rear

Pre-sewn in patterned bar and mylar cloth and substitute plain ivory vinyl (original "Starfrost" vinyl is not available), with all listings attached, ready to install. Set includes covers for front and rear seats and enough material to cover the seat caps.

TRIM#	COLOR DESCRIPTION	DANCHUK PART#	PRICE
564	Charcoal Cloth and Ivory Vinyl	#11670.....	\$658.95
565	Green Cloth and Ivory Vinyl	#11671.....	\$658.95
566	Blue Cloth and Ivory Vinyl.....	#11672.....	\$658.95

Pre-Assembled Door Panels - 2-Door

Pre-Assembled front and rear panels, in original style materials, on new boards with metal door edge bands attached. Includes windlace, kick panels and enough material to cover the armrests. Stainless trim is available for an additional charge.

TRIM#	COLOR DESCRIPTION	DANCHUK PART#	PRICE
564	Charcoal Cloth and Ivory Vinyl	#11673.....	\$778.95
565	Green Cloth and Ivory Vinyl	#11674.....	\$778.95
566	Blue Cloth and Ivory Vinyl.....	#11675.....	\$778.95

Stainless Interior Door Panel Trim Kit

	DANCHUK PART#	PRICE
All	#11323.....	\$208.95

Headliner - Original Material

Pre-sewn napped cloth with visor material included.

TRIM#	COLOR DESCRIPTION	DANCHUK PART#	PRICE
564	Gray	#11582.....	\$159.95
565	Green	#11584.....	\$159.95
566	Blue	#11583.....	\$159.95

Tack Strips

TRIM#	COLOR DESCRIPTION	DANCHUK PART#	PRICE
All	2-Dr. Sedan Tack Strips.....	#11312.....	\$40.95

Sunvisors (Pair) - Original Material

Sewn in napped cloth on new boards with new rods and chrome clips.

TRIM#	COLOR DESCRIPTION	DANCHUK PART#	PRICE
564	Gray	#12042.....	\$147.95
565	Green	#12043.....	\$147.95
566	Blue.....	#12044.....	\$147.95

Daytona Carpet - Original Style

Original tight weave Daytona, ready to install, with foam backing, correct heel pad and binding.

TRIM#	COLOR DESCRIPTION	DANCHUK PART#	PRICE
564	Black.....	#11995.....	\$458.95
565	Light Green	#11984.....	\$458.95
566	Light Blue	#11983.....	\$458.95

Glide front seat frames will incur an extra \$125 custom set-up fee.



1956 210 4-DOOR SEDAN

Seat Covers - Front & Rear

Reproduction cloth seat inserts, saddle stitched to matching plain trim vinyls (Starfrost vinyl not available). Listing attached for easy installation. Seat shell vinyl included.

TRIM#	COLOR DESCRIPTION	DANCHUK PART#	PRICE
564	Charcoal Cloth and Ivory Vinyl	#11676.....	\$658.95
565	Green Cloth and Ivory Vinyl	#11677.....	\$658.95
566	Blue Cloth and Ivory Vinyl.....	#11678.....	\$658.95

Pre-Assembled Door Panels - 4-Door

Pre-assembled door and rear upper quarter panels. These include new boards, metal door edge bands and original style materials attached. Also includes sewn windlace, front and rear armrest vinyl and kick panels. Stainless trim not included.

TRIM#	COLOR DESCRIPTION	DANCHUK PART#	PRICE
564	Charcoal Cloth and Ivory Vinyl	#11679.....	\$818.95
565	Green Cloth and Ivory Vinyl	#11680.....	\$818.95
566	Blue Cloth and Ivory Vinyl.....	#11681.....	\$818.95

Tack Strips

TRIM#	COLOR DESCRIPTION	DANCHUK PART#	PRICE
All	4-Dr. Sedan Tack Strips.....	#11314.....	\$51.95

Headliner - Original Material

Pre-sewn napped cloth with visor material included.

TRIM#	COLOR DESCRIPTION	DANCHUK PART#	PRICE
564	Gray	#11582.....	\$159.95
565	Green	#11584.....	\$159.95
566	Blue	#11583.....	\$159.95

Sunvisors (Pair) - Original Material

Sewn in napped cloth on new boards with new rods and chrome clips.

TRIM#	COLOR DESCRIPTION	DANCHUK PART#	PRICE
564	Gray	#12042.....	\$147.95
565	Green	#12043.....	\$147.95
566	Blue.....	#12044.....	\$147.95

Daytona Carpet - Original Style

Original tight weave Daytona, ready to install, with foam backing, correct heel pad and binding.

TRIM#	COLOR DESCRIPTION	DANCHUK PART#	PRICE
564	Black.....	#11999.....	\$458.95
565	Light Green	#11992.....	\$458.95
566	Light Blue	#11991.....	\$458.95

1956 210 2-DOOR HARDTOP

Seat Covers - Front & Rear

Pre-sewn in patterned bar and mylar cloth and substitute plain ivory vinyl (original "Starfrost" vinyl is not available), with all listings attached, ready to install. Set includes covers for front and rear seats and enough material to cover the seat caps.

TRIM#	COLOR DESCRIPTION	DANCHUK PART#	PRICE
564	Charcoal Cloth and Ivory Vinyl, 6-Passenger..	#11689.....	\$658.95
565	Green Cloth and Ivory Vinyl, 6-Passenger.....	#11690.....	\$658.95
566	Blue Cloth and Ivory Vinyl, 6-Passenger	#11691.....	\$658.95

Pre-Assembled Door Panels

Pre-Assembled front and rear upper panels, in original style materials, on new boards with metal door edge bands attached. Includes windlace, kick panels, material to cover the front armrests and sewn rear arm rest covers. Stainless trim is available for an additional charge.

TRIM#	COLOR DESCRIPTION	DANCHUK PART#	PRICE
564	Charcoal Cloth and Ivory Vinyl	#11692.....	\$758.95
565	Green Cloth and Ivory Vinyl	#11693.....	\$758.95
566	Blue Cloth and Ivory Vinyl.....	#11694.....	\$778.95

Stainless Interior Door Panel Trim Kit

	DANCHUK PART#	PRICE
All	Stainless Interior Door Panel Trim Kit.....	#11321.....\$208.95

Tack Strip Set

TRIM#	COLOR DESCRIPTION	DANCHUK PART#	PRICE
All	2-Dr. Hardtop Headliner Tack Strips.....	#11309.....	\$59.95

Headliner - Original Material

Pre-sewn napped cloth with visor material included.

TRIM#	COLOR DESCRIPTION	DANCHUK PART#	PRICE
564	Gray	#11695.....	\$169.95
565	Green	#11696.....	\$159.95
566	Blue	#11697.....	\$159.95

Sunvisors (Pair) - Original Material

Sewn in napped cloth on new boards with new rods and chrome clips.

TRIM#	COLOR DESCRIPTION	DANCHUK PART#	PRICE
564	Gray	#12042.....	\$147.95
565	Green	#12043.....	\$147.95
566	Blue.....	#12044.....	\$147.95

Daytona Carpet - Original Style

Original tight weave Daytona, ready to install, with foam backing, correct heel pad and binding.

TRIM#	COLOR DESCRIPTION	DANCHUK PART#	PRICE
564	Black.....	#11964.....	\$458.95
565	Light Green	#11963.....	\$458.95
566	Light Blue	#11959.....	\$458.95

Glide front seat frames will incur an extra \$125 custom set-up fee.

WARNING! Products on these pages may contain chemicals known to the State Of California to cause cancer and/or birth defects or reproductive harm. www.p65warnings.ca.gov

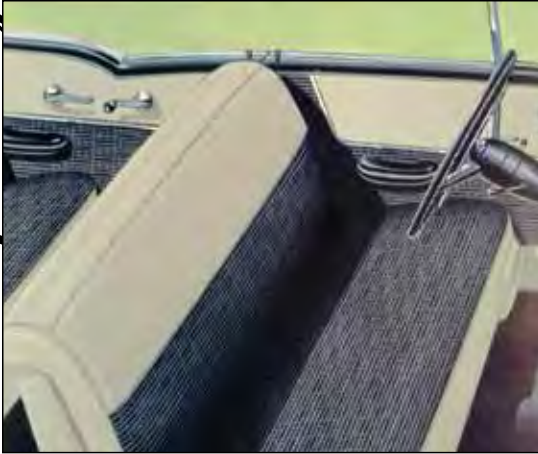

1956 DEL RAY 2-DOOR SEDAN

Seat Covers - Front & Rear

Pre-sewn heavy weight vinyl in correct saddle stitched block design, listings attached, ready to install. Set includes covers for front and rear seats and enough material to cover the seat caps.

TRIM#	COLOR DESCRIPTION	DANCHUK PART#	PRICE
567	Black and Ivory Vinyl	#11682	\$768.95
568	Green and Ivory Vinyl	#11683	\$768.95
569	Turquoise and Ivory Vinyl	#11684	\$768.95

Pre-Assembled Door Panels - 2-Door

Pre-assembled front and rear panels, in original style materials, on new boards with metal door edge bands attached. Includes windlace, kick panels and enough material to cover the armrests. Stainless trim is available for an additional charge.

TRIM#	COLOR DESCRIPTION	DANCHUK PART#	PRICE
567	Black and Ivory Vinyl	#11685	\$778.95
568	Green and Ivory Vinyl	#11686	\$778.95
569	Turquoise and Ivory Vinyl	#11687	\$778.95

Stainless Interior Door Panel Trim Kit

	DANCHUK PART#	PRICE
All	#11320	\$182.95

1956 210 4-DOOR HARDTOP

Seat Covers - Front & Rear

Pre-sewn in patterned bar and mylar cloth and substitute plain ivory vinyl (original "Starfrost" vinyl is not available), with all listings attached, ready to install. Set includes covers for front and rear seats and enough material to cover the seat caps.

TRIM#	COLOR DESCRIPTION	DANCHUK PART#	PRICE
564	Charcoal Cloth and Ivory Vinyl	#11698	\$658.95
565	Green Cloth and Ivory Vinyl	#11699	\$658.95
566	Blue Cloth and Ivory Vinyl	#11700	\$658.95

Pre-Assembled Door Panels - 4-Door

Pre-Assembled front and rear door panels, in original style materials, on new boards with metal door edge bands attached. Includes windlace, kick panels, material to cover the armrests. Stainless trim is available for an additional charge.

TRIM#	COLOR DESCRIPTION	DANCHUK PART#	PRICE
564	Charcoal Cloth and Ivory Vinyl	#11701	\$818.95
565	Green Cloth and Ivory Vinyl	#11702	\$818.95
566	Blue Cloth and Ivory Vinyl	#11703	\$818.95

Stainless Interior Door Panel Trim Kit

	DANCHUK PART#	PRICE
All	#11322	\$208.95

Headliner - Original Material

Pre-sewn perforated vinyl with visor material included.

TRIM#	COLOR DESCRIPTION	DANCHUK PART#	PRICE
567	Ivory Perforated Vinyl	#11688	\$168.95
568	Ivory Perforated Vinyl	#11688	\$168.95
569	Ivory Perforated Vinyl	#11688	\$168.95

Tack Strips

TRIM#	COLOR DESCRIPTION	DANCHUK PART#	PRICE
All	2-Dr. Sedan Tack Strips	#11312	\$40.95

Sunvisors (Pair) - Original Material

Sewn in perforated vinyl on new boards with new rods and chrome clips.

TRIM#	COLOR DESCRIPTION	DANCHUK PART#	PRICE
567	Ivory Perforated	#12045	\$147.95
568	Ivory Perforated	#12045	\$147.95
569	Ivory Perforated	#12045	\$147.95

Daytona Carpet - Original Style

Original tight weave Daytona, ready to install, with foam backing, correct heel pad and binding.

TRIM#	COLOR DESCRIPTION	DANCHUK PART#	PRICE
564	Black	#11995	\$458.95
565	Green, Light	#11984	\$458.95
566	Turquoise	#11951	\$458.95

Headliner - Original Material

Pre-sewn napped cloth with visor material included.

TRIM#	COLOR DESCRIPTION	DANCHUK PART#	PRICE
564	Gray	#11704	\$159.95
565	Green	#11705	\$159.95
566	Blue	#11706	\$159.95

Sunvisors (Pair) - Original Material

Sewn in napped cloth on new boards with new rods and chrome clips.

TRIM#	COLOR DESCRIPTION	DANCHUK PART#	PRICE
564	Gray	#12042	\$147.95
565	Green	#12043	\$147.95
566	Blue	#12044	\$147.95

Daytona Carpet - Original Style

Original tight weave Daytona, ready to install, with foam backing, correct heel pad and binding.

TRIM#	COLOR DESCRIPTION	DANCHUK PART#	PRICE
564	Black	#12002	\$458.95
565	Light Green	#12004	\$458.95
566	Light Blue	#12005	\$458.95

Glide front seat frames will incur an extra \$125 custom set-up fee.



1956 210 2-DOOR WAGON

Seat Covers - Front & Rear

Pre-sewn in patterned bar and mylar cloth and substitute plain ivory vinyl (original "Starfrost" vinyl is not available), with all listings attached, ready to install. Set includes covers for front and rear seats and enough material to cover the seat caps.

TRIM#	COLOR DESCRIPTION	DANCHUK PART#	PRICE
564	Charcoal and Ivory Vinyl	#11707	\$658.95
565	Green and Ivory Vinyl	#11708	\$658.95

Pre-Assembled Door Panels - 2-Door

Pre-assembled front and rear panels on new boards with metal door edge bands attached. Includes windlace, kick panels, wheelwell covers, over the wheel well boards and material to cover the armrests.

TRIM#	COLOR DESCRIPTION	DANCHUK PART#	PRICE
564	Charcoal and Ivory Vinyl	#11709	\$778.95
565	Green and Ivory Vinyl	#11710	\$778.95

Headliner - Original Material

Pre-sewn vinyl with visor material included.

TRIM#	COLOR DESCRIPTION	DANCHUK PART#	PRICE
564	Gray	#11522	\$198.95
565	Green	#11715	\$198.95

Tack Strips

TRIM#	COLOR DESCRIPTION	DANCHUK PART#	PRICE
All	2-Dr. Wagon Tack Strips	#11315	\$59.95

Sunvisors (Pair) - Original Material

Sewn in vinyl on new boards with new rods and chrome clips.

TRIM#	COLOR DESCRIPTION	DANCHUK PART#	PRICE
564	Gray	#15516	\$147.95
565	Green	#14560	\$147.95

Daytona Carpet - Original Style

Original tight weave Daytona, ready to install, with foam backing, correct heel pad and binding.

TRIM#	COLOR DESCRIPTION	DANCHUK PART#	PRICE
564	Black	#12022	\$458.95
565	Dark Green	#16577	\$458.95

Daytona Cargo Area Carpet

Cargo area carpet (Daytona) to replace the original linoleum.

TRIM#	COLOR DESCRIPTION	DANCHUK PART#	PRICE
564	Black	#12013	\$312.95
565	Dark Green	#14086	\$279.95

1956 210 4-DOOR WAGON

Seat Covers - Front & Rear

Pre-sewn in patterned bar and mylar cloth and substitute plain ivory vinyl (original "Starfrost" vinyl is not available), with all listings attached, ready to install. Set includes covers for front and rear seats and enough material to cover the seat caps.

TRIM#	COLOR DESCRIPTION	DANCHUK PART#	PRICE
564	Charcoal and Ivory Vinyl	#11711	\$658.95
565	Green and Ivory Vinyl	#11712	\$658.95

Pre-Assembled Door Panels

Pre-assembled front and rear panels on new boards with metal door edge bands attached. Includes windlace, kick panels, wheelwell covers, over the wheel well boards and material to cover the armrests.

TRIM#	COLOR DESCRIPTION	DANCHUK PART#	PRICE
564	Charcoal and Ivory Vinyl	#11713	\$818.95
565	Green and Ivory Vinyl	#11714	\$818.95

Headliner - Original Material

Pre-sewn vinyl with visor material included.

TRIM#	COLOR DESCRIPTION	DANCHUK PART#	PRICE
564	Gray	#11522	\$198.95
565	Green	#11715	\$198.95

Tack Strips

TRIM#	COLOR DESCRIPTION	DANCHUK PART#	PRICE
All	4-Dr. Wagon Tack Strips	#11316	\$53.95

Sunvisors (Pair) - Original Material

Sewn in vinyl on new boards with new rods and chrome clips.

TRIM#	COLOR DESCRIPTION	DANCHUK PART#	PRICE
564	Gray	#12042	\$147.95
565	Green	#14560	\$147.95

Daytona Carpet - Original Style

Original tight weave Daytona, ready to install, with foam backing, correct heel pad and binding.

TRIM#	COLOR DESCRIPTION	DANCHUK PART#	PRICE
564	Black	#12000	\$458.95
565	Dark Green	#11997	\$458.95

Daytona Cargo Area Carpet

Cargo area carpet (Daytona) to replace the original linoleum.

TRIM#	COLOR DESCRIPTION	DANCHUK PART#	PRICE
564	Black	#14083	\$279.95
565	Dark Green	#14086	\$279.95

Glide front seat frames will incur an extra \$125 custom set-up fee.

WARNING! Products on these pages may contain chemicals known to the State Of California to cause cancer and/or birth defects or reproductive harm. www.p65warnings.ca.gov

1956 150 2-DOOR SEDAN

Seat Covers - Front & Rear

Pre-sewn in heavyweight vinyl and correct black shell-pattern with beige dot cloth, listings attached, ready to install. Set includes covers for front and rear seats and enough material to cover the seat caps.

TRIM#	COLOR DESCRIPTION	DANCHUK PART#	PRICE
560	Black Cloth and Beige Vinyl	#11716	\$768.95

Pre-Assembled Door Panels - 2-Door

Pre-assembled front and rear panels, in original style materials, on new boards with metal door edge bands attached. Includes windlace, kick panels and enough material to cover the armrests.

TRIM#	COLOR DESCRIPTION	DANCHUK PART#	PRICE
560	Black Cloth and Beige Vinyl	#11717	\$778.95

Headliner - Original Material

Pre-sewn napped cloth with visor material included.

TRIM#	COLOR DESCRIPTION	DANCHUK PART#	PRICE
560	Beige	#12040	\$159.95

1956 150 4-DOOR SEDAN

Seat Covers - Front & Rear

Pre-sewn in heavyweight vinyl and correct black shell-pattern with beige dot cloth, listings attached, ready to install. Set includes covers for front and rear seats and enough material to cover the seat caps.

TRIM#	COLOR DESCRIPTION	DANCHUK PART#	PRICE
560	Black Cloth and Beige Vinyl	#11718	\$768.95

Pre-Assembled Door Panels - 4-Door

Pre-assembled front and rear door panels with new rear upper panels, in original style materials, on new boards with metal door edge bands attached. Includes windlace, kick panels and enough material to cover the armrests.

TRIM#	COLOR DESCRIPTION	DANCHUK PART#	PRICE
560	Black Cloth and Beige Vinyl	#11719	\$818.95

Headliner - Original Material

Pre-sewn napped cloth with visor material included.

TRIM#	COLOR DESCRIPTION	DANCHUK PART#	PRICE
560	Beige	#12040	\$159.95

1956 150 2-DOOR WAGON

Seat Covers - Front & Rear

Pre-sewn in heavyweight vinyl and correct black shell-pattern with beige dot cloth, listings attached, ready to install. Set includes covers for front and rear seats and enough material to cover the seat caps.

TRIM#	COLOR DESCRIPTION	DANCHUK PART#	PRICE
560	Black Cloth and Beige Vinyl	#16570	\$768.95

Pre-Assembled Door Panels - 2-Door

Pre-assembled front and rear panels on new boards with metal door edge bands attached. Includes windlace, kick panels, wheelwell covers, over the wheel well boards and material to cover the armrests.

TRIM#	COLOR DESCRIPTION	DANCHUK PART#	PRICE
560	Black Cloth and Beige Vinyl	#16569	\$828.95

Headliner - Original Material

Pre-sewn vinyl with visor material included.

TRIM#	COLOR DESCRIPTION	DANCHUK PART#	PRICE
560	Beige	#11515	\$198.95

Tack Strips

TRIM#	COLOR DESCRIPTION	DANCHUK PART#	PRICE
All	2-Dr. Sedan Tack Strips	#11312	\$40.95

Sunvisors (Pair) - Original Material

Sewn in napped cloth on new boards with new rods and chrome clips.

TRIM#	COLOR DESCRIPTION	DANCHUK PART#	PRICE
560	Beige	#12041	\$147.95

Daytona Carpet - Original Style

Original tight weave Daytona, ready to install, with foam backing, correct heel pad and binding.

TRIM#	COLOR DESCRIPTION	DANCHUK PART#	PRICE
560	Black	#11995	\$458.95

Tack Strips

TRIM#	COLOR DESCRIPTION	DANCHUK PART#	PRICE
All	4-Dr. Sedan Tack Strips	#11313	\$41.95

Sunvisors (Pair) - Original Material

Sewn in napped cloth on new boards with new rods and chrome clips.

TRIM#	COLOR DESCRIPTION	DANCHUK PART#	PRICE
560	Beige	#12041	\$147.95

Daytona Carpet - Original Style

Original tight weave Daytona, ready to install, with foam backing, correct heel pad and binding.

TRIM#	COLOR DESCRIPTION	DANCHUK PART#	PRICE
560	Black	#11999	\$458.95

Tack Strips

TRIM#	COLOR DESCRIPTION	DANCHUK PART#	PRICE
All	2-Dr. Wagon Tack Strips	#11315	\$59.95

Sunvisors (Pair) - Original Material

Sewn in vinyl on new boards with new rods and chrome clips.

TRIM#	COLOR DESCRIPTION	DANCHUK PART#	PRICE
560	Beige	#12041	\$147.95

Daytona Carpet - Original Style

Original tight weave Daytona, ready to install, with foam backing, correct heel pad and binding.

TRIM#	COLOR DESCRIPTION	DANCHUK PART#	PRICE
560	Black	#12022	\$458.95

Daytona Cargo Area Carpet

Cargo area carpet (Daytona) to replace the original linoleum.

TRIM#	COLOR DESCRIPTION	DANCHUK PART#	PRICE
560	Black	#14083	\$279.95

Glide front seat frames will incur an extra \$125 custom set-up fee.

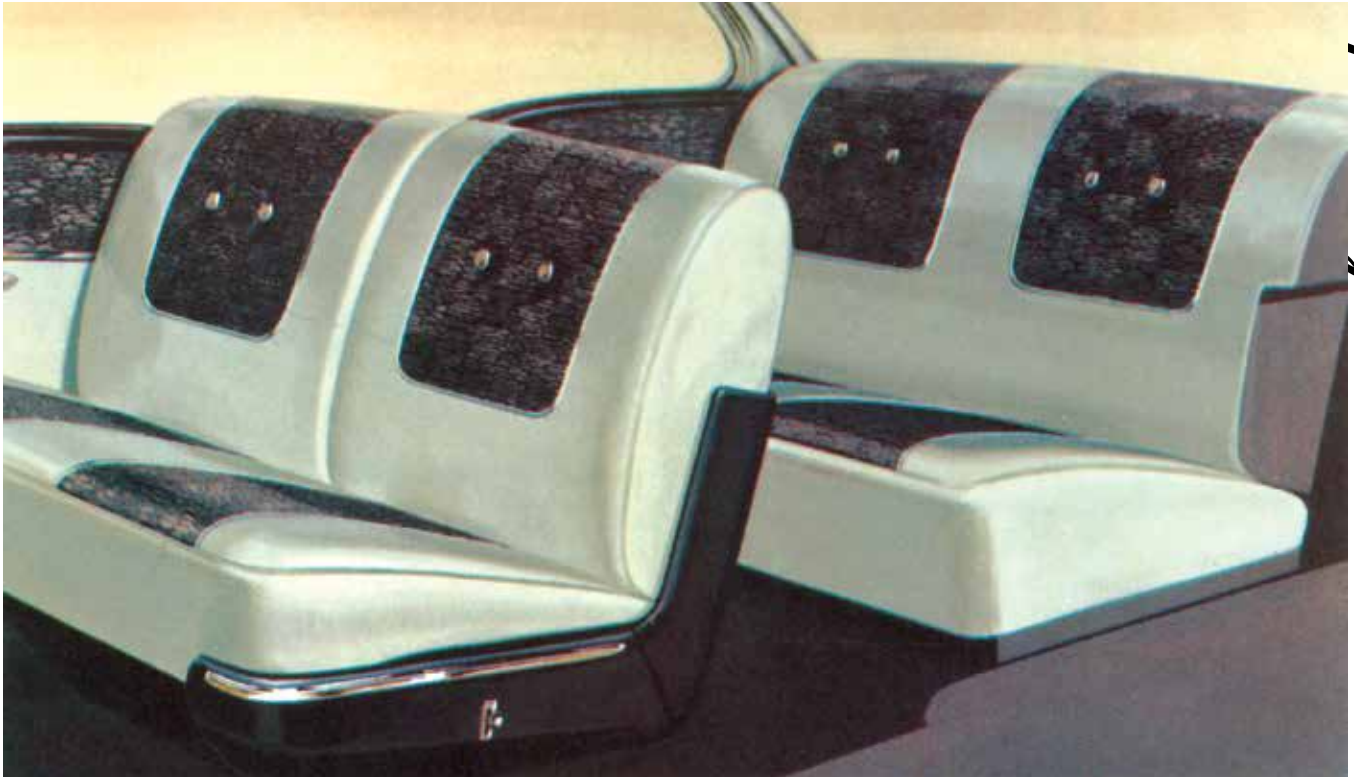

1957 BEL AIR 2-DOOR HARDTOP

Seat Covers - Front & Rear

Pre-sewn in heavyweight vinyl and "cloud pattern" cloth with seat buttons, listings attached, ready to install. Set includes covers for front and rear seats and enough material to cover the seat caps.

TRIM#	COLOR DESCRIPTION	DANCHUK PART#	PRICE
670	Black & Silver Cloud Patterned Cloth w/Silver Vinyl ...	#11720	\$718.95
671	Black & Green Cloud Patterned Cloth w/Green Vinyl .	#11721	\$718.95
672	Black & Blue Cloud Patterned Cloth with Blue Vinyl...	#11722	\$718.95
673	Black & Turq. Cloud Patterned Cloth with Turq. Vinyl.	#11723	\$718.95
674	Black & Copper Cloud Patterned Cloth w/Beige Vinyl	#11724	\$718.95
675	Black & Yellow Cloud Patterned Cloth w/Yellow Vinyl	#11725	\$718.95
676	Black & Red Cloud Patterned Cloth w/Red Vinyl.....	#11726	\$718.95

Pre-Assembled Door Panels - 2-Door

Pre-assembled front and rear upper panels, in original style materials, on new boards with metal door edge bands attached. Includes windlace, kick panels, material to cover the front armrests and sewn rear arm rest covers. Stainless trim is available for an additional charge.

TRIM#	COLOR DESCRIPTION	DANCHUK PART#	PRICE
670	Black & Silver Cloud Patterned Cloth w/Silver Vinyl ...	#11727	\$728.95
671	Black & Green Cloud Patterned Cloth w/Green Vinyl .	#11728	\$728.95
672	Black & Blue Cloud Patterned Cloth w/Blue Vinyl.....	#11729	\$728.95
673	Black & Turq. Cloud Patterned Cloth w/Turq. Vinyl.....	#11730	\$728.95
674	Black & Copper Cloud Patterned Cloth w/Beige Vinyl	#11731	\$728.95
675	Black & Yellow Cloud Patterned Cloth w/Yellow Vinyl	#11732	\$728.95
676	Black and Red Cloud Patterned Cloth with Red Vinyl	#11733	\$728.95

Stainless Interior Door Panel Trim Kit

	DANCHUK PART#	PRICE
All	#1396	\$404.95

Glide front seat frames will incur an extra \$125 custom set-up fee.

Armrests

Upholstered and plastic base armrests are available on page 128.

Headliner - Original Material

Pre-sewn Pyramid vinyl with visor material included.

TRIM#	COLOR DESCRIPTION	DANCHUK PART#	PRICE
670	Silver Pyramid Vinyl	#11734	\$159.95
671	Green Pyramid Vinyl	#11735	\$159.95
672	Blue Pyramid Vinyl.....	#11736	\$159.95
673	Turquoise Pyramid Vinyl	#11737	\$159.95
674	Beige Pyramid Vinyl.....	#11738	\$159.95
675	Yellow Pyramid Vinyl.....	#11739	\$159.95
676	Red Pyramid Vinyl	#11740	\$159.95

Tack Strip Set

TRIM#	COLOR DESCRIPTION	DANCHUK PART#	PRICE
All	2-Dr. Hardtop Tack Strips	#11309	\$59.95

Sunvisors (Pair) - Original Material

Sewn in pyramid vinyl on new boards with new rods and chrome clips.

TRIM#	COLOR DESCRIPTION	DANCHUK PART#	PRICE
670	Silver Pyramid Vinyl	#11741	\$147.95
671	Green Pyramid Vinyl	#11742	\$147.95
672	Blue Pyramid Vinyl.....	#11743	\$147.95
673	Turquoise Pyramid Vinyl	#11744	\$147.95
674	Beige Pyramid Vinyl.....	#11745	\$147.95
675	Yellow Pyramid Vinyl.....	#11746	\$147.95
676	Red Pyramid Vinyl	#11747	\$147.95



1957 BEL AIR 4-DOOR HARDTOP

Seat Covers - Front & Rear

Pre-sewn in heavyweight vinyl and "cloud pattern" cloth with seat buttons, listings attached, ready to install. Set includes covers for front and rear seats and enough material to cover the seat caps.

TRIM#	COLOR DESCRIPTION	DANCHUK PART#	PRICE
670	Black & Silver Cloud Patterned Cloth w/Silver Vinyl	#11748	\$718.95
671	Black & Green Cloud Patterned Cloth w/Green Vinyl	#11749	\$718.95
672	Black & Blue Cloud Patterned Cloth w/Blue Vinyl	#11750	\$718.95
673	Black & Turq. Cloud Patterned Cloth w/Turq. Vinyl	#11751	\$718.95
674	Black & Copper Cloud Pattern Cloth w/Beige Vinyl	#11752	\$718.95
675	Black & Yellow Cloud Pattern Cloth w/Yellow Vinyl	#11753	\$718.95
676	Black and Red Cloud Pattern Cloth with Red Vinyl	#11754	\$718.95

Pre-Assembled Door Panels

Pre-assembled front and rear door panels, in original style materials, on new boards with metal door edge bands attached. Includes windlace, kick panels, material to cover the armrests. Stainless trim is available for an additional charge.

TRIM#	COLOR DESCRIPTION	DANCHUK PART#	PRICE
670	Black & Silver Cloud Patterned Cloth w/Silver Vinyl	#11755	\$778.95
671	Black & Green Cloud Patterned Cloth w/Green Vinyl	#11756	\$778.95
672	Black & Blue Cloud Patterned Cloth w/Blue Vinyl	#11757	\$778.95
673	Black & Turq. Cloud Patterned Cloth w/Turq. Vinyl	#11758	\$778.95
674	Black & Copper Cloud Patterned Cloth w/Beige Vinyl	#11759	\$778.95
675	Black & Yellow Cloud Patterned Cloth w/Yellow Vinyl	#11760	\$778.95
676	Black & Red Cloud Patterned Cloth w/Red Vinyl	#11761	\$778.95

Stainless Interior Door Panel Trim Kit

	DANCHUK PART#	PRICE
All	#1440	\$404.95

Armrests

Upholstered and plastic base armrests are available on page 128.

Glide front seat frames will incur an extra \$125 custom set-up fee.

Headliner - Original Material

Pre-sewn Pyramid vinyl with visor material included.

TRIM#	COLOR DESCRIPTION	DANCHUK PART#	PRICE
670	Silver Pyramid Vinyl	#11762	\$159.95
671	Green Pyramid Vinyl	#11763	\$159.95
672	Blue Pyramid Vinyl	#11764	\$159.95
673	Turquoise Pyramid Vinyl	#11765	\$159.95
674	Beige Pyramid Vinyl	#11766	\$159.95
675	Yellow Pyramid Vinyl	#11767	\$159.95
676	Red Pyramid Vinyl	#11768	\$159.95

Sunvisors (Pair) - Original Material

Sewn in pyramid vinyl on new boards with new rods and chrome clips.

TRIM#	COLOR DESCRIPTION	DANCHUK PART#	PRICE
670	Silver Pyramid Vinyl	#11741	\$147.95
671	Green Pyramid Vinyl	#11742	\$147.95
672	Blue Pyramid Vinyl	#11743	\$147.95
673	Turquoise Pyramid Vinyl	#11744	\$147.95
674	Beige Pyramid Vinyl	#11745	\$147.95
675	Yellow Pyramid Vinyl	#11746	\$147.95
676	Red Pyramid Vinyl	#11747	\$147.95



1957 BEL AIR 2-DOOR SEDAN

Seat Covers - Front & Rear

Pre-sewn in heavyweight vinyl and "cloud pattern" cloth, listings attached, ready to install. Set includes covers for front and rear seats and enough material to cover the seat caps.

TRIM#	COLOR DESCRIPTION	DANCHUK PART#	PRICE
663	Black & Silver Cloud Patterned Cloth w/ Silver Vinyl	#11769	\$718.95
664	Black & Green Cloud Patterned Cloth w/Green Vinyl	#11770	\$718.95
665	Black & Blue Cloud Patterned Cloth w/Blue Vinyl	#11771	\$718.95
666	Black & Turq. Cloud Patterned Cloth w/ Turq. Vinyl	#11772	\$718.95
667	Black & Copper Cloud Patterned Cloth w/Beige Vinyl	#11773	\$718.95
668	Black & Yellow Cloud Patterned Cloth w/ Yellow Vinyl	#11774	\$718.95
669	Black & Red Cloud Patterned Cloth w/Red Vinyl	#11775	\$718.95

Pre-Assembled Door Panels - 2-Door

Pre-assembled front and rear panels, in original style materials, on new boards with metal door edge bands attached. Includes windlace, kick panels and enough material to cover the armrests. Stainless trim is available for an additional charge.

TRIM#	COLOR DESCRIPTION	DANCHUK PART#	PRICE
663	Black & Silver Cloud Patterned Cloth w/ Silver Vinyl	#11776	\$728.95
664	Black & Green Cloud Patterned Cloth w/ Green Vinyl	#11777	\$728.95
665	Black & Blue Cloud Patterned Cloth w/Blue Vinyl	#11778	\$728.95
666	Black & Turq. Cloud Patterned Cloth w/ Turq. Vinyl	#11779	\$728.95
667	Black & Copper Cloud Patterned Cloth w/Beige Vinyl	#11780	\$728.95
668	Black & Yellow Cloud Patterned Cloth w/ Yellow Vinyl	#11781	\$728.95
669	Black & Red Cloud Patterned Cloth w/ Red Vinyl	#11782	\$728.95

Stainless Interior Door Panel Trim Kit

	DANCHUK PART#	PRICE
All	#1439	\$244.95

Armrests

Upholstered and plastic base armrests are available on page 128.

Headliner - Original Material

Pre-sewn in "Dobey" cloth with visor material included.

TRIM#	COLOR DESCRIPTION	DANCHUK PART#	PRICE
663	Gray Cloth	#11783	\$189.95
664	Green Cloth	#11784	\$189.95
665	Blue Cloth	#11785	\$189.95
666	Turquoise cloth	#11786	\$189.95
667	Beige Cloth	#11787	\$189.95
668	Yellow cloth	#11788	\$189.95
669	Gray Cloth	#11783	\$189.95

Tack Strip Set

TRIM#	COLOR DESCRIPTION	DANCHUK PART#	PRICE
All	56 2-Dr. Sedan Tack Strips	#11312	\$40.95

Sunvisors (Pair) - Original Material

Sewn in "Dobey" cloth on new boards with new rods and chrome clips.

TRIM#	COLOR DESCRIPTION	DANCHUK PART#	PRICE
663	Gray Cloth	#11789	\$147.95
664	Green Cloth	#11790	\$147.95
665	Blue Cloth	#11791	\$147.95
666	Turquoise Cloth	#11792	\$147.95
667	Beige Cloth	#11793	\$147.95
668	Yellow Cloth	#11794	\$147.95
669	Gray Cloth	#11789	\$147.95

Glide front seat frames will incur an extra \$125 custom set-up fee.



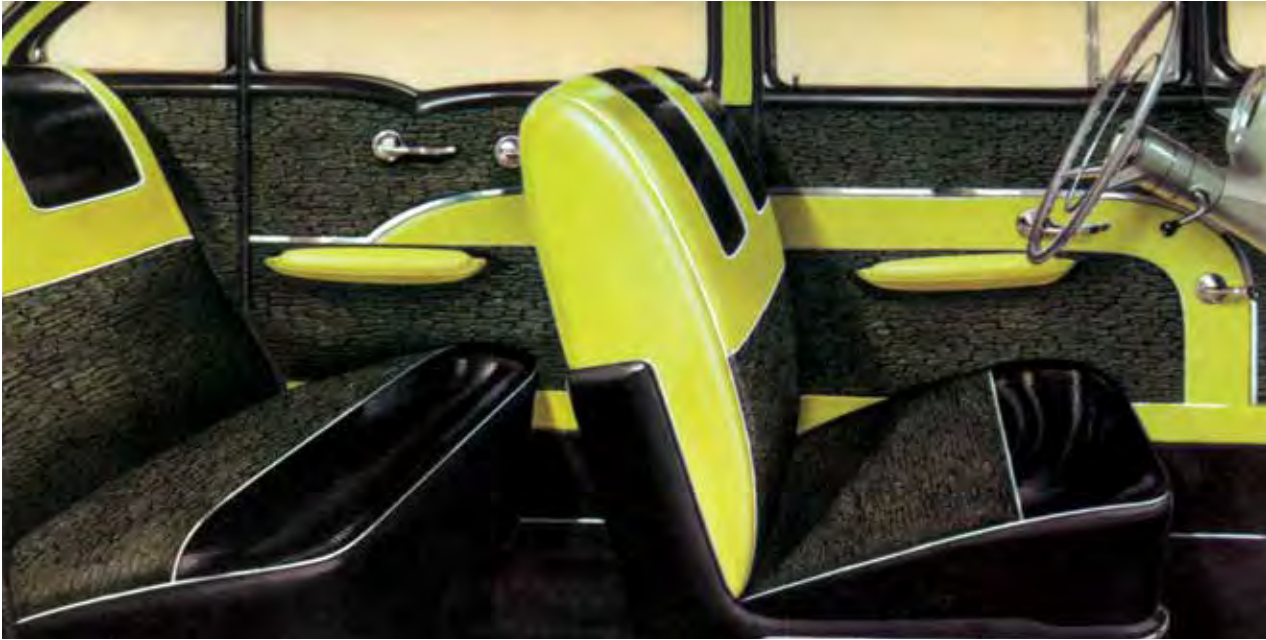

1957 BEL AIR 4-DOOR SEDAN

Seat Covers - Front & Rear

Pre-sewn in heavyweight vinyl and "cloud pattern" cloth, listings attached, ready to install. Set includes covers for front and rear seats and enough material to cover the seat caps.

TRIM#	COLOR DESCRIPTION	DANCHUK PART#	PRICE
663	Black & Silver Cloud Patterned Cloth w/Silver Vinyl	#11795	\$718.95
664	Black & Green Cloud Patterned Cloth w/ Green Vinyl	#11796	\$718.95
665	Black & Blue Cloud Patterned Cloth w/Blue Vinyl	#11797	\$718.95
666	Black & Turq. Cloud Patterned Cloth with Turq. Vinyl	#11798	\$718.95
667	Black & Copper Cloud Patterned Cloth w/Beige Vinyl	#11799	\$718.95
668	Black & Yellow Cloud Patterned Cloth w/ Yellow Vinyl	#11800	\$718.95
669	Black & Red Cloud Patterned Cloth with Red Vinyl	#11801	\$718.95

Pre-Assembled Door Panels

Pre-assembled front and rear door panels with new rear upper panels, in original style materials, on new boards with metal door edge bands attached. Includes windlace, kick panels and enough material to cover the armrests. Stainless trim is available for an additional charge.

TRIM#	COLOR DESCRIPTION	DANCHUK PART#	PRICE
663	Black & Silver Cloud Patterned Cloth w/Silver Vinyl	#11802	\$778.95
664	Black & Green Cloud Patterned Cloth w/ Green Vinyl	#11803	\$778.95
665	Black & Blue Cloud Patterned Cloth w/ Blue Vinyl	#11804	\$778.95
666	Black & Turq. Cloud Patterned Cloth w/ Turq. Vinyl	#11805	\$778.95
667	Black & Copper Cloud Patterned Cloth w/Beige Vinyl	#11806	\$778.95
668	Black & Yellow Cloud Patterned Cloth w/ Yellow Vinyl	#11807	\$778.95
669	Black & Red Cloud Patterned Cloth w/ Red Vinyl	#11808	\$778.95

Glide front seat frames will incur an extra \$125 custom set-up fee.

Stainless Interior Door Panel Trim Kit

	DANCHUK PART#	PRICE
All	#11326	\$244.95

Armrests

Upholstered and plastic base armrests are available on page 128.

Tack Strips

TRIM#	COLOR DESCRIPTION	DANCHUK PART#	PRICE
All	4-Dr. Sedan Tack Strips	#11314	\$51.95

Headliner - Original Material

Pre-sewn in "Dobey" cloth with visor and post material included.

TRIM#	COLOR DESCRIPTION	DANCHUK PART#	PRICE
663	Gray Cloth	#11783	\$189.95
664	Green Cloth	#11784	\$189.95
665	Blue Cloth	#11785	\$189.95
666	Turquoise cloth	#11786	\$189.95
667	Beige Cloth	#11787	\$189.95
668	Yellow Cloth	#11788	\$189.95
669	Gray Cloth	#11783	\$189.95

Sunvisors (Pair) - Original Material

Sewn in "Dobey" cloth on new boards with new rods and chrome clips.

TRIM#	COLOR DESCRIPTION	DANCHUK PART#	PRICE
663	Gray Cloth	#11789	\$147.95
664	Green Cloth	#11790	\$147.95
665	Blue Cloth	#11791	\$147.95
666	Turquoise Cloth	#11792	\$147.95
667	Beige Cloth	#11793	\$147.95
668	Yellow Cloth	#11794	\$147.95
669	Gray Cloth	#11789	\$147.95



1957 BEL AIR 4-DOOR WAGON

Seat Covers - Front & Rear

Pre-sewn in heavyweight vinyl and "cloud pattern" cloth, listings attached, ready to install. Set includes covers for front and rear seats and enough material to cover the seat caps.

TRIM#	COLOR DESCRIPTION	DANCHUK PART#	PRICE
684	Black & Silver Cloud Patterned Cloth w/ Silver Vinyl	#11809	\$718.95
685	Black & Green Cloud Patterned Cloth w/ Green Vinyl	#11810	\$718.95
686	Black & Blue Cloud Patterned Cloth w/ Blue Vinyl	#11811	\$718.95
687	Black & Turq. Cloud Patterned Cloth w/ Turq. Vinyl	#11812	\$718.95
688	Black & Copper Cloud Patterned Cloth w/ Beige Vinyl	#11813	\$718.95
689	Black & Yellow Cloud Patterned Cloth w/ Yellow Vinyl	#11814	\$718.95
690	Black & Red Cloud Patterned Cloth w/ Red Vinyl	#11815	\$718.95

Pre-Assembled Door Panels

Pre-assembled front and rear panels on new boards with metal door edge bands attached. Includes windlace, kick panels, wheelwell covers, over the wheel well boards and material to cover the armrests.

TRIM#	COLOR DESCRIPTION	DANCHUK PART#	PRICE
684	Black & Silver Cloud Patterned Cloth w/Silver Vinyl	#11816	\$838.95
685	Black & Green Cloud Patterned Cloth w/ Green Vinyl	#11817	\$838.95
686	Black & Blue Cloud Patterned Cloth w/ Blue Vinyl	#11818	\$838.95
687	Black & Turq. Cloud Patterned Cloth w/ Turq. Vinyl	#11819	\$838.95
688	Black & Copper Cloud Patterned Cloth w/ Beige Vinyl	#11820	\$838.95
689	Black & Yellow Cloud Patterned Cloth w/Yellow Vinyl	#11821	\$838.95
690	Black & Red Cloud Patterned Cloth w/Red Vinyl	#11822	\$838.95

Glide front seat frames will incur an extra \$125 custom set-up fee.

Armrests

Upholstered and plastic base armrests are available on page 128.

Headliner - Original Material

Pre-sewn Pyramid vinyl with visor material included.

TRIM#	COLOR DESCRIPTION	DANCHUK PART#	PRICE
684	Silver Pyramid Vinyl	#11823	\$198.95
685	Green Pyramid Vinyl	#11824	\$198.95
686	Blue Pyramid Vinyl	#11825	\$198.95
687	Turq. Pyramid Vinyl	#11826	\$198.95
688	Beige Pyramid Vinyl	#11827	\$198.95
689	Yellow Pyramid Vinyl	#11828	\$198.95
690	Red "Pyramid" Vinyl	#11829	\$198.95

Tack Strip Set

TRIM#	COLOR DESCRIPTION	DANCHUK PART#	PRICE
All	4-Dr. Wagon Tack Strip Set	#11316	\$53.95

Sunvisors (Pair)

Pre-sewn pyramid vinyl on new boards with new rods and chrome clips.

TRIM#	COLOR DESCRIPTION	DANCHUK PART#	PRICE
684	Silver Pyramid Vinyl	#11741	\$147.95
685	Green Pyramid Vinyl	#11742	\$147.95
686	Blue Pyramid Vinyl	#11743	\$147.95
687	Turq. Pyramid Vinyl	#11744	\$147.95
688	Beige Pyramid Vinyl	#11745	\$147.95
689	Yellow Pyramid Vinyl	#11746	\$147.95
690	Red "Pyramid" Vinyl	#11747	\$147.95



1957 CONVERTIBLE

Seat Covers - Front & Rear

Pre-sewn in correct circle and pressed stitch pattern vinyl with seat buttons, listings attached, ready to install. Set includes covers for front and rear seats and enough material to cover the seat caps.

TRIM#	COLOR DESCRIPTION	DANCHUK PART#	PRICE
677	Silver and Ivory Vinyl.....	#11830	\$768.95
681	Copper and Beige Vinyl.....	#11831	\$768.95
682	Silver and Yellow Vinyl.....	#11832	\$768.95
683	Silver and Red Vinyl.....	#11833	\$768.95
678	Med. Green and Light Green Vinyl.....	#11834	\$768.95
679	Med. Blue and Light Blue Vinyl.....	#11835	\$768.95
680	Turquoise and Ivory Vinyl.....	#11836	\$749.95

Pre-Assembled Door Panels - 2-Door

Pre-assembled front and rear upper panels, in original style materials, on new boards with metal door edge bands attached. Includes windlace, kick panels, material to cover the front armrests and sewn rear armrest and piston covers. Stainless trim is available for an additional charge.

TRIM#	COLOR DESCRIPTION	DANCHUK PART#	PRICE
677	Silver and Ivory Vinyl.....	#11837	\$728.95
681	Copper and Beige Vinyl.....	#11838	\$728.95
682	Silver and Yellow Vinyl.....	#11839	\$728.95
683	Silver and Red Vinyl.....	#11840	\$728.95
678	Med. Green and Light Green Vinyl.....	#11841	\$728.95
679	Med. Blue and Light Blue Vinyl.....	#11842	\$728.95
680	Turquoise and Ivory Vinyl.....	#11843	\$728.95

Stainless Interior Door Panel Trim Kit

	DANCHUK PART#	PRICE
All	#1397	\$404.95

Glide front seat frames will incur an extra \$125 custom set-up fee.

Convertible Top

Made from 36 oz. GM pinpoint vinyl with plastic back window, sewn as original. Top and junior side pads are included.

TRIM#	COLOR DESCRIPTION	DANCHUK PART#	PRICE
All	White.....	#11452	\$498.95
All	Black.....	#11451	\$498.95
All	Beige.....	#11453	\$498.95

Convertible Top Header Strips

TRIM#	COLOR DESCRIPTION	DANCHUK PART#	PRICE
All	Convertible Top Header Strips.....	#1523	\$76.95

Convertible Top Tack Strips

TRIM#	COLOR DESCRIPTION	DANCHUK PART#	PRICE
All	Convertible Top Tack Strips.....	#1521	\$34.95

Sunvisors (Pair) - Original Material

Sewn in vinyl on new boards with new rods and chrome clips.

TRIM#	COLOR DESCRIPTION	DANCHUK PART#	PRICE
677	Silver Vinyl.....	#11844	\$147.95
681	Copper Vinyl.....	#11647	\$147.95
682	Silver Vinyl.....	#11844	\$147.95
683	Silver Vinyl.....	#11844	\$147.95
678	Green Vinyl.....	#11845	\$147.95
679	Blue Vinyl.....	#11846	\$147.95
680	Turquoise Vinyl.....	#11847	\$147.95

Top Well Liner

Correctly sewn and ready to install.

TRIM#	COLOR DESCRIPTION	DANCHUK PART#	PRICE
All	Black.....	#11462	\$79.95
	Option Beige.....	#11628	\$89.95

Convertible Top Boot Covers

Pre-sewn in vinyl, complete with Naugastay stiffener and snaps (not installed).

TRIM#	COLOR DESCRIPTION	DANCHUK PART#	PRICE
677	Ivory Vinyl.....	#11848	\$255.95
681	Beige Vinyl.....	#11849	\$255.95
682	Yellow Vinyl.....	#11850	\$255.95
683	Red Vinyl.....	#11851	\$255.95
678	Green Vinyl.....	#11852	\$255.95
679	Blue Vinyl.....	#11853	\$255.95
680	Ivory Vinyl.....	#11848	\$255.95
	Option Black Vinyl.....	#11468	\$255.95



1957 NOMAD

Seat Covers - Front & Rear

Pre-sewn in heavyweight vinyl and "cloud pattern" cloth with seat buttons, listings attached, ready to install. Set includes covers for front and rear seats and enough material to cover the seat caps.

TRIM#	COLOR DESCRIPTION	DANCHUK PART#	PRICE
691	Black & Silver Cloud Patterned Cloth w/Silver Vinyl	#11854	\$718.95
692	Black & Green Cloud Patterned Cloth w/Green Vinyl	#11855	\$718.95
693	Black & Blue Cloud Patterned Cloth w/ Blue Vinyl	#11856	\$718.95
694	Black & Turq. Cloud Patterned Cloth with Turq. Vinyl	#11857	\$718.95
695	Black & Copper Cloud Patterned Cloth w/Beige Vinyl	#11858	\$718.95
696	Black & Yellow Cloud Patterned Cloth w/ Yellow Vinyl	#11859	\$718.95
697	Black & Red Cloud Patterned Cloth w/ Red Vinyl	#11860	\$718.95

Pre-Assembled Door Panels

Pre-assembled front and rear panels on new boards with metal door edge bands attached. Includes windlace, kick panels, wheelwell covers, over the wheel well boards and material to cover the armrests. Stainless trim is available for an additional charge.

TRIM#	COLOR DESCRIPTION	DANCHUK PART#	PRICE
691	Black & Silver Cloud Patterned Cloth w/ Silver Vinyl	#11861	\$778.95
692	Black & Green Cloud Patterned Cloth w/ Green Vinyl	#11862	\$778.95
693	Black & Blue Cloud Patterned Cloth w/ Blue Vinyl	#11863	\$778.95
694	Black & Turq. Cloud Patterned Cloth with Turq. Vinyl	#11864	\$778.95
695	Black & Copper Cloud Patterned Cloth w/Beige Vinyl	#11865	\$778.95
696	Black & Yellow Cloud Patterned Cloth w/ Yellow Vinyl	#11866	\$778.95
697	Black & Red Cloud Patterned Cloth w/ Red Vinyl	#11867	\$778.95

Glide front seat frames will incur an extra \$125 custom set-up fee.

Stainless Interior Door Panel Trim Kit

	DANCHUK PART#	PRICE
All	#2041	\$404.95

Headliner - Original Material

Pre-sewn Pyramid vinyl with visor material included.

TRIM#	COLOR DESCRIPTION	DANCHUK PART#	PRICE
691	Silver Pyramid Vinyl	#11868	\$198.95
692	Green Pyramid Vinyl	#11869	\$198.95
693	Blue Pyramid Vinyl	#11870	\$198.95
694	Turq. Pyramid Vinyl	#11871	\$198.95
695	Beige Pyramid Vinyl	#11872	\$198.95
696	Yellow Pyramid Vinyl	#11873	\$198.95
697	Red Pyramid Vinyl	#11874	\$198.95

Tack Strip Set

TRIM#	COLOR DESCRIPTION	DANCHUK PART#	PRICE
All	Nomad Headliner Tack Strips	#11310	\$77.95

Sunvisors (Pair) - Original Material

Sewn in pyramid vinyl on new boards with new rods and chrome clips.

TRIM#	COLOR DESCRIPTION	DANCHUK PART#	PRICE
691	Silver Pyramid Vinyl	#11741	\$147.95
692	Green Pyramid Vinyl	#11742	\$147.95
693	Blue Pyramid Vinyl	#11743	\$147.95
694	Turq. Pyramid Vinyl	#11875	\$147.95
695	Beige Pyramid Vinyl	#11745	\$147.95
696	Yellow Pyramid Vinyl	#11746	\$147.95
697	Red Pyramid Vinyl	#11747	\$147.95

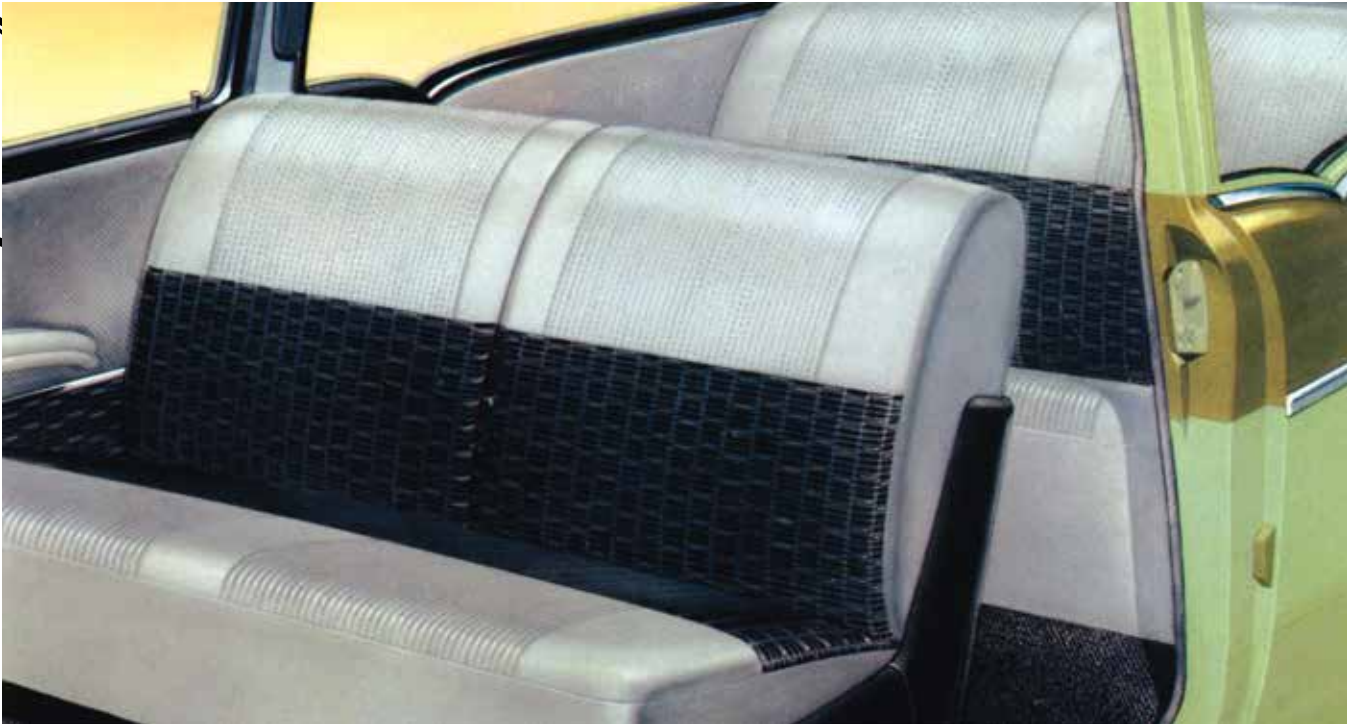

1957 210 2-DOOR SEDAN

Seat Covers - Front & Rear

Pre-sewn in original patterned cloth with gold mylar bars, press stitched and plain vinyls, in original colors with all listings attached, ready to install. Set includes covers for front and rear seats and enough material to cover the seat caps.

TRIM#	COLOR DESCRIPTION	DANCHUK PART#	PRICE
654	Charcoal Cloth and Ivory Vinyl	#11876.....	\$718.95
655	Green Cloth and Green Vinyl	#11877.....	\$718.95
656	Blue Cloth and Blue Vinyl	#11878.....	\$718.95

Pre-Assembled Door Panels - 2-Door

Pre-assembled door and rear quarter panels. These include new boards, metal door edge bands and original style materials attached. Also includes sewn windlace and kick panels. Stainless trim not included.

TRIM#	COLOR DESCRIPTION	DANCHUK PART#	PRICE
654	Charcoal Cloth and Ivory Vinyl	#11879.....	\$778.95
655	Green Cloth and Green Vinyl	#11880.....	\$778.95
656	Blue Cloth and Blue Vinyl	#11881.....	\$778.95

Stainless Interior Door Panel Trim Kit

	DANCHUK PART#	PRICE
All	#2044	\$324.95

Headliner - Original Material

Pre-sewn napped cloth with visor material included.

TRIM#	COLOR DESCRIPTION	DANCHUK PART#	PRICE
654	Gray Cloth.....	#12046.....	\$179.95
655	Green Cloth	#12047.....	\$159.95
656	Lt Blue Cloth.....	#12048.....	\$159.95

Tack Strip Sets

TRIM#	COLOR DESCRIPTION	DANCHUK PART#	PRICE
All	2-Dr. Sedan Tack Strip Set	#11312.....	\$40.95

Sunvisors (Pair) - Original Material

TRIM#	COLOR DESCRIPTION	DANCHUK PART#	PRICE
All	Option Black Cloth	#12214.....	\$147.95
654	Gray Cloth	#12215.....	\$147.95
655	Green Cloth	#12216.....	\$147.95
656	Light Blue Cloth	#12217.....	\$147.95



Glide front seat frames will incur an extra \$125 custom set-up fee.



1957 DEL RAY 2-DOOR SEDAN

Seat Covers - Front & Rear

Pre-sewn in reproduction "Inca" patterned vinyl and plain vinyl, in original colors with all listings attached, ready to install. Set includes covers for front and rear seats and enough material to cover the seat caps.

TRIM#	COLOR DESCRIPTION	DANCHUK PART#	PRICE
660	Charcoal Vinyl and Ivory Vinyl.....	#11888	\$798.95
661	Green Vinyl and Green Vinyl	#11889	\$798.95
662	Beige Vinyl and Copper Vinyl	#11889A	\$798.95

Pre-Assembled Door Panels - 2-Door

Pre-assembled door and rear quarter panels. These include new boards, metal door edge bands and original style materials attached. Also includes sewn windlace and kick panels. Stainless trim not included.

TRIM#	COLOR DESCRIPTION	DANCHUK PART#	PRICE
660	Charcoal Vinyl and Ivory Vinyl.....	#11890	\$778.95
661	Green Vinyl and Green Vinyl	#11891	\$778.95
662	Beige Vinyl and Copper Vinyl	#11891A	\$778.95

Stainless Interior Door Panel Trim Kit

	DANCHUK PART#	PRICE
All	#11325	\$208.95

Headliner - Original Material

Pre-sewn Pyramid vinyl with visor material included. (Chain-link material is not available.)

TRIM#	COLOR DESCRIPTION	DANCHUK PART#	PRICE
660	Ivory Pyramid Vinyl	#11892	\$159.95
661	Green Pyramid Vinyl	#11893	\$159.95
662	Beige Pyramid Vinyl	#11894	\$159.95

Tack Strip Set

TRIM#	COLOR DESCRIPTION	DANCHUK PART#	PRICE
All	2-Door Sedan Tack Strip Set.....	#11312	\$40.95

Sunvisors (Pair) - Original Material

Sewn in pyramid vinyl on new boards with new rods and chrome clips.

TRIM#	COLOR DESCRIPTION	DANCHUK PART#	PRICE
660	Ivory Vinyl, Pyramid	#12049	\$147.95
661	Green Vinyl, Pyramid	#12050	\$147.95
662	Beige Vinyl, Pyramid.....	#12051	\$147.95

1957 210 4-DOOR SEDAN

Seat Covers - Front & Rear

Pre-sewn in original patterned cloth with gold mylar bars, press stitched and plain vinyls, in original colors with all listings attached, ready to install. Set includes covers for front and rear seats and enough material to cover the seat caps. Stainless trim available for additional charge.

TRIM#	COLOR DESCRIPTION	DANCHUK PART#	PRICE
654	Charcoal Cloth and Ivory Vinyl	#11882	\$718.95
655	Green Cloth and Light Green Vinyl.....	#11883	\$718.95
656	Blue Cloth and Light Blue Vinyl	#11884	\$718.95

Pre-Assembled Door Panels - 4-Door

Pre-assembled door and rear quarter panels. These include new boards, metal door edge bands and original style materials attached. Also includes sewn windlace and kick panels. Stainless trim not included.

TRIM#	COLOR DESCRIPTION	DANCHUK PART#	PRICE
654	Charcoal Cloth and Ivory Vinyl	#11885	\$818.95
655	Green Cloth and Light Green Vinyl	#11886	\$818.95
656	Blue Cloth and Light Blue Vinyl	#11887	\$818.95

Stainless Interior Door Panel Trim Kit

	DANCHUK PART#	PRICE
All	#2045	\$324.95

Headliner - Original Material

Pre-sewn napped cloth with visor material included.

TRIM#	COLOR DESCRIPTION	DANCHUK PART#	PRICE
654	Gray Cloth.....	#12046	\$179.95
655	Green Cloth	#12047	\$159.95
656	Lt Blue Cloth.....	#12048	\$159.95

Tack Strip Sets

TRIM#	COLOR DESCRIPTION	DANCHUK PART#	PRICE
All	4 -Dr. Sedan Tack Strip Set	#11314	\$51.95

Sunvisors (Pair) - Original Material

Sewn in napped cloth on new boards with new rods and chrome clips.

TRIM#	COLOR DESCRIPTION	DANCHUK PART#	PRICE
654	Gray Cloth	#12215	\$147.95
655	Green Cloth	#12216	\$147.95
656	Light Blue Cloth.....	#12217	\$147.95
All	Option Black Cloth	#12214	\$147.95

Glide front seat frames will incur an extra \$125 custom set-up fee.

WARNING! Products on these pages may contain chemicals known to the State Of California to cause cancer and/or birth defects or reproductive harm. www.p65warnings.ca.gov



1957 210 2-DOOR HARDTOP

Seat Covers - Front & Rear

Pre-sewn in original patterned cloth with gold mylar bars, press stitched and plain vinyls, in original colors with all listings attached, ready to install. Set includes covers for front and rear seats and enough material to cover the seat caps.

TRIM#	COLOR DESCRIPTION	DANCHUK PART#	PRICE
654	Charcoal Cloth and Ivory Vinyl	#11895	\$718.95
655	Green Cloth and Light Green Vinyl	#11896	\$718.95
656	Blue Cloth and Light Blue Vinyl	#11897	\$718.95

Pre-Assembled Door Panels

Pre-assembled front and rear upper panels, in original style materials, on new boards with metal door edge bands attached. Includes windlace, kick panels, material to cover the front armrests and sewn rear arm rest covers.

TRIM#	COLOR DESCRIPTION	DANCHUK PART#	PRICE
654	Charcoal Cloth and Ivory Vinyl	#11898	\$778.95
655	Green Cloth and Light Green Vinyl	#11899	\$778.95
656	Blue Cloth and Light Blue Vinyl	#11900	\$778.95

Tack Strip Set

TRIM#	COLOR DESCRIPTION	DANCHUK PART#	PRICE
All	2-Door Hardtop Tack Strips.....	#11309.....	\$59.95

Headliner - Original Material

Pre-sewn napped cloth with visor material included.

TRIM#	COLOR DESCRIPTION	DANCHUK PART#	PRICE
654	Gray	#11901	\$179.95
655	Green	#11902.....	\$159.95
656	Blue	#11903.....	\$159.95

Sunvisors (Pair) - Original Material

Sewn in napped cloth on new boards with new rods and chrome clips.

TRIM#	COLOR DESCRIPTION	DANCHUK PART#	PRICE
654	Gray Cloth	#12215.....	\$147.95
655	Green Cloth	#12216.....	\$147.95
656	Light Blue Cloth	#12217.....	\$147.95
All	Option Black Cloth	#12214.....	\$147.95

1957 210 4-DOOR HARDTOP

Seat Covers - Front & Rear

Pre-sewn in original patterned cloth with gold mylar bars, press stitched and plain vinyls, in original colors with all listings attached, ready to install. Set includes covers for front and rear seats and enough material to cover the seat caps.

TRIM#	COLOR DESCRIPTION	DANCHUK PART#	PRICE
654	Charcoal Cloth and Ivory Vinyl	#11904.....	\$718.95
655	Green Cloth and Light Green Vinyl	#11905.....	\$718.95
656	Blue Cloth and Blue Vinyl	#11906.....	\$718.95

Pre-Assembled Door Panels - 4-Door

Pre-assembled front and rear door panels, in original style materials, on new boards with metal door edge bands attached. Includes windlace, kick panels, material to cover the armrests.

TRIM#	COLOR DESCRIPTION	DANCHUK PART#	PRICE
654	Charcoal Cloth and Ivory Vinyl	#11907.....	\$818.95
655	Green Cloth and Ivory Vinyl	#11908.....	\$818.95
656	Blue Cloth and Blue Vinyl	#11909.....	\$818.95

Headliner - Original Material

Pre-sewn napped cloth with visor material included.

TRIM#	COLOR DESCRIPTION	DANCHUK PART#	PRICE
654	Gray	#11910.....	\$179.95
655	Green	#11911.....	\$159.95
656	Blue	#11912.....	\$159.95

Sunvisors (Pair) - Original Material

Sewn in napped cloth on new boards with new rods and chrome clips.

TRIM#	COLOR DESCRIPTION	DANCHUK PART#	PRICE
654	Gray Cloth	#12215.....	\$147.95
655	Green Cloth	#12216.....	\$147.95
656	Light Blue Cloth	#12217.....	\$147.95
All	Option Black Cloth	#12214.....	\$147.95

Glide front seat frames will incur an extra \$125 custom set-up fee.



1957 210 2-DOOR WAGON

Seat Covers - Front & Rear

Pre-sewn in original "Inca" patterned vinyl with plain vinyls, in original colors with all listings attached, ready to install. Set includes covers for front and rear seats and enough material to cover the seat caps.

TRIM#	COLOR DESCRIPTION	DANCHUK PART#	PRICE
654	Charcoal Vinyl and Ivory Vinyl	#11913	\$798.95
655	Green Vinyl and Light Green Vinyl	#11914	\$798.95
659	Copper Vinyl and Beige Vinyl	#16656	\$799.95

Pre-Assembled Door Panels - 2-Door

Pre-assembled front and rear panels on new boards with metal door edge bands attached. Includes windlace, kick panels, wheelwell covers, over the wheel well boards and material to cover the armrests.

TRIM#	COLOR DESCRIPTION	DANCHUK PART#	PRICE
654	Charcoal Vinyl and Ivory Vinyl	#11915	\$778.95
655	Green Vinyl and Light Green Vinyl	#11916	\$778.95
659	Copper Vinyl and Beige Vinyl	#16653	\$778.95

Headliner

Pre-sewn in pyramid vinyl with sunvisor material included. (Chain link material is not available.)

TRIM#	COLOR DESCRIPTION	DANCHUK PART#	PRICE
654	Ivory Pyramid Vinyl	#11917	\$198.95
655	Green Pyramid Vinyl	#11918	\$198.95
659	Beige Pyramid Vinyl	#11919	\$198.95

Sunvisors (Pair)

Sewn in pyramid vinyl on new boards with new rods and chrome clips. (Chain link material is not available.)

TRIM#	COLOR DESCRIPTION	DANCHUK PART#	PRICE
654	Ivory Pyramid Vinyl	#12049	\$147.95
655	Green Pyramid Vinyl	#12050	\$147.95
659	Beige Pyramid Vinyl	#12051	\$147.95

1957 210 4-DOOR WAGON

Seat Covers - Front & Rear

Pre-sewn in original "Inca" patterned vinyl with plain vinyls, in original colors with all listings attached, ready to install. Set includes covers for front and rear seats and enough material to cover the seat caps.

TRIM#	COLOR DESCRIPTION	DANCHUK PART#	PRICE
654	Charcoal Vinyl and Ivory Vinyl, 6-Passenger	#11920	\$798.95
655	Green Vinyl and Light Green Vinyl, 6-Psngr	#11921	\$798.95
659	Copper Vinyl and Beige Vinyl, 6-Passenger	#16655	\$799.95
654	Charcoal Vinyl and Ivory Vinyl, 9-Passenger	#11920	\$798.95
655	Green Vinyl and Light Green Vinyl, 9-Psngr	#11921	\$798.95
659	Copper Vinyl and Beige Vinyl, 9-Passenger	#16655	\$799.95

Pre-Assembled Door Panels - 4-Door

Pre-assembled front and rear panels on new boards with metal door edge bands attached. Includes windlace, kick panels, wheelwell covers, over the wheel well boards and material to cover the armrests.

654	Charcoal Vinyl and Ivory Vinyl	#11922	\$818.95
655	Green Vinyl and Light Green Vinyl	#11923	\$818.95
659	Copper Vinyl and Beige Vinyl	#16654	\$818.95

Headliner - Original Material

Pre-sewn pyramid vinyl with visor material included. (Chain-link material is not available.)

TRIM#	COLOR DESCRIPTION	DANCHUK PART#	PRICE
654	Ivory Pyramid Vinyl	#11917	\$198.95
655	Green Pyramid Vinyl	#11918	\$198.95
659	Beige Pyramid Vinyl	#11919	\$198.95

Sunvisors (Pair)

Sewn in pyramid vinyl on new boards with new rods and chrome clips. (Chain link material is not available.)

TRIM#	COLOR DESCRIPTION	DANCHUK PART#	PRICE
654	Ivory Pyramid Vinyl	#12049	\$147.95
655	Green Pyramid Vinyl	#12050	\$147.95
659	Beige Pyramid Vinyl	#12051	\$147.95

Glide front seat frames will incur an extra \$125 custom set-up fee.



1957 150 2-DOOR SEDAN

Seat Covers - Front & Rear

Pre-sewn in heavyweight vinyl and "Cobble-stone" cloth, in original colors with all listings attached, ready to install. Set includes covers for front and rear seats and enough material to cover the seat caps.

TRIM#	COLOR DESCRIPTION	DANCHUK PART#	PRICE
650	Black and Gray Cloth and Black Vinyl.....	#11924.....	\$658.95
715	Black and Gray Cloth and Silver Vinyl (Option).....	#11925.....	\$658.95

Pre-Assembled Door Panels

Pre-assembled front and rear panels, in original style materials, on new boards with metal door edge bands attached. Includes windlace, kick panels and enough material to cover the armrests.

TRIM#	COLOR DESCRIPTION	DANCHUK PART#	PRICE
650	Black and Gray Cloth and Black Vinyl.....	#11926.....	\$778.95
715	Black and Gray Cloth and Silver Vinyl (Option).....	#11927.....	\$778.95

Headliner - Original Material

Pre-sewn napped cloth with visor and upper post material included.

TRIM#	COLOR DESCRIPTION	DANCHUK PART#	PRICE
650	Gray Cloth.....	#11928.....	\$179.95
715	Gray Cloth.....	#11928.....	\$179.95

Tack Strips

TRIM#	COLOR DESCRIPTION	DANCHUK PART#	PRICE
All	2-Dr. Sedan Headliner Tack Strips.....	#11312.....	\$40.95

Sunvisors (Pair) - Original Material

Sewn in napped cloth on new boards with new rods and chrome clips.

TRIM#	COLOR DESCRIPTION	DANCHUK PART#	PRICE
650	Gray Cloth.....	#11929.....	\$129.95
715	Gray Cloth.....	#11929.....	\$129.95

1957 150 4-DOOR SEDAN

Seat Covers - Front & Rear

Pre-sewn in heavyweight vinyl and "Cobble-stone" cloth, in original colors with all listings attached, ready to install. Set includes covers for front and rear seats and enough material to cover the seat caps.

TRIM#	COLOR DESCRIPTION	DANCHUK PART#	PRICE
650	Black and Gray Cloth and Black Vinyl.....	#11930.....	\$658.95
715	Black and Gray Cloth and Silver Vinyl (Option).....	#11931.....	\$658.95

Pre-Assembled Door Panels

Pre-assembled front and rear door panels with new rear upper panels, in original style materials, on new boards with metal door edge bands attached. Includes windlace, kick panels and enough material to cover the armrests.

TRIM#	COLOR DESCRIPTION	DANCHUK PART#	PRICE
650	Black and Gray Cloth and Black Vinyl.....	#11932.....	\$818.95
715	Black and Gray Cloth and Silver Vinyl (Option).....	#11933.....	\$818.95

Headliner - Original Material

Pre-sewn napped cloth with visor and upper post material included.

TRIM#	COLOR DESCRIPTION	DANCHUK PART#	PRICE
650	Gray Cloth.....	#11928.....	\$179.95
715	Gray Cloth.....	#11928.....	\$179.95

Tack Strips

TRIM#	COLOR DESCRIPTION	DANCHUK PART#	PRICE
All	4-Dr. Sedan Tack Strips.....	#11314.....	\$51.95

Sunvisors (Pair) - Original Material

Sewn in napped cloth on new boards with new rods and chrome clips.

TRIM#	COLOR DESCRIPTION	DANCHUK PART#	PRICE
650	Gray Cloth.....	#11929.....	\$129.95
715	Gray Cloth.....	#11929.....	\$129.95

Glide front seat frames will incur an extra \$125 custom set-up fee.



1957 150 2-DOOR WAGON

Seat Covers - Front & Rear

Pre-sewn in heavyweight vinyl and "Cobble-stone" cloth, in original colors with all listings attached, ready to install. Set includes covers for front and rear seats and enough material to cover the seat caps.

TRIM#	COLOR DESCRIPTION	DANCHUK PART#	PRICE
650	Black and Gray Cloth and Black Vinyl	#11934	\$658.95
715	Black and Gray Cloth and Silver Vinyl (Option)	#11935	\$658.95

Pre-Assembled Door Panels

Pre-assembled front and rear panels on new boards with metal door edge bands attached. Includes windlace, kick panels, wheelwell covers, over the wheel well boards and material to cover the front and rear armrests.

TRIM#	COLOR DESCRIPTION	DANCHUK PART#	PRICE
650	Black and Gray Cloth and Black Vinyl	#11936	\$778.95
715	Black and Gray Cloth and Silver Vinyl (Option)	#11937	\$778.95

Headliner

Pre-sewn in vinyl with visor material included.

TRIM#	COLOR DESCRIPTION	DANCHUK PART#	PRICE
650	Gray Vinyl	#12052	\$182.95
715	Gray Vinyl	#12052	\$182.95

Tack Strips

TRIM#	COLOR DESCRIPTION	DANCHUK PART#	PRICE
All	2-Dr. Wagon Tack Strips	#11315	\$59.95

Sunvisors (Pair)

Sewn in vinyl on new boards with new rods and chrome clips.

TRIM#	COLOR DESCRIPTION	DANCHUK PART#	PRICE
650	Gray Vinyl	#15516	\$147.95
715	Gray Vinyl	#15516	\$147.95

1957 150 SEDAN DELIVERY

Seat Covers - Bucket Seats

Pre-sewn in heavyweight vinyl and "Cobble-stone" cloth, in original colors with all listings attached, ready to install. Set includes covers for front bucket seats and enough material to cover the seat caps.

TRIM#	COLOR DESCRIPTION	DANCHUK PART#	PRICE
650	Black and Gray Cloth and Black Vinyl	#11942	\$399.95
715	Black and Gray Cloth and Silver Vinyl (Option)	#11943	\$399.95

Pre-Assembled Door Panels (Front Only)

Pre-assembled front panels in original style materials, on new boards with metal edge bands attached. Includes windlace and enough material to cover the armrests.

TRIM#	COLOR DESCRIPTION	DANCHUK PART#	PRICE
650	Black and Gray Cloth and Black Vinyl	#17677	\$499.95
715	Black and Gray Cloth and Silver Vinyl (Option)	#17678	\$499.95

Headliner

Pre-sewn in vinyl with visor material included.

TRIM#	COLOR DESCRIPTION	DANCHUK PART#	PRICE
650	Gray Vinyl	#12052	\$182.95
715	Gray Vinyl	#12052	\$182.95

Tack Strips

TRIM#	COLOR DESCRIPTION	DANCHUK PART#	PRICE
All	Sedan Delivery Tack Strips	#11317	\$78.95

Sunvisors (Pair)

Sewn in vinyl on new boards with new rods and chrome clips.

TRIM#	COLOR DESCRIPTION	DANCHUK PART#	PRICE
650	Gray Vinyl	#15516	\$147.95
715	Gray Vinyl	#15516	\$147.95

Glide front seat frames will incur an extra \$125 custom set-up fee.



1957 150 4-DOOR WAGON

Seat Covers - Front & Rear

Pre-sewn in heavyweight vinyl and "Cobble-stone" cloth, in original colors with all listings attached, ready to install. Set includes covers for front and rear seats and enough material to cover the seat caps.

TRIM#	COLOR DESCRIPTION	DANCHUK PART#	PRICE
650	Black and Gray Cloth and Black Vinyl.....	#11938.....	\$718.95
715	Black and Gray Cloth and Silver Vinyl (Option).....	#11939.....	\$718.95

Pre-Assembled Door Panels

Pre-assembled front and rear panels on new boards with metal door edge bands attached. Includes windlace, kick panels, wheelwell covers, over the wheel well boards and material to cover the armrests.

TRIM#	COLOR DESCRIPTION	DANCHUK PART#	PRICE
650	Black and Gray Cloth and Black Vinyl.....	#11940.....	\$818.95
715	Black and Gray Cloth and Silver Vinyl (Option).....	#11941.....	\$818.95

Headliner

Pre-sewn in vinyl with visor material included.

TRIM#	COLOR DESCRIPTION	DANCHUK PART#	PRICE
650	Gray Vinyl.....	#12052.....	\$182.95
715	Gray Vinyl.....	#12052.....	\$182.95

Tack Strips

TRIM#	COLOR DESCRIPTION	DANCHUK PART#	PRICE
All	4-Dr. Wagon Tack Strips.....	#11316.....	\$53.95

Sunvisors (Pair)

Sewn in vinyl on new boards with new rods and chrome clips.

TRIM#	COLOR DESCRIPTION	DANCHUK PART#	PRICE
650	Gray Vinyl.....	#15516.....	\$147.95
715	Gray Vinyl.....	#15516.....	\$147.95

1957 150 2-DOOR UTILITY SEDAN

Seat Covers - Bench Seats, Front Only

Pre-sewn in heavyweight vinyl and "Cobble-stone" cloth, in original colors with all listings attached, ready to install. Set includes covers for front seats and enough material to cover the seat caps. No stainless on 150 doors and seats.

TRIM#	COLOR DESCRIPTION	DANCHUK PART#	PRICE
650	Black and Gray Cloth and Black Vinyl.....	#17675.....	\$449.95
715	Black and Gray Cloth and Silver Vinyl (Option).....	#17676.....	\$449.95

Pre-Assembled Door Panels - 2-Door

Pre-assembled front and rear panels, in original style materials, on new boards with metal door edge bands attached. Includes windlace, kick panels and enough material to cover the armrests. Stainless trim is available for an additional charge.

TRIM#	COLOR DESCRIPTION	DANCHUK PART#	PRICE
650	Black and Gray Cloth and Black Vinyl.....	#11944.....	\$768.95
715	Black and Gray Cloth and Silver Vinyl (Option).....	#11945.....	\$768.95

Headliner - Original Material

Pre-sewn napped cloth with visor material included.

TRIM#	COLOR DESCRIPTION	DANCHUK PART#	PRICE
650	Gray Cloth.....	#11928.....	\$179.95
715	Gray Cloth.....	#11928.....	\$179.95

Tack Strips

TRIM#	COLOR DESCRIPTION	DANCHUK PART#	PRICE
All	2-Dr. Sedan Tack Strips.....	#11312.....	\$40.95

Sunvisors (Pair) - Original Material

Sewn in napped cloth on new boards with new rods and chrome clips.

TRIM#	COLOR DESCRIPTION	DANCHUK PART#	PRICE
650	GRAY CLOTH.....	#11929.....	\$129.95
715	GRAY CLOTH.....	#11929.....	\$129.95

Glide front seat frames will incur an extra \$125 custom set-up fee.

CARPET SETS

Three carpet styles are currently available for the 1955 and 1956: the original Daytona weave, a replacement loop, and a plush. For the 1957 we have the original loop (in correct colors), and a plush. Carpet sets are pre-sewn with heel pad and jute padding attached. Other colors available, please inquire. Note: These carpets are shipped directly to you from our supplier. Please add \$35 freight charge for all carpet orders shipping to destinations within the 48 contiguous states. For Alaska, Hawaii, Puerto Rico and all other international addresses, call for a freight quote. See one piece moulded carpets if you want entire floor to be covered.

1955 2-DOOR HARDTOP

w/ Bench Seats, Red Plush	#10563	\$189.95/set
w/ Bench Seats, Blue Plush.....	#10564	\$189.95/set
w/ Bench Seats, Black Plush.....	#10565	\$189.95/set
w/ Bench Seats, Dark Blue Plush	#10566	\$189.95/set
w/ Bench Seats, Gray Plush	#10567	\$189.95/set
w/ Bench Seats, Red Loop	#10568	\$189.95/set
w/ Bench Seats, Blue Loop	#10569	\$189.95/set
w/ Bench Seats, Black Loop	#10570	\$189.95/set
w/ Bench Seats, Dark Blue Loop	#10571	\$189.95/set
w/ Bench Seats, Gray Loop	#10572	\$189.95/set
w/ Bench Seats, Daytona, Lt. Blue			
.....	#11959	\$458.95/set
w/ Bench Seats, Daytona, Turq...	#11961	\$458.95/set
w/ Bench Seats, Daytona, Red....	#11962	\$429.95/set
w/ Bench Seats, Daytona, Lt. Green			
.....	#11963	\$458.95/set
w/ Bench Seats, Daytona, Gray ...	#11960	\$458.95/set
w/ Bench Seats, Daytona, Black..	#11964	\$458.95/set
w/ Bench Seats, Daytona, Brown	#17942	\$458.95/set
w/ Bucket Seats, Red Plush	#10573	\$189.95/set
w/ Bucket Seats, Blue Plush	#10574	\$189.95/set
w/ Bucket Seats, Black Plush	#10575	\$189.95/set
w/ Bucket Seats, Dark Blue Plush	#10576	\$189.95/set
w/ Bucket Seats, Gray Plush	#10577	\$189.95/set
w/ Bucket Seats, Red Loop	#10578	\$189.95/set
w/ Bucket Seats, Blue Loop	#10579	\$189.95/set
w/ Bucket Seats, Black Loop	#10580	\$189.95/set
w/ Bucket Seats, Dark Blue Loop	#10581	\$189.95/set
w/ Bucket Seats, Gray Loop	#10582	\$189.95/set

1955 2-DOOR SEDAN

w/ Bench Seats, Red Plush	#10583	\$189.95/set
w/ Bench Seats, Blue Plush.....	#10584	\$189.95/set
w/ Bench Seats, Black Plush.....	#10585	\$189.95/set
w/ Bench Seats, Dark Blue Plush	#10586	\$189.95/set
w/ Bench Seats, Gray Plush	#10587	\$189.95/set
w/ Bench Seats, Red Loop	#10588	\$189.95/set
w/ Bench Seats, Blue Loop	#10589	\$189.95/set
w/ Bench Seats, Black Loop	#10590	\$189.95/set
w/ Bench Seats, Dark Blue Loop	#10591	\$189.95/set
w/ Bench Seats, Gray Loop	#10592	\$189.95/set
w/ Bench Seats, Daytona, Blue ...	#11949	\$458.95/set
w/ Bench Seats, Daytona, Gray ...	#11950	\$458.95/set
w/ Bench Seats, Daytona, Turquoise			
.....	#11951	\$458.95/set
w/ Bench Seats, Daytona, Brown	#11952	\$458.95/set
w/ Bench Seats, Daytona, Green	#11953	\$458.95/set
w/ Bench Seats, Daytona, Lt. Blue			
.....	#11983	\$458.95/set
w/ Bench Seats, Daytona, Lt. Green			
.....	#11984	\$458.95/set
w/ Bench Seats, Daytona, Black..	#11995	\$458.95/set
w/ Bucket Seats, Red Plush	#10593	\$189.95/set
w/ Bucket Seats, Blue Plush	#10594	\$189.95/set
w/ Bucket Seats, Black Plush	#10595	\$189.95/set
w/ Bucket Seats, Dark Blue Plush	#10596	\$189.95/set

1955 2-DOOR SEDAN CONTINUED

w/ Bucket Seats, Gray Plush	#10597	\$189.95/set
w/ Bucket Seats, Red Loop	#10598	\$189.95/set
w/ Bucket Seats, Blue Loop	#10599	\$189.95/set
w/ Bucket Seats, Black Loop	#10600	\$189.95/set
w/ Bucket Seats, Dark Blue Loop	#10601	\$189.95/set
w/ Bucket Seats, Gray Loop	#10602	\$189.95/set

1955 4-DOOR SEDAN

w/ Bench Seats, Red Plush	#10603	\$189.95/set
w/ Bench Seats, Blue Plush.....	#10604	\$189.95/set
w/ Bench Seats, Black Plush.....	#10605	\$189.95/set
w/ Bench Seats, Dark Blue Plush	#10606	\$189.95/set
w/ Bench Seats, Gray Plush	#10607	\$189.95/set
w/ Bench Seats, Red Loop	#10608	\$189.95/set
w/ Bench Seats, Blue Loop	#10609	\$189.95/set
w/ Bench Seats, Black Loop	#10610	\$189.95/set
w/ Bench Seats, Dark Blue Loop	#10611	\$189.95/set
w/ Bench Seats, Gray Loop	#10612	\$189.95/set
w/ Bench Seats, Daytona, Blue....	#11954	\$458.95/set
w/ Bench Seats, Daytona, Gray ...	#11955	\$458.95/set
w/ Bench Seats, Daytona, Turq....	#11956	\$458.95/set
w/ Bench Seats, Daytona, Brown	#11957	\$458.95/set
w/ Bench Seats, Daytona, Dark Green			
.....	#11958	\$458.95/set
w/ Bench Seats, Daytona, Lt Blue	#11991	\$458.95/set
w/ Bench Seats, Daytona, Lt Green			
.....	#11992	\$458.95/set
w/ Bench Seats, Daytona, Black..	#11999	\$458.95/set

1955 CONVERTIBLE

w/ Bench Seats, Red Plush	#10623	\$189.95/set
w/ Bench Seats, Blue Plush.....	#10624	\$189.95/set
w/ Bench Seats, Black Plush.....	#10625	\$189.95/set
w/ Bench Seats, Dark Blue Plush	#10626	\$189.95/set
w/ Bench Seats, Gray Plush	#10627	\$189.95/set
w/ Bench Seats, Red Loop	#10628	\$189.95/set
w/ Bench Seats, Blue Loop	#10629	\$189.95/set
w/ Bench Seats, Black Loop	#10630	\$189.95/set
w/ Bench Seats, Dark Blue Loop	#10631	\$189.95/set
w/ Bench Seats, Gray Loop	#10632	\$189.95/set
w/ Bench Seats, Daytona, Red....	#11969	\$458.95/set
w/ Bench Seats, Daytona, Dk Blue	#11970	\$458.95/set
w/ Bench Seats, Daytona, Gray ...	#11971	\$458.95/set
w/ Bench Seats, Daytona, Dark Green			
.....	#11972	\$458.95/set
w/ Bench Seats, Daytona, Brown	#11973	\$458.95/set
w/ Bench Seats, Daytona, Turq....	#11974	\$458.95/set
w/ Bucket Seats, Red Plush	#10633	\$189.95/set
w/ Bucket Seats, Blue Plush	#10634	\$189.95/set
w/ Bucket Seats, Black Plush	#10635	\$189.95/set
w/ Bucket Seats, Dark Blue Plush	#10636	\$189.95/set
w/ Bucket Seats, Gray Plush	#10637	\$189.95/set
w/ Bucket Seats, Red Loop	#10638	\$189.95/set
w/ Bucket Seats, Blue Loop	#10639	\$189.95/set
w/ Bucket Seats, Black Loop	#10640	\$189.95/set
w/ Bucket Seats, Dark Blue Loop	#10641	\$189.95/set
w/ Bucket Seats, Gray Loop	#10642	\$189.95/set

 WARNING! Products on these pages may contain chemicals known to the State Of California to cause cancer and/or birth defects or reproductive harm. www.p65warnings.ca.gov



1955 NOMAD

- w/ Bucket Seats, Black Loop #15162\$189.95/set
- w/ Bucket Seats, Blue Loop #15163\$189.95/set
- w/ Bucket Seats, Dark Blue Loop #15164\$189.95/set
- w/ Bucket Seats, Gray Loop..... #15165\$189.95/set
- w/ Bucket Seats, Red Loop..... #15166\$189.95/set
- w/ Bucket Seats, Black Plush #15167\$189.95/set
- w/ Bucket Seats, Blue Plush #15168\$189.95/set
- w/ Bucket Seats, Dark Blue Plush#15169\$189.95/set
- w/ Bucket Seats, Gray Plush..... #15170\$189.95/set
- w/ Bucket Seats, Red Plush #15171\$189.95/set
- w/ Bench Seats, Red Plush #10643\$189.95/set
- w/ Bench Seats, Blue Plush..... #10644\$189.95/set
- w/ Bench Seats, Black Plush..... #10645\$189.95/set
- w/ Bench Seats, Dark Blue Plush #10646\$189.95/set
- w/ Bench Seats, Gray Plush #10647\$189.95/set
- w/ Bench Seats, Red Loop #10648\$189.95/set
- w/ Bench Seats, Blue Loop #10649\$189.95/set
- w/ Bench Seats, Black Loop #10650\$189.95/set
- w/ Bench Seats, Dark Blue Loop . #10651\$189.95/set
- w/ Bench Seats, Gray Loop..... #10652\$189.95/set
- w/ Bench Seats, Daytona, Light Green #11975\$458.95/set
- w/ Bench Seats, Daytona, Brown #11976\$458.95/set
- w/ Bench Seats, Daytona, Turq... #11977\$458.95/set
- w/ Bench Seats, Daytona, Gray ... #11978\$458.95/set
- w/ Bench Seats, Daytona, Blue.... #11979\$458.95/set
- w/ Bench Seats, Daytona, Red.... #11980\$458.95/set
- w/ Bench Seats, Daytona, Black... #12022\$458.95/set
- Daytona Cargo Area, Light Green #11985\$312.95/set
- Daytona Cargo Area, Brown..... #11986\$312.95/set
- Daytona Cargo Area, Turquoise ... #11987\$312.95/set
- Daytona Cargo Area, Gray #11988\$312.95/set
- Daytona Cargo Area, Light Blue... #11989\$312.95/set
- Daytona Cargo Area, Red #11990\$312.95/set

1955 2-DOOR WAGON

- w/ Bucket Seats, Black Loop #15162\$189.95/set
- w/ Bucket Seats, Blue Loop #15163\$189.95/set
- w/ Bucket Seats, Dark Blue Loop #15164\$189.95/set
- w/ Bucket Seats, Gray Loop..... #15165\$189.95/set
- w/ Bucket Seats, Red Loop..... #15166\$189.95/set
- w/ Bucket Seats, Black Plush #15167\$189.95/set
- w/ Bucket Seats, Blue Plush #15168\$189.95/set

1955 2-DOOR WAGON

- w/ Bucket Seats, Dark Blue Plush#15169\$189.95/set
- w/ Bucket Seats, Gray Plush..... #15170\$189.95/set
- w/ Bucket Seats, Red Plush #15171\$189.95/set
- w/ Bench Seats, Red Plush #10643\$189.95/set
- w/ Bench Seats, Blue Plush..... #10644\$189.95/set
- w/ Bench Seats, Black Plush..... #10645\$189.95/set
- w/ Bench Seats, Dark Blue Plush #10646\$189.95/set
- w/ Bench Seats, Gray Plush #10647\$189.95/set
- w/ Bench Seats, Red Loop #10648\$189.95/set
- w/ Bench Seats, Blue Loop #10649\$189.95/set
- w/ Bench Seats, Black Loop #10650\$189.95/set
- w/ Bench Seats, Dark Blue Loop . #10651\$189.95/set
- w/ Bench Seats, Gray Loop..... #10652\$189.95/set
- w/ Bench Seats, Daytona, Black.. #12000\$458.95/set
- w/ Bench Seats, Daytona, Gray .#12001\$458.95/set
- w/ Bench Seats, Daytona, Light Green #11975\$458.95/set
- w/ Bench Seats, Daytona, Brown #11976\$458.95/set
- w/ Bench Seats, Daytona, Gray ... #11978\$458.95/set
- w/ Bench Seats, Daytona, Blue... #11979\$458.95/set
- w/ Bench Seats, Daytona, Red.... #11980\$458.95/set
- w/ Bench Seats, Daytona, Black.. #12022\$458.95/set
- w/ Bench Seats, Daytona, Turq... #11977\$458.95/set
- Daytona Cargo Area, Light Green #11985\$312.95/set

1955 4-DOOR WAGON

- Red Plush w/ Bench Seats #12054\$189.95/set
- Blue Plush w/ Bench Seats..... #12055\$189.95/set
- Black Plush w/ Bench Seats..... #12056\$189.95/set
- Dark Blue Plush w/ Bench Seats . #12057\$189.95/set
- Gray Plush w/ Bench Seats #12058\$189.95/set
- Red Loop w/ Bench Seats #12059\$189.95/set
- Blue Loop w/ Bench Seats #12060\$189.95/set
- Black Loop w/ Bench Seats #12061\$189.95/set
- Dark Blue Loop w/ Bench Seats.. #12062\$189.95/set
- Gray Loop w/ Bench Seats..... #12063\$189.95/set
- w/ Bench Seats, Daytona, Beige.. #11965\$458.95/set
- w/ Bench Seats, Daytona, Red.... #11966\$458.95/set
- Daytona Cargo Area, Beige #11967\$312.95/set
- Daytona Cargo Area, Blue #11968\$312.95/set
- w/ Bench Seats, Daytona, Lt Blue#11996\$458.95/set
- w/ Bench Seats, Daytona, Light Green #11997\$458.95/set
- w/ Bench Seats, Daytona, Brown #11998\$458.95/set



LOOP

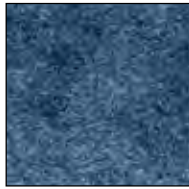

PLUSH

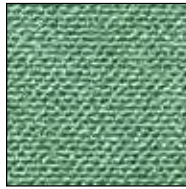

DAYTONA
WEAVE

1956 2-DOOR SEDAN

- w/ Bench Seats, Red Plush #10673 \$189.95/set
- w/ Bench Seats, Blue Plush..... #10674 \$189.95/set
- w/ Bench Seats, Black Plush..... #10675 \$189.95/set
- w/ Bench Seats, Dark Blue Plush #10676 \$189.95/set
- w/ Bench Seats, Gray Plush #10677 \$189.95/set
- w/ Bench Seats, Red Loop #10678 \$189.95/set
- w/ Bench Seats, Blue Loop #10679 \$189.95/set
- w/ Bench Seats, Black Loop #10680 \$189.95/set
- w/ Bench Seats, Dark Blue Loop. #10681 \$189.95/set
- w/ Bench Seats, Gray Loop #10682 \$189.95/set
- w/ Bench Seats, Daytona, Light Green
..... #11984 \$458.95/set
- w/ Bench Seats, Daytona, Light Blue
..... #11983 \$458.95/set
- w/ Bench Seats, Daytona, Black.. #11995 \$458.95/set
- w/ Bench Seats, Daytona, Turq... #11951 \$458.95/set
- w/ Bench Seats, Daytona, Copper
..... #12008 \$458.95/set
- w/ Bucket Seats, Red Plush #10593A..... \$189.95/set
- w/ Bucket Seats, Blue Plush #10594A..... \$189.95/set
- w/ Bucket Seats, Black Plush #10595A..... \$189.95/set
- w/ Bucket Seats, Dark Blue Plush#10596A..... \$189.95/set
- w/ Bucket Seats, Gray Plush..... #10597A..... \$189.95/set
- w/ Bucket Seats, Red Loop..... #10598A..... \$189.95/set
- w/ Bucket Seats, Blue Loop #10599A..... \$189.95/set
- w/ Bucket Seats, Black Loop #10600A..... \$189.95/set
- w/ Bucket Seats, Dark Blue Loop #10601A..... \$189.95/set
- w/ Bucket Seats, Gray Loop..... #10602A..... \$189.95/set

1956 2-DOOR HARDTOP

- w/ Bench Seats, Red Plush #10653 \$189.95/set
- w/ Bench Seats, Blue Plush..... #10654 \$189.95/set
- w/ Bench Seats, Black Plush..... #10655 \$189.95/set
- w/ Bench Seats, Dark Blue Plush #10656 \$189.95/set
- w/ Bench Seats, Gray Plush #10657 \$189.95/set
- w/ Bench Seats, Red Loop #10658 \$189.95/set
- w/ Bench Seats, Blue Loop #10659 \$189.95/set
- w/ Bench Seats, Black Loop #10660 \$189.95/set
- w/ Bench Seats, Dark Blue Loop. #10661 \$189.95/set
- w/ Bench Seats, Gray Loop..... #10662 \$189.95/set
- w/ Bench Seats, Daytona, Black.. #11964 \$458.95/set
- w/ Bench Seats, Daytona, Turq. .. #11961 \$458.95/set
- w/ Bench Seats, Daytona, Light Green
..... #11963 \$458.95/set
- w/ Bench Seats, Daytona, Light Blue
..... #11959 \$458.95/set
- w/ Bench Seats, Daytona, Copper
..... #12036 \$458.95/set
- w/ Bench Seats, Daytona, Red.... #11962 \$429.95/set
- w/ Bucket Seats, Red Plush #10663 \$189.95/set
- w/ Bucket Seats, Blue Plush #10664 \$189.95/set
- w/ Bucket Seats, Black Plush #10665 \$189.95/set
- w/ Bucket Seats, Dark Blue Plush#10666 \$189.95/set
- w/ Bucket Seats, Gray Plush..... #10667 \$189.95/set



1956 2-DOOR HARDTOP

- w/ Bucket Seats, Red Loop..... #10668 \$189.95/set
- w/ Bucket Seats, Blue Loop #10669 \$189.95/set
- w/ Bucket Seats, Black Loop #10670 \$189.95/set
- w/ Bucket Seats, Dark Blue Loop #10671 \$189.95/set
- w/ Bucket Seats, Gray Loop..... #10672 \$189.95/set

1956 4-DOOR SEDAN

- w/ Bench Seats, Red Plush #10693 \$189.95/set
- w/ Bench Seats, Blue Plush..... #10694 \$189.95/set
- w/ Bench Seats, Black Plush..... #10695 \$189.95/set
- w/ Bench Seats, Dark Blue Plush #10696 \$189.95/set
- w/ Bench Seats, Gray Plush #10697 \$189.95/set
- w/ Bench Seats, Red Loop #10698 \$189.95/set
- w/ Bench Seats, Blue Loop #10699 \$189.95/set
- w/ Bench Seats, Black Loop #10700 \$189.95/set
- w/ Bench Seats, Dark Blue Loop. #10701 \$189.95/set
- w/ Bench Seats, Gray Loop..... #10702 \$189.95/set
- w/ Bench Seats, Daytona, Black.. #11999 \$458.95/set
- w/ Bench Seats, Daytona, Light Blue
..... #11991 \$458.95/set
- w/ Bench Seats, Daytona, Light Green
..... #11992 \$458.95/set
- w/ Bench Seats, Daytona, Turq. .. #11956 \$458.95/set
- w/ Bench Seats, Daytona, Copper
..... #12009 \$458.95/set

1956 4-DOOR HARDTOP

- w/ Bench Seats, Red Plush #10683 \$189.95/set
- w/ Bench Seats, Blue Plush..... #10684 \$189.95/set
- w/ Bench Seats, Black Plush..... #10685 \$189.95/set
- w/ Bench Seats, Dark Blue Plush #10686 \$189.95/set
- w/ Bench Seats, Gray Plush #10687 \$189.95/set
- w/ Bench Seats, Red Loop #10688 \$189.95/set
- w/ Bench Seats, Blue Loop #10689 \$189.95/set
- w/ Bench Seats, Black Loop #10690 \$189.95/set
- w/ Bench Seats, Dark Blue Loop. #10691 \$189.95/set
- w/ Bench Seats, Gray Loop..... #10692 \$189.95/set
- w/ Bench Seats, Daytona, Black.. #12002 \$458.95/set
- w/ Bench Seats, Daytona, Turq. .. #12003 \$458.95/set
- w/ Bench Seats, Daytona, Lt.Gr. #12004 \$458.95/set
- w/ Bench Seats, Daytona, Dark Blue
..... #12005 \$458.95/set
- w/ Bench Seats, Daytona, Copper
..... #12006 \$458.95/set
- w/ Bench Seats, Daytona, Red.... #12007 \$458.95/set

1956 CONVERTIBLE

w/ Bench Seats, Red Plush	#10703	\$189.95/set
w/ Bench Seats, Blue Plush.....	#10704	\$189.95/set
w/ Bench Seats, Black Plush.....	#10705	\$189.95/set
w/ Bench Seats, Dark Blue Plush	#10706	\$189.95/set
w/ Bench Seats, Gray Plush	#10707	\$189.95/set
w/ Bench Seats, Red Loop	#10708	\$189.95/set
w/ Bench Seats, Blue Loop	#10709	\$189.95/set
w/ Bench Seats, Black Loop	#10710	\$189.95/set
w/ Bench Seats, Dark Blue Loop .	#10711	\$189.95/set
w/ Bench Seats, Gray Loop.....	#10712	\$189.95/set
w/ Bench Seats, Daytona, Black..	#12019	\$458.95/set
w/ Bench Seats, Daytona, Red ...	#11969	\$458.95/set
w/ Bench Seats, Daytona, Turq. ..	#11974	\$458.95/set
w/ Bench Seats, Daytona, Dark Green			
.....	#11972	\$458.95/set
w/ Bench Seats, Daytona, Dark Blue			
.....	#11970	\$458.95/set
w/ Bench Seats, Daytona, Copper			
.....	#12020	\$458.95/set
w/ Bucket Seats, Red Plush	#10713	\$189.95/set
w/ Bucket Seats, Blue Plush	#10714	\$189.95/set
w/ Bucket Seats, Black Plush	#10715	\$189.95/set
w/ Bucket Seats, Dark Blue Plush	#10716	\$189.95/set
w/ Bucket Seats, Gray Plush.....	#10717	\$189.95/set
w/ Bucket Seats, Red Loop	#10718	\$189.95/set
w/ Bucket Seats, Blue Loop	#10719	\$189.95/set
w/ Bucket Seats, Black Loop	#10720	\$189.95/set
w/ Bucket Seats, Dark Blue Loop	#10721	\$189.95/set
w/ Bucket Seats, Gray Loop.....	#10722	\$189.95/set

1956 NOMAD

w/ Bench Seats, Red Plush	#10643A	\$189.95/set
w/ Bench Seats, Blue Plush.....	#10644A	\$189.95/set
w/ Bench Seats, Black Plush.....	#10645A	\$189.95/set
w/ Bench Seats, Dark Blue Plush	#10646A	\$189.95/set
w/ Bench Seats, Gray Plush	#10647A	\$189.95/set
w/ Bench Seats, Red Loop	#10648A	\$189.95/set
w/ Bench Seats, Blue Loop	#10649A	\$189.95/set
w/ Bench Seats, Black Loop	#10650A	\$189.95/set
w/ Bench Seats, Dark Blue Loop .	#10651A	\$189.95/set
w/ Bench Seats, Gray Loop.....	#10652A	\$189.95/set
w/ Bench Seats, Daytona, Light Green			
.....	#11975	\$458.95/set
w/ Bench Seats, Daytona, Dark Blue			
.....	#12021	\$458.95/set
w/ Bench Seats, Daytona, Red.....	#11980	\$458.95/set
w/ Bench Seats, Daytona, Black..	#12022	\$458.95/set
w/ Bench Seats, Daytona, Copper			
.....	#12023	\$458.95/set
w/ Bench Seats, Daytona, Turq....	#11977	\$458.95/set
w/ Bench Seats, Daytona, Light Blue			
.....	#14090	\$424.95/set
w/ Bucket Seats, Black Loop	#15172	\$189.95/set
w/ Bucket Seats, Blue Loop	#15173	\$189.95/set
w/ Bucket Seats, Dark Blue Loop			
.....	#15174	\$189.95/set
w/ Bucket Seats, Gray Loop.....	#15175	\$189.95/set
w/ Bucket Seats, Red Loop	#15176	\$189.95/set
w/ Bucket Seats, Black Plush	#15177	\$189.95/set
w/ Bucket Seats, Blue Plush	#15178	\$189.95/set
w/ Bucket Seats, Dark Blue Plush	#15179	\$189.95/set
w/ Bucket Seats, Gray Plush.....	#15180	\$189.95/set
w/ Bucket Seats, Red Plush	#15181	\$189.95/set

1956 NOMAD CONTINUED

Daytona Cargo Area, Lt. Green	#12015	\$312.95/set
Daytona Cargo Area, Dk. Blue.....	#12014	\$312.95/set
Daytona Cargo Area, Red	#12018	\$312.95/set
Daytona Cargo Area, Black	#12013	\$312.95/set
Daytona Cargo Area, Copper	#12017	\$312.95/set
Daytona Cargo Area, Turq.	#12016	\$312.95/set

1956 2-DOOR WAGON

w/ Bench Seats, Red Plush	#10643A	\$189.95/set
w/ Bench Seats, Blue Plush.....	#10644A	\$189.95/set
w/ Bench Seats, Black Plush.....	#10645A	\$189.95/set
w/ Bench Seats, Dark Blue Plush	#10646A	\$189.95/set
w/ Bench Seats, Gray Plush	#10647A	\$189.95/set
w/ Bench Seats, Red Loop	#10648A	\$189.95/set
w/ Bench Seats, Blue Loop	#10649A	\$189.95/set
w/ Bench Seats, Black Loop	#10650A	\$189.95/set
w/ Bench Seats, Dark Blue Loop .	#10651A	\$189.95/set
w/ Bench Seats, Gray Loop.....	#10652A	\$189.95/set
w/ Bench Seats, Daytona, Lt. Green			
.....	#11975	\$458.95/set
w/ Bench Seats, Daytona, Dark Blue			
.....	#12021	\$458.95/set
w/ Bench Seats, Daytona, Red.....	#11980	\$458.95/set
w/ Bench Seats, Daytona, Black..	#12022	\$458.95/set
w/ Bench Seats, Daytona, Copper			
.....	#12023	\$458.95/set
w/ Bench Seats, Daytona, Turq....	#11977	\$458.95/set
w/ Bench Seats, Daytona, Lt. Blue			
.....	#14090	\$424.95/set
w/ Bucket Seats, Black Loop	#15172	\$189.95/set
w/ Bucket Seats, Blue Loop	#15173	\$189.95/set
w/ Bucket Seats, Dark Blue Loop			
.....	#15174	\$189.95/set
w/ Bucket Seats, Gray Loop.....	#15175	\$189.95/set
w/ Bucket Seats, Red Loop	#15176	\$189.95/set
w/ Bucket Seats, Black Plush	#15177	\$189.95/set
w/ Bucket Seats, Blue Plush	#15178	\$189.95/set
w/ Bucket Seats, Dark Blue Plush	#15179	\$189.95/set
w/ Bucket Seats, Gray Plush.....	#15180	\$189.95/set
w/ Bucket Seats, Red Plush	#15181	\$189.95/set

1956 4-DOOR WAGON

w/ Bench Seats, Red Plush	#12054A	\$189.95/set
w/ Bench Seats, Blue Plush.....	#12055A	\$189.95/set
w/ Bench Seats, Black Plush.....	#12056A	\$189.95/set
w/ Bench Seats, Dark Blue Plush	#12057A	\$189.95/set
w/ Bench Seats, Gray Plush	#12058A	\$189.95/set
w/ Bench Seats, Red Loop	#12059A	\$189.95/set
w/ Bench Seats, Blue Loop	#12060A	\$189.95/set
w/ Bench Seats, Black Loop	#12061A	\$189.95/set
w/ Bench Seats, Dark Blue Loop .	#12062A	\$189.95/set
w/ Bench Seats, Gray Loop.....	#12063A	\$189.95/set
w/ Bench Seats, Daytona, Light Blue			
.....	#11996	\$458.95/set
w/ Bench Seats, Daytona, Light Green			
.....	#11997	\$458.95/set
w/ Bench Seats, Daytona, Black..	#12000	\$458.95/set
w/ Bench Seats, Daytona, Dark Blue			
.....	#12010	\$458.95/set
w/ Bench Seats, Daytona, Turq....	#12011	\$458.95/set
w/ Bench Seats, Daytona, Copper			
.....	#12012	\$458.95/set
w/ Bench Seats, Daytona, Red.....	#11966	\$458.95/set

1957 2-DOOR HARDTOP

w/ Bench Seats, Red Plush	#10723	\$189.95/set
w/ Bench Seats, Blue Plush.....	#10724	\$189.95/set
w/ Bench Seats, Black Plush.....	#10725	\$189.95/set
w/ Bench Seats, Dark Blue Plush	#10726	\$189.95/set
w/ Bench Seats, Gray Plush	#10727	\$189.95/set
w/ Bench Seats, Red Loop	#10728	\$189.95/set
w/ Bench Seats, Blue Loop	#10729	\$189.95/set
w/ Bench Seats, Black Loop	#10730	\$189.95/set
w/ Bench Seats, Dark Blue Loop	#10731	\$189.95/set
w/ Bench Seats, Gray Loop	#10732	\$189.95/set
w/ Bench Seats, Turq Loop	#10803	\$189.95/set
w/ Bench Seats, Copper Loop	#10804	\$189.95/set
w/ Bench Seats, Green Loop.....	#10805	\$189.95/set
w/ Bucket Seats, Red Plush	#10733	\$189.95/set
w/ Bucket Seats, Blue Plush	#10734	\$189.95/set
w/ Bucket Seats, Black Plush	#10735	\$189.95/set
w/ Bucket Seats, Dark Blue Plush	#10736	\$189.95/set
w/ Bucket Seats, Gray Plush	#10737	\$189.95/set
w/ Bucket Seats, Red Loop	#10738	\$189.95/set
w/ Bucket Seats, Blue Loop	#10739	\$189.95/set
w/ Bucket Seats, Black Loop	#10740	\$189.95/set
w/ Bucket Seats, Dark Blue Loop	#10741	\$189.95/set
w/ Bucket Seats, Gray Loop.....	#10742	\$189.95/set

1957 2-DOOR SEDAN

w/ Bench Seats, Red Plush	#10743	\$189.95/set
w/ Bench Seats, Blue Plush.....	#10744	\$189.95/set
w/ Bench Seats, Black Plush.....	#10745	\$189.95/set
w/ Bench Seats, Dark Blue Plush	#10746	\$189.95/set
w/ Bench Seats, Gray Plush	#10747	\$189.95/set
w/ Bench Seats, Red Loop	#10748	\$189.95/set
w/ Bench Seats, Blue Loop	#10749	\$189.95/set
w/ Bench Seats, Black Loop	#10750	\$189.95/set
w/ Bench Seats, Dark Blue Loop	#10751	\$189.95/set
w/ Bench Seats, Gray Loop.....	#10752	\$189.95/set
w/ Bench Seats, Turquoise Loop	#10806	\$189.95/set
w/ Bench Seats, Copper Loop	#10807	\$189.95/set
w/ Bench Seats, Green Loop.....	#10808	\$189.95/set
w/ Bucket Seats, Red Plush	#10753	\$189.95/set
w/ Bucket Seats, Blue Plush	#10754	\$189.95/set
w/ Bucket Seats, Black Plush	#10755	\$189.95/set
w/ Bucket Seats, Dark Blue Plush	#10756	\$189.95/set
w/ Bucket Seats, Gray Plush	#10757	\$189.95/set
w/ Bucket Seats, Red Loop	#10758	\$189.95/set
w/ Bucket Seats, Blue Loop	#10759	\$189.95/set
w/ Bucket Seats, Black Loop	#10760	\$189.95/set
w/ Bucket Seats, Dark Blue Loop	#10761	\$189.95/set
w/ Bucket Seats, Gray Loop.....	#10762	\$189.95/set

1957 4-DOOR HARDTOP

w/ Bench Seats, Red Plush	#10763	\$189.95/set
w/ Bench Seats, Blue Plush.....	#10764	\$189.95/set
w/ Bench Seats, Black Plush.....	#10765	\$189.95/set
w/ Bench Seats, Dark Blue Plush	#10766	\$189.95/set
w/ Bench Seats, Gray Plush	#10767	\$189.95/set
w/ Bench Seats, Red Loop	#10768	\$189.95/set
w/ Bench Seats, Blue Loop	#10769	\$189.95/set
w/ Bench Seats, Black Loop	#10770	\$189.95/set
w/ Bench Seats, Dark Blue Loop	#10771	\$189.95/set
w/ Bench Seats, Gray Loop.....	#10772	\$189.95/set
w/ Bench Seats, Turquoise Loop	#10809	\$189.95/set
w/ Bench Seats, Copper Loop	#10810	\$189.95/set
w/ Bench Seats, Green Loop.....	#10811	\$189.95/set

1957 4-DOOR SEDAN

w/ Bench Seats, Red Plush	#10773	\$189.95/set
w/ Bench Seats, Blue Plush.....	#10774	\$189.95/set
w/ Bench Seats, Black Plush.....	#10775	\$189.95/set
w/ Bench Seats, Dark Blue Plush	#10776	\$189.95/set
w/ Bench Seats, Gray Plush	#10777	\$189.95/set
w/ Bench Seats, Red Loop	#10778	\$189.95/set
w/ Bench Seats, Blue Loop	#10779	\$189.95/set
w/ Bench Seats, Black Loop	#10780	\$189.95/set
w/ Bench Seats, Dark Blue Loop	#10781	\$189.95/set
w/ Bench Seats, Gray Loop.....	#10782	\$189.95/set
w/ Bench Seats, Turquoise Loo ...	#10812	\$189.95/set
w/ Bench Seats, Copper Loop	#10813	\$189.95/set
w/ Bench Seats, Green Loop.....	#10814	\$189.95/set

1957 CONVERTIBLE

w/ Bench Seats, Red Plush	#10783	\$189.95/set
w/ Bench Seats, Blue Plush.....	#10784	\$189.95/set
w/ Bench Seats, Black Plush.....	#10785	\$189.95/set
w/ Bench Seats, Dark Blue Plush	#10786	\$189.95/set
w/ Bench Seats, Gray Plush	#10787	\$189.95/set
w/ Bench Seats, Red Loop	#10788	\$189.95/set
w/ Bench Seats, Blue Loop	#10789	\$189.95/set
w/ Bench Seats, Black Loop	#10790	\$189.95/set
w/ Bench Seats, Dark Blue Loop	#10791	\$189.95/set
w/ Bench Seats, Gray Loop.....	#10792	\$189.95/set
w/ Bench Seats, Turquoise Loop	#10815	\$189.95/set
w/ Bench Seats, Copper Loop	#10816	\$189.95/set
w/ Bench Seats, Green Loop.....	#10817	\$189.95/set
w/ Bench Seats, Copper Loop	#17943	\$189.95/set
w/ Bucket Seats, Red Plush	#10793	\$189.95/set
w/ Bucket Seats, Blue Plush	#10794	\$189.95/set
w/ Bucket Seats, Black Plush	#10795	\$189.95/set
w/ Bucket Seats, Dark Blue Plush	#10796	\$189.95/set
w/ Bucket Seats, Gray Plush.....	#10797	\$189.95/set
w/ Bucket Seats, Red Loop.....	#10798	\$189.95/set
w/ Bucket Seats, Blue Loop	#10799	\$189.95/set
w/ Bucket Seats, Black Loop	#10800	\$189.95/set
w/ Bucket Seats, Dark Blue Loop	#10801	\$189.95/set
w/ Bucket Seats, Gray Loop.....	#10802	\$189.95/set

1957 NOMAD

w/ Bench Seats, Red Plush	#10643B	\$189.95/set
w/ Bench Seats, Blue Plush.....	#10644B	\$189.95/set
w/ Bench Seats, Black Plush.....	#10645B	\$189.95/set
w/ Bench Seats, Dark Blue Plush	#10646B	\$189.95/set
w/ Bench Seats, Gray Plush	#10647B	\$189.95/set
w/ Bench Seats, Red Loop	#10648B	\$189.95/set
w/ Bench Seats, Blue Loop	#10649B	\$189.95/set
w/ Bench Seats, Black Loop,	#10650B	\$189.95/set
w/ Bench Seats, Dark Blue Loop	#10651B	\$189.95/set
w/ Bench Seats, Gray Loop.....	#10652B	\$189.95/set
w/ Bench Seats, Turquoise Loop	#14091	\$189.95/set
w/ Bench Seats, Copper Loop	#14098	\$189.95/set
w/ Bench Seats, Green Loop.....	#17945	\$189.95/set
w/ Bucket Seats, Black Plush	#15187	\$189.95/set
w/ Bucket Seats, Blue Plush	#15188	\$189.95/set
w/ Bucket Seats, Dark Blue Plush	#15189	\$189.95/set
w/ Bucket Seats, Gray Plush.....	#15190	\$189.95/set



LOOP



PLUSH



DAYTONA WEAVE

WARNING! Products on these pages may contain chemicals known to the State Of California to cause cancer and/or birth defects or reproductive harm. www.p65warnings.ca.gov

1957 NOMAD CONTINUED

w/ Bucket Seats, Black Loop	#19125\$219.95/set
w/ Bucket Seats, Blue Loop	#19126\$219.95/set
w/ Bucket Seats, Dark Blue Loop	#19127\$219.95/set
w/ Bucket Seats, Gray Loop.....	#19128\$219.95/set
w/ Bucket Seats, Red Loop.....	#19129\$219.95/set
w/ Bucket Seats, Turquoise Loop	#19130\$219.95/set
w/ Bucket Seats, Copper Loop	#19131\$219.95/set
w/ Bucket Seats, Green Loop	#19132\$219.95/set

1957 2-DOOR WAGON

w/ Bench Seats, Red Plush	#10643B\$189.95/set
w/ Bench Seats, Blue Plush.....	#10644B\$189.95/set
w/ Bench Seats, Black Plush.....	#10645B\$189.95/set
w/ Bench Seats, Dark Blue Plush	#10646B\$189.95/set
w/ Bench Seats, Gray Plush	#10647B\$189.95/set
w/ Bench Seats, Red Loop	#10648B\$189.95/set
w/ Bench Seats, Blue Loop	#10649B\$189.95/set
w/ Bench Seats, Black Loop	#10650B\$189.95/set
w/ Bench Seats, Dark Blue Loop	#10651B\$189.95/set
w/ Bench Seats, Gray Loop.....	#10652B\$189.95/set
w/ Bench Seats, Turquoise, Loop	#14091\$189.95/set
w/ Bench Seats, Copper, Loop.....	#14098\$189.95/set
w/ Bucket Seats, Black Plush	#15187\$189.95/set
w/ Bucket Seats, Blue Plush	#15188\$189.95/set
w/ Bucket Seats, Dark Blue Plush.....	#15189\$189.95/set
w/ Bucket Seats, Gray Plush.....	#15190\$189.95/set
w/ Bucket Seats, Black Loop	#19125\$219.95/set
w/ Bucket Seats, Blue Loop	#19126\$219.95/set
w/ Bucket Seats, Dark Blue Loop	#19127\$219.95/set
w/ Bucket Seats, Gray Loop.....	#19128\$219.95/set
w/ Bucket Seats, Red Loop.....	#19129\$219.95/set
w/ Bucket Seats, Turquoise Loop	#19130\$219.95/set
w/ Bucket Seats, Copper Loop	#19131\$219.95/set
w/ Bucket Seats, Green Loop	#19132\$219.95/set

1957 4-DOOR WAGON

w/ Bench Seats, Red Plush	#12054B\$189.95/set
w/ Bench Seats, Blue Plush.....	#12055B\$189.95/set
w/ Bench Seats, Black Plush.....	#12056B\$189.95/set
w/ Bench Seats, Dark Blue Plush	#12057B\$189.95/set
w/ Bench Seats, Gray Plush	#12058B\$189.95/set
w/ Bench Seats, Red Loop	#12059B\$189.95/set
w/ Bench Seats, Blue Loop	#12060B\$189.95/set
w/ Bench Seats, Black Loop	#12061B\$189.95/set
w/ Bench Seats, Dark Blue Loop	#12062B\$189.95/set
w/ Bench Seats, Gray Loop.....	#12063B\$189.95/set
w/ Bench Seats, Green Loop.....	#17946\$189.95/set
w/ Bench Seats, Copper Loop	#17947\$189.95/set

ONE PIECE MOLDED CARPET SETS FOR 1955-57 2 & 4 DOOR

Black Loop	#14958\$189.95/set
Blue Loop	#14959\$189.95/set
Dark Blue Loop.....	#14960\$189.95/set
Gray Loop.....	#14961\$189.95/set
Red Loop.....	#14962\$189.95/set
Turquoise Loop	#14963\$189.95/set
Black Plush	#14964\$189.95/set
Blue Plush	#14965\$189.95/set
Dark Blue Plush	#14966\$189.95/set
Gray Plush	#14967\$189.95/set
Red Plush	#14968\$189.95/set

FIVE PIECE CARGO CARPET SETS FOR 1955-57 NOMADS AND WAGONS:

Red, Plush	#14071\$120.95/set
Blue, Plush	#14072\$120.95/set
Black, Plush	#14073\$120.95/set
Dark Blue, Plush	#14074\$120.95/set
Gray, Plush	#14075\$120.95/set
Red, Loop.....	#14076\$120.95/set
Blue, Loop	#14077\$120.95/set
Black, Loop	#14078\$120.95/set
Dark Blue, Loop.....	#14079\$120.95/set
Gray, Loop	#14080\$120.95/set
Turquoise, Loop	#14081\$120.95/set
Daytona, Gray	#14082\$279.95/set
Daytona, Black.....	#14083\$279.95/set
Daytona, Dark Blue	#14084\$279.95/set
Daytona, Light Green	#14085\$279.95/set
Daytona, Dark Green.....	#14086\$279.95/set
Daytona, Turquoise	#14087\$279.95/set
Daytona, Copper.....	#14088\$279.95/set
Daytona, Red	#14089\$279.95/set

FIVE PIECE VINYL CARGO DECK MATERIALS FOR NOMADS & WAGONS

An excellent reproduction of the original Cargo area covering.

1955 Beige.....	#15102\$312.95/ea.
1955 Red.....	#12932\$312.95/ea.
1955 Medium Green	#12933\$312.95/ea.
1955 Blue	#12934\$312.95/ea.
1955 Turquoise.....	#12935\$312.95/ea.
1955 Grey.....	#12936\$312.95/ea.
1955 Brown	#12937\$312.95/ea.
1955-57 Yellow	#17948\$329.95/ea.
1956 Red.....	#15103\$312.95/ea.
1956 Medium Green	#15104\$312.95/ea.
1956-57 Medium Blue.....	#12940\$312.95/ea.
1956-57 Copper	#12942\$312.95/ea.
1956-57 Black	#12943\$312.95/ea.
1957 Red.....	#12938\$312.95/ea.
1957 Medium Green	#12939\$312.95/ea.
1957 Charcoal	#15105\$312.95/ea.
1957 Turquoise.....	#12941\$312.95/ea.



LOOP

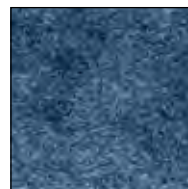

PLUSH

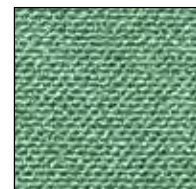

DAYTONA WEAVE

4. Electrical & Audio

SECTION AT A GLANCE:

Battery	234
Fuse Related	239
Generators	241
Starters	242
Alternators	244
Wiring Harnesses	247
Cruise Control	252
Electronic Additions.....	253
Radio & Related	254
Speakers.....	256
Custom AutoSound	257
Antenna.....	260

OPTIMA BATTERY

The Optima red top battery is the perfect battery for your project car. It will retain it's charge for over 6 months without starting, take a full charge in 2-3/4 hours at 20-amps, last 3-4 times longer than a regular battery and is 100% maintenance free; so it never needs water and will not produce corrosion on the top posts, cables or connectors. Rated at 800 cold cranking amps. 34/78 Series. Warranty is handled by the manufacturer.



1955-71 #2581 \$219.95/ea.



TAYLOR ALUMINUM TRUNK MOUNT BATTERY BOXES

Use this NHRA approved 3-piece aluminum battery box to mount your battery anywhere or order the complete kit to relocate the battery to the trunk for better weight distribution. Battery dimensions are 13-1/2" long x 9-1/2" wide x 10" high. Optima and Odyssey boxes are slightly smaller.

- All w/ Hold Down #12993..... \$124.95/kit
- All w/ 16 ft. 1-Gauge Battery Cable #12994..... \$249.95/kit
- All for Optima & Odyssey #14249..... \$129.95/kit
- All for Optima & Odyssey w/ 1-Gauge Cable #14250..... \$264.95/kit



OPTIMA 34/78 SERIES BILLET BATTERY BOXES

These billet battery boxes by Eddie Motorsports are designed to work with group 34/78 sized standard Optima batteries. Some minor modifications to the original battery box may be required.

- 1955-57 Polished..... #16250..... \$110.95/ea.
- 1955-57 Flat Black..... #16251 \$118.95/ea.



TAYLOR TRUNK MOUNT BATTERY BOXES

Battery trunk mount kits come with all the needed hardware to easily relocate your battery to the trunk. Battery tray is 13" x 7-1/4".

- All w/ 2-Gauge Battery Cable, Single Battery #12995..... \$129.95/set
- All w/ 1-Gauge Battery Cable, Single Battery #12996..... \$159.95/set



#18012

#18010

EDDIE MOTORSPORTS BILLET BATTERY BOXES

These billet battery boxes are machined from 6061-T6 billet aluminum and are a direct replacement for your original 1955-1956 battery box. They come with stainless steel mounting fasteners and they will clear the EMS billet hood hinges. These will work with any Group 78 side post or D34 & R34 top post battery. Firewall pinch weld and hole slotting modifications may be necessary. Fusioncoated colors available by special order, allow 2-4 weeks for delivery, numbers below are stocked.

- 1955-56 Machined, for 78 Battery #18010..... \$172.95/ea.
- 1955-56 Polished, for 78 Battery . #18011..... \$201.95/ea.
- 1955-56 Machined, for Optima..... #18012..... \$172.95/ea.
- 1955-56 Polished, for Optima #18013..... \$201.95/ea.



#311

#313

BATTERY BOXES

The battery box is the first part in any car to corrode. This sturdy reproduction is powder coated in a durable black finish and designed to endure many years of wear and tear. Order a hold-down kit and a new set of hold down pads, shown on page 236, for a complete assembly.

- 1955-56 Best..... #311..... \$38.95/ea.
- 1955-56 Good..... #16698..... \$28.95/ea.
- 1957 Best..... #313..... \$38.95/ea.
- 1957 Good..... #16699..... \$29.95/ea.



#312

#312C

BATTERY HOLD-DOWN KITS



Has corrosion done yours in? Replace it now! Includes hold-down frame, "J" bolts, and nuts. For a flashier version, the beautifully chromed, #312C and #314C are show stoppers. **Made in the USA***.

- 1955-56 Best, Black (Shown) #312* \$20.95/kit
- 1955-56 Good, Black, Frame Only #16770..... \$12.95/kit
- 1955-56 Chrome (Shown)..... #312C..... \$74.95/kit
- 1957 Best, Black..... #314* \$17.95/kit
- 1957 Chrome #314C..... \$129.95/kit



#13303

#13304

CHROME BATTERY BOXES

- 1955-56 Battery Box Only #13303..... \$129.95/ea.
- 1957 Battery Box Only #13304..... \$129.95/ea.



OPTIMA BATTERY HOLD-DOWN KIT

Fits Optima 34/78 Series batteries. Will work with original tray.

- 1955-56 Billet Aluminum w/ Hardware #15513..... \$104.95/kit

WARNING! Products on these pages may contain chemicals known to the State Of California to cause cancer and/or birth defects or reproductive harm. www.p65warnings.ca.gov



AUTO METER BATTERY EXTENDERS

These battery extenders from Auto Meter are designed to maximize the life of your standard (wet cell), AGM or gel battery and once they have fully charged the battery they change from charging amperage (1.5 or 3 amps) to a 250 milliamp current to maintain a full charge. This prevents sulfation, the main reason for premature battery failure.

- All 12V/1.5A..... #18095..... \$45.95/ea.
- All 12V/3A..... #18096..... \$59.95/ea.



BATTERYMINDER

The BatteryMINDER® is a 3-mode charger/maintainer/conditioner that extends performance and life of all types of 12 volt lead acid batteries, the perfect charger for keeping your battery in shape between show seasons. The BatteryMINDER® automatically dissolves harmful power robbing sulphation using patented high frequency technology, and it's guaranteed to increase your battery's life and performance or you get 100% of your money back from the manufacturer within one year. Includes battery clip cord set with quick connect and ring terminal cord set with quick connect.

- All..... #16628..... \$59.95/ea.

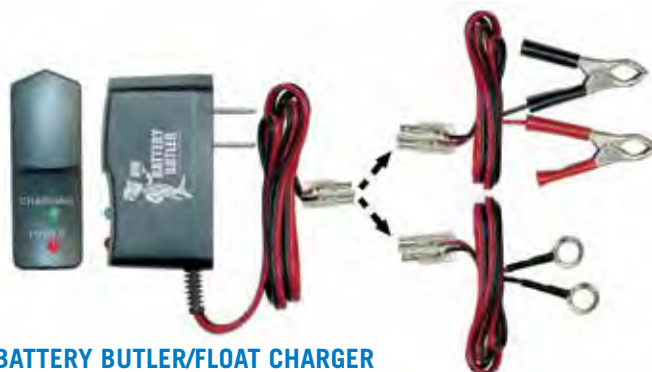

BATTERY BUTLER/FLOAT CHARGER

The battery butler battery storage charger will prevent the normal self-discharge of your battery while maintaining and extending battery life. This charger is designed for safe long term use and keeps your battery fully charged without overcharging. Just hook it up to your battery, plug the charger into any wall outlet and forget about it for weeks, months, even years.

- All..... #12813..... \$17.95/ea.



1957 BATTERY HOLD-DOWN KIT

Each plastic coated bracket has an extra smooth, glossy finish and is an identical match to the Chevy version.

- 1957..... #1784..... \$26.95/kit



BATTERY HOLD-DOWN RUBBER PADS

Fight battery acid corrosion with these handy little rubber pads. Mount them to the top of your battery to keep the metal frame away from those damaging chemicals! **Made in the USA.**

- 1938-68 #1279..... \$7.95/set



BATTERY CABLES

Sturdily constructed replacement cables in all the original lengths. Get rid of those corroded oldies.

- 1955-56 V8 & 6-Cyl.,(-)..... #132..... \$17.95/ea.
- 1955-56 V8, (+)..... #136..... \$29.95/ea.
- 1955-56 6-Cyl.,(+)..... #131A..... \$24.95/ea.
- 1957 V8 & 6-Cyl., (-)..... #133A..... \$19.95/ea.
- 1957 V8, (+)..... #137..... \$29.95/ea.
- 1957 6-Cyl., (+)..... #135..... \$29.95/ea.



TRUNK MOUNTED BATTERY CABLES

Comes with 20 feet positive and 15 feet negative 1/0 gauge cables with lugs and crimp tool.

- All Top Post Style..... #15441..... \$164.95/kit
- All Side Post Style #15442 \$159.95/kit



ORIGINAL DESIGN BATTERY CABLES

These battery cables are manufactured according to original drawings, and include the correct printed markings.

- 1955 (+) 6-Cyl. Before 8/22/55, 29"..... #18769..... \$45.95/ea.
- 1955-56 (+) 6-Cyl. After 8/22/55, 21"..... #2168..... \$45.95/ea.
- 1957 (+) 6-Cyl. #2169..... \$45.95/ea.
- 1955-56 (+) V8 #2170..... \$45.95/ea.
- 1957 (+) V8..... #2171..... \$45.95/ea.
- 1957 (-) V8 & 6-Cyl. w/ Factory A/C..... #2172..... \$45.95/ea.
- 1955-56 (-) V8 & 6-Cyl. w/ Factory A/C..... #2173..... \$45.95/ea.
- 1955-56 (-) V8 & 6-Cyl. w/o Factory A/C..... #2174..... \$45.95/ea.
- 1957 (-) 6-Cyl. w/o Factory A/C #2175..... \$45.95/ea.
- 1957 (-) V8 w/o Factory A/C..... #2176..... \$45.95/ea.



BATTERY CABLE KITS WITH CRIMP TOOL

This is an underhood 1-gauge cable kit. You get 6 foot each of red and black 1-gauge cable, terminal lugs, crimp tool and shrink tubing. Also, the negative cable has a 36 inch 10-gauge secondary cable built in. Make sure you order the correct kit for your battery. Side post or top post.

- All Top Post, 1-Gauge..... #13585..... \$115.95/ea.
- All Side Post, 1-Gauge #13586..... \$104.95/ea.

BATTERY CABLE CRIMPING STAR TOOL

Use the star tool with your vise and get a professionally strong and conductive crimp every time. Works with all sizes of battery cables.



- All..... #13587..... \$13.95/ea.

BATTERY/STARTER GROUND WASHER

This is the tanged washer that goes between the ground cable from the battery and the firewall as well as between the ground cable and the firewall on the starter ground cable. It digs into the cable ends and the face to the firewall to provide a good ground.



- 1955-56 #1280..... \$1.95/ea.

BATTERY HOLD-DOWN WASHERS

- 1955-56 #18022..... \$2.95/pr.



BATTERY

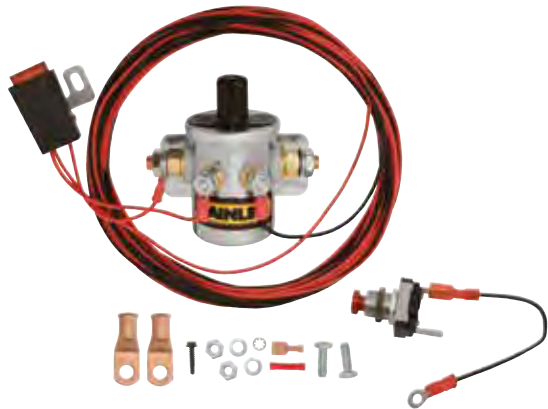

REMOTE MASTER DISCONNECT SWITCH

The Painless® remote master disconnect kit with latching solenoid is a simple and effective anti-theft deterrent for everyday vehicles. The 110-amp continuous duty solenoid is activated by an easy to hide momentary push button. No risk of accidentally draining your battery with the latching solenoid. Includes constant-hot wire for computer or radio presets.

All w/ Latching Solenoid..... #14617..... \$118.95/ea.



UNIVERSAL GAUGE DISCONNECT KIT

This kit enables you to create a completely disconnectable gauge harness for speedometer, tachometer, oil pressure, water temperature, volt, and fuel gauges. Includes terminals for blade or stud mount connections, connector and terminals for electronic speedometer connection and complete instructions.

All..... #12343..... \$99.95/kit

REMOTE MASTER DISCONNECT SWITCH KIT

This kit allows you to shut off the battery remotely. Kit contains one single pole, single throw switch with 5/16" posts rated at 110-amp continuous, 2 battery cable ends, crimping tool, enough wire to install into most applications and complete instructions.

All..... #15443..... \$103.95/kit



#18356



#15445

#15444

LIFELINE MEMORY RETENTION SYSTEMS

The Lifeline enables users of a master disconnect switch to retain a small amount of power for memory circuits common in fuel injection computers, radio presets and clocks. The Lifeline is a memory circuit retainer that will automatically reset after the electrical load is significantly reduced or if the master or remote disconnect switch has been switched to the on position.

All For Disconnect Switch..... #15444 \$29.95/ea.

All For Remote Disconnect..... #15445 \$37.95/ea.



#12369

WIRE HARNESS DISCONNECT PLUGS

Ever need to pass wires through a panel with no secure way to do it? Now offered is this disconnect system which makes gaining access or troubleshooting much easier.

All 6-Wire #18356..... \$16.95/kit

1955-57 9-Wire #12369..... \$21.95/kit

MASTER DISCONNECT SWITCH KIT

A master disconnect switch protects against theft and electrical failures. Flexible mounting locations. Switch engineered with 3/4" - 16 thread, fits 3/4" hole. Rated at 175-amp continuous or 1,000-amp intermittent. Includes protective insulated rubber boots and instructions.

All..... #15446..... \$33.95/kit



CIRKIT BOSS AUXILIARY FUSE BLOCKS

Painless Performance's Circuit Boss is a safe and right way to add additional circuits to your classic Chevy. Whether you have the latest 21-circuit wire harness or factory original wiring the Circuit Boss kits allow you to add ignition "on" and constant 12-volt circuits to your existing wiring.

- All 1-Hot, 2-Ign..... #18276.....\$79.95/kit
- All 1-Hot, 2-Ign. Weatherproof..... #18277.....\$89.95/kit
- All 3-Hot, 4-Ign..... #18278.....\$99.95/kit
- All 3-Hot, 4-Ign. Weatherproof..... #18279.....\$119.95/kit

MASTER DISCONNECT ON/OFF POSITION RING

For use with #15446 master disconnect switch.

All..... #15447 \$4.75/ea.



GROUND SPLICE SYSTEM

This ground splice system is the easiest way to assure that your dash or other system is grounded properly. The mounting tab will ground when you mount the connector or you can use a heavy gauge wire at the mounting tab to connect to the best ground source. Heavy gauge wire included.

All..... #13681 \$19.95/kit



GROUND BOX

This ground box allows you to centralize your grounding points for a cleaner more efficient wiring system and helps prevent grounding issues.

All..... #13584..... \$23.95/ea.

RADIO GROUND STRAPS

This kit contains three ground straps that were originally used with original AM radios, one for under the dash, one for under the hood from the firewall to the engine and one for under the car from the transmission to the floor pan inspection plate. Use for V8 or 6-cyl applications.

1955-57 #931 \$21.95/set



ENGINE GROUND STRAP

The engine ground strap installs between the lower starter mount and firewall / body.

1955-56 #12701 \$9.95/ea.



ATO REPLACEMENT FUSE PANELS

These fuse panel kits are designed to be more effective than the originals, and come complete and ready to install. Easy to follow instructions help you install a more comprehensive fuse solution. These panels will add fusing to heater, radio, back-up lights, dash lights, courtesy lights, dome lights, brake lights and clock. Also there are two ignition triggered relays that can be used for high-amp draw items.

- 1955 #12365..... \$124.95/ea.
- 1956-57 #12366..... \$124.95/ea.



AUXILIARY FUSE BLOCK BUSS ASSEMBLY

6 fuse with lead wire, side feed ring terminals and cover. Block measures 1-3/8" x 4-7/8" and carries a rating of 30-amperes maximum per circuit, 80-amp maximum per entire assembly.

- All..... #12352..... \$39.95/ea.

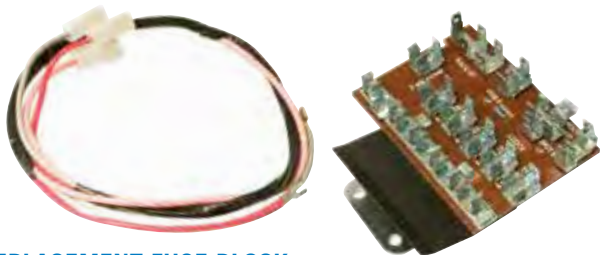

REPLACEMENT FUSE BLOCK

Correct for 1955, good replacement for 1956 and can be used on the 1957 but wiring will need to be modified.

- 1955-57 #1347..... \$44.95/ea.

GLASS FUSES

Universal AGA fast-acting 1/4" x 5/8" fuses come in blister packs.



- All 3-Amp, 5-Pack #19453..... \$3.95/ea.
- All 7.5-Amp, 5-Pack #19454..... \$1.95/ea.
- All 10-Amp, 5-Pack #19455..... \$1.95/ea.
- All 15-Amp, 5-Pack #19456..... \$1.95/ea.
- All 20-Amp, 5-Pack #19457..... \$1.95/ea.
- All 25-Amp, 5-Pack #19458..... \$1.95/ea.
- All 30-Amp, 5-Pack #19459..... \$1.95/ea.
- All Assorted, 60-Pack w/ Tester.... #19460..... \$24.95/ea.
- All SFE9, 5-pk #19485..... \$1.95/ea.
- All SFE 7.5 amp, 5-pk #19486..... \$1.95/ea.
- All AGW 4 amp, 5-pk..... #19487..... \$2.95/ea.

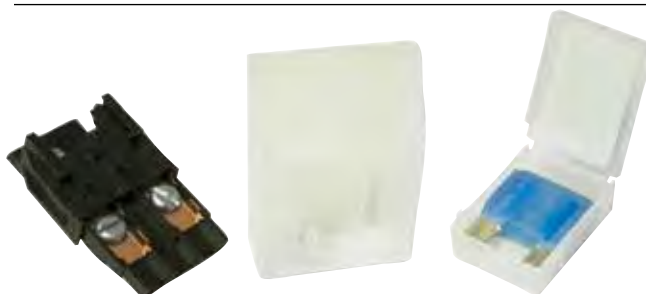

MAXI-FUSE HOLDER

Protect any circuit with the latest in in-line fuses. The Maxi-fuse holder comes with a nylon plastic holder with cover and a 60-amp fuse is perfect for those power hungry accessories.

- All 60-Amp #13673..... \$21.95/ea.



MEGA-FUSE HOLDER

- All 175-Amp #13675..... \$21.95/ea.



IN-LINE FUSE HOLDER

The waterproof fuse holder has an integral mounting tab and comes complete with terminals and a 30-amp fuse.

- All Waterproof #13676..... \$9.95/ea.



#1205/1206

#17257

GENERATOR MOUNTING BRACKETS

The 6" bracket was used on all cars without power steering. The 7" bracket was used on '55's with factory power steering. The 6-1/2" bracket was used on '56-'57's with factory power steering.

- 1955-57 6" #1205 \$22.95/ea.
- 1956-57 6-1/2" w/ Power Steering #17257 \$24.95/ea.
- 1955 7" w/ Power Steering #1206 \$27.95/ea.



GENERATOR REBUILD KITS

Whether you do it yourself or send it out, these kits have all the parts needed to rebuild the generator. Part #1843 includes two terminal posts, two brushes, one oiler assembly, one bearing, one bushing, two oil caps nuts and washers. Part #2103 includes two terminal posts, two brushes, two bearings, two oil caps, screws, nuts and washers.

- 1955-65 exc. Power Steering (Shown) #1843 \$54.95/kit
- 1955-65 w/ Power Steering #2103 \$60.95/kit



GENERATOR ADJUSTMENT BRACKET

After many years and much adjusting it may be time to replace that nicked, bent, or broken generator bracket.

- 1955-57 V8 #1299 \$39.95/ea.



OE STYLE VOLTAGE REGULATOR

For use with generators only.

- 1955-57 #130 \$82.95/ea.



1955 GENERATOR MOUNTING KIT

- 1955 2nd Style V8..... #13533..... \$12.95/kit

STARTER, GENERATOR AND DISTRIBUTOR TAG FASTENER SET

With this kit you can drill out those old fasteners, confident that you have the hardware needed to reattach the tags to the components correctly.



- 1955-62 #2202 \$1.95/set



GENERATOR MOUNTING HARDWARE KIT

For use on generators with mount bushings in end brackets.

- 1956-57 #13565 \$4.95/kit

GENERATOR MOUNT BUSHING SLEEVE

This sleeve goes into the rubber bushing on the generator end plates, Check your generator to verify if you need one or two sleeves.



- 1956-61 #15535 \$2.25/ea.

STARTERS

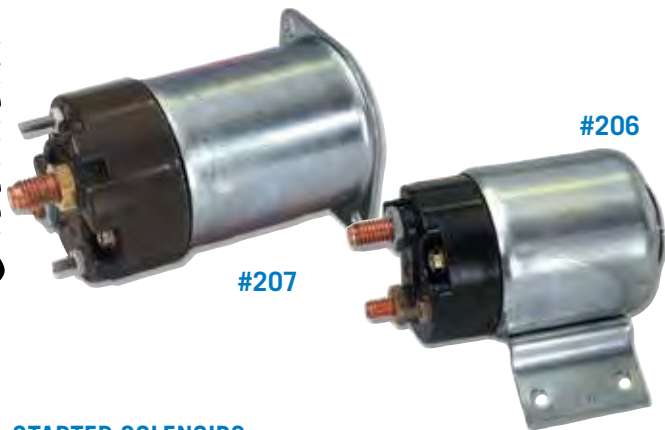

STARTER SOLENOIDS

These replacement starter solenoids install and function like the originals.

- 1955-56 #206 \$92.95/ea.
- 1957 #207 \$38.95/ea.



STARTER REBUILD KITS

- 1955-56 V8 & 6-Cyl. #13534 \$54.95/kit
- 1957-72 V8 & 6-Cyl. #13535 \$54.95/kit



THERMO-TEC STARTER HEAT SHIELD

Eliminate starter problems caused by excessive heat with this easy to install starter heat shield kit. Kit includes heat shield and straps.

- All 7" x 22" #13071 \$29.95/ea.



POWERMASTER SOLENOID "R" TERMINAL DIODE KIT

For use with Powermaster starters only.

- All #13259 \$26.95/kit

V8 STARTER MOUNTING KITS

All the fasteners you need to mount your starter. The #15437 kit contains four bolts and the #15438 contains three bolts, both kits include one stud, five lock washers and two nuts.



- 1955-56 V8 #15437 \$3.95/kit
- 1957 (Shown) #15438 \$3.95/kit

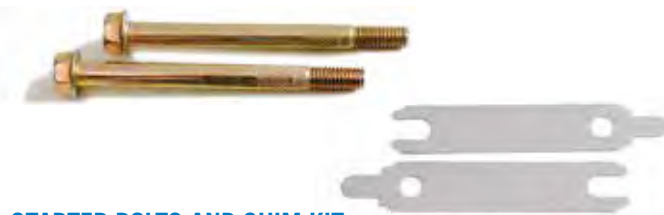

STARTER BOLTS AND SHIM KIT
All Inline Shims, Natural Finish

- #13243 \$13.95/set



STARTER BRACKET

This bracket bolts to the starter and the side of the block on all V8 applications.

- 1955-57 #1162 \$10.95/ea.



STARTER BRUSH SET

- 1955-57 #121 \$5.50/set



POWERMASTER XS TORQUE STARTERS

All V8, LT-1 and ZZ-4, 153 Tooth Flywheel, 200 ft. lbs., for 18:1 Compression..... #13241..... \$224.95/ea.
 All V8 LS Engine #13242..... \$249.95/ea.
 All V8 w/ Inline Bolt Pattern, 200 ft. lbs., for 18:1 Compression, 168 Tooth Flywheel #13293..... \$228.95/ea.

POWERMASTER MINI-STARTERS

These high torque mini starters feature dual bolt patterns and come with mounting bolts and shims. Not intended to replace 1955-56 original starters. Fits both small block and big block V8's.
 All 160 ft. lbs. #12892..... \$187.95/ea.
 All 160 ft. lbs. Chrome #12893..... \$279.95/ea.

POWERMAX STARTERS

Powermaster offers several different starters with different torque ratings. Each starter comes with a Dyno Sheet showing speed, power, and torque which is the true measure of power for a starter.



All 160 ft/lbs. 153/168 Tooth Flywheel, Inline Bolt Pattern #14043..... \$134.95/ea.
 All 160 ft/lbs. 168 Tooth Flywheel, Staggered Bolt Pattern #14044..... \$175.95/ea.



POWERMASTER MASTER TORQUE STARTERS

Master Torque V8 with inline bolt pattern, 180 ft. lbs., for 12:1 compression.
 All 153/168 Tooth Flywheel..... #13239..... \$205.95/ea.
 All 168 Tooth Flywheel..... #13240..... \$219.95/ea.

3-BOLT BELL HOUSING MOUNT STARTER

This Powermaster starter is just the ticket if you are having problems finding a decent replacement for your tired original. It looks original, but this bell housing mount starter has been beefed up with all the latest technology making it better than original. 168 tooth flywheel required.
 1955-57 #18499..... \$155.95/ea.



STARTER SOLENOID BOOT

Engine heat and day to day wear require periodic inspection and replacement of this rubber part.
 1955-56 #1406..... \$5.95/ea.



ARP STARTER BOLT KITS

All Long & Short Bolts #18230..... \$21.95/kit
 All Medium Bolts #18231..... \$22.95/kit
 All Long Bolts #18232..... \$24.95/kit
 All Gen III/IV LS Engines..... #18233..... \$20.95/kit

DELCO-REMY DETAIL TAGS

You can rebuild your starter, distributor or generator, but until you've replaced those tarnished old tags, the job isn't finished. Rivets included.
 1955-57 #994..... \$12.95/set

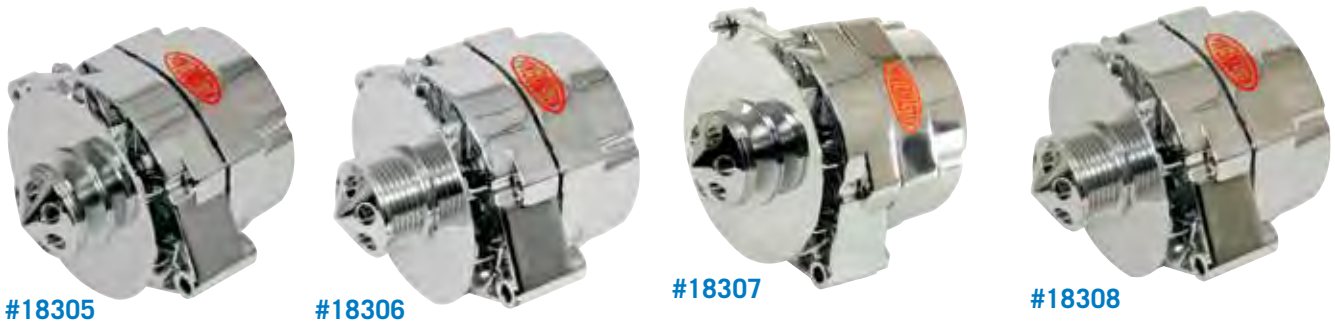

ALTERNATORS WITH BAFFLES AND CONES

Upgrading your charging system is a must in modern builds these days with all the additional electronics being put into cars. Alternators from Powermaster are just what you need to fill your charging needs. These alternators feature fan cones baffles for better cooling and looks. For the ultimate in good looks check out the Smoothie Series that feature a smoothed housing, hidden case bolts and are beautifully chrome plated. 150-amp models are recommended for cars with electric fans.

All 100-Amp, V-Belt, Chrome	#18305.....	\$169.95/ea.
All 100-Amp, 6-Groove, Chrome	#18306.....	\$175.95/ea.
All 150-Amp, V-Belt, Chrome	#18307.....	\$229.95/ea.
All 150-Amp, 6-Groove, Chrome	#18308.....	\$239.95/ea.
All 150-Amp, V-Belt, Smooth, Chrome	#18309.....	\$249.95/ea.
All 150-Amp, 6-Groove, Smooth, Chrome	#18310.....	\$259.95/ea.
All 100-Amp, V-Belt, Smooth, Chrome	#18311.....	\$195.95/ea.
All 100-Amp, 6-Groove, Smooth, Chrome	#18312.....	\$195.95/ea.
All 150-Amp, 1-V-Belt Pulley, Smooth, Polished	#14049.....	\$249.95/ea.
All 100-Amp, 2-V-Belt Pulley, Smooth, Polished	#14050.....	\$195.95/ea.
All 150-Amp, 6-Groove Pulley, Smooth, Polished.....	#14051.....	\$195.95/ea.



POWER STEERING STYLE ALTERNATORS

These replacement 85-amp alternators look just like your generator but they give you the power you need to run all those late model electrical upgrades. Your original power steering pump attaches just like it did on your generator and once installed it looks completely original. Available with or without provisions for running your original generator light.

1955-59 85-Amp, w/ GEN Light	#18666.....	\$549.95/ea.
1955-59 85-Amp, w/o GEN Light	#18667.....	\$549.95/ea.



POWERMASTER POWERGEN ALTERNATORS WITH LAMP TERMINALS

With more power and the addition of a trouble light terminal, the PowerGen is a great way to add modern charging power with vintage looks. Verify which size you need before ordering. Short versions have a 6-inch field housing and long versions have a 7.1-inch field housing. Long versions use 7-inch bracket, and short versions use 6-inch bracket.

1955-57 90-Amp, Short, Black..... #16898..... \$429.95/ea.
 1955-57 90-Amp, Short, Chrome.. #16899..... \$569.95/ea.
 1955-57 90-Amp, Long, Black #16900..... \$429.95/ea.
 1955-57 90-Amp, Long, Chrome... #16901..... \$569.95/ea.



POWERMASTER POWERGEN ALTERNATORS

Retro meets techno, generator looks with alternator reliability. PowerGen's feature 90-amps output (60 at idle) and utilize one wire hookup and are designed to use the original generator brackets. Long versions use 7-inch bracket, and short versions use 6-inch bracket.

1955-57 90 Amp, Short, Black..... #14045..... \$439.95/ea.
 1955-57 90-Amp, Long, Black #13248..... \$439.95/ea.
 1955-57 90-Amp, Long, Polished . #13249..... \$469.95/ea.
 1955-57 90-Amp, Short, Polished #14046..... \$469.95/ea.
 1955-57 90-Amp, Short, Chrome.. #14047..... \$549.95/ea.
 1955-57 90-Amp, Long, Chrome... #14048..... \$549.95/ea.



POWERMASTER ALTERNATORS

Powermaster alternators are internally regulated and can be set up for either one or three wire operation. Each alternator comes with a "Proof of Performance" assuring you that your alternator has been fully tested and quality assured. V8 alternator brackets can be found on pages 506-507.

All 100-Amp, Chrome..... #12890..... \$149.95/ea.
 All 150-Amp, Chrome #12891..... \$189.95/ea.
 All 100-Amp, Natural #13245..... \$129.95/ea.



6-CYLINDER ALTERNATOR CONVERSION BRACKET KIT

For the original 235 C.I. 6-Cyl when converting to an alternator.

1955-57 #14224..... \$63.95/kit



Photo courtesy of GERTMAN2000



BILLET SPECIALITIES

ONE-PIECE ALTERNATOR PULLEY WITH FAN

All Polished..... #17046..... \$67.95/ea.



BILLET ALTERNATOR PULLEY

All Single Groove, Polished #12463..... \$37.95/ea.



ALTERNATOR PLUGS

All CS130, w/ Lead Wire #17507..... \$27.95/ea.

All CS130D, w/ Lead Wire #17508..... \$31.95/ea.



ALTERNATOR CHARGE WIRE

Recommended for high output alternators.

All 6-Gauge, 84" #13247..... \$42.95/ea.



#17506

ALTERNATOR CONVERSION PLUGS

All SI to CS Series Alternators #17505..... \$22.95/ea.

All SI to CS130D Series Alternators

..... #17506..... \$29.95/ea.



ALTERNATOR BATTERY TERMINAL BOOT

All..... #13246..... \$6.95/ea.

Thanks for posting to Facebook!





PAINLESS PERFORMANCE WIRE HARNESS KITS

The Painless 21 and 28-circuit harness is designed to custom fit your Shoebox Chevy with a factory location fuse panel, special dash and turn signal connectors. These harnesses feature color coded wires fully labeled with each circuit the entire length of the wire. Some additional parts will be required.

- 1955-57 28-Circuit #14622..... \$539.95/kit
- 1955-57 21-Circuit #14623..... \$499.95/kit

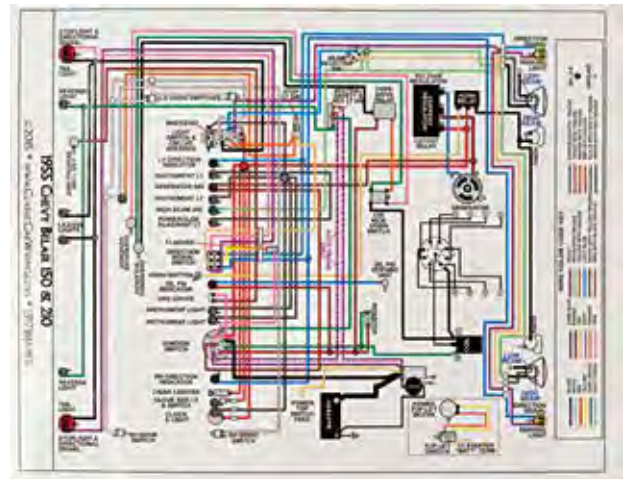
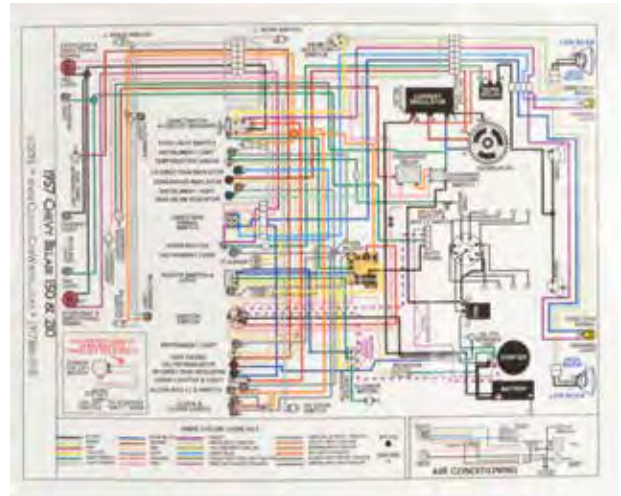

LAMINATED COLOR WIRING DIAGRAMS

Tired of those hard to read almost impossible to decipher black and white wiring diagrams copied out of 60 year old shop and repair manuals? Danchuk has the solution!

- All wire colors (including tracers) and component information is from the original factory service manuals. This means the wire colors on the diagram are the same as what was originally in your car.
- Diagram covers the complete basic car including: interior and exterior lights, engine and engine compartment, firewall, under dash, instrumentation, etc.
- All text is crystal clear and easy to read, and all colors are easy to distinguish.
- Diagrams are laminated in heavy plastic for durability and ease of use. (no more grease smudged expensive shop manuals!). Field tested and mother approved with coffee, beer, soda, all kinds of grease, dirt and paint. Sorry, battery acid likes them just as much as battery trays.

- 1955..... #18366..... \$17.95/ea.
- 1956..... #18367..... \$17.95/ea.
- 1957..... #18368..... \$17.95/ea.



PAINLESS PERFORMANCE HALOGEN HEADLIGHT HARNESS

They are made with TXL high temp wire, weather resistant 30-amp fuse, and two 40-amp weather resistant relays capable of handling up to 150 watts. Part #14610 is for use with a H-9004 and H-9007 bulbs .

All..... #14610..... \$109.95/ea.



PAINLESS PERFORMANCE CLASSIC BRAID WIRE WRAPS

The newest wire wrap by Painless Performance is "Classic Braid". Classic Braid is a tighter weave than power braid which looks very original in your classic car. It is woven from high tech materials and features a lateral split for ease of installation. Classic Braid resists cuts and abrasions and it retains it's shape up to 250 degrees. The Classic Braid chassis kit contains: 6-feet of 1-inch diameter, 10-feet of 3/4-inch diameter, 30-feet of 1/2-inch diameter, 60-feet of 1/4-inch diameter and 15-feet of 1/8-inch diameter classic braid wire wrap along with heat shrink, tie wraps and tape.

All.....	#17031	\$169.95/kit
All 1/2", 10-ft.....	#17028	\$31.95/ea.
All 3/4", 6-ft.....	#17029	\$28.95/ea.
All 1", 12-ft.....	#17030	\$45.95/ea.



PAINLESS PERFORMANCE FUEL INJECTION WIRE HARNESSSES

Those who choose to run the factory ECM will appreciate the simplicity of a Painless fuel injection wire harness. You can try to make the stock harness work, but why complicate things? Painless has worked out all the potential problems, so all you have to do is follow the instructions and you're on your way. Every wire is labeled for ease of installation.

2003-06 4.8-6.0L.....	#17419	\$699.95/kit
1997-04 LS1, LS6.....	#17420	\$599.95/kit
2006-08 LS-2,3,7, W-4L60E/65E.....	#17421	\$699.95/kit
2007-Up Gen IV W-4L65-85E Transmission.....	#17422	\$749.95/kit



PAINLESS PERFORMANCE POWER BRAID WIRE WRAPS

Power Braid protects and cleans up any harness installation with ease. Power Braids laterally split design closes around wire bundles without the need for additional taping or fasteners.

All 1/4", 20-ft.....	#14618	\$29.95/ea.
All 1/2", 10-ft.....	#14619	\$29.95/ea.
All 3/4", 6-ft.....	#14620	\$29.95/ea.
All 1-1/2", 4-ft.....	#14621	\$39.95/ea.
All 1/8", 20-ft.....	#18361	\$33.95/ea.
All 1/4", 20-ft Classic Braid.....	#18362	\$34.95/ea.

OVERDRIVE WIRE HARNESS SWITCH PLUG

This new overdrive connector plug holds the 4 wires that plug onto the kick down switch on the carburetor.



1955-68.....	#18935	\$21.95/ea.
--------------	--------	-------------



1957 GRILLE BAR WIRING CONNECTOR AND GROMMET SET 1957.....

#18274.....	\$17.95/set
-------------	-------------

INNER FENDER TERMINAL BLOCK CLIPS

These clips hold the wire harness plastic connectors in place on each side of the radiator. Due to variances on some reproduction wire harnesses, some fitting may be required on the plastic connector.



1955-56.....	#17012	\$9.95/pr.
--------------	--------	------------



CLASSIC UPDATE COMPLETE WIRE HARNESSSES

If you are wanting to update the wiring in your 5-6-7 the Classic Update Series harness kit is the way to go. These kits have given the builder complete flexibility to use original stock switches and components as well as custom updated accessories, such as Dakota Digital, Vintage Air, and Ididit Steering Columns. Each kit comes with all the switches and sockets needed. If installing in a convertible be sure to order the convertible top harness #15064. Ignition key and tumbler not included, part #17800 on page 263.

1955-56	#11203	\$611.95/kit
1957	#11204	\$611.95/kit
1955-57 Convertible Top Harness	#15064	\$34.95/ea.



WEATHER PROOF HALOGEN HEADLIGHT HARNESS

This headlight harness gets you the maximum power from your headlights, and is recommended for any H4 or 9000 series headlight upgrade. Draws power directly from battery, through the relay.

All OE, H4..... #14609..... \$160.95/ea.



FAN-THOM II ELECTRIC FAN CONTROL KITS

Fan-Thom fan controls offer you clean, simple and safe fan controller for electric fans. The supplied thermostat threads into the engine or cooling system for a professional installation.

All 200°..... #14615.....\$58.95/kit
 Note: Turns fan on at 200° & off at 185°.
All 185°..... #14616.....\$53.95/kit
 Note: Turns fan on at 185° & off at 170°.

WIRING CONNECTORS FOR ELECTRIC GAUGES

Auto Meter gauge wire connectors allow you to construct your own custom gauge harnesses. They're designed for use with Auto Meter short-sweep electrical gauges—and include terminal connectors and the necessary crimp terminals for use on short-sweep electric air-core gauges.



All 3-Terminal, Short Sweep..... #18091..... \$17.95/ea.
All 8-Terminal, Tach/Speedo..... #18092..... \$17.95/ea.



WEATHERPROOF FUEL PUMP RELAY KIT

All..... #14614..... \$59.95/ea.



#12807

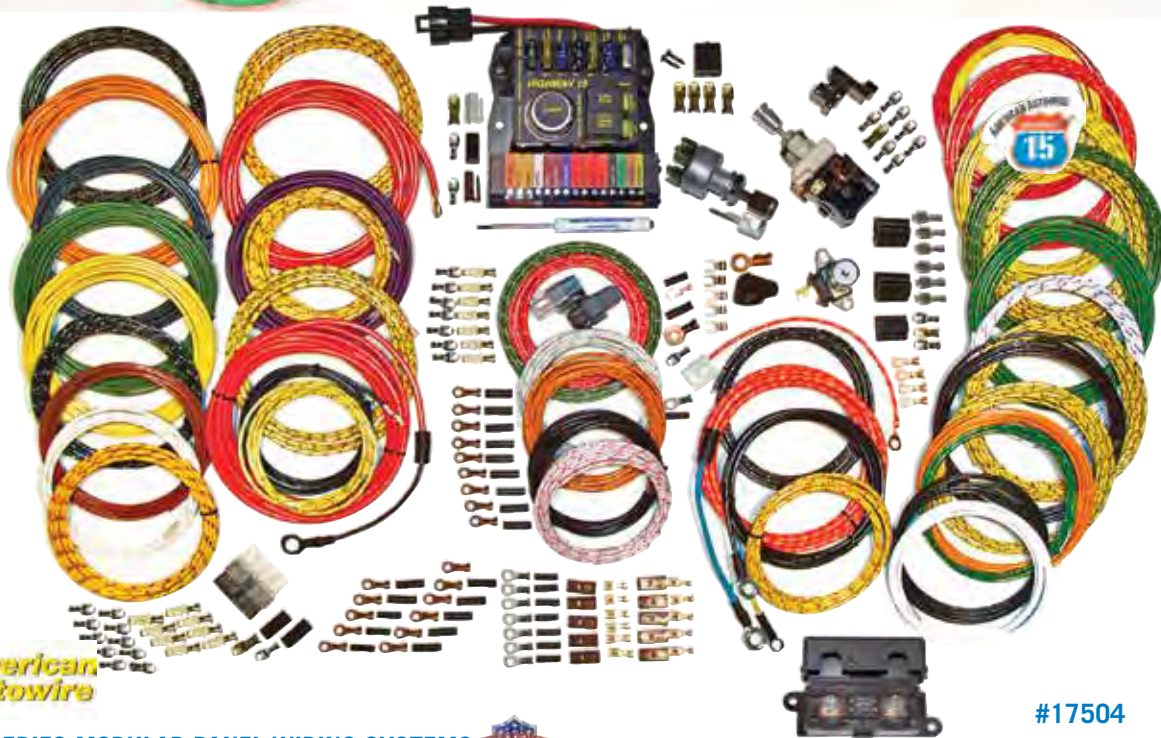

#17504



HIGHWAY SERIES MODULAR PANEL WIRING SYSTEMS

American Autowire Highway series are available in either 15 circuit or 22 circuit systems. The modular design is over engineered for street rods and custom applications. Kits feature large easy to read circuit printing on every GM color coded wire. Wiring harness kits come with headlight, ignition and dimmer switches, and can be configured for GM column mounted ignitions. Also included is a full color schematic and step-by-step instructions for trouble free installation. For a traditional 1950's look of braided and lacquer wire, be sure to order the Highway 15 Nostalgia wiring system, shown above.

All 15-Circuit, Highway 15	#12807.....	\$418.95/kit
All 15-Circuit, Highway 15 Nostalgia	#17504.....	\$1259.95/kit
All 22-Circuit, Highway 22	#12808.....	\$488.95/kit



Electrical

FACTORY FIT WIRING HARNESSSES



We are proud to offer FACTORY-FIT wire harnesses. These quality USA made wire harnesses are manufactured to original GM specifications using original GM components. Where original parts are not available, new parts have been fabricated to original specifications. With safety and longevity being an issue, the original design concepts have been improved upon to provide the highest quality harnesses available. Just as DanChuk does, FACTORY-FIT takes pride in their workmanship and places the utmost emphasis on the manufacturing of quality products. **Made in the USA.**



WIRING HARNESSSES

1955-57 Lighter Fuse	#1199	\$10.95/ea.	1956 V8 Overdrive.....	#440	\$95.95/ea.
1955 6-Cyl. Standard Starter-Ignition	#437	\$69.95/ea.	1956 6-Cyl. Overdrive.....	#1584	\$93.95/ea.
1955 6-Cyl. Automatic Starter-Ignition.....	#427	\$79.95/ea.	1956 4-Door Sedan Taillight	#448	\$169.95/ea.
1955 V8 Standard Starter-Ignition	#423	\$69.95/ea.	1956 4-Door Hardtop Taillight	#448A	\$149.95/ea.
1955 V8 Automatic Starter-Ignition.....	#404	\$69.95/ea.	1956 2-Door Hardtop & Sedan Taillight	#433	\$139.95/pr.
1955 Heater &/or A/C Control Panel Light	#1573	\$8.95/ea.	1956-57 4-Door Wagon Fuel Tank Ext. Wire.....	#1572	\$8.95/ea.
1955 Fuse Panel to Heater Switch.....	#1574	\$8.95/ea.	1957 2-Door Wagon Taillight	#453B	\$169.95/ea.
1955 Fuse Panel to Heater Blower Switch.....	#1575	\$8.95/ea.	1957 4-Door Wagon Taillight	#456B	\$124.95/ea.
1955 Fuse Panel	#426	\$18.95/ea.	1957 Nomad Taillight	#450B	\$169.95/ea.
1955 Under Dash w/ Internal Alternator			1957 Grille Bar.....	#424	\$39.95/ea.
(Includes Headlight Generator)	#2765	\$204.95/ea.	1957 Headlight Socket	#443	\$18.95/pr.
1955 Under Dash (Includes Headlight Generator)	#415	\$194.95/ea.	1957 Headlight Socket	#19381	\$36.95/pr.
1955 Clock Socket & Pigtails	#431	\$19.95/ea.	1957 Back-Up Lights	#406	\$24.95/ea.
1955 Heater Fan Motor	#418	\$8.95/ea.	1957 Courtesy Lamp, Underdash	#459A	\$38.95/ea.
1955 Alternator Conversion w/ External Regulator ...	#408	\$59.95/ea.	1957 Overdrive.....	#436	\$93.95/ea.
1955 Starter-Ign. V8 Auto w/H.E.I. Distributor.....	#12359	\$79.95/ea.	1957 Heater Fan Motor	#425	\$8.95/ea.
1955 Starter-Ign. V8 Standard w/H.E.I. Distributor ...	#12360	\$69.95/ea.	1957 6-Cyl. Headlight Generator	#441	\$104.95/ea.
1955 V8 Overdrive.....	#434	\$93.95/ea.	1957 V8 Headlight Generator	#441A	\$94.95/ea.
1955 6-Cyl. Overdrive.....	#1583	\$93.95/ea.	1957 Alternator Conversion w/ Ext. Regulator.....	#411	\$59.95/ea.
1955 2-Door Sedan Taillight	#442	\$139.95/ea.	1957 Alternator Conversion w/ Int. Regulator	#410	\$54.95/ea.
1955 4-Door Sedan Taillight	#447	\$149.95/ea.	1957 Starter-Ign. V8 Auto w/H.E.I. Distributor.....	#12363	\$69.95/ea.
1955 2-Door Hardtop Taillight.....	#419	\$139.95/ea.	1957 Starter-Ign. V8 Standard w/H.E.I. Distributor ...	#12364	\$79.95/ea.
1955-56 Parklight.....	#420	\$34.95/pr.	1955-57 Trunk Light Assembly	#12367	\$34.95/ea.
1955-57 Parklight for Press-In Socket.....	#420A	\$59.95/pr.	1957 V8 Dual 4BC Standard Starter-Ignition.....	#1588	\$79.95/ea.
1955-56 Headlight	#402	\$39.95/pr.	1957 V8 Dual 4BC Automatic Starter-Ignition.....	#1586	\$79.95/ea.
1955 4-Door Wagon Taillight	#456	\$169.95/ea.	1957 V8 F.I. Standard Starter-Ignition	#1589	\$79.95/ea.
1955 2-Door Wagon Taillight	#453	\$159.95/ea.	1957 V8 F.I. Automatic Starter-Ignition	#1587	\$84.95/ea.
1955 Nomad Taillight	#450	\$169.95/ea.	1957 6-Cyl. Standard Starter-Ignition	#438	\$69.95/ea.
1955 Convertible Taillight.....	#444	\$189.95/ea.	1957 6-Cyl. Automatic Starter-Ignition.....	#416	\$79.95/ea.
1956 2-Door Wagon Taillight	#453A	\$169.95/ea.	1957 V8 Standard Starter-Ignition	#422	\$69.95/ea.
1956 4-Door Wagon Taillight	#456A	\$169.95/ea.	1957 V8 Automatic Starter-Ignition.....	#405	\$69.95/ea.
1956 Nomad Taillight	#450A	\$169.95/ea.	1957 Heater Control Panel Light.....	#1577	\$8.95/ea.
1956 Convertible Taillight.....	#444A	\$189.95/ea.	1957 Under Dash.....	#414	\$189.95/ea.
1955-56 Back Up Lights w/ Conversion Plates	#401	\$39.95/pr.	1957 Clock Socket & Pigtails	#430	\$19.95 /ea.
1955-56 Courtesy Lamp, Underdash	#459	\$38.95/ea.	1957 6-Cyl. Overdrive.....	#1585	\$93.95/ea.
1955-56 Alternator Conversion w/ Int. Regulator	#403	\$54.95/ea.	1957 6-Cyl. Conv. Solenoid-to-Pwr Top Connector		
1955-56 6-Cyl. Solenoid-to-Pwr Top Conn.	#1578	\$11.95/ea.	#1580	\$13.95/ea.
1955-56 V8 Solenoid-to-Pwr Top Connector	#1579	\$11.95/ea.	1957 V8 Conv Solenoid-to-Pwr Top Connector	#1581	\$11.95/ea.
1955-56 Taillight Harness Pigtails	#12246	\$38.95/ea.	1957 Convertible Taillight.....	#446	\$179.95/ea.
1955-56 Taillight Harness Pigtail Grommets	#12244	\$27.95/ea.	1957 4-Door Hardtop Taillight	#449	\$169.95/ea.
1955-57 Dakota Digital Gauge Wiring Kit.....	#12368	\$49.95/kit	1957 4-Door Sedan Taillight	#449A	\$169.95/ea.
1956 6-Cyl. Standard Starter-Ignition	#439	\$69.95/ea.	1957 2-Door Hardtop Taillight	#413	\$139.95/ea.
1956 6-Cyl. Automatic Starter-Ignition.....	#428	\$84.95/ea.	1957 2-Door Sedan Taillight	#413A	\$139.95/ea.
1956 V8 Standard Starter-Ignition	#421	\$69.95/ea.	1957 Taillight Harness Pigtails	#12247	\$38.95/pr.
1956 V8 Automatic Starter-Ignition.....	#407	\$69.95/ea.	1957 Taillight Harness Pigtail Grommets	#12245	\$27.95/pr.
1956 Under Dash.....	#429	\$189.95/ea.	1957 Headlight Gen. Harness w/ Internal Alt.	#2767	\$114.95/ea.
1956 Clock Socket & Pigtails	#432	\$19.95/ea.	1955-56 6-Cyl. Solenoid Rear Body Power Top Connector Lead		
1956 Automatic Column Shift Indicator Light.....	#1576	\$8.95/ea.	#13864	\$9.95/ea.
1956 Headlight Generator	#417	\$94.95/ea.	1955-56 Solenoid To Power Access. Circuit Breaker, 6-Cyl.		
1956 Headlight Gen. Harness w/ Int. Altern.....	#2766	\$114.95/ea.	#13866	\$9.95/ea.
1956 Alternator Conversion w/ Ext. Regulator.....	#412	\$59.95/ea.	1955-56 Solenoid to Power Access. Circuit Breaker, V8		
1956 Starter-Ign. V8 Auto w/H.E.I. Distributor.....	#12361	\$79.95/ea.	#13867	\$12.95/ea.
1956 Starter-Ign. V8 Standard w/H.E.I. Distributor ...	#12362	\$79.95/ea.	1957 Solenoid to Rear Body Connector, 6-Cyl.	#13868	\$11.95/ea.

 WARNING! Products on these pages may contain chemicals known to the State Of California to cause cancer and/or birth defects or reproductive harm. www.p65warnings.ca.gov

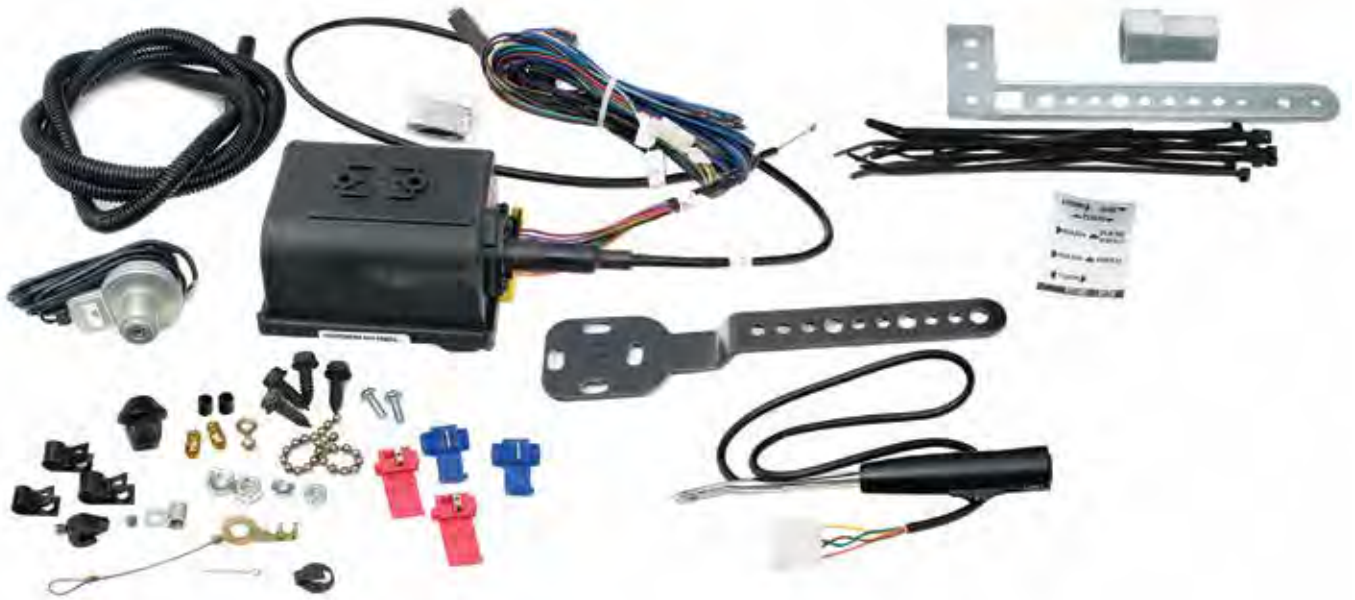

CRUISE CONTROL KITS

Whether you have a cable driven speedo or updated to a new electronic speedo you can add the convenience of cruise control to your classic Chevy. Kits come with everything to install including a controller that replaces the turn signal arm on factory original, Ididit and Flaming River Columns.

- All for Cable Driven Speedometers..... #15124..... \$299.95/kit**
- All for Electronic Speedometers..... #15125..... \$268.95/kit**



STAINLESS CRUISE CONTROL CABLES

An excellent upgrade to our cruise control kits #15124-25.

- All Cut to Fit #15143..... \$105.95/ea.**
- All Tune Port Engines #15144..... \$105.95/ea.**



DASH MOUNTED CRUISE CONTROL SWITCH

For those who prefer to mount their cruise control controller on the dash or anywhere else.

- All..... #15126..... \$61.95/ea.**



Photo courtesy of GERTMAN2000



CRUISE CONTROL HANDLE COVERS

Dress up your column mounted controller with one of these handle covers. Fits cruise control kits, #15124 or #15125 above.

- All Polished Aluminum #15127..... \$46.95/ea.**
- All Brushed Aluminum #15128..... \$46.95/ea.**



IDIDIT TOUCH-N-GO KEYLESS IGNITION SYSTEM

Get the most advanced keyless ignition technology at the tip of your finger, with the Touch-N-Go Start keyless ignition system from Ididit. This is the industries FIRST touch sensitive start system and features a 22mm aluminum button with multi-color LED lights that always let you know what mode it's in. There are no moving components to wear out, ensuring years of outstanding performance. You'll never have to use your keys again! Just stick your programmable key fob in your pocket or wallet and the system will sense your approach, having the capability of automatically unlocking your door as you get close and locks as you leave (the system only responds when the key fob is in range). For added safety, this system can also be programed to turn on your dome lights as you approach.

All..... #17032..... \$749.95/kit



AUTO METER GPS SPEEDOMETER INTERFACE MODULE

This Auto Meter universal GPS interface module turns any electronic speedo into a GPS speedo with the push of a button. The units are plug and play for all Auto Meter speedos and they will also work with virtually any electronic speedo on the market with an on-button 10 second calibration. The paintable magnetic micro antenna is fully sealed to keep out water and dust. 10 Hz sampling rate.

All..... #17014..... \$249.95/ea.



CLASSIC INSTRUMENTS GPS SKYDRIVE ANTENNA, SPEEDOMETER SENDER

Calibrate your Classic Instruments speedometer in less than a minute and you don't even have to leave your driveway! Sky Drive is the world's most accurate electronic speedometer sending unit. No need for ECU convertors or pulse signal generators screwed onto your transmission. The new Sky Drive uses GPS Satellite signals to operate your electronic speedometer. It updates 10 times per second and with one push of a button it's ready to go. SkyDrive! The World's Most Accurate Speedo Sender.

All..... #16989..... \$299.95/ea.

DAKOTA DIGITAL SPEEDOMETER GPS INTERFACE

The Dakota Digital speedometer GPS interface modules are specifically made for the custom automotive market. Their highly advanced electronic and software design allows them to work unlike anything else, with accelerometers and predictive software to compensate for the times when GPS inherently struggles: overpasses, mountains, tunnels, heavy tree cover, large buildings, passing large vehicles, etc. Their unique electronic architecture provides for negligible current usage when off, and yet they offer lightning fast start-up and signal acquisition. Updating the speed information 10 times per second provides tremendous accuracy, while their integrated omnidirectional antenna provides for installation flexibility and simplicity. The Dakota Digital speedometer GPS interface modules do such a tremendous job of rendering the correct speed information, they can be used to feed an aftermarket cruise control system. They can be used in conjunction with a Dakota Digital VFD3 or VHX instrument system and the modules are also fully compatible with other electronic speedometers on the market.



Updating the speed information 10 times per second provides tremendous accuracy, while their integrated omnidirectional antenna provides for installation flexibility and simplicity. The Dakota Digital speedometer GPS interface modules do such a tremendous job of rendering the correct speed information, they can be used to feed an aftermarket cruise control system. They can be used in conjunction with a Dakota Digital VFD3 or VHX instrument system and the modules are also fully compatible with other electronic speedometers on the market.

All..... #18675..... \$199.95/ea.



#14265



#14266

**PUSH BUTTON AM/FM RADIOS
- NOW WITH BLUETOOTH 3.0**

These reproduction radios are the closest things to the originals in appearance, but they have many of the updated features you need for a better sound system. All radios fit just like the originals and use factory style antenna. Now with built-in Bluetooth 3.0 that lets you make calls and stream music handsfree. All radios feature: AM/FM digital tuner, AM dial is in foreground FM is in background, 10 Presets (5AM, 5FM), 4 x 45 watts RMS out, CD or satellite radio inputs, correct knobs and pushbuttons. Knobs control: volume, bass, treble, balance, fader and tuning.

1955 180 Watts #14265..... \$632.95/ea.
1956 180 Watts #14266..... \$632.95/ea.



RADIO KNOBS

Works with stock radios only.

- 1955..... #11255..... \$11.95/ea.
- 1956..... #11256..... \$10.95/ea.
- 1957..... #887..... \$39.95/set

**RADIO TONE
CONTROL KNOBS**

Includes one tone control knob and one dummy. Used on all standard and pushbutton radios.

- 1955-56 #989..... \$7.95/pr.



1957 RADIO TONE CONTROL KNOB

Flawless injected knobs just like the originals.

- 1957..... #990..... \$4.95/ea.



1957 RADIO PUSH BUTTONS

After years of use it's time to replace those cracked and faded pushbuttons. Set of five.

- 1957..... #946..... \$19.95/set

RADIO VIBRATOR TUBE

This solid state radio vibrator tube will replace the one in your original radio. Type 2215-N. **Made in the USA.**

- 1955-57 #859..... \$38.95/ea.



RADIO TUBE

This radio tube is designated OZ4/OZ4A. It will replace the one in your original radio. **Made in the USA.**

- 1955-57 #985..... \$13.95/ea.



RADIO SPEAKER BOOT

This boot transmits the sound from your speaker through the dashboard. Works with original speaker brace.

- 1955-56 #858 \$24.95/ea.



RADIO GROUND STRAPS

This kit contains three ground straps that were originally used with original AM radios, one for under the dash, one for under the hood from the firewall to the engine and one for under the car from the transmission to the floor pan inspection plate. Use for V8 or 6-cyl applications.

- 1955-57 #931..... \$21.95/set





#17157



#17158

AM/FM WONDERBAR RADIOS - NOW WITH BLUETOOTH 3.0

These reproduction radios are the closest things to the originals in appearance, but they have a lot of the updated features you need for a better sound system. All radios fit just like the originals and use factory style antenna, the Wonderbar duplicates the action of the original as it seeks up, then returns to the bottom and starts over. Now with built-in Bluetooth 3.0 lets you make calls and stream music handsfree. All radios feature: AM/FM digital tuner, AM dial is in foreground FM is in background, 10 Presets (5AM, 5FM), 4X45 watts RMS out, CD or satellite radio inputs (2 RCA rear jacks), correct knobs and pushbuttons. Knobs control: volume, bass, treble, balance, fader and tuning.

1955 180 Watts (Shown)	#17157	\$748.95/ea.
1956 180 Watts (Shown)	#17158	\$809.95/ea.
1957 180 Watts	#14267	\$749.95/ea.

RADIO SPEAKERS

For those original Chevrolet radios there is only one 4 ohm speaker to consider: ours. This reproduction



is accurate all the way down to the audio response specifications. It not only looks like the original, it sounds like the original, too. This speaker was designed for mono radios only; for stereos see parts #10847, #10848 and #10849.

1955-57 Standard Radio w/o Transformer	#018	\$48.95/ea.
1957, 58-62 Vette Pushbutton Radio w/ Transformer (Shown)	#017	\$55.95/ea.



STEREO SPEAKERS

All 6" x 9", 200 Watts, 3-Way..... #12170.....\$99.95/pr.

KENWOOD DUAL FRONT SPEAKER

Kenwood quality upgrade replacement for your original front in-dash speaker. This great quality speaker can handle up to 80 watts and is built and designed to fit directly in the stock location.



1955-57 #10848..... \$76.95/ea.

DUAL FRONT SPEAKER

This speaker can handle up to 50 watts and is built and designed to fit directly under the dash.



1955-57 #10849..... \$31.95/ea.

DUAL VOICE COIL SPEAKER

Get the best quality sound possible from your original dash speaker location. These speakers have up to 70% more cone area than the conventional dual speaker setup. This will give you improved bass response and power handling. Dual tweeter and both channels hook up to one speaker.

1955-57 120 Watts #10847..... \$59.95/ea.



STEREO AMPLIFIER

200 watts per channel x 2. All..... **#11180\$149.95/ea.**

SPEAKER BRACE

If your 1955-56 doesn't have the original bracket for the dash speaker this unit will enable you to install a new speaker.

1955-56 #10850.\$29.95/ea.



#10174

SPEAKERS

KICK PANEL SPEAKERS

Want more sound without cutting or drilling? These "kicks" sound great, enhance interior appearance and affords a "no modification" fit. Made of black ABS plastic and can be painted to match your interior.

- 1955-56 100 Watt..... #10172.....\$149.95/pr.
- 1957 100 Watt #10174.....\$149.95/pr.
- 1955-56 Pioneer, 120 Watt #10175.....\$199.95/pr.
- 1957 Pioneer, 120 Watt..... #10177.....\$199.95/pr.



BACKSEAT DRIVER SPEAKER ASSEMBLY O/S

1955-57 400 Watt Amp, 8" Woofers

..... #13408..... \$265.95/set



CUSTOM AUTOSOUND UNDERCOVER STEALTH SPEAKERS

Enclosure is 8-inch x 11-inch and only 2-7/8-inch high and features a 5-1/2-inch woofer and two tweeters in each enclosure.

All 120 Watts #12143.....\$139.95/pr.



#13281

#13280

KICK PANELS WITHOUT SPEAKERS

Use these kick panels with speakers 6" in diameter.

- 1955-56 #13280.....\$99.95/pr.
- 1957..... #13281.....\$99.95/pr.



UNDERCOVER 2 SPEAKERS

Want a little more from your hidden speaker system? This is it! The UNDERCOVERII with an 8-inch woofer and 2 Piezo tweeters in each box. This system can be mounted in many of the same locations as the regular UNDERCOVER. With the 8-inch woofer in UNDERCOVERII you get a much fuller deeper sound. 200 watt capacity. Sold as pair. Measure 11-inch W x 12.5-inch D x 3-inch H

All 250 Watt..... #16357.....\$165.95/pr.



REAR SPEAKER GRILLES

- 1955-57 Black..... #17601.....\$16.95/ea.
- 1955-57 Chrome #19040.....\$25.95/ea.

CHECK PAGE 186 FOR TMI CUSTOM UPHOLSTERY KICK PANEL SPEAKERS AVAILABLE VIA SPECIAL ORDER.



CUSTOM AUTOSOUND AMPLIFIED SPEAKER - SYSTEM 1

Flat active aluminum subwoofer enclosure with 8" woofer plus 2-channel amplifier. Two 3" mid-tweeter satellite speakers in die cast metal housings. Amplifier installation kit included. Amplifier power: 150 watt subwoofer / 2x50 watt mid / tweeter.

All w/ Satellite Speakers..... #17353..... \$299.95/ea.

SECRETAUDIO

CUSTOM AUTOSOUND SECRETAUDIO STEREO SYSTEMS

With Stealth Sound Technology the SST-V is equipped with bluetooth for streaming your favorite tunes as well as a hands free option for your cell phones. The SST-V is a 200 watt AM/FM radio with USB MP3/WMA flash drive, iPod control, CD control and satellite-ready via bluetooth. The SST-V features "RF" (radio frequency) remote control making it ideal for your classic. The SST-V hideaway radio is designed to provide your classic car exceptional audio quality leaving the dash and original radio visible in the dash. The SST-V receiver/ amplifier unit is usually hidden underneath the driver's seat or behind the dashboard and integrates with the vehicle's speaker system. If your speakers are for a mono radio they should be replaced with dual voice coil speakers, Danchuk parts #10847, #10848, or #10849.



1955-72 SST..... #10845..... \$359.95/set

Custom Autosound kits modify each radio to fit specific vehicles so the radio fits your dash right out of the box. No kits, bezels or modifying to get the look and fit you want for your vehicle.



CUSTOM AUTOSOUND USA-230 STEREO

This new model radio has the same cosmetics as the USA-630. If you don't need the USB/MP3 or CD changer control, then this is the model for you. Radio has no cassette but comes with auxiliary audio input. If you have a portable MP3 player or Satellite radio just plug it into the AUX input and listen to it through this radio.

Features Include:

AM/FM stereo, 200 watts (4x50), auxiliary input (RCA rear), RCA to 1/8" pin jack included, digital clock, electronic tuner, 30 pre-sets (4AM & 12FM), 4-channel RCA pre-outs, 4-way fader, power antenna lead

- 1955 Chrome, No Cassette..... #15471..... \$199.95/ea.
- 1956 Chrome, No Cassette..... #15472..... \$199.95/ea.
- 1957 Chrome, No Cassette..... #15473..... \$199.95/ea.



CUSTOM AUTOSOUND USA-4DIN STEREO

If your car's dash has been modified to fit a more modern radio, but the radio never quite looked right because it was too modern, or you want to do a custom install in the dash or console and want a CD player that looks the part, your radio is finally here. The USA-4DIN is the first in-dash CD/MP3 player that looks like it belongs in your classic and features a fold down fully detachable chrome front panel and front USB port.

Features Include:

AM/FM-CD MP3 player, 24 presets (18FM-6AM), 160 watts (4X40), 1 pair of RCA pre-outs, Separate Bass and Treble, Clock, Front Aux. input, front USB port. Fits in standard DIN radio opening (approx) 7.2" X 2.11".

- 1955-57 AM/FM, CD..... #15636..... \$184.95/ea.

IF YOU OWN A CLASSIC, OTHER THAN A 55-56-57, ASK OUR CUSTOMER SERVICE REPS ABOUT CUSTOM AUTOSOUND'S FULL LINE OF AUDIO SYSTEMS AVAILABLE THROUGH DANCHUK.



#18019



#18018

CUSTOM AUTOSOUND SLIDEBAR RADIO

The Slidebar Radio is Custom Autosound's latest innovation in the quest for a perfect classic car radio. Just slide the "slidebar" to the right and the analog AM radio display drops away to reveal a full featured digital display. With the large OEM style push-buttons you get a perfect look in a classic dash. A radio that looks right and sounds great in your classic, it has the latest modern features that include an iPod dock.

Features Include:

- AM/FM RDS Tuner w/ 25 Pre-sets • RDS Tuner show Station/Song/Artist on LCD Display • 300 Watts Peak • 7 LCD Color Choices • LCD Dimmer Control • Bluetooth Option Available • iPod Dock and Control • USB Port for Flash Drive MP3/WMA Playback • Direct 6-Disc CD Changer Control • Alpha-Numeric Display for MP3/WMA/iPod Files • Electronic Tuning/Volume Control w/ Last Volume • Bass/Mid/Treble Tone Control • Loudness Compensation • DSP EQ • Front/Rear Fader • Left/Right Balance • Digital Clock • 2-Channel RCA Auxiliary Input for Satellite • 4-Channel RCA Pre-Outs • Subwoofer Line Out w/ Level & Cross Over Adjustments • Power Antenna Lead

- 1955-56 #18018..... \$299.95/ea.
- 1957..... #18019..... \$299.95/ea.



CUSTOM AUTOSOUND BLUETOOTH INTERFACE KIT

Custom Autosounds lets you add BlueTooth capability to their USA-630, Secret Audio and Slidebar Radios. Also listen to music stored on your A2DP enabled bluetooth device. If you have a CD changer or CD1 single player you can still use it with the adapter plugged in (there is a CD changer port on the control box of the Bluetooth kit). Main control box has a 1.5 foot cord that goes to radio CD port, 6.5 foot cord to answer button and 3.5 foot cord from answer button to microphone.

- All..... #18409..... \$109.95/kit



CUSTOM AUTOSOUND CONOURS SERIES USA-630 STEREO

This radio has large OEM style push-buttons that give a perfect look in a classic dash. Although it looks classic it has the latest modern features. USB input on the back of the radio allows you to plug in a USB flash drive for playback of MP3/WMA song files. New iPod interface with 3.5 foot docking cable. The new alpha numeric display shows the song/artist/album (id3) titles during playback of MP3/WMA and iPod files. Navigation for the iPod includes artist/song/album/playlist all from the buttons on the radio. With 300 watts the radio should have all the power you may need. The back of the radio also has auxiliary audio input for satellite radio or any portable player you may wish to use.

Features Include:

- AM-FM Stereo • RDS tuner shows station / song / artist on LCD display • 300 Watts (75w x 4) • USB Port for Flash Memory MP3/WMA Playback • iPod doc and control (Control your iPod from the buttons on the radio) • Direct 6 CD Changer Control • Negative LCD Display (Black background w/ white letters / numbers) • Alpha Numeric id3 Display for MP3/WMA files • Electronic Tuning and Volume Control • Loudness Compensation • Digital EQ • 4-Way Fader • Left Right Balance • Digital Clock • 2-Channel RCA Auxiliary Input for Satellite/Phone • 12 Pre-sets (12FM-4AM) • 4 Channel RCA Pre-outs • Separate Bass and Treble • USA/Euro Tuner • Power Antenna Lead

1955.....	#15230.....	\$259.95/ea.
1956.....	#15231.....	\$259.95/ea.
1957.....	#15232.....	\$259.95/ea.



**CUSTOM AUTOSOUND USA-740 STEREO
- NOW WITH BLUETOOTH 3.0**

Introducing Custom Autosound's latest, most advanced, and featured packed Stereo to date. This is truly one of their best radios to emulate the factory original radio with its chrome face, pushbuttons, and replica AM dial that all pay tribute to the style of the 50's. The classic good looks are only the beginning. With 300 Watts, 25 Presets (15FM/10AM) and full audio controls with DSP EQ and separate Bass/Mid/Treble controls you can tailor the sound to your liking and with 4 RCA pre-out plus subwoofer line-out you can add even more power easily. The USA-740 introduces Bluetooth technology that allows you to place and answer calls and stream your favorite music and programs from you personal device. You also get selectable and dimmable LCD colors of white, red, blue, cyan, green, yellow or pink to suit your tastes or mood. Featuring a rear mounded USB (w-Extension) Front and rear AUX inputs, RCA inputs for Satellite radio as well as CD/DVD player control for an add-on player (Part #18525) the possibilities are endless.

Features Include:

- AM/FM RDS Tuner w/ 25 Pre-Sets (15FM/10AM) • RDS Tuner Shows Station/Song/Artist on LCD Display • 300 Watts Peak 2-Ohm Stable • 7 LCD Color Choices White/Red/Blue/Cyan/Green/Yellow/Pink • LCD Dimmer Control • Clock or Function Display Priority (switchable) • Bluetooth and Remote Microphone Included • USB Port for Flash Drive MP3/WMA/FLAC/WAV Playback • Direct CD-I Control • Aux-In Front and Rear • Alpha Numeric Display for MP3/WMA/FLAC/WAV • Electronic Tuning • Volume Control w/ Last Volume Memory • Bass/Mid/Treble/Tone Control • Loudness Compensation for Low Volume Listening • DSP EQ • Front / Rear Fader • Left / Right Balance • Digital Clock • 2 Channel RCA Auxiliary Input for Satellite • Hi-Volt 4 Channel RCA Pre-outs • Hi-Volt Subwoofer Line Out w/ Level X-Over Adjustments • USA/EUR/JAP/RUS Tuner Capability (USA Default) • Auto Store - Fill Presets w/ Strongest Stations • Power Antenna Lead

1955.....	#18518.....	\$349.95/ea.
1956.....	#18519.....	\$349.95/ea.
1957.....	#18520.....	\$349.95/ea.



CUSTOM AUTOSOUND CD/DVD PLAYER

This new slim sized half DIN CD/DVD player can be controlled by Custom Autosound's USA-630, USA-740, Slidebar or Secret Audio.

Features Include:

- Plays CD/CD-R/CD-RW/DVD audio/WMA/MP3, Small enough to hide under the seat or in glove box, ESP Electronic Shock Protection, Repeat/ Program/Random/Intro Function, Multi-Angle Playback, Last Position Memory, 9' Cable for connection to CAM head unit.

Dimensions: 7" wide x 1" high x 6-3/4 deep
All 1/2-DIN #18525..... \$179.95/ea.



#789

#788

ANTENNA

ANTENNA ASSEMBLIES

The antenna is a high-wear item that needs periodic replacement. We've duplicated the 1955 with its unique teardrop top. The 1956-57 is correctly done with the round top. Assemblies come complete with base, nut, gasket, template, bracket, and instructions.

1955.....	#788.....	\$78.95/set
1956-57 (Shown)	#789.....	\$78.95/set



1957 REAR MANUAL DUMMY ANTENNA

If one looks cool, two look even better. When installed with the rear manual antenna, part #1177, this antenna completes the symmetrical, full-dress look. Although it is inoperable, it still makes a high-style impression. Don't tell anyone it's a dummy; you're the only one who will know!

1957 Passenger	#1176.....	\$169.95/ea.
----------------------	------------	--------------

CUSTOM AUTOSOUND HIDDEN ANTENNA

For the best AM/FM reception nothing works better than a 31-inch vertically mounted antenna mast. Mounts on the inside top of windshield for best performance. Not recommended for underdash mounting.



1955-57	#12087	\$34.95/ea.
---------------	--------------	-------------



1957 REAR MANUAL ANTENNA WITH CABLE

Another high-style option was this operable, rear mounted antenna. It angles back sharply, giving your car a faster, sexier look.

1957 Driver.....	#1177.....	\$169.95/ea.
------------------	------------	--------------

ANTENNA BASE

For those whose antenna bases are pitted or have lost their chrome we offer this original design Danchuk part. For front fender mounting antennas. Includes rubber gasket. **Made in the USA.**



1955-57	#302.....	\$24.95/ea.
---------------	-----------	-------------



1957 ELECTRIC REAR ANTENNA

The electric antenna was a true high-tech option in 1957, and it's still a favorite today. Kit includes coaxial cable, a brilliant chrome antenna base, mounting hardware, and antenna.

1957 Passenger	#1858.....	\$474.95/ea.
----------------------	------------	--------------

ANTENNA NUT

Time will oxidize and crack those original plastic antenna nuts. This easily replaced reproduction is another detail item that won't go unnoticed.



1955-57	#302A.....	\$6.95/ea.
---------------	------------	------------

1957 CHROME REAR ANTENNA BASES

Reproduction of the rear antenna base for original and reproduction rear antennas.



1957 Driver.....	#16573.....	\$39.95/ea.
1957 Passenger	#16574.....	\$39.95/ea.

5. Switches & Ignition

SECTION AT A GLANCE:

Ignition.....	262
Spark Plug Wires	266
MSD.....	267
Pertronix.....	270
Spark Plug Related	273
Switches.....	274



#119



#118

IGNITION RELATED

LOWER SPARK PLUG WIRE SUPPORT SHIELDS

Mounted to the engine block behind the exhaust manifolds, these shields protect the spark plug wires from damaging engine heat. Wires run through the rubber grommets, safely hidden behind the sheet metal shield. This shield is designed for use with the spark plug wire support brackets, part #1159 and #1160, shown below. Fits all 1957 passenger cars, 1956 dual 4-barrel and 1956-57 Corvettes as a correct reproduction, but also fits 1955-56 passenger cars as a good replacement. Don't let your pride and joy be without a pair of these beauties. **Made in the USA.**

1956-57 #1446.....\$35.95/pr.

IGNITION SWITCHES

Our switches are **Made in the USA*** and assembled right here in our California facility. We take great pride in every process that goes into these switches and have spared no expense in assuring that they are as perfect as you have come to expect from DanChuk. 1955-56 bezel, part #908, is sold separately and is shown on page 90. The 1957 retainer nut, part #910, is sold separately and is shown on page 90.

- 1955-56 Best, 55-57 Vette, & 55-59 Truck (Shown) #119* \$78.95/ea.
- 1955-56 Good, 55-57 Vette & 55-59 Truck #16693..... \$52.95/ea.
- 1957 & 58-59 Vette (Shown) #118* \$78.95/ea.
- 1960-62 Vette Only #1462..... \$87.95/ea.
- 1955-56 Ignition Ring Nut Tool (see page 90) #949* \$20.95/ea.

#1158



SPARK PLUG WIRE SUPPORT BRACKETS AND HARDWARE

All the brackets, grommets, and hardware you'll need to organize your spark plug wires.

- 1955 V8, 28-Piece #1158..... \$57.95/ea.
- 1956 V8, 27-Piece #1159..... \$57.95/ea.
- 1957 V8, 7-Piece #1160..... \$42.95/ea.

#118A



#119A

IGNITION SWITCHES WITH CYLINDERS AND KEYS

Roll back years of wear by replacing your old ignition switch with our quality reproduction. Lock cylinder may be keyed to your existing door locks. **Made in the USA.**

- 1955-56 #119A..... \$99.95/set
- 1957 & 1958-59 Vette #118A..... \$99.95/set



SPARK PLUG WIRES

Part of keeping your car in tune requires replacing your spark plug wires regularly. These are great replacements for the budget-minded. See pages 266-273 for additional wire sets.

- 1955-57 6-Cyl. #180..... \$27.95/set
- 1955-56 V8 #181..... \$35.95/set

1957 CHROME IGNITION SWITCH BEZEL

Our original design ignition switch bezels solve the problem. Bezels include recessed, painted letters on beautiful chrome plating. Markings read as clearly as they did on the original Chevy bezels. Please turn to page 612 for ignition lock sets, parts #385A and #385B.



- 1957..... #909..... \$15.95/ea.



CLASSIC UPDATE REPLACEMENT IGNITION SWITCHES

For use with American Autowire Classic Update series wiring kits (#11203-11204) ONLY and will not work with factory original harnesses.

- 1955-56 #17798..... \$39.95/ea.
- 1957..... #17799..... \$39.95/ea.



CLASSIC UPDATE REPLACEMENT IGNITION SWITCH CYLINDER WITH KEYS

For use with American Autowire Classic Update ignition switch part #17798 and #17799.

- 1955-57 #17800..... \$26.95/set



ORIGINAL STYLE IGNITION LOCK CYLINDER WITH KEYS

- 1955-57 #14248..... \$28.95/ea.



IGNITION SWITCH BEZEL NUTS

Use these rings to hold your ignition switch and plastic bezel (part #652 or #653) in your dash. Ignition ring tool can be found on page 90.

- 1955-56 & 55-57 Vette, Best..... #908..... \$14.95/ea.
- 1955-56 & 55-57 Vette, Good..... #16793..... \$8.95/ea.
- 1957 Best #910..... \$10.95/ea.
- 1957 Good #16794..... \$6.95/ea.

BALLAST RESISTOR COVER



This little beauty is made out of stainless steel with a mirror bright finish that mates perfectly with our other chrome products.

Made in the USA.

- 1955-57 Louvered #2510..... \$25.95/ea.

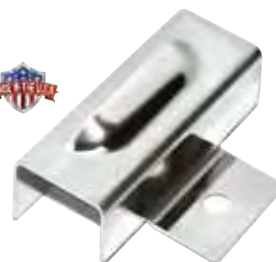

BOWTIE SPARK PLUG WIRE LINEAR LOOMS

Molded black plastic looms feature the bowtie and "Chevrolet" logo in red and are mounted on chrome stems.

- All SB..... #1942..... \$13.95/pr.

IGNITION BALLAST RESISTORS

These are a reproduction of the original item from Chevrolet. Installs on the firewall; the ballast resistor controls the voltage to the coil on start-up for both 6-cylinder and V8 applications, except dual 4-bbl or fuel injection. 2 Ohm resistance.

- 1955-56 #099..... \$27.95/ea.
- 1957-64 #099A..... \$27.95/ea.



HI-PERFORMANCE BALLAST RESISTOR

This is a reproduction of the original resistor that was used on cars equipped with dual 4-barrel carburetors or fuel injected.

- 1956-57 V8 Only #15065..... \$27.95/ea.





#096

#17160

IGNITION COILS

Part #096 is a Delco replacement for points style ignition system.

- 1955-57 #096..... \$44.95/ea.
- 1957 Fuel Injection, #107 Reproduction
- #17160..... \$89.95/ea.



BILLET LS COIL RELOCATION KIT WITH BRACKETS

Eddie Motorsports Billet Aluminum LS Coil Relocation brackets allow you to mount the coils together in a remote location. A must when you are installing aftermarket valve covers.

- All Machined #18317..... \$137.95/kit
- All Polished..... #18318..... \$161.95/kit

DISTRIBUTOR WIRE FIREWALL GROMMET

This grommet is another crucial, must-have part. Allowing this grommet to wear out is like asking for a major electrical problem. Located on the firewall.

- 1955-57 #822..... \$5.95/ea.



IGNITION COIL BRACKET CLAMP SCREW

- 1955-57 #15436..... \$0.95/ea.



#18313

#18314

BILLET LS COIL COVERS WITH OIL FILL CUT-OUT

Eddie Motorsports LS coil covers allow you to cover up the factory coils and dress up your LS based motor. Includes all mounting hardware.

- All Smooth, Machined #18313..... \$241.95/ea.
- All Smooth, Polished..... #18314..... \$241.95/ea.
- All Ball Mill, Machined #18315..... \$241.95/ea.
- All Ball Mill, Polished #18316..... \$241.95/ea.



BILLET SPECIALTIES DISTRIBUTOR CLAMPS

- All SB/BB, Polished..... #17090..... \$31.95/ea.
- All SB/BB, Black #19373..... \$33.95/ea.



IGNITION COIL BRACKET

- 1955-57 V8 2 & 4BC #15435..... \$15.95/ea.



V8 DISTRIBUTOR PARTS

Make your motor sing with these important parts.

1955-56, 57 Dual Point, Cap.....	#110.....	\$13.95/ea.
1955-56, 57 Dual Point, Rotor	#105.....	\$7.95/ea.
1955-56, 57 Dual Point, Condenser		
.....	#106.....	\$9.95/ea.
1955-56 Points	#101.....	\$14.95/ea.
1957 Cap	#108.....	\$14.95/ea.
1957 Points	#102.....	\$19.95/ea.
1957 Rotor.....	#103.....	\$5.95/ea.
1957 Condenser	#107.....	\$7.95/ea.

#1402

#1403

SINGLE FOUR BARREL, DUAL FOUR BARREL, AND FUEL INJECTION SHOW QUALITY SPARK PLUG WIRES

For the high-performance V8 series we offer these show quality original spark plug wires. You don't have to sacrifice originality. Manufactured in correct lengths and color combinations.

1955-56 V8, 4BC, 1st Design.....	#1400.....	\$84.95/set
1956 V8, 4BC, 2nd Design	#1401.....	\$84.95/set
1956 V8, Dual 4BC (Shown).....	#1402.....	\$84.95/set
1957 V8, 4BC (Shown)	#1403.....	\$84.95/set
1957 V8, Dual 4BC	#1404.....	\$84.95/set
1957 V8, Fuel Injection	#1405.....	\$84.95/set

6-CYLINDER DISTRIBUTOR PARTS

Regular attention to your distributor pays off in added performance and gas mileage.



1955-57 Cap.....	#109.....	\$13.95/ea.
1955-57 Points	#100.....	\$10.95/ea.
1955-57 Rotor.....	#104.....	\$8.95/ea.
1955-57 Condenser.....	#106.....	\$9.95/ea.



STAINLESS DISTRIBUTOR HOLD-DOWN STUDS

All Hex Head, V8	#14015.....	\$8.95/set
All 12-Point Head, V8	#14016.....	\$15.95/set



DISTRIBUTOR VACUUM LINES

1955-57 6-Cylinder (Not Shown)..	#1525.....	\$14.95/ea.
1955-57 2BC	#1275.....	\$19.95/ea.
1955-57 Carter 4BC	#1276.....	\$7.95/ea.
1955-57 Rochester 4BC.....	#1277.....	\$7.95/ea.

THUNDER-VOLT SPARK PLUG WIRES 

Taylor offers you the lowest resistance wires in the industry at only 50 ohms per foot which can give you more power, smoother idle and improved fuel economy. These spiral wound coated core wires have two layers of silicone and are RFI and EMI compatible for all ignition systems. Sold in universal sets with 90 degree plug boots.



- All Black, 8.2 mm, V8..... #13686..... \$94.95/set
- All Red, 8.2 mm, V8..... #13687..... \$94.95/set
- All Blue, 8.2 mm, V8..... #13688..... \$94.95/set



VERTICAL WIRE LOOM KITS

This wire loom kit allows the wires to be run vertically, close to the valve cover and away from excessive manifold heat. Will not work with center bolt valve covers.

- All Black, 7-8 mm, V8..... #12997..... \$31.95/kit
- All Red, 7-8 mm, V8..... #12998..... \$31.95/kit
- All Blue, 7-8 mm, V8..... #12999..... \$31.95/kit

SPARK PLUG WIRES

SPIRO-PRO SPARK PLUG WIRES 

Spiro-Pro wires feature spiral metal core to suppress radio interference, 100% silicone inner core, 8mm silicone outer jacket and double spring locking plug terminals. All sets are universal V8.



- All Black, 8mm, V8..... #12980..... \$78.95/set
- All Red, 8mm, V8..... #12981..... \$78.95/set
- All Blue, 8mm, V8..... #12982..... \$78.95/set

HORIZONTAL WIRE LOOM KITS

This wire loom kit allows the wire to run horizontal to the valve cover showing more of your wire set. This kit will fit valve covers with center bolts, but will require longer valve cover bolts. Longer bolts not included.



- All Black, 7-8 mm, V8..... #13003..... \$31.95/kit
- All Red, 7-8 mm, V8..... #13004..... \$31.95/kit
- All Blue, 7-8 mm, V8..... #13005..... \$31.95/kit

PRO-WIRE SPARK PLUG WIRES

Taylor's Pro-Wire are made of top grade silicone with an 8mm silicone jacket and comes with double spring locking plug terminals for a more secure fit. All Pro-Wire sets have suppressor core that eliminates radio interference. All sets are universal V8.



- All Black, 8 mm, V8..... #12984..... \$78.95/set
- All Red, 8 mm, V8..... #12985..... \$78.95/set
- All Blue, 8 mm, V8..... #12986..... \$78.95/set

POLISHED ALUMINUM SPARK PLUG BOOT HEAT SHIELDS

Snaps on over existing Taylor's Pro Boots and offers additional protection against heat from the exhaust system. Set of two.



- All 90°..... #12989..... \$25.95/set
- All 135°..... #12990..... \$31.95/set

TAYLOR STRIP & CRIMP TOOL

A must for stripping Spiro-Pro wire. Crimps terminals with the aid of a vise.



- All 8-10.44 mm Wire Sets..... #13009..... \$14.95/ea.



ADVANCE CURVE KIT FOR MSD DISTRIBUTOR

- This is the kit that is included in all MSD distributors.
- All..... #13894..... \$21.95/kit



#13888

#13887

#13889

#13885

MSD PRO-BILLET DIGITAL E-CURVE BILLET DISTRIBUTOR

This distributor will drop right in and is easy to connect. Not only are there no external controls or boxes to hook up, you can set the timing curve with a twist of the rotary dial. That's right, no more springs or stops to change and you have nearly 100 advance curves, including vacuum advance to choose from. The module also has a rev-limiter, making this one of the most advanced distributors available. All..... #13888..... \$539.95/ea.

MSD STREET PRO-BILLET DISTRIBUTOR

The MSD Street Pro-Billet distributor with the use of an MSD 6, 7, 8 or 10 series ignition box gives you race proven performance for your street car. The vacuum advance provides economy while the mechanical advance allows you to dial it in. All..... #13889..... \$289.95/ea.

MSD PRO-BILLET READY-TO-RUN DISTRIBUTOR

This distributor does not require an ignition box and is the perfect upgrade for an outdated ignition system. Be sure to order an MSD Blaster coil to complete your upgrade. All..... #13887..... \$399.95/ea.

MSD PRO-BILLET HEI DISTRIBUTOR

The HEI distributor is a popular upgrade for classic cars. Its integrated design and one wire hook up makes installation clean and simple. MSD improves the HEI by installing their digital module with rev-limiter and matching coil to give you performance up to 9,000 RPM. All..... #13885..... \$499.95/ea.

MSD DISTRIBUTOR CAP AND ROTOR

MSD cap and rotor kits are a great improvement over regular parts house replacements.

All GM HEI..... #13890..... \$41.95/kit

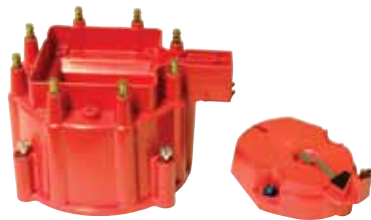

MSD MAGNETIC PICK-UP FOR BILLET DISTRIBUTORS

This MSD replacement pickup is the same high output assembly that is found in all MSD distributors, not for use on OEM distributors.

All..... #13895..... \$37.95/ea.



MSD BILLET DISTRIBUTOR HOLD-DOWN CLAMP

All..... #13897..... \$39.95/ea.



Ignition

MSD



MSD SPARK PLUG WIRES

MSD's 8.5mm Super Conductor is the ultimate performance wire. Its extremely low resistance (50 OHM's per ft) copper alloy conductor means more energy is going to the spark plug. The core also suppresses Electro Magnetic Interference (EMI).

All Red #13901 \$129.95/set



MSD STREET FIRE SPARK PLUG WIRES

Street Fire wires are 8mm spiral wound to prevent EMI and have a silicone jacket and boots that resist heat and abrasion. The 50 ohms per foot resistance improves spark delivery and power.

All V8, SB/BB #15154 \$56.95/set



MSD BALLAST RESISTOR

For use with an MSD Blaster Coil when connected to a stock point ignition system.

All 0.8 OHM #13904 \$12.95/ea.



MSD UNIVERSAL COIL BRACKET

All #13881 \$10.95/ea.



MSD COILS

If you are looking to upgrade your stock coil or want to compliment the performance of your MSD ignition, Blaster coils are the perfect choice. Note: When you are using an MSD ignition control, the ignition box sends the voltage to the coil so a ballast resistor is not needed.

All Blaster 2, 45K Volts, Red #13877 \$59.95/ea.

All Blaster 2, 45K Volts, w/ Wall Tower #13878 \$59.95/ea.

All Blaster 2, w/ Ballast Resistor, Chrome #13879 \$62.95/ea.

All HEI, 42K Volts #13880 \$95.95/ea.



#18522

MSD LS COIL BRACKETS

These new brackets are made from cast aluminum with a machined finish for great looks. Brackets include mounting hardware and accept either OEM coils or MSD Coils.

All LS1/ LS6 #18521 \$119.95/pr.

All LS2/ LS7 #18522 \$119.95/pr.

MSD SPARK PLUG WIRE MINI STRIPPER CRIMPER

This special tool is an inexpensive way to make a set of custom plug wires and works with both 8 and 8.5 mm plug wires.

All #13903 \$11.95/ea.





MSD IGNITION CONTROLS

The new digital 6AL, #16575 and #16576, feature higher output with 530 primary volts and 135mJ of spark energy, efficient components use less current to produce more power, ability to set an RPM limit on the 6AL with two rotary dials, same bolt pattern as the original 6AL with a lower profile housing, built-in LED for system checks, all wires exit the same side through a locked, sealed connector, compatible for 4, 6 or 8-cylinder engines and are compatible on engines with 12-volt, negative ground electrical systems. They'll accept trigger inputs from breaker points, amplifiers and magnetic pickups. And include the wiring harnesses and the components you'll need for installation. Part #16575 features Soft Touch Rev control, and is also supplied with vibration mounts.



- All 6A..... #16576..... \$254.95/ea.
- All 6AL, w/ Rev-Limiter..... #16575..... \$315.95/ea.
- All 6AL-2..... #15155..... \$359.95/ea.

MSD LS SERIES IGNITION CONTROLLER BOXES

MSD's improved version of their popular 6LS box provides the control you need to achieve the performance you want for your LS conversion. Dial in the perfect tune for your LS using the easily adjustable preset timing curves or hookup to your computer and program a custom setup with their user friendly MSD View software. New features of the LS Ignition include; high speed data acquisition, an optional coolant temperature sensor input, idle timing control, as well as individual cylinder timing. These features are in addition to the existing programmable step retard, launch retard and RPM rev limiters from its predecessor. Can be used with carbureted or fuel injected engines and will work with both 24x and 58Xx crank trigger engines.

- All Red..... #18531..... \$374.95/ea.
- All Black..... #18532..... \$374.95/ea.



#13893



#2106

MSD VACUUM ADVANCE CANISTER EXCEPT HEI

This replacement canister is for MSD distributors with vacuum advance, except the HEI distributor.

- All..... #13893..... \$21.95/ea.

OE STYLE VACUUM ADVANCE

- 1955-56 V8 #2106..... \$49.95/ea.



MSD STREET FIRE CDI IGNITION BOX

The Street Fire is a Capacitive Discharge Ignition system and is perfect for performance applications on a budget. Features an adjustable, plug in module, rev-limiter, cast aluminum body and easily connects to points, amplifiers and magnetic pickup distributors.

- All w/ Rev-Limiter #15153..... \$164.95/ea.



#2863



#2290

DISTRIBUTOR VACUUM ADVANCE

- 1957-70 V8, Service Replacement #2863..... \$19.95/ea.

VACUUM ADVANCE COVER

- Detail your engine compartment with this polished, chrome plated cover. Adhesive backing makes installation easy.
- All..... #2290..... \$3.95/ea.



PERTRONIX IGNITION CONVERSIONS

Upgrade from obsolete breaker points to an electronic system with an easy clean installation. The Ignitor system has been called the "stealth" ignition system because it's powerful and is practically undetectable underneath your distributor cap. Ignitor III gives you more performance, plus an adjustable rev-limiter.

1955-57 Ignitor, 6-Cyl.	#12382.....	\$119.95/kit
1955-56 Ignitor, V8	#12383.....	\$99.95/kit
1957-74 Ignitor, V8	#12384.....	\$98.95/kit
1957-74 Ignitor II, V8.....	#12385.....	\$133.95/kit
1957-74 Ignitor III, V8.....	#15679.....	\$165.95/kit



PERTRONIX DIGITAL HP IGNITION

The new Digital HP Ignition Box delivers over 187 mJ of spark energy and features an integrated 3 step digital REV limiter. Continuing the PerTronix standard the Digital HP also delivers multiple spark all the way to redline. Key features include an RPM triggered output, adjustable start retard, locking automotive connector, tachometer output lead, and onboard diagnostics and tach calibration all in an ultra small form factor.

All Black	#18842.....	\$239.95/ea.
All Silver	#18843.....	\$239.95/ea.



PERTRONIX IGNITOR II DISTRIBUTOR REPLACEMENT MODULE

Only fits Pertronix billet distributors.

All.....	#14260.....	\$99.95/ea.
----------	-------------	-------------



PERTRONIX FLAME-TROWER IGNITION COILS

When your goal is a great spark, every component in the ignition system is important. Don't let your coil be the "weak link". To maximize energy and increase reliability over the entire RPM range, choose from the two styles of ignition coils now available at DanChuk. Canister style oil filled coils are available in chrome and black. The Flame-Thrower 40,000 volt coil is designed for use with the Ignitor ignition system, but can be used with other induction ignition systems. The Flame-Thrower II 45,000 volt coil is a super low 0.6 OHM resistance coil designed for use with the Ignitor II and is compatible with capacitive discharge systems. Flame-Thrower III coils are ultra-low .32 OHM coils and are compatible with Ignitor II and III distributors and modules.

All Chrome, 40K Volt.....	#12393.....	\$43.95/ea.
All Black, 40K Volt	#12394.....	\$38.95/ea.
All Flame-Thrower II, Chrome, 45K Volt	#12395.....	\$47.95/ea.
All Flame-Thrower II, Black, 45K Volt	#12396.....	\$42.95/ea.
All Flame-Thrower E-Core, HEI, 50K Volt	#12388.....	\$39.95/ea
All 6-Cyl., Black, 40K Volt, 3 OHM	#12733.....	\$37.95/ea.
All Flame-Thrower III, 45K Volt, Chrome	#15680.....	\$49.95/ea.
All Flame-Thrower III, 45K Volt, Black	#15681.....	\$39.95/ea.

PERTRONIX FLAME-TROWER IGNITION MODULE

Develops 67% more energy than an OEM module and when teamed with the Flame-Thrower coil operates misfire free up to a minimum of 7500 RPM. Use with HEI distributor.

All.....	#12387.....	\$45.95/ea.
----------	-------------	-------------





PERTRONIX FLAME-THROWER BILLET DISTRIBUTORS

Now you can update your outdated points, stock electronic or aftermarket distributor with a performance proven distributor that features a patented Ignitor II or Ignitor III electronic ignition module. Housings are CNC machined from 6061-T6 aluminum and polished to a show quality finish. Parts #12736 and #12737 have tower style male connectors. Ignitor III “plug n play” billet distributors are designed for maximum ignition performance and easy installation, parts #15684 and #15685 distributor caps have male HEI wire towers. Ignitor III gives you more performance, plus an adjustable rev-limiter.



All Ignitor II, Black Cap, w/ Female Terminals.....	#12392.....	\$249.95/ea.
All Ignitor II, Black Cap, w/ Male Terminals, V8.....	#12736.....	\$249.95/ea.
All Ignitor II, Red Cap, w/ Male Terminals, V8.....	#12737.....	\$249.95/ea.
All Ignitor II, Red Cap, w/ Female Terminals	#15049.....	\$249.95/ea.
All Ignitor III, Black Cap, w/ Female Terminals.....	#15682.....	\$279.95/ea.
All Ignitor III, Black Cap, w/ Female Terminals.....	#15683.....	\$279.95/ea.
All Ignitor III, Black Cap, w/ Male Terminals.....	#15684.....	\$279.95/ea.
All Ignitor III, Red Cap, w/ Male Terminals.....	#15685.....	\$279.95/ea.

PERTRONIX FLAME-THROWER HEI DISTRIBUTORS

Experts agree that good HEI ignition systems rely on a good module and a good coil. Pertronix has engineered their module and coil to work together to provide superior ignition performance without misfires up to a minimum of 7500 RPM, nearly 3000 RPM higher than most report with their original HEI. Compared to the stock HEI, this unit produces 67% more energy in the coil with 45% faster spark breakdown time to deliver twice the energy across the spark gap. Legal in all 50 states.

All HEI, Black Cap.....	#12386.....	\$249.95/ea.
All HEI, Red Cap	#15052.....	\$249.95/ea.

PERTRONIX STOCK LOOK IGNITOR III DISTRIBUTOR

All the performance of the billet distributors in a stock “Sleeper Look”. All new cast housings molded after the original Delco distributors. Tailored advance curve for optimum performance and drivability. Adjustable vacuum canisters for extra tunability. High dielectric strength cap and rotor with brass contacts. Legal in all 50 states.

All SB/BB.....	#16905.....	\$239.95/ea.
----------------	-------------	--------------

PERTRONIX SECOND STRIKE IGNITION BOX

Second Strike is the only ignition to provide a powerful second spark throughout the entire RPM range and is a great supplement to most existing ignition systems. A powerful second spark results in a more complete burn of the fuel/air mixture. Increasing burn time at high RPM levels also reduces misfires resulting in more peak horsepower. The built-in digital rev-limiter protects the engine from possible over rev and is easily set with a simple rotary switch. Compatible with standard breaker points, GM HEI 4-PIN, Accel, DUI, Mallory, and MSD (ready to run).



All..... #12738..... \$289.95/ea.

PERTRONIX



PERTRONIX FLAME-THROWER TUNE-UP KIT

Everything you need to “wake up” your stock Chevy distributor. Kit includes street/strip module and coil combination, premium rotor and cap, custom Flame-Thrower coil cover, adjustable vacuum advance canister, hi-performance advance kit, wire harness and capacitor and complete installation hardware.

All HEI Dist..... #12391..... \$124.95/kit



PERTRONIX DISTRIBUTOR CAPS AND ROTORS

These high quality replacements fit Pertronix billet distributors, not their HEI.

All Black, w/ Male Terminals, V8.. #12734..... \$36.95/ea.

All Red, w/ Male Terminals, V8..... #12735..... \$39.95/ea.

All Red, w/ Female Terminals..... #15050 \$29.95/ea.

All Black, w/ Female Terminals..... #15051 \$29.95/ea.



PERTRONIX VACUUM ADVANCE CANISTER

Allows you to optimize ignition advance for maximum throttle performance. Fits both small and big block HEI.

All HEI, Adj..... #12390..... \$19.95/ea.



PERTRONIX FLAME-THROWER SPARK PLUG WIRES

Now you can get high performance with a stock look. The 7mm wires have no lettering and will work in your stock looms. 8mm does have lettering. Universal V8 applications.

All 7 mm, Stock Look..... #12397..... \$52.95/set

All 8 mm, w/ Lettering..... #12398..... \$57.95/set



PERTRONIX PERFORMANCE ADVANCE CURVE KIT

Precision stamped weights and center plate eliminate erratic timing . . . three sets of springs and complete installation instructions make recurving easy.

All HEI Dist..... #12389..... \$11.95/kit



BILLET SPECIALTIES BALL MILL SPARK PLUG WIRE LOOMS

Fits up to 9 mm wires.

- All..... #17088..... \$85.95/pr.
- All w/ Bowtie #17089..... \$89.95/pr.



SPARK PLUG WIRE LINEAR LOOMS

Keep your spark plug wires neatly arranged with these beautiful chrome looms. The Chevrolet divisional emblem is epoxy coated and located at the center of the looms. Wire holders are chrome and have a hidden fastener to keep the surface free of screw heads. Technical Note: Check your exhaust manifolds before ordering part #1940. To properly mount these looms, exhaust manifolds must not rise above the surface of the valve cover mounting flange.

- All SB #1940..... \$81.95/pr.
- All BB..... #1941..... \$106.95/pr.

EDELBROCK ULTRA-SPARK UNIVERSAL PLUG WIRE SETS

Max-Fire® Universal spark plug wire sets feature the same high quality as the Edelbrock model specific sets, but give you the flexibility to tailor them to fit your V8 application perfectly. Each kit has the spark plug boot pre-installed from the factory and they include early OEM socket style and late style HEI plug distributor terminals to make sure your covered. Each kit includes 8 spark plug wires (varying lengths), 11 points style terminals, 11 HEI plug style terminals, 9 straight distributor boots, 9 90° distributor boots, 1 distributor to coil wire and dielectric grease.

- All Ultra-Spark 500 OHM..... #18776..... \$45.95/set
- All Ultra-Spark 50 OHM..... #18777..... \$65.95/set



LATE MODEL (CENTER BOLT) WIRE LOOM BRACKET KIT

- All..... #18496..... \$16.95/kit



PERTRONIX HIGH TEMP UNIVERSAL PLUG WIRES WITH CERAMIC PLUG BOOTS

Pure 8 mm silicone jacket is rated to 600° F and the ultra high temp ceramic spark plug boots are rated to an astounding 2000°.

- All..... #18839..... \$92.95/set



UNIVERSAL METALLIC CORE SPARK PLUG WIRES

This universal plug wire set will work for both 6-cylinder and V8 applications. These feature a copper wire core and offer no RF filtering giving you solid core wire performance. May cause interference with some electronics such as radios and Vintage Air Gen IV systems.

- All..... #16531..... \$39.95/set

SPARK PLUG BOOT SHIELDS

Protect your spark plug wire ends from the excessive heat of the exhaust manifold.



- 1957-70 V8 283 (Fits 58-79 Vette) #874..... \$19.95/set

SPARK PLUG WIRE RUBBER SEPARATOR GROMMET

Details like these don't go unnoticed. Keep your engine compartment in order with this inexpensive part.



- 1955-57 V8 #220..... \$3.95/ea.

SWITCHES



CLASSIC UPDATE REPLACEMENT HEADLIGHT SWITCH WITH CONNECTOR

For use with American Autowire's Classic Update series wiring kits (#11203-11204) ONLY and will not work with factory original harnesses.

1955-57 #17803..... \$29.95/ea.

CLASSIC UPDATE REPLACEMENT HEADLIGHT SHAFT WITH KNOB

For use with part #17803 ONLY. Will not work with an original switch.

1955-56 #17801..... \$26.95/ea.



CLASSIC UPDATE REPLACEMENT HEADLIGHT SWITCH RETAINING NUT

For use with cars equipped with American Autowire's Classic Update wire harnesses only.

1955-56 #17802..... \$13.95/ea.

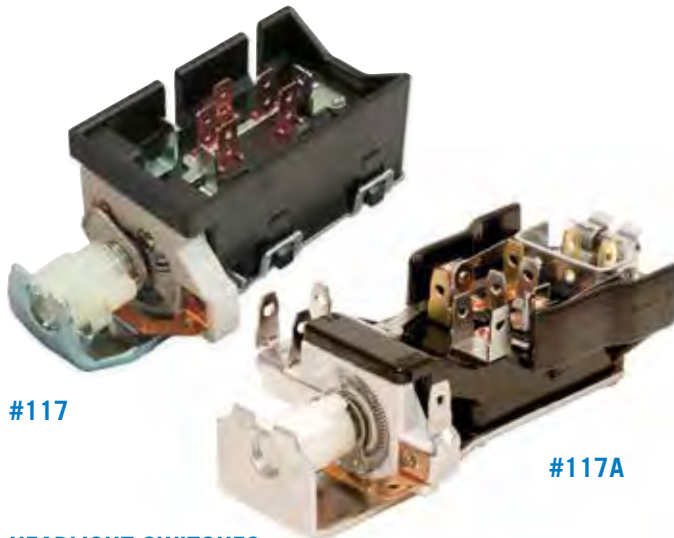

#117

#117A

HEADLIGHT SWITCHES

A much needed part, without these your headlights and dash lights will be dark. Our #117A is an exact reproduction of the GM original with the built in fuse. So, if your original is giving you trouble, we have the switch for you.

1955-56, '55-59 Trucks, '55-57 Vette #117A..... \$39.95/ea.
1957-63 #117..... \$29.95/ea.

CLASSIC UPDATE REPLACEMENT HEADLIGHT SWITCH RETAINING NUT

For use with cars equipped with American Autowire's Classic Update wire harnesses only.

1955-56 #17802..... \$13.95/ea.



#12731

HEADLIGHT KNOBS AND SHAFT

1955..... #12218..... \$13.95/ea.
1956..... #12731..... \$13.95/ea.
1957 (fits 58-60 Vette) #885..... \$13.95/ea.



#1124

#1123

DOME LIGHT SWITCHES AND GASKETS

Any part that sees as much use as the dome light switch is going to need periodic replacement. We've manufactured these switches to meet the demands of daily use, while paying careful attention to original detail. Switches fit the front pillars, with gaskets and screws included.

1955-56 #1124..... \$21.96/ea.
1957..... #1123..... \$21.95/ea.
1955-56 Gaskets Only #917..... \$1.95/pr.
1957 Gaskets Only..... #917A..... \$1.95/pr.
1955-62 Corvette #90726..... \$21.95/ea.

1955-56 HEADLIGHT SWITCH RETAINING NUT

1955-56 Stainless #13845..... \$19.95/ea.

1957 HEADLIGHT SWITCH RETAINING NUT

1957 w/ Nylon Insert #11206..... \$12.95/ea.

STOP LIGHT SWITCH

Keep your car safe by maintaining those old lamps and switches. With this quality reproduction installed you'll be sure the guy behind you knows when you're stopping.

1955-57 #116..... \$21.95/ea.



#10214

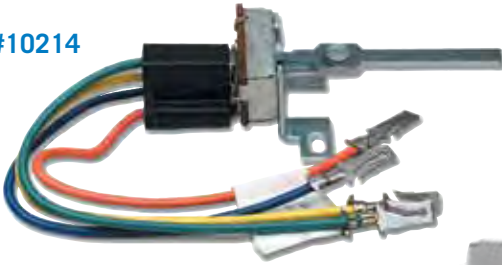

#10213



BLOWER SWITCHES

A reproduction of the original, these deluxe heater blower switches will get your heater working again like new. On part #10213, install wires with care to avoid damaging.

- 1955-56 #10213..... \$39.95/ea.
- 1957..... #10214..... \$49.95/ea.

HORN RELAYS

Replace your damaged or burnt out relay. Then you can toot your own horn and let the world know you've arrived.



- 1955-56 #111 \$19.95/ea.
- 1957..... #112..... \$19.95/ea.

WINDSHIELD WIPER SWITCH CONTROL CABLE ASSEMBLY AND HEADLIGHT SWITCH RETAINER NUT TOOL

This tool is a must when replacing light and wiper switches. Without this handy implement it is very easy to damage those plastic bezels. NOTE: This tool does NOT work for 1955-56 headlight switch retaining nuts.



- 1955-57 Wiper Switch..... #913..... \$16.95/ea.
- 1957 Headlight Switch Nut #913..... \$16.95/ea.



TORQUE CONVERTER LOCK-UP SWITCH

This wire and switch kit allows the installation of computer controlled transmissions without all the work involved to install the computer control unit.

- All 700R4/200-4R #12347..... \$79.95/ea.



GLOVE BOX LIGHT SWITCH ASSEMBLIES

For some it has been so long since these lamps operated that they are almost forgotten. If your lamp switch is on the blink, take advantage of our plentiful supply and replace it.

- 1955..... #457 \$19.95/ea.
- 1956-57 #17509..... \$19.95/ea.



TURN SIGNAL FLASHER

If your turn signal no longer works, fixing it may be something as simple as replacing the turn signal flasher.

- 1955-59 #115..... \$8.95/ea.



BACK-UP LIGHT SWITCH

This part is NOS. For standard transmission.

- 1955-56 #12149. \$26.95/ea.



4-WAY CONNECTOR

This connector is used for the TH200-4R, TH700-R4 torque converter lockup. Complete with terminals.

- All..... #12351 \$6.95/ea.



SNUB-NOSE VOLTAGE REGULATOR/HORN SCREWS

- 1955-64 #2901..... \$4.95/set

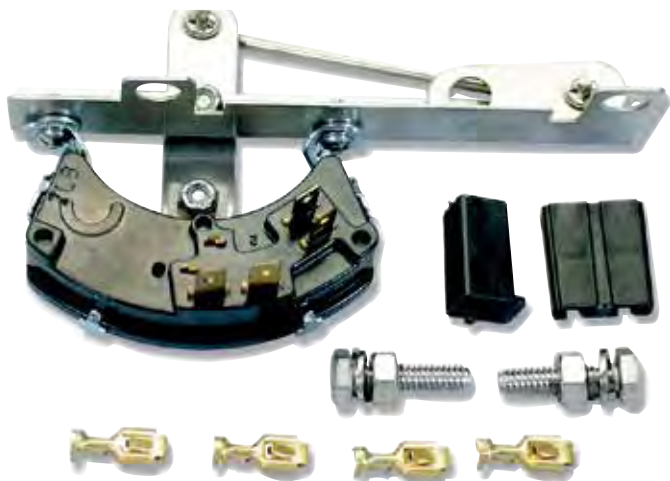

NEUTRAL SAFETY/BACK-UP LIGHT SWITCH ASSEMBLIES

These complete assemblies are for use on the TH350 and 400 transmissions. All necessary mounting hardware and connectors are included.

- 1955-57 TH350 #1345..... \$115.95/ea.
- 1955-57 TH400 (Shown) #1346..... \$115.95/ea.



NEUTRAL SAFETY BACK-UP LIGHT SWITCHES

Without this important part, your car won't start. Part #035 will also work for TH350/400, 200-4R and 700-R4 applications on 57 columns as a bolt in and on 55-56 columns with minor modification.

- 1955-56 Powerglide..... #1104..... \$26.95/ea.
- 1957 Powerglide #1105..... \$26.95/ea.
- 1957 Turboglide (Fits '64-'66)..... #035..... \$17.95/ea.



DIMMER SWITCHES

Even the most reliable switch must wear out eventually. Not to worry, these reproductions are easily installed.

- 1955-56 #113..... \$26.95/ea.
- 1957 Best, & 57-60 Vette #114..... \$28.95/ea.
- 1957 Good, & 57-60 Vette #16692..... \$17.95/ea.



BILLET SPECIALITIES DIMMER SWITCH COVERS

- 1955-57 Polished..... #17113..... \$16.95/ea.
- 1955-57 Black..... #17114..... \$16.95/ea.

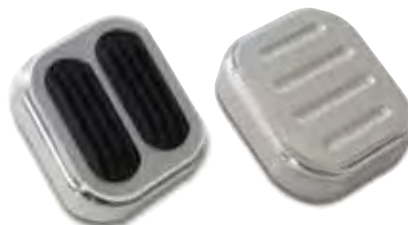

BILLET ALUMINUM DIMMER SWITCH COVERS

- 1955-57 Ball-Milled #12177..... \$29.95/ea.
- 1955-57 w/ Rubber Inserts..... #12178..... \$29.95/ea.



NEUTRAL SAFETY OR BACK-UP LIGHT SWITCH KIT

This kit offers the choice of back-up light switch or neutral safety switch kit. Kit fits TH350, TH400, TH700R4, TH2004R, 4L60, 4L60E and 4L80E transmissions. Single trigger for back-up light switch, or double trigger for neutral safety switch. KIT NOT INTENDED TO FUNCTION AS BOTH. All mounting hardware included. Works with Lokar and may work with others.

- All Auto #15880..... \$49.95/kit

6. Under the Hood

SECTION AT A GLANCE:

Firewall	278
Firewall Grommets	280
Hood Hinges	284
Hood Related	287
Horns	291
Valve Covers	292
Engine Dress-Up.....	295
Breather Caps	298
Russell Fittings	300
Thermo-Tec	302

FIREWALL



CUSTOM FIREWALL  

These beautiful OE style reproductions are “part custom”. Many of the holes that were originally in the firewall have been purposely left filled in so that you can customize them to your own personal needs.

1955-56 (Shown)	#17961.....	\$619.95/ea.
1957.....	#16888.....	\$549.95/ea.



#15468



#19299

REPLACEMENT SMOOTH FIREWALL PANELS 

1957 will require trimming.

1955-57 w/ 4" Setback	#15468.....	\$489.95/ea.
1955-57 w/ 4" Setback, Custom Curved	#19299.....	\$499.95/ea.



FIREWALL HARNESS CONNECTORS AND GROMMETS

Complete with all terminals, connector bodies and grommets.

1956-57	#18275.....	\$15.95/set
---------------	-------------	-------------



FIREWALL SEAL RETAINER CLIPS

Factory style firewall pad retainer clips come in seven piece sets and are used to retain the pad and the steering column seals.

1955-56 7-Piece.....	#17769.....	\$18.95/ea.
----------------------	-------------	-------------



1957 REALDUCTION AIR INDUCTION SYSTEMS

The RealDuction front fender air induction system is the easiest way to get fresh air to your LS or other custom fresh air induction system. Made from sturdy 18-gauge steel and powdercoated black, these install in the front fender in place of the stock fresh air fender ducting with your existing sheet metal screws and allows proper installation of the front headlight bucket. The single fender kit includes one front fender air duct panel with 4-inch tubes and one firewall block off panel. The dual fender kit includes two front fender air duct panels with 4-inch tubes and two firewall block off panels.

- 1957 Single Fender** #18645..... \$229.95/ea.
- 1957 Dual Fender (Shown)**..... #18646..... \$299.95/ea.

1957 REALDUCTION FRESH AIR DUCT BLOCK-OFF PANELS

These front fender and firewall block-off panels allow you to easily and cleanly remove the fresh air ducts from your classic. Made from sturdy 18-gauge steel and powdercoated black, these install on the front fender and firewall with your original sheetmetal screws. Using the front fender block off your front headlight buckets will install just like when the fresh air ducts were there and the firewall block-off plates cover the holes left by the vents.

- 1957 Firewall Plates Only** #18643..... \$47.95/pr.
- 1957 Fender Block-Off**..... #18644..... \$154.95/pr.



#10051

1957 FIREWALL PLATE

- 1957 Heater Block-Off Plate w/o Heat or A/C**
..... #10051..... \$178.95/pr.



1957 FIREWALL PLATE LOCKS

- 1957 Polished Aluminum** #10053..... \$37.95/set



FIREWALL-TO-HOOD SEAL CLIPS

For use with the firewall to hood seals, parts #555 and #556, shown below.

1955-56	#605A	\$3.50/set
1957	#605	\$3.50/set

GROMMETS



FIREWALL BOLT SET

Our set includes all the hardware needed to attach everything from the dimmer switch to a standard master cylinder, flat washers, split washers, split lock washers, and fasteners.

1955-56	#2258	\$19.50/set
---------------	-------------	-------------



INNER FENDER WIRE HARNESS CLIPS

Made in the USA.

1955-57	#1006	\$49.95/set
---------------	-------------	-------------

FRONT FENDER ANTENNA PLUG

For cars that do not have antennas, this plug seals the hole in the body inside the fender.

1955-57	#804	\$4.95/ea.
---------------	------------	------------



RUBBER BUMPER KITS

These kits contain bumpers for the doors, trunk, glove box and hood. Nomad kits do not include tailgate bumpers, #1822, found on page 654. Hood side bumper not included.

1955-57 2-Door Sedan (Shown) ...	#224	\$14.95/kit
1955-57 4-Door Sedan	#224A	\$20.95/kit
1955-57 2-Door Wagon	#224B	\$16.95/set
1955-57 4-Door Wagon	#224C	\$19.95/set
1955-57 2-Door Hardtop, Conv. & Nomad	#223	\$14.95/kit
1955-57 4-Door Hardtop	#223A	\$15.95/kit

FIREWALL-TO-HOOD SEALS

This is a must-have item, and is easily replaced. Clips and mounting hardware are available, see parts #605 and #605A shown above.

Made in the USA*.

1955-56 Best, 55-57 Truck	#555*	\$14.95/ea.
1955-56 Good, 55-57 Truck	#16709	\$9.95/ea.
1957	#556*	\$14.95ea.



1955 STARTER HARNESS (EARLY) AND CONVERTIBLE TOP MOTOR HARNESS GROMMET

This grommet fits up in the firewall behind the battery for the starter harness on early 1955's, and the convertible top power wire passes through this grommet before it connects to the convertible top switch.

1955 Best	#915	\$6.95/ea.
1955 Good	#16720	\$2.95/ea.



1957 SPEEDOMETER CABLE GROMMET

This grommet mounts in a hole in the firewall on the driver side at the top of the toe board, next to the steering column. The speedometer cable runs through it to the inside of the car where it connects to the speedo in the instrument cluster.

1957	#823	\$4.95/ea.
------------	------------	------------





FIREWALL RINGS

These firewall rings offer you a really neat way to keep your firewall looking as good as the rest of the car. Sized for heater hoses or AC hose they feature a threaded back and an ABS nut to keep them in place. Split a length of heater hose and you can use them to route wires neatly as well.

- All Black, 1/2" Heater Hose or A/C #6 #19076..... \$20.95/ea.
- All Polished, 1/2" Heater Hose or A/C #6 #19077..... \$20.95/ea.
- All Machined, 1/2" Heater Hose or A/C #6 #19078..... \$20.95/ea.
- All Black, 5/8" Heater Hose or A/C #8 #19079..... \$20.95/ea.
- All Polished, 5/8" Heater Hose or A/C #8 #19080..... \$20.95/ea.
- All Machined, 5/8" Heater Hose or A/C #8 #19081..... \$20.95/ea.
- All Black, 3/4" Heater Hose or A/C #10 #19082..... \$20.95/ea.
- All Polished, 3/4" Heater Hose or A/C #10 #19083..... \$20.95/ea.
- All Machined, 3/4" Heater Hose or A/C #10 #19084..... \$20.95/ea.



PARKLIGHT, HEADLIGHT AND HORN WIRE GROMMETS

Four of these grommets protect the park light and head light wires when they go through the inner fenders. The other two install in the filler panel to protect the wire at the radiator support pass through.

- 1955-56 #834..... \$5.95/set

1955 Firewall Grommets

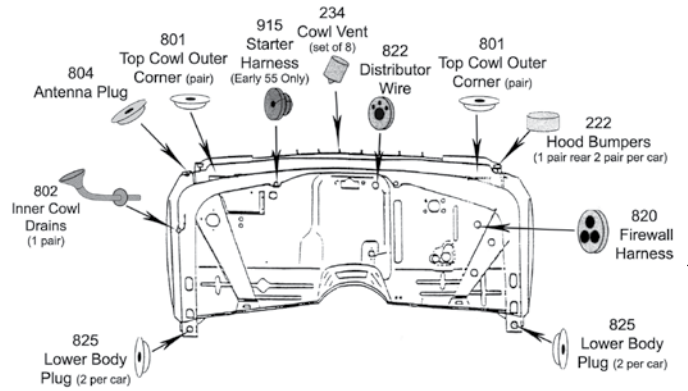

1956 Firewall Grommets

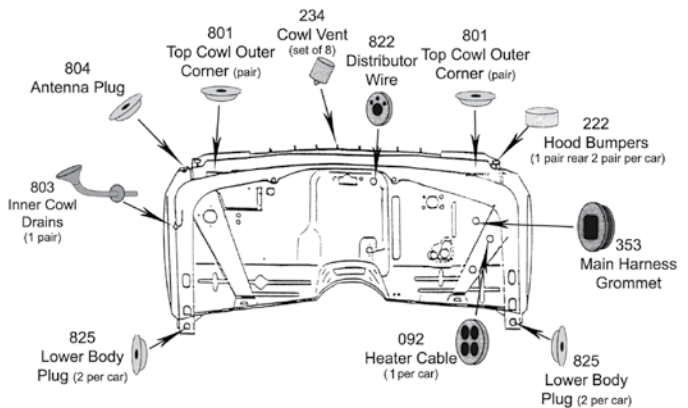

1957 Firewall Grommets

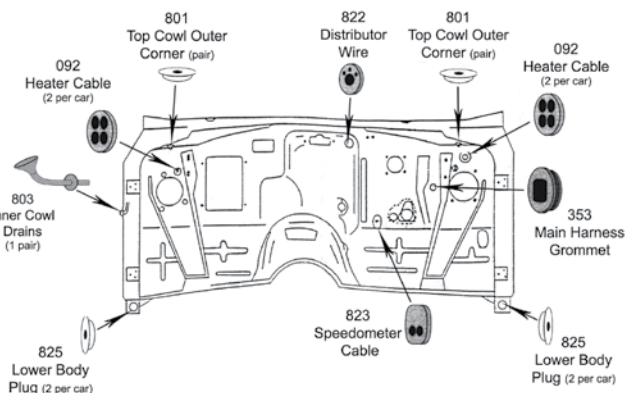



A-ARM DUST SHIELDS 

These shields are made exactly like Chevy's first design. Their primary job is to keep dirt out of the engine compartment, but engine heat and the elements are their chief enemy. Don't forget these important parts when restoring the engine compartment. Finish the job with new dust shield retainers (#2053 & 2054).

Made in the USA.

1955-56 (Shown)	#546	\$13.95/pr.
1957	#547	\$14.95/pr.

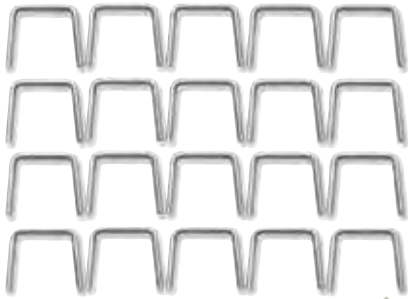

STAINLESS A-ARM DUST SHIELD STAPLES 

Make your restoration complete by mounting your a-arm dust shields to the inner fenders with these authentic stainless steel staples. **Made in the USA.**

1955-56	#2181	\$4.95/set
---------------	-------------	------------



A-ARM DUST SHIELD RETAINERS 

Part #2053 was also used on late 1955 models. Check your car before ordering.

1956 w/ Staples	#2053	\$12.95/set
1957 w/ Fasteners	#2054	\$19.95/set

FIREWALL WIRE HARNESS GROMMETS 

Part #820 installs on the driver side of the firewall between the column and inner fender. The dimmer switch wires, main underwood harness and the speedo cable thread through this grommet. Part #353 installs higher on the firewall and the connector block between the under dash harness and headlight generator where they plug together is located here. **Made in the USA*.**



1955 Best	#820	\$6.95/ea.
1955 Good	#16717	\$3.95/ea.
1956-57	#353	\$9.95/ea.

DISTRIBUTOR WIRE FIREWALL GROMMET

The distributor wire firewall grommet installs in the firewall just above the ballast resistor. The wire from the under dash to the distributor goes here.



1955-57	#822	\$5.95/ea.
---------------	------------	------------

FIREWALL CABLE GROMMETS

You will need one of these for 1956 models and two for 1957. On 1956 it mounts in the firewall on the driver side between the column and inner fender and the speedo cable runs through it. Mounts higher on the 1957 on the driver side and passenger side and it is used for the heater cables.



#092

1956-57 Best	#092	\$6.95/ea.
1956-57 Good	#16691	\$3.50/ea.

HOOD BUMPERS

Four bumpers are needed for '55-'56 models; the 1957 model requires two. Sold in pairs.



1955-72	#222	\$1.95/pr.
---------------	------------	------------

1957 SPEEDOMETER CABLE GROMMET

This grommet mounts in a hole in the firewall on the driver side at the top of the toe board, next to the steering column. The speedometer cable runs through it to the inside of the car where it connects to the speedo in the instrument cluster.



1957	#823	\$4.95/ea.
------------	------------	------------

COWL VENT GROMMETS

The install in the cowl area on top of the firewall and keep the cowl vent from rattling.



1955-56 #234..... \$6.95/set

COWL TOP OUTER CORNER RUBBER BUMPERS

These grommets plug two holes in the outer cowl top, keeping water out of the cowl vent area.



1955-57 #801..... \$6.95/pr.



1957 REAR OF HOOD BRACE BOLT (NEAR COWL)

1957..... #2894..... \$3.95/ea.

SPARE TIRE WELL PLUG

These are the plugs used in the bottom of the spare tire well. You can also use them in the ends of the rocker panels.



1955-57 #825..... \$3.95/ea.

FRONT FENDER ANTENNA PLUG

For cars that do not have antennas, this plug seals the hole in the body inside the fender.



1955-57 #804..... \$4.95/ea.

1955 STARTER HARNESS (EARLY) AND CONVERTIBLE TOP MOTOR HARNESS GROMMET

This grommet fits up in the firewall behind the battery for the starter harness on early 1955's, and the convertible top power wire passes through this grommet before it connects to the convertible top switch.



1955 Best #915..... \$6.95/ea.
1955 Good #16720..... \$2.95/ea.

BALLAST RESISTOR COVERS



These little beauties are actually made out of stainless steel with a mirror bright finish that mates perfectly with our other chrome products. **Made in the USA.**

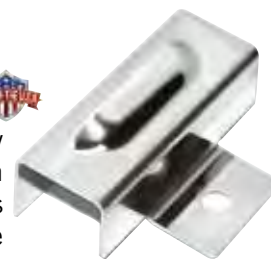

1955-57 Louvered #2510..... \$25.95/ea.



1957 POLISHED STAINLESS COWL BRACE COVER WITH CAP NUTS

Made in the USA.

1957..... #10562..... \$19.95/set



COWL VENT SCREWS

1955-56 #11948..... \$2.95/set



FENDER TO COWL BRACKET WASHERS

1955-57 #18024..... \$3.50/pr.

COWL TAG RIVETS

Why use standard "pop rivets" or sheet metal screws when you now can get the correct tag rivets. For use on all GM models.



1955-75 #2687..... \$8.95/pr.



HOOD HINGES

HOOD HINGES

Replace those worn, loose hinges with new ones. These hinges are designed to have the look, function and fit of the original. To complete the job, use with our hood springs, part #475, #476 or #477 shown on page 288.

- 1955-56 #1216.....\$169.95/pr.
- 1957..... #12223.....\$169.95/pr.

POLISHED STAINLESS HOOD HINGES

- 1955-56 #12380.....\$399.95/pr.
- 1957..... #12381.....\$389.95/pr.



1957 STEEL HOOD HINGES 

Replace those worn, loose hinges with new ones. These hinges are designed to have look, function and fit of the originals.

- 1957 Driver..... #16131.....\$89.95/ea.
- 1957 Passenger #16132.....\$89.95/ea.



BILLET SPECIALTIES HOOD HINGES

Now with springs included these Billet Specialties' precision machined, straight razor style hood hinges not only upgrade the hardware under your hood but look good while doing it! Manufactured from 6061-T6 billet they feature precision sealed bearings for smooth operation and come complete with stainless mounting hardware.

- 1955-56 Polished..... #19308.....\$669.95/pr.
- 1955-56 Black Anodized #19309.....\$699.95/pr.
- 1955-56 Machined..... #19310.....\$599.95/pr.

BILLET SPECIALTIES HOOD HINGE HD GAS SPRINGS

- All Polished, 350-lbs/in. #17797.....\$189.95/pr.



RING BROTHERS BILLET FRONT ADJUSTABLE HOOD STOPS

Designed to match their hood hinges, these hood stops are just the compliment you need under your hood. Sorry, 1955-56 rear adjusters are not available in billet. Available in natural, black and gray finishes.



- 1955-57 Natural..... #16469.....\$74.95/pr.
- 1955-57 Black..... #16470.....\$74.95/pr.

HOOD HINGES



#16247

EDDIE MOTORSPORTS BILLET HOOD HINGES

These billet hood hinges by Eddie Motorsports are exactly what you need to finish off the engine compartment of your classic. CNC machined from 6061-T6 billet they utilize a sealed bearing for ultra smooth operation and a stainless steel gas spring to complete the look.

1955-56 Machined	#16244	\$640.95/pr.
1955-56 Polished	#16245	\$695.95/pr.
1957 Machined	#16247	\$640.95/pr.
1957 Polished	#16248	\$695.95/pr.



EDDIE MOTORSPORTS BILLET TRUNK HINGES

These billet trunk hinges match the Eddie Motorsports hood hinges and add a custom touch to an often-overlooked area. Billet hinges replace the stock torsion bar with a modern gas spring mounted on each hinge for smooth operation. Complete with mounting hardware and instructions. For convertible applications just switch the hinges and mount the gas spring to the wheel well.

1955-57 Machined, Hardtop & Convertible	#16496	\$340.95/pr.
1955-57 Polished, Hardtop & Convertible	#16497	\$370.95/pr.
1955-57 Machined, Sedan	#16498	\$352.95/pr.
1955-57 Polished, Sedan	#16499	\$370.95/pr.



#16632

#16633

#16636

EDDIE MOTORSPORTS BILLET HOOD BRACES O/S

These billet aluminum hood braces replace the stamped steel baffle and include stainless hardware.

1955 Machined	#16632	\$177.95/ea.
1956 Machined	#16633	\$177.95/ea.
1957 Machined	#16634	\$177.95/ea.
1955 Polished	#16635	\$201.95/ea.
1956 Polished	#16636	\$201.95/ea.
1957 Polished	#16637	\$201.95/ea.



#16663

EDDIE MOTORSPORTS BILLET HOOD BRACE SUPPORTS O/S

#16668

These billet brace supports give you that finishing touch to your engine compartment to an area that is usually overlooked. Available in either machined or polished. Designed for use with EMS billet hood braces.

1955 Machined	#16663	\$114.95/pr.
1955 Polished	#16664	\$128.95/pr.
1956 Machined	#16665	\$114.95/pr.
1956 Polished	#16666	\$128.95/pr.
1957 Machined	#16667	\$114.95/pr.
1957 Polished	#16668	\$128.95/pr.



1955 HOOD BAFFLE BRACE O/S

This hood baffle brace supports the center hood baffle.

1955	#16214	\$88.95/ea.
-------------------	---------------------	--------------------



1955 HOOD BRACE RODS

Rivets for these are not longer being produced. Install with a nut and bolt.

1955 Driver.....	#1902.....	\$20.95/ea.
1955 Passenger.....	#1903.....	\$20.95/ea.



1957 HOOD REINFORCEMENT BRACE

1957 Center.....	#15312.....	\$74.95/ea.
------------------	-------------	-------------

HOOD RELATED



1957 HOOD BAFFLE BRACE



1957.....	#15215.....	\$89.95/ea.
-----------	-------------	-------------



1957 CUSTOM HOOD BAFFLE BRACE



Allows use of 1955-56 center outlet 6-cylinder radiators. Ideal for long water pumps or big block applications.

1957.....	#18304.....	\$94.95/ea.
-----------	-------------	-------------



HOOD SPRINGS



We have made every effort possible to manufacture an original looking and long wearing hood spring for your classic, dipped black like original to give you that showroom fresh look. Sold separately, but best purchased in pairs for even spring tension. **Made in the USA.**

1955 & 1955-57 Truck.....	#475.....	\$14.95/ea.
1956.....	#476.....	\$14.95/ea.
1957.....	#477.....	\$14.95/ea.



POLISHED STAINLESS HOOD SPRINGS

Built to the same specs as the originals, but made of polished stainless steel to add some shine.

1955.....	#17613.....	\$99.95/pr.
1956.....	#17614.....	\$99.95/pr.
1957 (Shown).....	#17615.....	\$109.95/pr.

HOOD STOP BOLTS

This is the bolt that supports the rubber hood bumper #222 shown on next page. See parts #1034/#1035 for complete kits.



1955-70 Front.....	#1030.....	\$1.95/ea.
1955-56 at Cowl.....	#1031.....	\$2.25/ea.



ADJUSTABLE HOOD STOP KITS

This complete assembly will quiet that hood rattle and help to align the seams. Nuts and bolts are cad plated.

1955-56.....	#1035.....	\$12.95/set
1957.....	#1034.....	\$6.95/set



SELF-LOCKING HOOD AND TRUNK PROP RODS

Lokar's self-locking adjustable prop rods are made of aluminum and stainless steel. Six level versions open in 6-inch increments while the 3 level versions open in 12-inch increments. Made for universal applications.

- All Polished, Adj Level, 3 Level #14548..... \$99.95/set
- All Polished, Adj Level, 6 Level #14549..... \$99.95/set



HOOD HINGE HARDWARE KITS

- 1955-56 Stainless..... #2881.....\$21.95/kit
- 1957 Stainless..... #2879.....\$21.95/kit
- 1955-56 Plated..... #2882.....\$19.95/kit
- 1957 Plated..... #2880.....\$19.95/kit



HOOD HINGE WASHERS

- 1955-56 Set of 8..... #18020..... \$8.95/set
- 1957 Set of 10..... #18021..... \$10.95/set



STAINLESS HOOD HINGE BOLT KIT

- 1955-57 w/ Bowtie..... #14278.....\$19.95/kit

HOOD HINGE TO HOOD BOLTS

When replacing your hood or hood hinges be sure to use new hardware. This set includes stainless steel washers, steel bolts, plated to resist corrosion.



- 1955-57 #2260..... \$7.95/set



HOOD SIDE BUMPERS

These important bumpers, located on either side of the hood, help to keep the hood properly aligned and in place. **Made in the USA.**

- 1955..... #225..... \$10.95/set
- 1956-57 #226.....\$7.95/pr.

1957 HOOD HINGE TO FENDER BRACKETS AND BOLTS

Replace those rusted, pitted, or lost hood hinge brackets. The 1957 hood hinge needs this fastener to stay properly secured to the fender.



- 1957..... #1480..... \$11.95/set

HOOD BUMPERS

Four bumpers are needed for '55-'56 models; the 1957 model requires two. Sold in pairs.

- 1955-72 #222.....\$1.95/pr.



1957 HOOD BRACE SCREWS

- 1957.... #2893.....\$3.95/pr.



1957 HOOD RADIUS ROD WASHERS

- 1957.... #18023....\$3.50/pr.

WARNING! Products on these pages may contain chemicals known to the State Of California to cause cancer and/or birth defects or reproductive harm. www.p65warnings.ca.gov

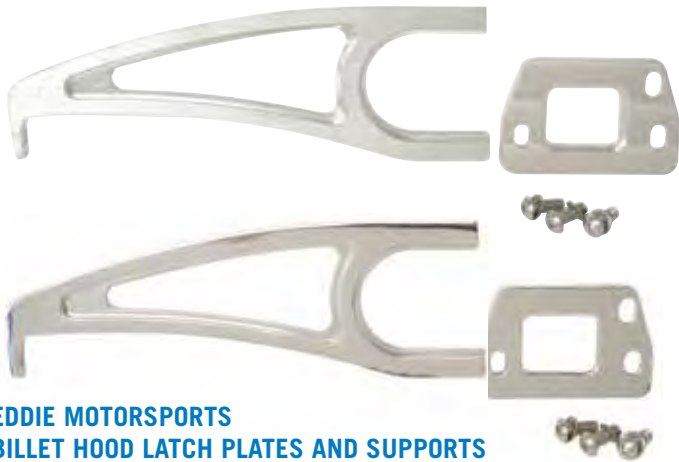

**EDDIE MOTORSPORTS
BILLET HOOD LATCH PLATES AND SUPPORTS**

HOOD RELATED This beautifully crafted billet latch plate and support match the EMS hood braces and supports, but is a stand out on its own. Machined or polished, either way it is sure to add that custom touch under the hood of your classic.

1955 Machined	#16669.....	\$138.95/set
1955 Polished.....	#16670.....	\$160.95/set
1956 Machined.....	#16671.....	\$143.95/set
1956 Polished.....	#16672.....	\$160.95/set
1957 Machined.....	#16673.....	\$160.95/set
1957 Polished.....	#16674.....	\$184.95/set



HOOD LATCH ASSEMBLIES

Latches come with required springs and are gold cad plated (originals were silver). Be sure to order hood latch screw set #2900, at left below, to complete the job.

1955	#14943.....	\$79.95/ea.
1956.....	#15896.....	\$79.95/ea.
1957.....	#15897.....	\$79.95/ea.



HOOD LATCH SUPPORTS

1955.....	#1147.....	\$24.95/ea.
1956.....	#14972.....	\$26.95/ea.
1957.....	#1149.....	\$24.95/ea.



BILLET STAINLESS HOOD LATCH STRIKER

1955-57 with Screws	#18988.....	\$159.95ea.
---------------------------	-------------	-------------



HOOD LATCH SCREWS

1955-57	#2900.....	\$8.95/set
---------------	------------	------------

**POLISHED
HOOD LATCH PLATE**

This polished aluminum, shorter length, latch plate gives you an extra 1/2-inch clearance for your A/C condenser.



1955-57 Short.....	#13788.....	\$67.95/ea.
--------------------	-------------	-------------



HOOD LATCH PLATES

1955-57 Chrome	#18033.....	\$29.95/ea.
1955-57	#1150.....	\$13.95/ea.



HORN ASSEMBLIES

These brand new horns are accurately reproduced to match the originals. They even have the AC-Delco logo molded into them. Sold in pairs.

- 1955-56 #18457 \$159.95/pr.
- 1957..... #18458..... \$159.95/pr.



HORN COVERS

For those who are restoring their original horns. Here are some beautiful repros to replace damaged or missing originals. Available in black or chrome.

- 1955-56 Black..... #17690..... \$16.95/ea.
- 1955-56 Chrome #17691..... \$23.95/ea.



HORN RELAYS

- 1955-56 #111..... \$20.95/ea.
- 1957..... #112..... \$19.95/ea.



REPLACEMENT HORNS

- 1955-57 High Note..... #11303..... \$20.95/ea.
- 1955-57 Low Note..... #11304..... \$22.95/ea.



INNER FENDER WIRE HARNESS CLIPS

Made in the USA.

- 1955-57 #1006..... \$49.95/set

HOOD LATCH SPRING SET

As springs age they lose their tension; fatigued springs may not hold the hood securely in place. You can solve this problem easily by installing a new hood latch spring set. When you replace these parts you may need to replace the hood latch plate and support; both shown at left.

- 1955-57 #2184..... \$19.95/set



HORN POST INSULATORS

- 1955-56 #14969..... \$8.95/pr.

1957 HORN WIRE TO INNER FENDER CLIPS

These clips keep the horn wire in place on the radiator core support filler panels.

- 1957..... #1485..... \$11.95/pr.



VALVE COVERS



#17189



#17190



#17185

PML FINNED ALUMINUM VALVE COVERS WITH "CHEVROLET" SCRIPTS

These sand cast aluminum valve covers feature raised "Chevrolet" script lettering and seven fins. These valve covers feature cast-in baffling and a mid-height design that will clear most roller and/or ratio rockers. All of these covers feature thick side walls and gasket flanges that will not bend when bolts are tightened, cast-in internal baffles (1960-86 version). The 1955-59 valve covers do not have a provision for PCV, breather or oil fill because the original valve covers did not have a provision for PCV, breather or oil fill. This was done in the intake manifold. The 1955-59 versions have staggered bolt holes for 1955 to early 1959 cylinder heads. Parts #17188, 17189 and 17190 are available machined with PCV and breather holes by special order. All these PML valve covers are also available in black by special order.

1955-59 Cast.....	#17185.....	\$274.95/pr.
1955-59 Orange.....	#17186.....	\$434.95/pr.
1955-59 Polish.....	#17187.....	\$549.95/pr.
Late 59-86 Cast.....	#17188.....	\$274.95/pr.
Late 59-86 Orange.....	#17189.....	\$449.95/pr.
Late 59-86 Polished.....	#17190.....	\$549.95/pr.



#15005



#15004



#15007

EDELBROCK CLASSIC FINNED VALVE COVERS

They were an instant classic in the 50's and are still today. They're available with or without breather holes and are available in polished or classic black. Be sure to order a matching air cleaner.

1959-86 Polished, SB w/ Breather Hole

..... #15004..... \$256.95/ea.

1959-86 Black, SB..... #15005..... \$242.95/ea.

1959-86 Black, SB w/ Breather Hole

..... #15006..... \$274.95/ea.

1965-Up Black, BB 396/502..... #15007..... \$256.95/ea.



#1932

VALVE COVERS FOR SMALL BLOCKS

Made of heavy-gauge steel, these covers are at least 20% thicker than typical aftermarket valve covers. Leakage problems caused by over-torqued fasteners are eliminated. Beautiful chrome plating meets GM quality specifications, and all covers bear the bowtie logo. For use on late 1959-86 Chevy small blocks. Include the PCV baffle for those who wish to maintain the PCV hook-up. **Technical Note:** Production height valve covers and valve covers with baffles will not clear most stud girdle applications. All valve covers are sold in pairs and are equipped with air breather and PCV grommets, unless otherwise specified. These valve covers are not for use with staggered heads, nor are they legal for sale or use in California on pollution controlled vehicles. Gaskets and hardware not included.

1959-86 Short Cover w/ Baffle..... #1931..... \$69.95/pr.

1959-86 Tall Cover w/ Baffle..... #1932..... \$84.95/pr.



AVS SPEEDCOVER LS ENGINE COVERS

The AVS Speedcover kits leaves nothing to the imagination in LS Performance styling! **Made in the USA** from a high temperature resistant automotive poly carbonate and featuring 6061 billet aluminum cover inserts. This kit is compatible with any automotive paint or hydro dipping for endless customizing capabilities! AVS engineered the LS1 Speedcover kit to fit LS1, 2, 3 passenger car intakes and coil packs only. Kit includes: valve covers, intake cover, cover inserts, ARP mounting hardware, billet aluminum oil filter and aluminum cylinder stand offs. Please note: some trimming required depending on accessory configuration. Must install aftermarket fuel rails, Holley part #534-210 recommended.

- All LS1, w/ Oval Inserts #19282..... \$899.95/kit.
- All LS2/LS3, w/ Oval Inserts..... #19283..... \$949.95/kit.



AVS SPEEDCOVER LS COVER INSERTS

- All Valve Cover Inserts, LS1 #19284..... \$74.95/pr.
- All Valve Cover Inserts, LS2 #19285..... \$74.95/pr.
- All Valve Cover Inserts, LS3 #19286..... \$74.95/pr.
- All Valve Cover Inserts, LS Perform#19287..... \$74.95/pr.

NOTE ON AFTERMARKET VALVE COVERS:

Most aftermarket valve covers do not fit heads with a staggered bolt pattern, and will not fit 1955-early 1959 original V8's. All valve covers listed on page 292-296 are considered aftermarket valve covers, except #17185, #17186 and #17187 which have staggered holes.



Photo courtesy of GERTMAN2000



PML SMALL BLOCK ALUMINUM VALVE COVERS WITH "CHEVROLET" SCRIPT

Parts are available machined with PCV and breather holes by special order. All these PML valve covers are also available in black by special order.

- 1959-86 Cast..... #18158.....\$274.95/pr.
- 1959-86 Polished..... #18159.....\$499.95/pr.
- 1959-86 Orange..... #18160.....\$449.95/pr.



BILLET SPECIALTIES BALL MILL VALVE COVERS

- 1959-86 SB, Short..... #17079.....\$119.95/pr.
- 1959-86 SB, Tall..... #17080.....\$119.95/pr.
- All BB, Short..... #17086.....\$199.95/pr.
- All BB, Tall..... #17087.....\$199.95/pr.



BILLET SPECIALTIES STREAMLINE VALVE COVERS

Billet Specialties Streamline valve covers offer a fresh new look for your classic Chevy. Precision machined billet single raised rib on a cast aluminum valve cover compliments any exterior cue. See page 327 for matching air cleaner.

- 1959-86 SB, Black..... #17792.....\$279.95/pr.



BILLET SPECIALTIES RIBBED VALVE COVERS

- 1959-86 SB, Tall..... #17078.....\$219.95/pr.



BILLET SPECIALTIES "CHEVROLET" VALVE COVERS

- 1959-86 SB, Short..... #17081.....\$164.95/pr.
- 1959-86 SB, Tall..... #17082.....\$156.95/pr.
- All BB, Tall..... #17085.....\$199.95/pr.



PROFORM HIGH TECH SERIES DRESS-UP KITS

Give your engine a truly unique and striking look. These stamped steel bolt-on dress-up parts are available in either high-tech metallic gray, black crinkle (shown on page 296) or chrome and are finished off with bowtie and "Chevrolet" emblems. Each kit includes: late 1959-86 valve covers, air cleaner, timing chain cover, breather cap, wing nuts and hold-down clamps.

1959-86 SB, Gray.....	#13824.....	\$261.95/kit
1959-86 SB, Chrome	#13825.....	\$266.95/kit



SMALL BLOCK CHEVY ENGINE DRESS-UP KIT

Chevy orange valve covers, with their distinctive look and boldly striking bowtie and "CHEVROLET" emblems, inlaid with black paint. For long-term corrosion resistance the parts are electrostatically painted and baked with a durable orange epoxy. The kits include a pair of tall baffled bowtie valve covers, a 14-inch classic bowtie air cleaner kit, a bowtie timing chain cover, eight bowtie valve cover mini nuts, eight bowtie valve cover hold-down clamps, and a matching bowtie push-in valve cover breather cap.

1959-86	#16906.....	\$261.95/kit
1959-86 SB, Valve Covers Only, Tall.....	#16907.....	\$87.95/ea.
1959-86 14" Air Cleaner Only	#16908.....	\$86.95/ea.



BLACK CRINKLE ENGINE DRESS-UP KIT

This engine dress-up kit from Proform is first CED painted for long term corrosion resistance and then over-painted in nostalgic crinkle black. The boldly striking bowtie and the "Chevrolet" emblems are inlaid with red. Kit includes: one pair of tall baffled valve covers, 14-inch air cleaner kit, timing chain cover, eight wing nuts, eight bowtie valve cover hold-down clamps and a matching push-in valve cover breather cap.

- 1959-86 Black Crinkle, Tall, SB #13826..... \$261.95/kit
- 1959-86 Black Crinkle, Tall, SB, Valve Covers Only..... #13828..... \$89.95/kit



PROFORM VALVE COVER WING NUTS

All Black Crinkle..... #13831..... \$24.95/set



#18236

ARP STAINLESS VALVE COVER BOLTS

- All Hex Head, SB w/ Cast Aluminum Covers #14023..... \$24.95/set
- All 12-Point Head, SB w/ Cast Alum. Covers (Shown) #14024..... \$28.95/set
- All Hex Head, SB w/ Steel Covers #14025..... \$24.95/set
- All 12-Pt. Head, SB w/ Steel Covers #14026..... \$26.95/set
- All Hex Head, BB w/ Cast Aluminum Covers #14027..... \$41.95/set
- All 12-Pt. Head, BB w/ Cast Alum. Covers #14028..... \$47.95/set
- All Hex Head, BB w/ Steel Covers #14029..... \$39.95/set
- All 12-Pt. Head, BB w/ Steel Covers #14030..... \$43.95/set
- All Hex, LS #18236..... \$74.95/kit
- All 12-Pt, LS..... #18237..... \$79.95/kit



VALVE COVER SCREWS AND WASHERS

This is the only way to properly mount your original valve covers. Screws and washers have a bright cad plate finish.
1955-57 #1163..... \$9.95/set



"CHEVROLET" VALVE COVER STENCIL



Without this kit, painting your valve covers can be a painstaking process. Restore that factory look to your engine compartment. Includes two adhesive-backed stencils per kit. **Made in the USA.**

- 1955-57 V8 #932..... \$14.95/kit

VALVE COVER FASTENERS

The distinct bowtie logo is featured on each wing nut. Shafts have a wide base for a broad load distribution. Each nut is supplied with a separate stud for proper positioning of the valve cover gasket prior to mounting of the valve cover. Fasteners fit both small and big block. 1/4-inch 20 threads; Four per package.



All..... #1933..... \$24.95/set



6-CYLINDER GASKET SETS

1955-57 Valve Cover..... #18132..... \$10.95/set
 1955-57 Pushrod Cover..... #18133..... \$9.95/ea.



SMALL BLOCK VALVE COVER GASKET

Two required per car. Genuine GM.
 1955-72 Cork..... #11193..... \$14.95/ea.



BIG BLOCK VALVE COVER GASKETS

All Cork..... #17346..... \$13.95/pr.

PCV VALVE CONVERSION KIT

Designed for 265 and 283 c.i. motors with factory draft tubes. A common complaint of 5-6-7 owners are fumes coming from the draft tube. The PCV kit is designed to route those fumes back into the motor and burn them.



1956-57 #13282..... \$42.95/kit



BILLET SPECIALTIES HEX VALVE COVER HOLD-DOWNS

All 4-Pack..... #17083..... \$27.95/set



BILLET SPECIALTIES VALVE COVER LONG STUD KIT

All 4-Pack..... #17084..... \$6.95/kit

VALVE COVER HOLD-DOWN CLAMPS

By spreading the load over a wider area, these clamps minimize distortion of the valve cover flanges, decreasing the possibility of oil leakage.



Fits all small block engines through 1986. Sold separately.

1955-86 #1934..... \$1.95/ea.

VALVE COVER AIR CLEANER BRACES

These braces help support the dual 4-barrel batwing air cleaner assembly and mounts between the valve covers and the air cleaner pots.



1956 Dual 4BC..... #15536..... \$17.95/pr.

1957 Dual 4BC..... #15537..... \$17.95/pr.

VENTED OIL CAP

A stainless version of the high performance V8 oil cap (Part #1290). It features OIL markings stamped in beautiful stainless steel. Vented with filter. **Made in the USA.**



1955-64 Polished Stainless #18972..... \$29.95/ea.

HIGH PERFORMANCE OIL BREATHER CAP

Original equipment for high performance V8's, this hard-to-find cap features "OIL" markings stamped in beautiful, silver finished steel. Vented with filter.



1955-57 #1290..... \$33.50/ea.



#12485



#12491

BILLET BREATHER CAPS

All are push-in style. Use with part #1938 grommets shown below at right.

All Polished..... #12485..... \$25.95/ea.

All w/ PCV, Polished, Plain #12491..... \$31.95/ea.



VALVE COVER OIL FILLER CAP

This Billet Specialties push-in valve cover oil filler cap is precision machined from 6061-T6 billet aluminum and polished to a mirror finish. It features a knurled edge for a positive grip and will fit Billet Specialties brand valve covers or other valve covers with a 1-1/4-inch hole. **Made in the USA.**

All Push-In, 1-1/4" Hole #18597. \$32.95/ea.



TWIST-ON VALVE COVER BREATHER CAP

This twist-on cap utilizes two small metal tabs on its collar to keep it in place. For use with valve covers that have tab cutouts around the breather cap hole. Outside diameter is 3-inch. Features bowtie logo. **Technical Note:** Manufactured with non-asbestos gaskets. It may be necessary to remove one gasket for proper clearance.

All Chrome #1937... \$11.95/ea.



OIL FILLER BREATHER CAP

This is the authentic Chevy design cap used from 1955 to 1957. Painted black; includes raised "OIL" markings.

1955-57 V8 #995..... \$24.95/ea.



POLISHED BILLET OIL CAP

Use with valve covers with 1.22-inch holes. Use with part #1938 grommets shown at right.

All Plain, Push-In #12497. \$12.95/ea.

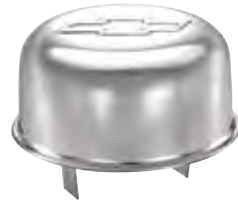

PUSH-ON VALVE COVER BREATHER CAP

This breather cap features the bowtie logo and 3-inch diameter. For use with oil filler tube #1981 or others with a 1.82-inch opening.

All..... #1935... \$12.95/ea.



PUSH-IN BREATHER CAP

This 3-inch diameter breather cap is for use with valve covers with grommets fitting 1.22-inch holes. Use with grommet from set #1938, shown below. Features bowtie logo.

All..... #1936... \$11.95/ea.



CHROME VALVE COVER BREATHER CAP

1987-93 #2482..... \$8.95/ea.



OIL FILLER BREATHER CAP

1955-57 Replacement, 6-Cyl. #18216... \$7.95/ea.



VALVE COVER BREATHER CAP GROMMETS

Includes a grommet for the breather cap and one for the PCV valve.

All..... #1938..... \$5.95/set



BILLET SPECIALTIES RETRO BREATHER CAPS

All Plain, Polished	#17578.....	\$59.95/ea.
All w/ PCV, Plain, Polished	#17579.....	\$59.95/ea.
All w/ Script, Polished.....	#17580.....	\$69.95/ea.
All w/ PCV, w/ Script Polished	#17581.....	\$69.95/ea.
All w/ Script, Black	#17582.....	\$69.95/ea.
All w/ PCV, w/ Script, Black.....	#17583.....	\$69.95/ea.



#17077

#17076

BILLET SPECIALTIES RIBBED, OVAL BREATHER CAPS

All PCV.....	#17077.....	\$59.95/ea.
All.....	#17076.....	\$54.95/ea.

#17101



#17099

BILLET SPECIALTIES POLISHED HOSE ENDS

For use with rubber or braided hoses.

All 3/8" Rubber	#17097.....	\$14.95/ea.
All 3/8" Braided	#17098.....	\$13.95/ea.
All 5/8" Rubber	#17099.....	\$16.95/ea.
All 5/8" Braided	#17100.....	\$16.95/ea.
All 1-1/2" Rubber	#17101.....	\$26.95/ea.
All 1-3/4" Rubber	#17102.....	\$26.95/ea.



BILLET SPECIALTIES BALL MILLED BREATHER CAPS

All.....	#17074.....	\$39.95/ea.
All PCV.....	#17075.....	\$39.95/ea.



BILLET SPECIALTIES BREATHER CAPS WITH BOWTIE

All.....	#17072.....	\$46.95/ea.
All PCV.....	#17073.....	\$46.95/ea.



**BILLET SPECIALTIES
PCV VALVE**

All Polished	#17071.....	\$33.95/ea.
--------------------	-------------	-------------

**BILLET ALUMINUM VALVE
COVER BREATHER CAP**

Matches Victor Series valve covers.

All Black	#14999.....	\$44.95/ea.
-----------------	-------------	-------------



For over a quarter century, Russell's full flow hoses and hose ends have been the choice of professionals. Whether it's the classic anodized finish, the stainless look of Endurashine, or the subtle look of the black ProClassic Series, Russell offers you the best hoses and fittings available anywhere. Russell fittings are interchangeable with many other manufacturers.



RUSSELL PERFORMANCE PROCLASSIC HOSES

Both the ProClassic and the ProClassic II series hoses are great choices. These hoses feature a lightweight nylon fiber outer braid over a durable rubber core with a maximum pressure rating of 350 psi. These are capable of handling nearly every plumbing task on your car and is safe to use with fuel, oil or antifreeze. -6AN is equivalent to 3/8" hose, -8AN is equivalent to 1/2" hose, -10AN is equivalent to 5/8" hose. Only difference between the two series is the II is solid black while the original ProClassic has a subtle blue thread woven in the nylon braid, shown above.

- All Black, 6AN, 6ft. #14525..... \$48.95/FT
- All Black, 8AN, 6ft. #14526..... \$49.95/FT
- All Black, 10AN, 6ft. #14527..... \$55.95/FT
- All Black, 6AN, 10ft. #14529..... \$69.95/FT
- All Black, 8AN, 10ft #14530..... \$79.95/FT
- All Black, 10AN, 10ft. #14531..... \$85.95/FT



HOSE ENDS

- All 4AN, Straight... #14326..... \$8.95/ea.
- All 6AN, Straight... #14327..... \$6.95/ea.
- All 8AN, Straight... #14328..... \$9.95/ea.
- All 10AN, Straight. #14329..... \$11.95/ea.
- All 4AN, 45°, #14331..... \$16.95/ea.
- All 6AN, 45°, #14332..... \$10.95/ea.
- All 8AN, 45°, #14333..... \$10.95/ea.
- All 10AN, 45°, #14334..... \$21.95/ea.
- All 4AN, 90°, #14336..... \$17.95/ea.
- All 6AN, 90°, #14337..... \$10.95/ea.
- All 8AN, 90°, #14338..... \$17.95/ea.
- All 10AN, 90°, #14339..... \$25.95/ea.



FLARE UNIONS

- All 6AN #14356..... \$3.95/ea.
- All 8AN #14357..... \$6.95/ea.
- All 10AN #14358..... \$6.95/ea.
- All 6AN, Black..... #14429..... \$4.95/ea.
- All 8AN, Black..... #14430..... \$7.95/ea.
- All 10AN, Black... #19330..... \$4.95/ea.

FLARE TEES

- All 6AN #14382..... \$13.95/ea.
- All 8AN #14383..... \$15.95/ea.



ADAPTERS

- All 4AN Flare to 1/8" NPT #14359..... \$3.95/ea.
- All 6AN Flare to 1/4" NPT #14360..... \$5.95/ea.
- All 6AN Flare to 1/8" NPT #14361..... \$4.95/ea.
- All 6AN Flare to 3/8" NPT #14362..... \$4.95/ea.
- All 8AN Flare to 1/4" NPT #14363..... \$4.95/ea.
- All 8AN Flare to 3/8" NPT #14364..... \$4.95/ea.
- All 8AN Flare to 1/2" NPT #14365..... \$4.95/ea.
- All 10AN Flare to 1/2" NPT #14366..... \$4.95/ea.



SWIVEL COUPLERS

- All 6AN, Straight... #14341..... \$9.95/ea.
- All 8AN, Straight... #14342..... \$12.95/ea.
- All 10AN, Straight. #14343..... \$17.95/ea.
- All 6AN, Black, Straight #14435..... \$11.95/ea.
- All 8AN, Black, Straight #14436..... \$13.95/ea.
- All 10AN, Black, Straight #14437..... \$17.95/ea.
- All 6AN, Endura, Straight #14475..... \$14.95/ea.
- All 8AN, Endura, Straight #14476..... \$16.95/ea.
- All -0AN, Endura, Straight #14477..... \$18.95/ea.



PROFLEX HOSES

ProFlex hoses are rated up to 1000 psi. Not for use as power steering pressure line.

- All 4AN, 6ft #14507..... \$38.95/ea.
- All 6AN, 6ft #14508..... \$39.95/ea.
- All 8AN, 6ft #14509..... \$39.95/ea.
- All 10AN, 6ft. #14510..... \$49.95/ea.
- All 4AN, 10ft. #14512..... \$63.95/ea.
- All 6AN, 10ft. #14513..... \$59.95/ea.
- All 8AN, 10ft. #14514..... \$73.95/ea.
- All 10AN, 10ft. #14515..... \$85.95/ea.



POWERFLEX HOSES

PowerFlex hose is rated 2500 psi and is recommended for power steering apps.

- All 6AN, 3ft. #14517..... \$17.95/ea.
- All 6AN, 6ft. #14519..... \$29.95/ea.



ELBOWS

- All 4AN x 1/8" NPT, 90° #14373..... \$11.95/ea.
- All 4AN x 1/4" NPT, 90° #14374..... \$9.95/ea.
- All 6AN x 1/4" NPT, 90° #14375..... \$12.95/ea.
- All 6AN x 1/8" NPT, 90° #14376..... \$9.95/ea.
- All 6AN x 3/8" NPT, 90° #14377..... \$12.95/ea.
- All 8AN x 1/4" NPT, 90° #14378..... \$16.95/ea.
- All 8AN x 3/8" NPT, 90° #14379..... \$10.95/ea.
- All 10AN x 1/2" NPT, 90° #14381..... \$17.95/ea.

ALLEN SOCKET PIPE PLUGS

- All 1/8" #14399..... \$3.95/ea.
- All 1/4" #14400..... \$3.95/ea.
- All 3/8" #14401..... \$3.95/ea.
- All 1/2" #14402..... \$3.50/ea.
- All 3/8", Black..... #14433..... \$4.95/ea.
- All 1/2", Black..... #14434..... \$3.95/ea.



RUSSELL PERFORMANCE ON THIS PAGE ARE NEW PRODUCTS AT DANCHUK!!

Under the Hood
RUSSELL FITTINGS



#19317

PROCLASSIC II BLACK HOSES

- All 6AN, 6ft #19311 \$41.95/ea.
- All 6AN, 10ft #19312 \$66.95/ea.
- All 6AN, 20ft #19313 \$129.95/ea.
- All 8AN, 6ft #19314 \$34.95/ea.
- All 8AN, 10ft #19315 \$51.95/ea.
- All 8AN, 20ft #19316 \$99.95/ea.
- All 10AN, 6ft #19317 \$41.95/ea.
- All 10AN, 10ft #19318 \$59.95/ea.



POWER STEERING HOSE ENDS IN STAINLESS

- All -6AN, Straight.. #14488 \$17.95/ea.
- All -8AN, Straight . #14489 \$19.95/ea.
- All -6AN, 45° #14490 \$24.95/ea.
- All -8AN, 45° #14491 \$19.95/ea.
- All -6AN, 90° #14492 \$22.95/ea.
- All -8AN, 90° #14493 \$27.95/ea.

BLACK SWIVEL HOSE COUPLERS

- All 6AN, Straight... #19340 \$7.95/ea.
- All 6AN, 90 Deg... #19341 \$9.95/ea.
- All 8AN, 90 Deg... #19342 \$20.95/ea.

BLACK FLARE CAPS

- All 6AN #19325 \$4.95/ea.
- All 8AN #19326 \$5.95/ea.

#19353



BLACK & SILVER O-RING BOSS FITTINGS

- 1955-57 ORB-6, 90deg, Black & Silver #19353 \$31.95/ea.
- 1955-57 ORB-8, 90deg, Black & Silver #19354 \$32.95/ea.
- 1955-57 ORB-10, 90deg, Black & Silver #19355 \$32.95/ea.

#19339



BLACK STRAIGHT ADAPTERS

- All 6AN to 1/8" NPT #19334 \$3.95/ea.
- All 6AN to 1/4" NPT #19335 \$5.99/ea.
- All 6AN to 3/8" NPT #19336 \$3.95/ea.
- All 8AN to 3/8" NPT #19337 \$3.95/ea.
- All 8AN to 1/2" NPT #19338 \$3.95/ea.
- All 10AN to 1/2" NPT #19339 \$3.95/ea.

BLACK TUBE SLEEVE

- 1955-57 8AN #19331 \$3.95/ea.

BLACK TUBE NUTS

- All 6AN #19332 \$3.95/ea.
- All 8AN #19333 \$5.95/ea.

#19349



BLACK FUEL PRESSURE TAKE OFF FITTINGS

- All 6AN w/ 1/8 Port#19349 \$10.95/ea.
- All 8AN w/ 1/8 Port#19350 \$8.95/ea.

#19351



BLACK FLARE TO PIPE PRESSURE ADAPTERS

- 1955-57 #19351 \$7.95/ea.
- 1955-57 #19352 \$8.95/ea.

#19320



BLACK SWIVEL HOSE ENDS

- All 6AN, 90 Deg... #19319 \$10.95/ea.
- All 8AN, 90 Deg... #19320 \$14.95/ea.
- All 10AN, 90 Deg.. #19321 \$17.95/ea.

BLACK HOSE ENDS

- All 6AN, 90 Deg ... #19322 \$10.95/ea.
- All 8AN, 90 Deg... #19323 \$14.95/ea.
- All 10AN, 90 Deg.. #19324 \$15.95/ea.



HOSE END WRENCHES

- All 6 AN #14495 \$28.95/ea.
- All 8 AN #14496 \$27.95/ea.
- All 10AN #14497 \$27.95/ea.



ADJUSTABLE -AN FITTING WRENCH

This wrench works with any brand -AN or hex fitting. Its billet aluminum construction helps in preventing marring or scratches.

- All..... #18515 \$55.95/ea.



HOSE AND FITTING ASSEMBLY LUBE AND SEALANT KIT

- All..... #14494 \$15.95/kit

INTERVERTED FLARE ADAPTERS

- All 6AN to 1/2-20 Female #19343 \$9.95/ea.
- All 6AN to 5/8-18 Female #19344 \$10.95/ea.
- All 8AN to 1/2-20 Female #19345 \$10.95/ea.
- All 8AN to 5/8-18 Female #19346 \$10.95/ea.

CARB/FUEL PUMP ADAPTERS

- All 6AN to 1/2-20 Male, Zinc #19347 \$6.95/ea.
- All 6AN to 5/8-18 Male, Zinc #19348 \$7.95/ea.

#19327



BLACK FUEL CELL BULKHEAD FITTINGS

- All 6AN (Shown) ... #19327 \$13.95/ea.
- All 8AN #19328 \$6.95/ea.
- All 10AN #19329 \$8.95/ea.

WARNING! Products on these pages may contain chemicals known to the State Of California to cause cancer and/or birth defects or reproductive harm. www.p65warnings.ca.gov



THERMO-TEC STARTER HEAT SHIELD

Eliminate starter problems caused by excessive heat with this easy to install starter heat shield kit. Kit includes heat shield and straps.

All 7" x 22" #13071 \$29.95/ea.



THERMO-TEC THERMOSLEEVES

ThermoSleeve combines high-temp fabric and a reflective foil that provides protection for hoses and wires. The sleeve is fireproof and oil resistant.

All 1/2" x 3-ft. #13066 \$14.95/ea.

All 1" x 3-ft. #13067 \$19.95/ea.

All 1-1/2" x 3-ft. #13068 \$19.95/ea.

THERMO-TEC THERMO-SHIELD

Use the adhesive backed Thermo-Shield to wrap hoses and wiring you don't want to remove but do want to protect from heat.

All 1-1/2" x 15-ft. Roll

..... #13065 \$18.95/ea.



THERMO-TEC EXPRESS SLEEVES

Express sleeves give you protection for hoses and wiring in an easy to install sleeve that closes with hook and loop closure and reflects up to 90% of radiant heat and are fireproof and oil-resistant.

All 3-ft. x 1-1/2" ID #15643 \$29.95/ea.

All 12-ft. x 1-1/2" ID #15644 \$104.95/ea.



THERMO-TEC ADHESIVE HEAT BARRIERS

Adhesive backed material can be wrapped around hoses or wires to make a clean professional appearance. Capable of withstanding radiant temps of up to 2000 degrees.

All 12" x 12" #13062 \$12.95/ea.

All 12" x 24" #13063 \$21.95/ea.

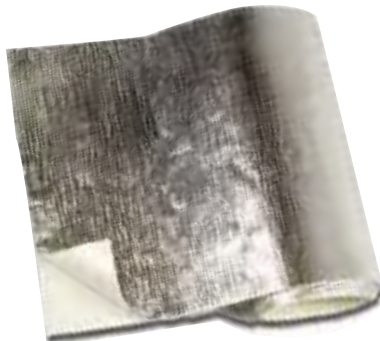

Photo courtesy of GERTMAN2000

7. Fuel & Exhaust

SECTION AT A GLANCE:

Gas Tanks	304
Gas Tank Related.....	307
Sending Units	310
Gas Lines.....	312
Fuel Pumps	313
Fuel Filter.....	314
Carburetor Related.....	315
Throttle Related	318
Intake Related.....	322
Linkage	324
Air Cleaners	326
Batwing Cleaners.....	328
Aeromotive.....	329
Intake Manifolds.....	334
Manifold & Carb Kits.....	336
Carburetors	338
Cylinder Heads.....	341
Edelbrock	342
Fuel Injection.....	346
Exhaust Systems	349, 353
Headers.....	350
Exhaust Manifold.....	354
Muffler & Tailpipe Hangers	357
Insulation	360



#2100



#16991



#10853

ORIGINAL DESIGN GAS TANKS O/S

Over 60 years of dirt, rust, and sludge are sitting at the bottom of that old gas tank. Running your tank dry could put that filth right where it hurts: in your engine. While cleaning the tank will solve the immediate problem, the real solution is these original design gas tanks. These tanks have all the correct details, including the threaded sending unit mount and mounting strap depressions.

1955-56 exc. Nomad, Wagon & Sedan Delivery, 16-Gallon, Best	#2099.....	\$239.95/ea.
1955-56 exc. Nomad, Wagon & Sedan Delivery, 16-Gallon, Good	#16991.....	\$199.95/ea.
1957 exc. Nomad, Wagon & Sedan Delivery, 16-Gallon, Best.....	#2100.....	\$239.95/ea.
1957 exc. Nomad, Wagon & Sedan Delivery, 16-Gallon, Good.....	#16992.....	\$199.95/ea.
1955-56 Wagon exc. 9-Passenger Wagon, 17-Gallon.....	#10853.....	\$249.95/ea.
1957 Wagon exc. 9-Passenger Wagon, 17-Gallon.....	#10854.....	\$249.95/ea.

STAINLESS STEEL GAS TANKS O/S

The quality construction of these 18-gallon capacity gas tanks is without equal. Fits all models except the Nomad, wagon and sedan delivery. Part #895A and #896A come with pre-installed TPI system compatible fuel pumps. TPI pump output is 45-55 PSI. Mounting straps are included, but you'll need to order a set of mounting bolts, part #1215, shown on page 307. Fuel sender for 0-30 OHM gauges. Now available for the LS engines. LS fuel pump output is 60-65 PSI at 55 gallons per hour.

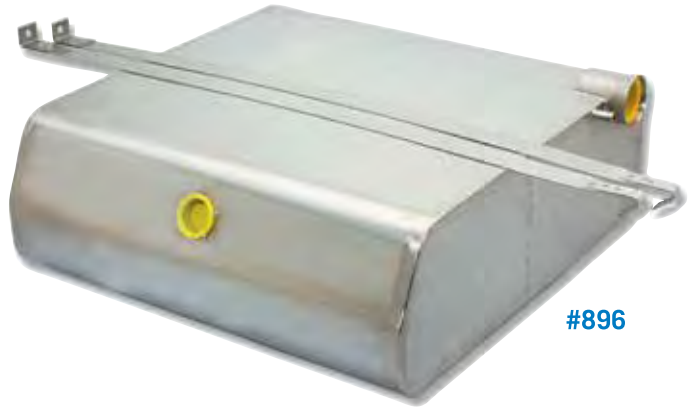

#896

1955-56 exc. Nomad, Wagon & Sedan Delivery	#895.....	\$859.95/ea.
1955-56 exc. Nomad, Wagon & Sedan Deliveryw/ TPI Unit	#895A.....	\$1179.95/ea.
1957 exc. Nomad, Wagon & Sedan Delivery (Shown)	#896.....	\$859.95/ea.
1957 exc. Nomad, Wagon & Sedan Delivery w/ TPI Unit	#896A.....	\$1179.95/ea.



HIGH CAPACITY GAS TANKS O/S

1955-57 25-Gallon, Aluminum	#19442.....	\$499.95/ea.	1955-57 25-Gallon, Black	#19444.....	\$699.95/ea.
1955-57 29-Gallon, Aluminum	#19443.....	\$499.95/ea.	1955-57 29-Gallon, Black	#19445.....	\$699.95/ea.



#19447

COMPLETE EFI GAS INSTALL KITS

1955-57 255 LPH.....	#19446.....	\$329.95/kit
1955-57 340 LPH (Shown)	#19447.....	\$399.95/kit

OE STYLE PERFORMANCE FUEL INJECTION GAS TANKS O/S

Factory style fuel injection gas tanks feature a factory spec sending unit and internal fuel pump that is rated at 85-115 PSI at 50-60 gallons per hour. Fuel pressure regulator required, but sold separately on page 344.

1955-56 exc. Wagon, 16-Gallon ..	#14947	\$699.95/ea.
1957 exc. Wagon, 16-Gallon.....	#14948.....	\$699.95/ea.



#14948

REPLACEMENT FUEL INJECTION FUEL MODULE

This is a complete replacement fuel module for the Danchuk #14947 and #14948 OE style performance fuel injection gas tanks. You get the hanger and sender assemblies along with the strainer, float and wiring harness. You will need a fuel pressure regulator to run this pump, sold separately.

1955-57	#18771	\$249.95/ea.
---------------	--------------	--------------

REPLACEMENT FUEL INJECTION FUEL PUMP

For tanks #14947 or #14948.

All.....	#17834.....	\$49.95/ea.
----------	-------------	-------------



AEROMOTIVE GEN II STEALTH GAS TANKS O/S

The Aeromotive Gen II Stealth tanks are the next generation of stealth tanks. They feature outlet and return ports along with electrical terminals positioned in the OEM location which allows for a flush installation to the vehicle floor and will not require strap modification or spacers. Just plug n' play.



Note: will not work on Nomads or wagons.
 1955-57 200LPH..... #19157..... \$498.95/ea.
 1955-57 340LPH..... #19158..... \$561.95/ea.

STAINLESS STEEL GAS TANKS WITH LS PUMP UNIT INSTALLED O/S

1955-56 w/ Straps..... #14253... \$1249.95/ea.
 1957 w/ Straps..... #14254... \$1295.95/ea.

GAS TANK MOUNTING STRAP BOLTS

This is a must-have item for those replacing their old gas tank or gas tank mounting straps. Includes nuts, bolts and washers.



1955-57 Best..... #1215..... \$6.95/pr.
 1955-57 Good..... #16804..... \$2.95/pr.



GAS TANK CENTERING KIT

The Williams Classic gas tank centering kit solves many issues you may run into while continuing your build. This kit gives you a nice symmetrical look for custom and stock style tanks and makes the routing of exhaust much easier. Requires installation of the Williams Classic Spare Tire Eliminator. For custom stainless tanks or fuel cells all that is required is a quick tracing of the side profile of your tank. Available in black, charcoal gray, silver, or bare steel. All required grade 8 hardware and gas tank filler nozzle weld-in extension is included. This kit is also useful for moving your tank back to clear a 4-bar setup.

1955-57 #15898 \$269.95/kit

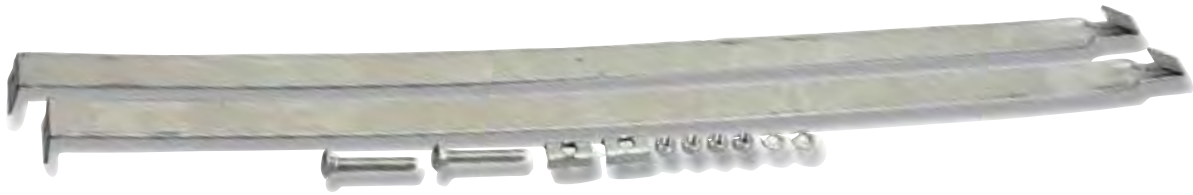

STAINLESS STEEL GAS TANK MOUNTING STRAPS WITH BOLTS

Replace those old rusty straps with our beautiful stainless ones.

1955-57 Hardtop, Sedan & Convertible #2752.....\$36.95/pr.



GAS TANK MOUNTING STRAPS

Remember to replace your gas tank mounting strap bolts # 1215 to finish the job. Fits hardtops, sedans and convertibles.

1955-57 #1214.....\$24.95/pr.



GAS TANK MOUNT  **O/S**

1955-57 Nomad & Wagon..... #12129.....\$194.95/ea.



GAS TANK LOCATOR KIT

This bracket mounts the front of the tank strap to the underside of the trunk floor.

1955-57 #12130..... \$49.95/set



#2885

GAS TANK MOUNTING STRAPS FOR NOMADS AND WAGONS

1955-57 Stainless..... #2885.....\$39.95/pr.
1955-57 Steel..... #2886.....\$41.95/pr.

GAS TANK RELATED



GAS TANK STRAP ANCHOR BRACKET KIT

This bracket welds to the rear of the trunk floor.
 1955-57 #11334.....\$41.95/kit

GAS TANK PIPE SUPPORT BRACKET

This bracket secures the gas tank filler pipe to the frame. It is used on 56 and 57 passenger cars and the 1956 9-passenger wagons only.



1956-57 #2617..... \$15.95/ea.

GAS TANK FILLER PIPE HOSE

This fuel transfer hose is constructed of heavy gauge neoprene and connects the upper and lower fuel tank filler hoses together.



1957 & 56-62 Vette #1296..... \$16.95/ea.

1956 GAS TANK TO BODY GROMMET



This "56 Only" grommet prevents the gas tank filler tube from rattling. Made of nitrile rubber to avoid damage from gas fumes. **Made in the USA.**



1956..... #1823..... \$17.95/ea.



GAS TANK FILLER TUBE "O" RING



Made in the USA.
 1955-57 #195A..... \$2.95/ea.



1957 GAS TANK FILLER PIPE HOSE AND CHECK VALVE KIT

Prevents splash back during acceleration. Can be installed in 55-56's by cutting the filler pipe.
 1957..... #14949..... \$44.95/kit



1957 GAS TANK FILLER PIPE AND VENT HOSE KIT

Contains the hard-to-find vent hose and clamps. The perfect addition to your gas tank restoration. **Made in the USA.**
 1957 ONLY #2645D..... \$49.95/kit



1957 GAS TANK FILLER PIPE HOSE CLAMPS

One pair needed per car.
 1957 Replacement #2643..... \$12.95/pr.

BRASS WIRE TIE

This brass wire tie is used to hold the '57 vent hose to the filler tube. It can also be used under the hood to hold bundles of wires together.



1955-57 #11209..... \$5.95/ea.



GAS TANK FILLER TUBES

Gas cap not included.

1955.....	#12739.....	\$75.95/ea.
1955 Nomad & Wagon.....	#12740.....	\$74.95/ea.
1956.....	#12741.....	\$94.95/ea.
1956 Nomad & Wagon.....	#12742.....	\$119.95/ea.
1957 Lower.....	#12642.....	\$69.95/ea.
1957 Upper.....	#12641.....	\$83.95/ea.
1957 Upper, Nomad & Wagon	#12744.....	\$92.95/ea.
1957 Lower, Nomad & Wagon	#12745.....	\$74.95/ea.

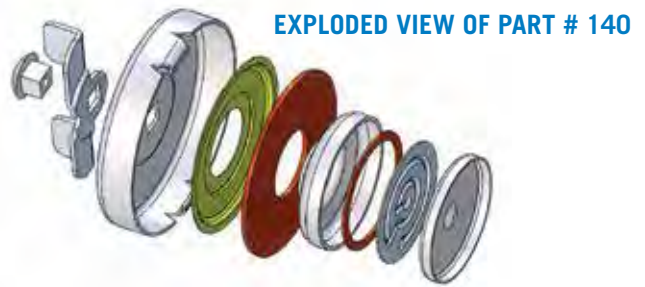

THE ORIGINAL GAS CAP

Our master toolmakers made sure that this gas cap was meticulously reproduced to match the original, including the complex venting system. This is a perfect reproduction **Made in the USA**. You will find none other that even comes close to being correct. Part #16694 is a basic replacement cap that does not have any of the features of part #140. **Made in the USA***.

1953-57 Best.....	#140*	\$18.95/ea.
1955-57 Good.....	#16694.....	\$6.95/ea.



"RED STRIPE" LOCKING GAS CAP

Protect your Chevy with this excellent reproduction gas cap. 1953-57 #139..... \$50.95/ea.



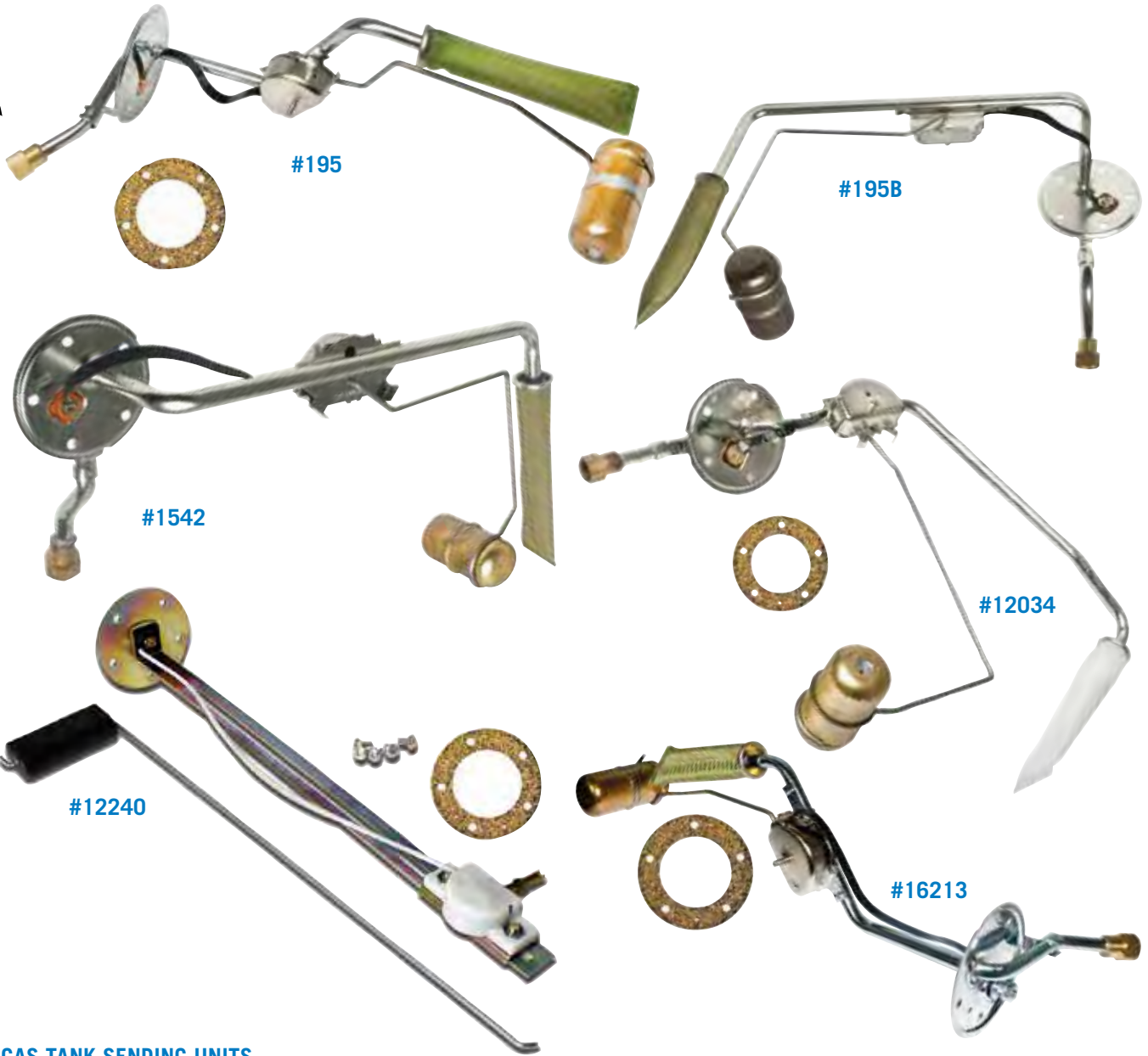

GAS TANK SENDING UNITS

All our senders are 0-30 OHM, like original, with the exception of 16213. Parts #1541 and #1542 are for high performance applications which use a 3/8-inch fuel line. Parts #19154, #19155 and #19156 are for fuel injection applications. It is for use with a 3/8-inch fuel line and it incorporates a 5/16" return line into the sending unit.

1955-57 Best, Hardtop, Sedan & Convertible, 5/16"	#195.....	\$62.95/ea.
1955-57 Good, Hardtop, Sedan & Convertible.....	#16696.....	\$42.95/ea.
1955-57 Best, Nomad & Wagon exc. 9-Passenger Wagon	#195B.....	\$64.95/ea.
1955-57 Good, Nomad & Wagon exc. 9-Passenger	#16697.....	\$49.95/ea.
1956 9-Passenger Wagon.....	#12034.....	\$64.95/ea.
1955-57 Dual 4BC, F.I., 3/8", exc. Wagon, Nomad & Sedan Delivery.....	#1541.....	\$64.95/ea.
1955-57 Dual 4BC, F.I., 3/8", 6-Passenger Wagon, Nomad & Sedan Delivery	#1542.....	\$64.95/ea.
1955-57 Universal Top Mount and TPI.....	#12240.....	\$64.95/ea.
1955-57 w/ Filter, 240-33 OHMS, 5/16", exc. Wagon	#16213.....	\$65.95/ea.
1955-57 exc. Wagon, HP, 3/8" w/ 5/16" Return Line.....	#19154.....	\$75.95/ea.
1955-57 9-Passenger Wagon, HP, 3/8" w/ 5/16" Return Line	#19155.....	\$59.95/ea.
1955-57 exc. 9-Passenger Wagon, HP, 3/8" w/ 5/16" Return Line	#19156.....	\$84.95/ea.



#195C



#195D

GAS TANK SENDING UNIT GASKETS

Anytime you remove the sending unit from the gas tank this gasket and the screws, #1488, should be replaced, whether you replace the sending unit or not. Part #195D is included with parts #195, #195B, #1541 and #1542 **Made in the USA.**

- 1955-57 Rubber..... #195C..... \$2.95/ea.
- 1955-57 Cork..... #195D..... \$3.95/ea.



CLASSIC INSTRUMENTS FUEL GAUGE INTERFACE

The FuelLink is a problem-solver that acts as an interface between fuel senders and gauges to correct ohm mis-match and erratic movement due to fuel slosh. In addition, an optional low fuel light trigger is available to trigger an indicator light at 1/8 of a tank.

- All..... #18365..... \$135.95/ea.



#1543

GAS TANK SENDING UNIT FILTERS

This often overlooked item should be replaced regularly. Moisture in the gas will eventually produce rust in the tank. Clogged filters result in poor performance. Remember to replace your gas tank sending unit gasket (#195D) and use a fresh screw set, (#1488) at the same time.

- 1955-57 Delco, 5/16" #1543..... \$9.95/ea.
- 1955-57 Delco, 3/8" #1544..... \$9.95/ea.
- 1955-57 5/16"..... #12696..... \$10.95/ea.
- 1955-57 3/8"..... #12697..... \$10.95/ea.

GAS TANK SENDING UNIT SCREW SET

When replacing the gas tank sending unit, this screw set is the only way to go. These screws have original 5/32" clutch heads and copper washers. **Made in the USA.**



- 1955-57 5/32" #1488..... \$5.95/set



#1538



#1539

GAS LINE HOSES

Located between the fuel pump and the steel gas line, this reinforced fuel hose has the correct fittings and dimensions to fit into an accurately restored engine compartment.

- 1955-57 2BC, 4BC, 5/16"..... #1538..... \$11.50/ea.
- 1956-57 Dual 4BC, F.I., 3/8" #1539..... \$19.95/ea.

GAS LINES AVAILABLE ON NEXT PAGE



GAS TANK SENDING UNIT FLOATS

- 1955-57 Best..... #11168..... \$10.95/ea.
- 1955-57 Good..... #16724..... \$8.95/ea.



SINGLE GAS LINE CLIP

Properly fasten the gas line with this original style clip. Includes mounting bolt.

- 1956-57 Dual 4BC, F.I., 3/8" #1527..... \$2.95/ea.

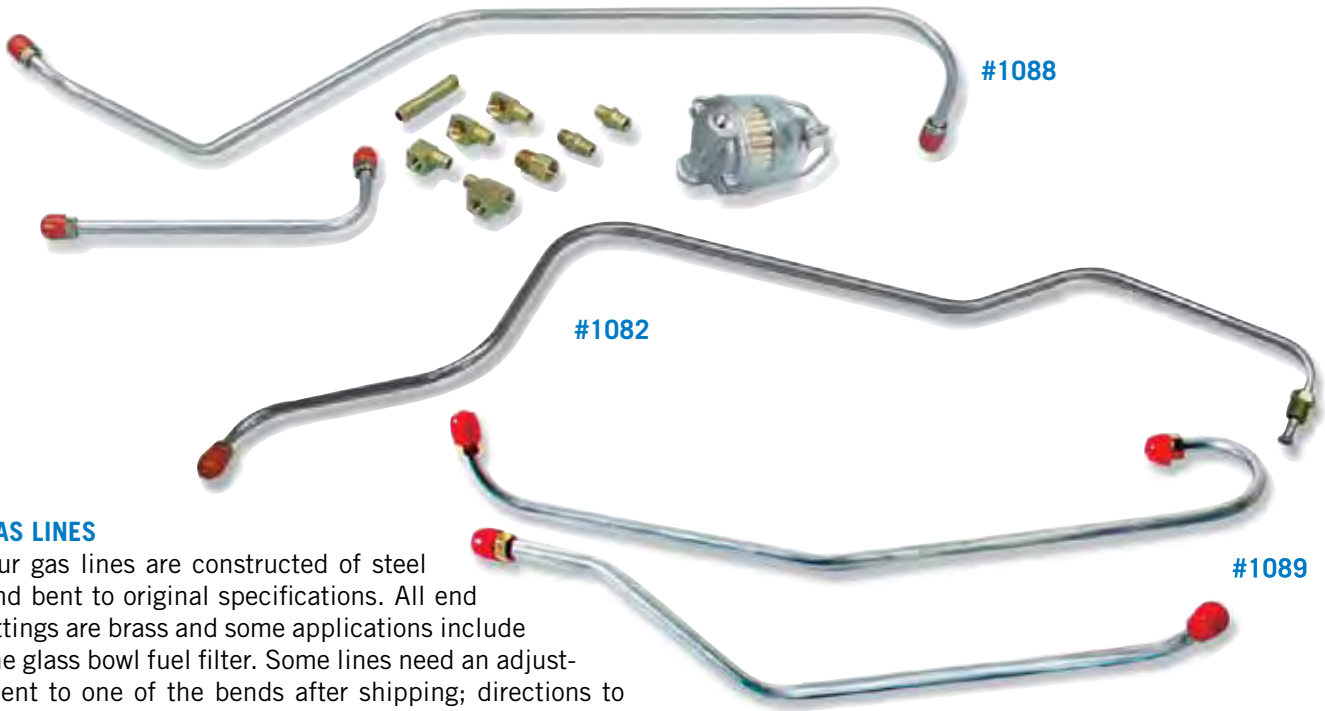

GAS LINES

Our gas lines are constructed of steel and bent to original specifications. All end fittings are brass and some applications include the glass bowl fuel filter. Some lines need an adjustment to one of the bends after shipping; directions to make the bend properly are included. It is important to note that our dual four barrel lines are the only ones that come with true reproduction brass fittings. Don't settle for cheap imitations when the best is here! Note: Glass bowl filters are included with #1085, #1087 and #1088.

1955-57 6-Cyl., Use w/ Fuel Filter, Filter Not Included.....	#1540.....	\$19.95/ea.
1955-57 6-Cyl., Use w/ Filter.....	#19142.....	\$18.95/ea.
1955-57 V8 Use w/ Carter, 4BC, w/o Filter.....	#19143.....	\$18.95/ea.
1955 V8 2BC, 4BC, Use with Fuel Filter, Filter Not Included, 1956 V8 2BC Use with Fuel Filter, Filter Not Included.....	#1555.....	\$18.95/ea.
1955 V8 2BC, 4BC 1/4" Line, Use without Filter, 1956 V8 2BC 1/4" Line, Use without Filter.....	#1082.....	\$35.95/ea.
1955 V8 2BC, 4BC w/ Original Add-On Oil Filter w/ Fuel Filter.....	#1083.....	\$19.95/ea.
1956-57 V8 2BC, 4BC w/o Fuel Filter, 5/16" Line.....	#1084.....	\$18.95/ea.
1956-57 V8 4BC w/ Fuel Filter, 5/16" Line, Filter Included.....	#1085.....	\$56.95/ea.
1956-57 V8 4BC, w/ GF 48 Filter.....	#19145.....	\$18.95/ea.
1956 Dual 4BC w/ Fuel Filter, Filter Included.....	#1087.....	\$82.95/kit
1957 V8 2BC w/ Fuel Filter, Filter Not Included.....	#1556.....	\$18.95/set
1957 Dual 4BC w/ Fuel Filter, Filter Included.....	#1088.....	\$82.95/set
1957 Fuel Injection Pump to Injector Line w/ Fittings.....	#1089.....	\$21.95/ea.
1957 V8 W/ Carter, 4BC, w/ Filter.....	#19144.....	\$18.95/ea.

FRAME GAS LINES PASSENGER CARS O/S

1955-57 6-Cyl., Inside Frame, 5/16".....	#1475.....	\$59.95/ea.
1955-57 6-Cyl., Convertible, Inside Frame, 5/16".....	#19137.....	\$59.95/ea.
1955-57 6-Cyl., Wagon, Inside Frame, 5/16".....	#19138.....	\$59.95/ea.
1955-57 2BC exc. Conv., Inside Frame, 5/16".....	#1476.....	\$64.95/ea.
1955-57 2BC Conv., Inside Frame, 5/16".....	#1477.....	\$59.95/ea.
1955-57 8-Cyl., 2BC Wagon, Inside Frame, 5/16".....	#19139.....	\$59.95/ea.
1955-57 4BC, Outside Frame, 5/16".....	#1478.....	\$74.95/ea.
1955-57 Dual 4BC, F.I., Outside Frame, 3/8".....	#1479.....	\$64.95/ea.
1955-57 V8 2BC, 5/16".....	#18122.....	\$53.95/ea.
1956-57 V8 4BC, Gas Line, Outside Frame, 5/16", 6-Passenger Wagons.....	#1595.....	\$64.95/ea.
1956 V8 Dual 4BC, 1957 V8 Dual 4BC or F. I., Outside Frame, 3/8", 6-Passenger Wagons.....	#1596.....	\$64.95/ea.

SEE PAGE 475 FOR NOTCHED LINE CLAMP KITS



STAINLESS STEEL FUEL AND BRAKE LINE CLAMPS

Single Clamps:

- 3/16", 12 pk. #12095..... \$19.95/set
- 1/4", 12 pk. #12096..... \$19.95/set
- 5/16", 12 pk. #12097..... \$19.95/set
- 3/8", 12 pk. #12098..... \$21.95/set
- 1/2", 12 pk. #12099..... \$19.95/set
- 5/8", 8 pk. #12100..... \$19.95/set
- 3/4", 8 pk. #12101..... \$19.95/set
- 7/8", 8 pk. #12102..... \$19.95/set

Double Clamps:

- 3/16", 6 pk. #12103..... \$19.95/set
- 1/4", 6 pk. #12104..... \$19.95/set
- 5/16", 6 pk. #12105..... \$19.95/set
- 3/8", 6 pk. #12106..... \$19.95/set
- 1/2", 6 pk. #12107..... \$19.95/set
- 5/8", 4 pk. #12108..... \$19.95/set
- 3/4", 4 pk. #12109..... \$19.95/set
- 7/8", 4 pk. #12110..... \$19.95/set

Combos:

- 3/16" x 3/8", 6 pk. #12111..... \$21.95/set
- 5/16" x 3/8", 6 pk. #12112..... \$19.95/set



REPLACEMENT FUEL PUMPS

These replacement fuel pumps will function like the originals with the proper fit and fuel pressure rating.

- 1955-57 6-Cyl..... #090..... \$79.95/ea.
- 1955-57 V8 #091..... \$74.95/ea.



FUEL PUMP BLOCK-OFF PLATE

Supplied with special non-asbestos gasket, this chrome plate is stamped with the popular Chevrolet bowtie logo.

- All SB..... #1957..... \$8.95/ea.



BILLET SPECIALTIES FUEL PUMP BLOCK-OFF PLATES

- All SB..... #17103..... \$21.95/ea.
- All BB..... #17104..... \$21.95/ea.



GAS AND BRAKE LINE FRAME CLIPS

- 1955-57 Inside Frame #1007..... \$29.95/set
- 1955-57 Outside Frame w/ Power Pack (Shown)
..... #1008..... \$35.95/set



ARP FUEL PUMP PUSHRODS

- All BB, Chrome Moly #14017. \$27.95/ea.
- All SB, Chrome Moly #14018. \$27.95/ea.

POLISHED BILLET FUEL PUMP BLOCK-OFF PLATE

- All BB ...#12484...\$9.95/ea.



ARP STAINLESS FUEL PUMP BOLTS

- All Hex..... #14009..... \$13.95/set
- All 12-Point..... #14010..... \$13.95/set



STAINLESS FUEL PUMP BOLT KIT

- All SB w/ Bowtie #14273....\$7.95/kit



1957 FUEL DOOR BOX INSIDE QUARTER PANEL
 1957 w/ Springs..... #16960..... \$55.95/ea.



1955 GAS DOOR FILLER BRACKET
 1955..... #2105..... \$48.95/ea.



GAS DOOR RUBBER BUMPERS
 1955..... #807..... \$5.50/set
 1957..... #808..... \$4.95/set



1957 GAS DOOR STOP KIT
 1957..... #14178..... \$6.50/kit



1957 GAS DOOR SCREW SETS
 1957..... #2180..... \$4.95/set
 1957 Stainless..... #15424..... \$4.95/set

#2104



#1090

GLASS BOWL FUEL FILTERS

Get rid of that cheap in-line filter and get the genuine article. Our #2104 filter is a reproduction of the original Chevy design, and includes correct AC markings. If you're restoring a driver, use our replacement glass bowl fuel filter, part #1090.

1955-57 4BC #2104..... \$34.95/ea.
 1956-57 4BC #1090..... \$34.95/ea.



ARP EDELBROCK/CARTER AFB FLOAT BOWL BOLT KIT

Replace the fragile torx head bolts with these beautiful 12-point stainless bolts from ARP.

All..... #18226..... \$19.95/kit

REPLACEMENT FUEL FILTER GLASS BOWL ONLY

This is the replacement glass bowl only for the Danchuk #2104 and #1090 fuel filter assemblies.

1955-57 w/ AC Markings #16839..... \$17.95/ea.



FUEL FILTER ELEMENT

Keep your fuel filter clean by replacing it regularly. This filter element fits our glass bowl fuel filter, part #2104, shown above, and is also used in gas line kits #1085, #1087 and #1088 shown on page 312.

1955-57 #1303..... \$5.95/ea.



1957 GAS DOOR SPRINGS

If your gas door is rattling then replacing the springs will make sure it stays tight when closed. Easy to replace.

1957..... #676..... \$6.95/pr.





CARBURETOR BRASS VENT TUBES

The carburetor vent tubes are an important part of a correct and complete 4 barrel carburetor restoration job. Set of 4, 2 front & 2 rear for 2 carbs.

1956-61 2 X 4BBL, Set of 4 #18942..... \$51.95/set



CARBURETOR METERING RODS AND JETS FOR DUAL 4-BARREL CARBURETORS

Worn metering rods will cause the air-fuel ratio to become too rich. These kits contain both the metering rods and jets for the Carter WCFB dual four barrel carburetors.

1957-61 WCFB 2626 & 2627 (Shown) #1840..... \$108.95/set
 1957-61 WCFB 2313 & 2314 #1841..... \$108.95/set

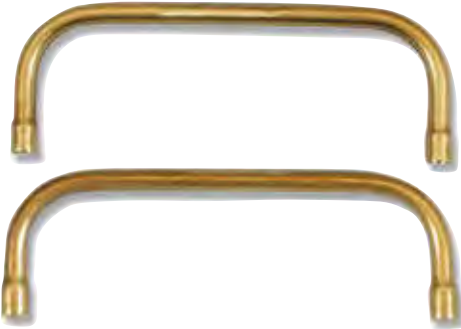

DUAL 4-BARREL CARBURETOR VENT TUBES

The carburetor vent tubes are an important part of a correct and complete 4-barrel carburetor restoration job. Two of each required per carburetor.

1956-57 Front of Carburetor..... #1102..... \$14.95/ea.
 1956-57 Rear of Carburetor #1101..... \$14.95/ea.

CARBURETOR MOUNTED LINKAGE BRACKETS

This is a chrome carburetor linkage bracket for used with either Holley, Edelbrock, Rochester Quadrajets or Carter carburetors. It mounts to the base of the carburetor and is designed to be used with a GM style throttle cable. Includes an adapter for use with a 700-R4 or a 200-4R transmission.



All..... #2284..... \$10.95/ea.

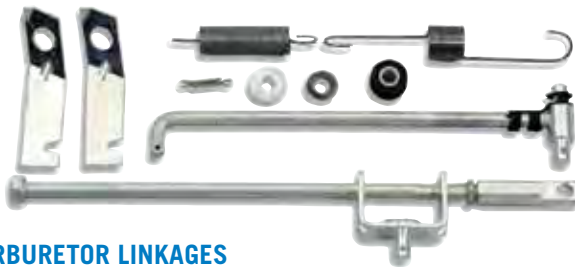

CARBURETOR LINKAGES

This assembly includes all the components necessary to completely replace your linkage. Parts are faithful to the originals, but far, far newer!

1956-57 Dual 4BC..... #1103..... \$59.95/set

CARBURETOR LINKAGE BUSHING/GROMMET KIT

The rubber part of this kit installs in both the carburetor shaft end and the throttle shaft end with the nylon bushing resting inside. The carburetor linkages then go thru this assembly and are held in place with the cotter pin connecting the carb to the throttle linkage.



1955-64 4-Piece..... #17148..... \$8.95/kit

BOWL TO CARBURETOR FUEL FILTER FITTINGS #1546

This is the fitting that installs into the carburetor where the fuel line enters when you install the fuel filters, #2104 or 1090. The filter assembly is threaded onto this fitting and then the fuel line is connected to the other side of the fuel filter assembly. One required.



1955-57 Carter, 1/8" NPT on Both Ends #1545..... \$2.95/ea.
 1956-57 Rochester, 1/8" NPT & 1/2-20 (1/4" Inverted Seat)..... #1546..... \$5.95/ea.



CARBURETOR REBUILDING KITS

We offer carburetor rebuilding kits that cover a wide variety of Chevrolet applications. Refer to the chart on page 316 to determine the kit that is best for your car. Use the Danchuk part number located in the middle and far right columns when ordering your kit.

- 1955-57 (Shown) #080A..... \$45.95/kit
- 1956-57 #080D..... \$41.95/kit
- 1955-57 #080B..... \$29.95/kit
- 1957..... #080F..... \$34.95/kit
- 1955-56 #080G..... \$34.95/kit
- 1955-57 #080H..... \$22.95/kit

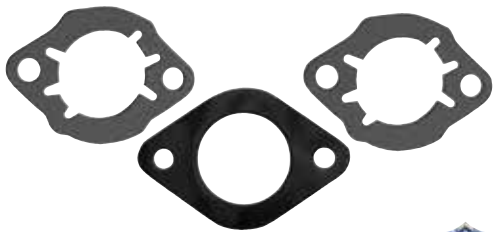

CARBURETOR SPACER BLOCK WITH GASKET

Made to original specs. This US made spacer block and gaskets are the perfect replacement for worn out originals.
 1955-57 6-Cyl..... #18355..... \$34.95/ea.



CARBURETOR CHOKE HOUSINGS

- 1956-58 Dual 4BC Carter WCFB, Threaded #12234..... \$45.95/ea.
- 1957-58 4BC Carter WCFB, Unthreaded #12235..... \$45.95/ea.



CHOKE SHAFT WITH BUTTERFLY

If your choke shaft and butterfly is missing from your carburetor this quality reproduction will get your classic back on the road in no time.

- 1955-58 4BBL..... #18947..... \$21.95/ea.



1955-58 CHOKE RELEASE ROD

When the choke release rod is missing from your carburetor it can make starting the engine a real problem. Replace yours with this quality reproduction.

- 1955-58 WCFB 4-BBL Carb #18946..... \$12.95/ea.

CARBURETOR REBUILDING KITS

Year	V8 Engine	Carburetor Type	Barrels	Carburetor Number	Danchuk Part #	Year	6 Cylinder Engine	Carburetor Type	Barrels	Carburetor Number	Danchuk Part #
1956-57	265, 283 w/ 2/4BC	Carter WCFB	4	2362; 2419; 2613, 14, 26, 27; 3181, 82	080A	1957	235	Rochester BC	1	7009656, 657, 784; 7011102; 7012127, 129, 502; 7013000, 003, 005, 955, 956, 7019000	080F
		Carter WCFB	4	2366; 2505, 55; 2655	080A						
		Rochester GC	4	7008737; 7009846; 7012126	080D						
1955-57	265, 283	Rochester GC	2	7005810; 7006825; 7008004, 005, 387 388; 7009345; 7010647, 648, 719; 7011131, 149, 224	080B	1955-56	235	Rochester BC	1	7001374; 7002050; 7003152; 160, 526 865, 986, 7004475, 477, 478, 495, 620, 915; 7005921, 922, 982, 7007172, 180, 181; 7009253, 254, 255	080G
1955	265	Carter WCFB	4	2218, 2351, 3759	080A	1955-57	235	Carter YF	1	756; 787; 788; 789; 964; 965; 966; 967 2008, 46; 2100, 01; 3211	080H



CARBURETOR AIR CLEANER RODS

Measured sizes are approximate.

1955 V8 4BC, 8-1/2".....	#1186.....	\$7.95/ea.
1955-56 V8 2BC, 7-1/2".....	#1187.....	\$9.95/ea.
1956 V8 4BC, 8-3/8".....	#1188.....	\$7.95/ea.
1956-57 Dual 4BC Pots to Air Cleaner, 7-7/8".....	#1189.....	\$9.95/ea.
1957 V8 Dual 4BC Air Clnr. to Carb, 7-1/2".....	#1190.....	\$17.95/set
1957-58 F.I., 4-3/4".....	#1191.....	\$7.95/ea.
1957 V8, 2BC.....	#11232.....	\$9.95/set
1957 V8, 4BC.....	#11233.....	\$9.95/set



CARBURETOR STUD KITS

The #14036 and #14037

are for use with 1/2 carburetor spacers.

All Black Oxide.....	#14036.....	\$25.95/set
All Stainless.....	#14037.....	\$33.95/set
All Standard Length, Black Oxide.....	#14019.....	\$25.95/kit
All Standard Length, Stainless.....	#14020.....	\$34.95/kit



CARBURETOR RETURN SPRINGS

1955-58 2BC.....	#1306.....	\$6.95/ea.
1955-58 4BC.....	#1309.....	\$8.95/ea.
1955-59 6-Cyl., Standard.....	#1307.....	\$8.95/ea.
1955-59 6-Cyl., Automatic.....	#1308.....	\$8.95/ea.

CARBURETOR INSULATOR

The insulator for the 235 6-cylinder engines is now available. No more making do with a cracked and brittle original. Be sure to order the required gaskets to do the job right.



1955-57 Original, 6-Cyl.....	#16638.....	\$7.95/ea.
------------------------------	-------------	------------

CARBURETOR INSULATOR GASKET

The insulator gaskets for the carburetor insulator are now available. Two are required per vehicle. Used only on the 6-cylinder engine.

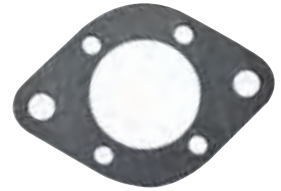

1955-57 6-Cyl.....	#16639.....	\$2.95/ea.
--------------------	-------------	------------



CARBURETOR BASE GASKETS

1957 WCFB Dual 4BC.....	#14171.....	\$4.95/ea.
1956-57 WCFB Single 4BC (Shown)	#14174.....	\$4.95/ea.

CARBURETOR SCREW SETS

After reconditioning the carburetor, it would be a shame to reassemble it with old or incorrect screws. These original design slotted filister head screws are cad plated and include stainless steel lock washers.



1955-64 2BC Rochester.....	#1885.....	\$5.95/set
1956-61 Dual 4BC Carter.....	#1886.....	\$22.95/set
1956-64 4BC Rochester.....	#1887.....	\$5.95/set



PUSH-ON CARBURETOR CLIPS WITH SPRINGS

1955-57 Carter WCFB.....	#14180.....	\$16.95/set
--------------------------	-------------	-------------



AIR HORN GASKET FOR WCFB DUAL 4-BARREL

1955-57.....	#14172...	\$4.95/ea.
--------------	-----------	------------



LOKAR HI-TECH THROTTLE CABLES

These are designed with a specially extruded liner for extended life of the cable. Cables are equipped with aluminum fittings and aluminum ferrule to eliminate fraying. "U-Cut-to-Fit" outer housing available in 24" or 36" lengths with a "U-Cut-to-Fit" stainless inner wire. Clevis is designed with cotter pins or set screws. Includes complete installation instructions.

- All 24", Hi-Tech, Stainless #11257 \$69.95/ea.
- All 24", Hi-Tech, Black #11258 \$59.95/ea.
- All 24", Hi-Tech, Stainless, LT1 & LT4 Tuned Port
..... #11259 \$89.95/ea.
- All 24", Hi-Tech, Stainless, LS1 & 350 Ramjet
..... #13014 \$85.95/ea.
- All 36", Hi-Tech, Stainless #13018* \$79.95/ea.
- All 24", Hi-Tech, Black #16278 \$79.95/ea.
- All 36", Hi-Tech, Black #16279 \$89.95/ea.
- All 36", Hi-Tech, Black, LS1/350 Ramjet
..... #16280 \$89.95/ea.



LOKAR REPLACEMENT INNER THROTTLE CABLE FOR LOKAR ASSEMBLIES

- All 36" #14828 \$29.95/ea.



LOKAR THROTTLE CABLE BRACKETS FOR EDELBROCK CARBURETORS

Machined aluminum for strength and style and fits single and dual Edelbrock carburetors. Allows easy installation of Lokar cable kits and comes with dual stainless return springs and hardware.

- All #15099 \$99.95/ea.
- All Black Anodized #16284 \$109.95/ea.



LOKAR THROTTLE CABLE BRACKET AND RETURN SPRING KITS

Stainless bracket mounts to the rear of Holley, Edelbrock, AFB, Quadrajet and In-Line Dual Quad carbs. Stainless bracket and GM designed dual stainless springs are used to mount Lokar's throttle cable and kickdown assemblies.

- All #11269 \$39.95/kit
- All Black Anodized #16285 \$44.95/kit



LOKAR CARBURETOR END FOR LOKAR THROTTLE CABLES

- All #14827 \$29.95/ea.



THROTTLE SHAFTS WITH ARMS

1957 Front & Rear, WCFB Dual 4BC

- #12282..... \$191.95/pr.
- 1957 Front, WCFB Dual 4BC..... #12283..... \$95.95/ea.
- 1957 Rear, WCFB Dual 4BC..... #12284..... \$95.95/ea.



THROTTLE ARMS

- 1955-57 V8 #1157..... \$16.95/ea.
- 1957 F.I. #12286..... \$84.95/ea.



1957 FAST IDLE ASSEMBLY FOR WCFB DUAL 4-BARREL

1957..... #14175..... \$59.95/ea.



THROTTLE PLATES

1956-57 WCFB..... #12285..... \$14.95/set



FAST IDLE SCREW & SPRING

1955-57 AFB & WCFB..... #14184..... \$4.95/ea.



IDLE MIXTURE ADJUSTMENT SCREWS

- 1956-57 Carter Dual 4BC..... #14181..... \$10.95/set
- 1955-57 Carter 4BC #14182..... \$9.95/set

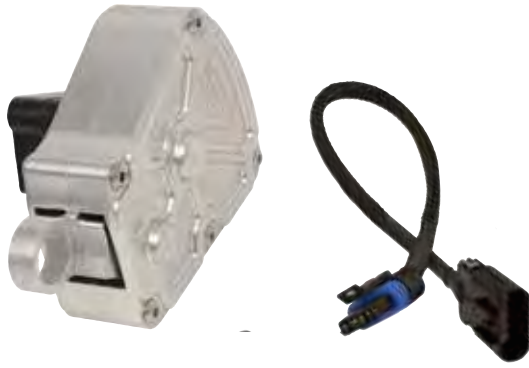

DRIVE BY WIRE THROTTLE CONTROLS WITH HARNESSES

The first programmable electronic throttle pedal (Drive By Wire) for the automotive aftermarket includes a programmable non-contact (Solid State) Hall Effect Sensor for most GM, Ford & Mopar applications. Also features a splined pedal arm for versatile mounting and all metal construction; aluminum and stainless steel. You can expect three times better performance over standard OEM pedals coming from over 90 years of combined throttle pedal experience. Sensor is programmed on the pedal to optimize electrical output for quick throttle response and no pedal lag. Pedal assembly sold separately.

- GM Crate Motors**..... #18375..... \$434.95/ea.
- 2007-2017 Silverado** #18376..... \$434.95/ea.
- 2006-12 Corvette** #18377..... \$434.95/ea.



DRIVE BY WIRE BILLET THROTTLE PEDAL

Throttle pedals are required to complete your drive by wire throttle pedal assembly.

- All w/ Rubber Insert** #16856..... \$137.95/ea.



#12176

#12174

LOKAR BILLET ALUMINUM TUNED PORT BRACKETS

These billet aluminum brackets mount to the side of the tune-port housing. The billet aluminum bracket is available with a single stud for throttle only; double stud for throttle and kickdown and triple stud for throttle, kickdown and cruise control cable.

- 1955-57 Single Stud** #12174..... \$54.95/ea.
- 1955-57 Double Stud**..... #12175..... \$54.95/ea.
- 1955-57 Triple Stud** #12176..... \$54.95/ea.



LOKAR BILLET THROTTLE PLATE WITH KICKDOWN AND RETURN SPRING KITS

Throttle plate includes brackets for the throttle cable, kickdown cable and spring return kit. Complete with two stainless steel return springs for safety.

- All Black** #17556..... \$186.95/kit
- All Brushed**..... #17557..... \$186.95/kit

LOKAR THROTTLE/KICKDOWN CABLE BRACKETS

Lokar's answer to LT1/4 cable problems. Stainless throttle and kickdown brackets replace factory brackets. Kit includes stainless arm to mount on LT1/4 throttle body to operate kickdown. Designed to be used with Lokar's tuned-port throttle and kickdown cables.



- 1992-'93 LT1** #13257..... \$89.95/ea.
- '94-Up LT1, LT4** #13258..... \$89.95/ea.



EDELBROCK THROTTLE SOLENOID AND BRACKET KIT

All..... #13356..... \$176.95/kit



1957 CHOKE ASSEMBLY

For 2627S & 2614S Carburetors.

1957 Dual 4BC..... #14185..... \$89.95/set



1957 CHOKE SHAFT AND BUTTERFLY VALVE

1957 WCFB 4BC & Dual 4BC..... #14186..... \$21.95/set



CHOKE TUBE HEAT KIT

Here's a convenient replacement kit for those burned-out originals. Easily installed, this kit will return your choke to smooth operation.

1955-57 #087..... \$19.95/kit

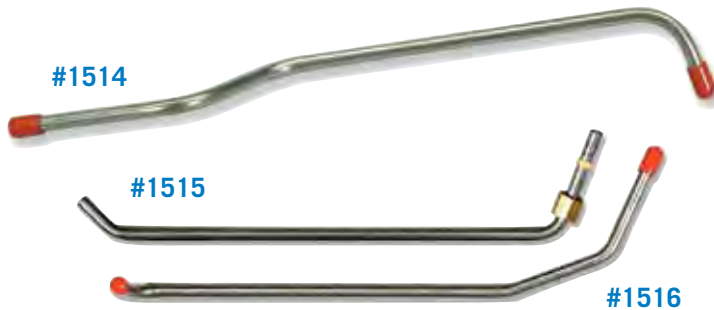

CHOKE HEAT RISER TUBES

Without this important part the carburetor cannot take advantage of the warm air from the exhaust manifold upon start-up. Bring back the efficiency and performance your car was designed with, and help restore the original look of your engine.

- 1955-56 6-Cyl. (Shown) #1514..... \$5.95/ea.
- 1955-56 2BC (Shown) #1515..... \$5.95/ea.
- 1955-56 Carter 4BC (Shown) #1516..... \$5.95/ea.
- 1956 Dual 4BC..... #1520..... \$5.95/ea.
- 1956 V8 Rochester 4BC..... #19146..... \$5.95/ea.
- 1957 6-Cyl..... #1517..... \$5.95/ea.
- 1957 2BC..... #1518..... \$5.95/ea.
- 1957 4BC..... #1519..... \$5.95/ea.



Photo courtesy of GERTMAN2000



#2594

CHOKE COVER

1957-62 (& Vette) WCFB #2594..... \$49.95/ea.



#17226

EDELBROCK UNIVERSAL CHOKE CABLE KIT

All..... #17226..... \$17.95/kit



CHOKE COVER

1955-56 4BC, Dual 4BC, Carter WCFB
..... #11220..... \$28.95/ea.



INTAKE MANIFOLD FITTINGS

See page 367 for stainless fittings.
1955-56 5/8" #10066..... \$17.95/ea.
1957 3/4" #12225..... \$16.95/ea.



#14763

#14764

#14765

VACUUM HOSE NIPPLE

1955-57 Stainless, 1/4" ID x 1-1/2", 1/8" NPT
..... #14764..... \$10.95/ea.

VACUUM/FUEL HOSE NIPPLES

1955-57 Stainless, 3/8" ID x 1-1/2", 1/8" NPT
..... #14763..... \$11.95/ea.
1955-57 Stainless, 3/8" ID x 1-3/4", 3/8" NPT
..... #14765..... \$13.95/ea.



#14761

#14762

VACUUM HOSE FITTINGS

1955-57 2-Port, Stainless, 3/8" NPT w/ 1/8" NPT Ports
..... #14761..... \$22.95/ea.
1955-57 1-Port, Stainless, 3/8" NPT w/ 1/8" NPT Ports
..... #14762..... \$19.95/ea.
All Vacuum Hose, 3/16" Hose, 1/8" NPT, Stainless
..... #15304..... \$11.50/ea.



INTAKE THERMOSTAT HOUSING STUDS

1956-61 Dual 4BC & FI..... #2654..... \$4.95/pr.



INTAKE MANIFOLD STUDS

1955-57 6-Cyl. to Manifold..... #11208..... \$3.50/set



STAINLESS INTAKE MANIFOLD BOLTS

- All Hex, 396-454 BB..... #13993..... \$72.95/set
- All 12-Point, 396-454 BB (Shown) #13994..... \$75.95/set
- All Hex, SB exc. Vortec (Shown) ... #13995..... \$54.95/set
- All 12-Point, SB exc. Vortec #13996..... \$57.95/set
- All Hex, SB w/ Vortec #13997..... \$39.95/set
- All 12-Point, SB w/ Vortec #13998..... \$43.95/set

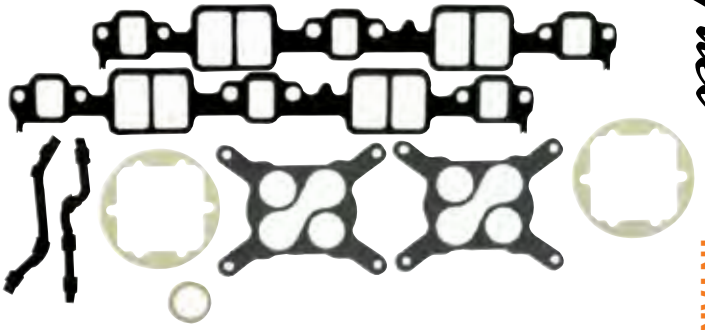

INTAKE MANIFOLD AND CARBURETOR GASKET KITS

This kit includes manifold, carburetor, and air filter housing gaskets for single or dual four barrel carburetor configurations.

- 1957-61 Dual 4BC..... #1350.....\$48.95/kit
- 1957-60 Single 4BC..... #1350A.....\$51.95/kit



INTAKE MANIFOLD BOLTS

- All SB..... #13390..... \$13.95/set
- All BB..... #13391..... \$17.95/set

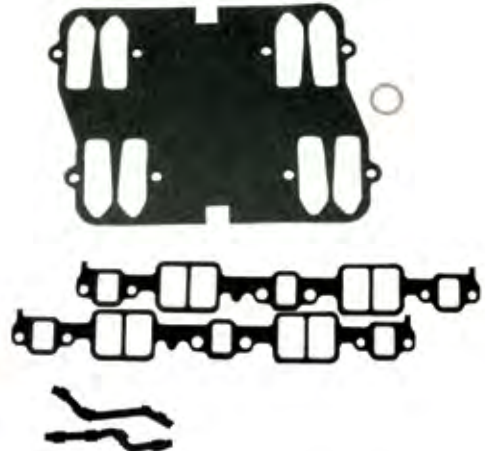

INTAKE MANIFOLD AND FUEL INJECTION GASKET KIT

Includes manifold and fuel injection unit gaskets.

- 1957-58 Fuel Injection. #1351.....\$56.95/kit



INTAKE MANIFOLD BOLTS

These bolts are exact duplicates of the originals with the correct head markings. 12 per set.

- 1955-63 #2652..... \$20.95/set



INTAKE MANIFOLD WASHERS

- 1955-64 SBw/ Aluminum Manifold #2195..... \$8.95/set



INTAKE MANIFOLD GASKETS WITH BLOCK-OFF PLATE

These gaskets, with exhaust crossover block off plates, keep the intake manifold cooler providing for a denser fuel mixture.

- 1955-56 #14867..... \$41.95/set
- 1957-64 Dual 4BC & Fuel Injection #2655..... \$42.95/set

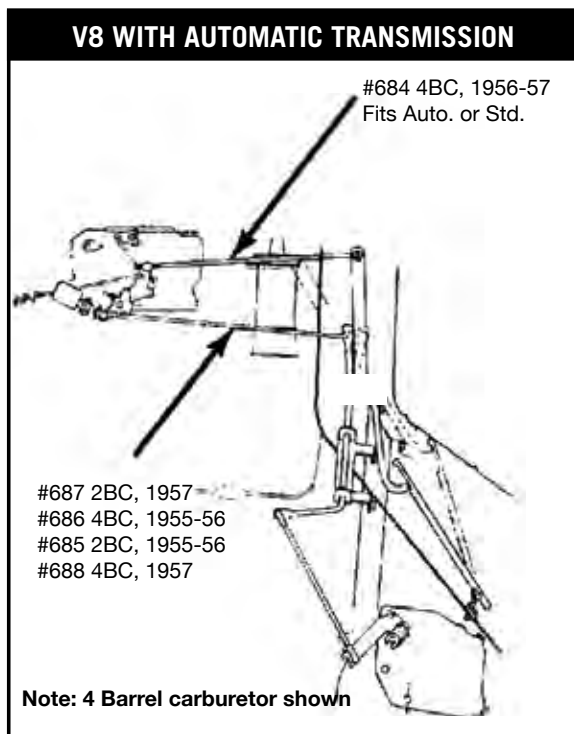
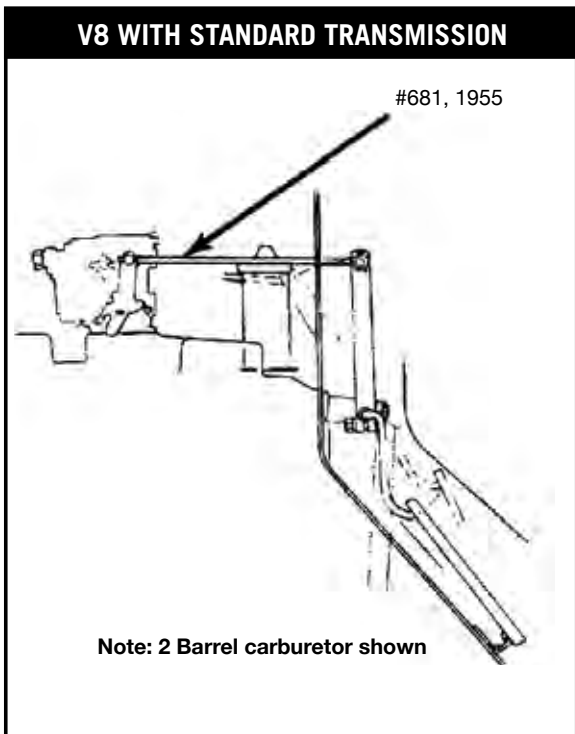
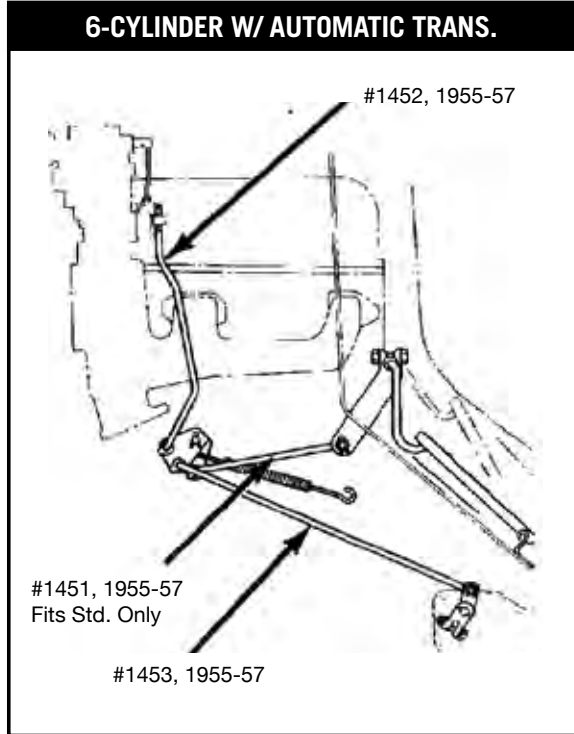

ACCELERATOR LINKAGE SLEEVE

All 1955-67 GM engines use two sleeves each except for 4 barrel carburetors and fuel injected cars, which use only one. See part #079 shown at right.



1955-67 #1877 \$2.95/ea.

CARBURETOR GROMMET

This grommet is necessary to connect the carburetor linkage to the carburetor. Don't forget an accelerator linkage sleeve, part #1877, shown at left.



1955-57 #079 \$3.95/ea.



#681



#682



#683

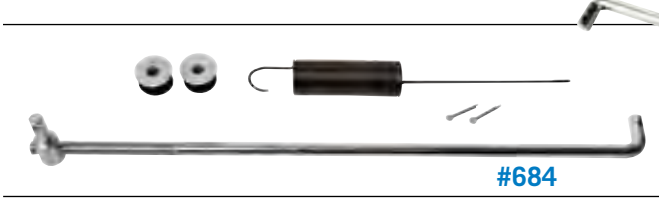

#684



#689



#1451



#1452

ACCELERATOR LINKAGE ASSEMBLIES

Limping around on a shoddy accelerator linkage rod? Are you missing out on that burst of power due to a broken passing gear linkage rod? Don't leave safety to chance, replace these critical parts with dependable new ones. Measured sizes are approximate.

- 1955 V8 2BC, 10-1/2"..... #681..... \$31.95/set
- 1955 V8 4BC, 11"..... #682..... \$31.95/set
- 1956-57 V8 2BC, 10-1/8"..... #683..... \$31.95/set
- 1956-57 V8 4BC, 11"..... #684..... \$31.95/set
- 1957 F.I., 6-1/2"..... #689..... \$24.95/set
- 1955-57 6-Cyl., Lower, 10"..... #1451..... \$23.95/set
- 1955-57 6-Cyl., Upper, 12-1/2"..... #1452..... \$23.95/set

LINKAGE ROD CLIPS

When replacing linkage rods, it's a good idea to replace your linkage rod clips. Part #1566 is equivalent to GM part #3700188 and part #1567 is like GM part #3711177.

- 1955-57 Right Hand Type..... #1566..... \$1.95/ea.
- 1955-57 Left Hand Type..... #1567..... \$1.95/ea.



#685



#688



#686



#1453



#2199

UPPER PASSING GEAR LINKAGE RODS

- 1955-56 V8 2BC, 9-1/2"..... #685..... \$24.95/set
- 1955-56 V8 4BC, 10-3/4"..... #686..... \$24.95/set
- 1957 V8 2BC, 11-1/2"..... #687..... \$24.95/set
- 1957 V8 4BC, 12-5/8"..... #688..... \$24.95/set
- 1955-57 6-Cyl., 12-3/4"..... #1453..... \$24.95/set
- 1955 Early Model 4BC, 7-1/2"..... #2199..... \$24.95/set



LOWER PASSING GEAR LINKAGE RODS

- 1955-56 (Shown)..... #1876..... \$34.95/ea.
- 1957-62..... #1884..... \$16.95/ea.



LINKAGE BRACKET AND SPRING CARBURETOR/ACCELERATOR

- 1956-64 Dual 4BC..... #11231..... \$34.95/set

ACCELERATOR PEDAL ROD BUSHINGS

These bushings support the accelerator pedal rod where it runs through the bracket that mounts to the firewall. There is one on each end of the bracket tube and the accelerator rod slides through them.



- 1955-57 Through Firewall..... #12648..... \$3.95/pr.

AIR CLEANERS



#13837

#13836

ANODIZED ALUMINUM AIR CLEANERS WITH BOWTIE LOGOS

Super-light 14-inch air cleaners are made of aircraft aluminum in either black or clear anodized finishes plus a 3-inch AC filter, recessed aluminum base and mounting hardware.

- All 14" Black #13836..... \$96.95/ea.
- All 14" Clear #13837..... \$96.95/ea.



#13833

BLACK CRINKLE AIR CLEANER CHEVROLET WITH BOWTIE WING NUT

- All 14", 5-1/8" Flange #13833..... \$86.95/ea.



#13162

EDELBRÖCK AIR CLEANER

#18462

Fits carburetor w/ 5-1/8-inch flange.

- All Chrome, 14" w/ 3" Element #13162..... \$34.95/ea.

EDELBRÖCK AIR CLEANER PRO-FLO SERIES

- All Black, 14" #18462..... \$34.95/ea.



#15000

#15002

EDELBRÖCK CLASSIC FINNED AIR CLEANERS

Classic Finned design harkens back to the vintage look of the 50's and 60's. They feature cleanable filter elements and come in either polished or classic black. Dual 4-barrel applications are for carburetors with a 6-7/16-inch center to center spacing. 5-1/8-inch flange.

- All Polished, Small Oval, 4BC #15000.... \$239.95/ea.
- All Polished, Large Oval, Dual 4BC #15001..... \$238.95/ea.
- All Black, Small Oval, 4BC #15002..... \$163.95/ea.
- All Black, Large Oval, Dual 4BC #15003..... \$173.95/ea.

EDELBRÖCK VICTOR SERIES AIR CLEANERS

Victor series air cleaners feature a textured black powder coated finish for a pleasing and unique finish same as the NASCAR series manifolds. 5-1/8-inch flange.



- All Black, 14" Round w/ 3" Element #14997..... \$141.95/ea.
- All Black, Oval w/ 2.4" Element #14998..... \$125.95/ea.



BILLET SPECIALTIES OVAL AIR CLEANERS

Fits 4-barrel carbs with a 5-1/8 air horns.

- All Small, Ball Milled #17069..... \$134.95/ea.
- All Large, Ball Milled #17070..... \$149.95/ea.
- All Large, Ribbed, Polished #17064..... \$179.95/ea.



BILLET SPECIALTIES AIR CLEANERS

- All Vintage 14", 4BC, Polished #17584..... \$249.95/ea.
- All Vintage 14", 4BC, Black #17585..... \$249.95/ea.
- All Classic 14", 4BC, Polished #17586..... \$229.95/ea.

RETRO ROD AIR CLEANER ASSEMBLY

Based on the 56 Cadillac/Olds air cleaner assembly. This 7/8 scale version was built with Tri-fives in mind. Designed to clear the factory wiper motor and aftermarket HEI distributors. Fits 4-barrel carbs with 5-1/8 air horn and includes filter and rocket shaped wing nut.



- All 4BC..... #17987..... \$146.95/ea.

BILLET SPECIALTIES STREAMLINE AIR CLEANER

Billet Specialties Streamline air cleaners offer a fresh new look for your classic Chevy. Precision machined billet aluminum tops capped off with a 3D machined wing nut compliment any exterior cues.



- All 14" Round, Black #17791..... \$289.95/ea.

CHROME AIR CLEANER

This beautiful chrome air cleaner includes a genuine AC Delco air filter for maximum airflow. Top quality chrome plating protects each part. All air cleaners fit carburetors with 5-1/8" diameter air horns. Note: After installation, lower hood slowly to confirm sufficient clearance.



- All 14" #1946..... \$68.95/ea.



Photo courtesy of GERTMAN2000



ARP AIR CLEANER STUD KITS

- All 1/4" x 2.443"..... #18227.....\$8.95/kit
- All 1/4" x 2.70"..... #18228.....\$11.95/kit
- All 1/4" x 3.20"..... #18229.....\$11.95/kit

AIR CLEANER SPACERS

These air cleaner spacers mount between the carburetor and air cleaner assembly. They fit 4-barrel air cleaners with a 5-1/8" opening. Air cleaner spacers give you additional clearance for fuel lines, linkage, etc.



- All 3/4" #15277..... \$7.95/ea.
- All 1/2" #15278..... \$11.95/ea.

AIR CLEANER OIL RESERVOIR SEAL

Disassemble the air cleaner and you're likely to find the oil reservoir seal damaged or missing entirely. Without this seal, the air cleaner assembly can be bent out of shape by over tightened bolts.



- 1955-56 4BC #1747..... \$6.50/ea.



AIR CLEANER TO CARBURETOR GASKETS

- 1955-57 V8 2BC #2201..... \$2.50/ea.
- 1955-57 V8 4BC #2201A..... \$2.95/ea.



BATWING AIR CLEANERS ^{O/S}

We have been missing these beautiful reproductions for a few years now but we are very happy to say that they are back and, literally, better than they have ever been. All of the tooling has been completely re-made or re-worked and the results are amazing. These babies are as beautiful as the picture you're looking at. **Made in the USA.**

- 1956 Dual 4BC..... #1901..... \$1295.95/ea.
- 1957 Dual 4BC w/ Deluxe Heater.. #1901A... \$1295.95/ea.
- 1957 Dual 4BC w/ Standard Heater
..... #1901B... \$1295.95/ea.

1957 AIR CLEANER CONVERSION KIT

Contains air cleaner bottom parts to convert a 1958 2 or 4-barrel carburetor air cleaner to a 1957 4-barrel carburetor.



- 1957 4BC..... #2646..... \$82.95/kit

AIR CLEANER LOWER SUPPORT BRACKET

The 1955 and 1956 air cleaners are supported by the carburetor and this bracket, which mounts to the intake manifold. Replace that rusty original.



- 1955-56 6-Cyl..... #1490..... \$23.95/ea.

AIR CLEANER WING NUTS

These quality die-cast wing nuts are offered in two sizes. Use the larger size for the 14" and 10" air cleaners, and the smaller size for the 6-3/4" air cleaner. Nut bodies are chrome, with glossy red and black plastic inserts, coated with durable epoxy. Nuts fit both 1/4"-20 and 5/16"-18 studs.



- All Small, Bowtie #1948 \$11.95/ea.
- All Large, Bowtie #1947 \$13.95/ea.
- All Small, Hi-Tech Spinner #1950 \$11.95/ea.
- All Large, Hi-Tech Spinner #1949..... \$13.95/ea.

AEROMOTIVE HIGH OUTPUT BILLET FUEL PUMPS

Ideal for carbureted power plants not using a separate fuel pressure regulator. The H/O Fuel Pump is designed for engines making 200-600 HP and is ideal for street cars and mild race cars alike. Similar to our SS Fuel Pump (Part #17715), but internally regulated to 7 PSI.



All 7 PSI..... #17716..... \$249.95/ea.



AEROMOTIVE STEALTH 340 FUEL PUMP

The Aeromotive 340 Stealth fuel pump will replace the pump supplied in the Danchuk # 17742 and 17743 Aeromotive universal in tank kits, the pump in the # 17744 Aeromotive Tri-Five fuel tank and the pump that comes supplied with the Danchuk # 14947 and 14948 OE style FI fuel tanks. It may also fit other aftermarket FI tanks.

All..... #18991..... \$122.95/ea.

AEROMOTIVE SS SERIES BILLET FUEL PUMPS

A fuel pump that allows you to step up your performance by maintaining optimal line pressure and delivering high volume. The Street/Strip Pump was engineered for 200-750 HP carbureted engines making this a perfect choice for a daily driver, street rod or demanding ET-bracket race car. Comes with 3/8" NPT ports.



All SS Series, 14 PSI..... #17715..... \$235.95/ea.



AEROMOTIVE A750 FUEL PUMP

The Aeromotive A750 fuel pump is compact, quiet and durable. Made from billet, these in-line pumps are ideal for low to medium HP applications. Perfect for street rods and muscle cars, fuel injected or carbureted. Handles fuel injected engines up to 800HP naturally aspirated and 600HP with forced air induction. Handles carbureted engines up to 1000HP naturally aspirated and 800HP with forced air induction. The A750 is also fully submersible for custom in tank placement and has ORB-8 inlet and ORB-6 outlet ports. Not suited for diesel fuel applications.

All Black..... #18994..... \$423.95/ea.

AEROMOTIVE SS SERIES PLATINUM BILLET FUEL PUMPS

Same as our #17715 pump, but with a mirror nickel finish for the show car builder.



All 14 PSI..... #17717..... \$283.95/ea.



AEROMOTIVE A1000 FUEL PUMP

The Aeromotive A1000 fuel pump is durable, reliable, good looking and it supports high horsepower. Perfect for the daily driver that doesn't run like a daily driver. Handles fuel injected engines up to 1300HP naturally aspirated and 1000HP with forced air induction. Handles carbureted engines up to 1500HP naturally aspirated and 1200HP with forced air induction. The A1000 is also fully submersible for custom in tank placement and has ORB-10 inlet and outlet ports. Not suited for diesel fuel applications.

All..... #18993..... \$439.95/ea.

**AEROMOTIVE PHANTOM
UNIVERSAL IN-TANK FUEL PUMPS**

Aeromotive Phantom Stealth Fuel Systems solve the problem of what to do for a tank when making a switch to EFI or swapping a late model engine into your classic. These fully universal systems will fit virtually any tank from 5.5" to 11" deep, plastic, steel, aluminum, corrugated or smooth. All you do is cut a hole in the top of your tank, measure the depth, cut your pump hanger bracket to length and trim your baffle/basket foam and install. The 340 system will support 700 HP EFI supercharged or 1000 HP carbureted supercharged. The 200 system will support 425 HP EFI supercharged or 500 HP carbureted supercharged or 550 HP EFI normally aspirated or 750 HP carbureted normally aspirated. Must be used with a return style system.



All 340 Pump	#17742.....	\$549.95/ea.
All 200 Pump	#17743.....	\$529.95/ea.



AEROMOTIVE BILLET FUEL PUMP BRACKET

For use with part #17715-17 fuel pumps. Features mirror nickel finish.

All 2-1/2" Diameter	#17718.....	\$112.95/ea.
----------------------------------	--------------------	---------------------



AEROMOTIVE BILLET FUEL FILTER BRACKETS

For use with Aeromotive in-line filters. Part #17725 features a mirror nickel finish.

All In-Line	#17722.....	\$89.95/ea.
All Platinum Series	#17725.....	\$99.95/ea.

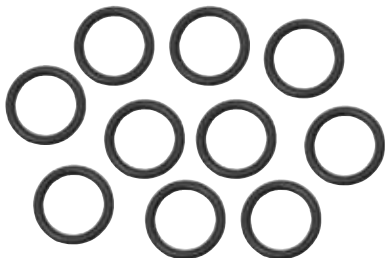

AEROMOTIVE FUEL RESISTANT NITRILE O-RINGS

Fuel resistant nitrile O-rings. Pack of 10 for servicing ORB type fitting on Aeromotive filters and regulators.

All -6AN, 10-pk	#17737.....	\$11.95/kit
All -8AN, 10-pk	#17738.....	\$11.95/kit
All -10AN, 10-pk	#17739.....	\$11.95/kit

AEROMOTIVE ORB-6 HEX PORT PLUG

These Aeromotive plugs are the right way to cap off ports in fuel and other components. The hard-anodized aluminum plugs use O-rings for proper sealing.



All.....	#18186.....	\$6.95/ea.
-----------------	--------------------	-------------------

AEROMOTIVE FUEL FILTER REPLACEMENT O-RINGS

Replacement O-rings for servicing Aeromotive's in-line fuel filters.

All 10-pk.....	#17719.....	\$8.95/kit
-----------------------	--------------------	-------------------

AEROMOTIVE CARBURETED PHANTOM IN-TANK UNIVERSAL FUEL SYSTEM

Aeromotive's all-new returnless Carbureted Phantom is a cost-effective way to install a fuel system for any carbureted system, in virtually any fuel tank. For those customers who want the ease of a returnless carbureted system in their car and are tired of loud, noisy T-style pumps, Aeromotive's new Carbureted Phantom is the way to go. Line pressure is pre-set to 15 psi. Equipped with the Aeromotive Stealth 325 pump, the Phantom Carbureted System is capable of supporting up to 900 horsepower naturally aspirated, 750 horsepower forced induction, on gasoline. **REQUIRES** the use of a fuel pressure regulator suitable for your particular application. Not suitable for use with diesel, E85 Ethanol or Methanol.



All..... #18992..... \$441.95/ea.



AEROMOTIVE IN-LINE FUEL FILTERS

An inexpensive insurance policy to protect your investment, proper filtration is key to fuel system performance. Engineered filter solutions are required to achieve protection with minimum restriction. For 200-3,000 plus HP applications, our filter assemblies offer unmatched flow, ease of installation and maintenance, along with the impeccable machining and finish you've come to expect from all Aeromotive components. 10 Micron filters are for use after the fuel pump, 100 micron filters are used before the pump.

All 10 Micron, Red..... #17720..... \$119.95/ea.
 All 100 Micron, Red..... #17721..... \$149.95/ea.

AEROMOTIVE IN-LINE FUEL FILTERS

Same as #17720-21, but with mirror nickel finish for a chrome like appearance.

All 10 Micron, Platinum Series..... #17723..... \$129.95/ea.
 All 100 Micron, Platinum Series... #17724..... \$157.95/ea.



AEROMOTIVE REPLACEMENT FILTER ELEMENTS

Commonly the most overlooked component in a fuel system, filter neglect can be the most costly. If not cleaned or replaced regularly, filter elements can become clogged resulting in reduced fuel flow, engine performance and ultimately, fuel pump or even worse, engine damage. By simply replacing and/or cleaning your filter elements regularly, you can avoid costly repairs to your fuel system and ensure peak engine performance. For use with part #17720 or 17721.

All 10 Micron #17726..... \$19.95/ea.
 All 100 Micron #17727..... \$45.95/ea.

AEROMOTIVE REDUCER FITTINGS

Use on fuel systems where a reduction in port size is required such as Aeromotive's in-line fuel filters.



All ORB -10 to -6 AN Black..... #17740..... \$19.95/ea.
 All ORB -10 to -8 AN Black..... #17741..... \$19.95/ea.



AEROMOTIVE UNIVERSAL (CARB/EFI) BYPASS REGULATORS, 3-PORT

A dual purpose, universal regulator for EFI or carbureted street or strip applications. Base pressure adjustable from 3 to 20 PSI with standard spring, (installed) or from 20 to 60 PSI with high pressure spring (included). Offers the full flow and rock steady fuel pressure that only a dynamic, Aeromotive bypass regulator provides. Platinum series features mirror nickel show car finish.

- Capable of regulating any fuel pump between 100 and 250 GPH.
- Fuel pressure rises on a 1:1 ratio when referencing boost.
- All ports are 3/8" NPT, with one inlet and three outlets on the main body and one return port on the bottom.
- Bypass design provides the ultimate, dynamic fuel pressure control.

All 3-Port #17731 \$179.95/ea.
 All 3-Port, Platinum #17732 \$198.95/ea.

AEROMOTIVE EFI BYPASS REGULATOR AND FITTING KIT WITH GAUGE

This EFI Bypass Regulator kit encompasses features and benefits only found on Aeromotive regulators in a new smaller and lighter package. Capable of supporting applications up to 1000 HP, the EFI Bypass Regulator can handle high-flow EFI fuel pumps and the most aggressive street machines; especially those looking for a cleaner, lighter solution where performance is critical or where space is a premium. This Kit comes with fittings and gauge to simplify installation.

- Base pressure adjustable from 30-70 PSI
- Fuel pressure rises on a 1:1 ratio with boost
- Provides two ORB-06 inlet/outlet ports and one ORB-06 return port
- 1/8" NPT gauge port
- Vacuum boost port
- CNC-Machined 6061 T6 billet aluminum construction
- Stainless steel mounting bracket

All..... #17728..... \$221.95/kit



AEROMOTIVE CARBURETOR ADJUSTMENT REGULATORS, 2-PORT

Specifically designed for carbureted street or racing engines, these adjustable regulators offer higher flow, quicker response and less pressure creep than competing two-port designs. Ideal for dedicated nitrous applications. These regulators are used by many of the NASCAR® teams. Platinum series features a mirror nickel show car finish. Features Include: Adjustable from 5-12 PSI, 1/8" NPT gauge port, Regulators re-seat after the carburetor needle shuts down, preventing pressure creep, includes mounting bracket, and part #17729 provides 3/8" NPT inlet and outlet ports.

All..... #17729..... \$117.95/ea.
 All Platinum Series #17730..... \$129.95/ea.



AEROMOTIVE FUEL PRESSURE GAUGES

Both Aeromotive high and low pressure versions feature a unique pressure equalization pin that permits you to equalize internal gauge case pressure to atmosphere, restoring accuracy, regardless of operating temperature.

All 0-15 PSI, 1/8 NPT #18027 \$47.95/ea.
 All 0-100 PSI, 1/8 NPT #18028 \$47.95/ea.

**AEROMOTIVE A1000
CARB BYPASS
REGULATOR**

The A1000 bypass regulator was designed for use with the Aeromotive A1000 Fuel Pump or similar style EFI pumps in a carbureted application. This regulator is perfect for naturally aspirated or 'blow-through' super-charged engines. Ideal for converting from fuel injection to carburetion using the stock, in-tank pump. It features (1) ORB-10 inlet and (1) ORB-8 return port, (2) ORB-6 outlet ports and a dedicated 1/8" NPT fuel pressure gauge port. Adjustable for pressure ratings between 3-15 PSI.
All..... #18996..... \$209.95/ea.



**AEROMOTIVE GEN2
A1000 EFI REGULATOR**

This A1000 fuel pump regulator is a high Performance, adjustable EFI regulator designed for medium to high horsepower applications. It features Aeromotive's high-flow design, superb pressure control, legendary durability, (2) ORB-6 inlet and outlet ports, (1) ORB-6 return port and a dedicated 1/8" NPT fuel pressure gauge port. Adjustable for pressure ratings between 40 & 70 PSI it is also compatible with diesel, gas, ethanol and methanol.



All..... #18995..... \$210.95/ea.

AEROMOTIVE REGULATOR FITTINGS

Contains three AN-06 to AN-06 male flare fittings.
All -6AN #17733..... \$49.95/kit



AEROMOTIVE X1 EFI REGULATOR

From carbureted to EFI pressures, naturally aspirated or forced induction, the X1 is designed to span the entire range of applications providing dependable fuel pressure regulation. Making the change from carburetor to EFO or EFI to carburetor?? There is no longer the need to purchase a new regulator. Simply utilize one of three conversion kits (Sold separately) to match the operating range required for your engine. Utilizes a larger (3) -8AN inlet/outlet/return ports, 1/8" NPT gauge port and 1:1 ratio boost reference port for easy forced induction connection.



1955-57 #19359..... \$216.95/ea.

AEROMOTIVE CARB AND EFI REGULATOR FITTINGS

All -8AN #17734..... \$49.95/kit



#17735

AEROMOTIVE CARBURETOR REGULATOR FITTINGS

Contains three 3/8" to AN-06 male flare adapter fittings.
All -6AN #17735..... \$29.95/kit



Contains three 3/8" to AN-08 male flare adapter fittings.
All -8AN #17736..... \$29.95/kit



O-RING BOSS PORT PLUG
1955-57 ORB-8
..... #19360.\$12.95/ea.



ORB TO AN FLARE FITTINGS
1955-57 ORB-8 to 6
..... #19361.\$19.95/ea.
1955-57 ORB-8 to 8
..... #19362.\$19.95/ea.



INTAKE MANIFOLDS

EDELBROCK PERFORMER RPM INTAKE MANIFOLDS

Performer RPM is a step up the performance ladder for your street machine. The Performer RPM Air-Gap series have an open space that separates the runners from the hot engine oil resulting in cooler manifold runners and more power. Order the Vortec version if you are running Vortec heads. 1500-6500 power range. Use with square bore carburetors only.

1955-86 SB, Performer RPM, Cast.....	#13118.....	\$217.95/ea.
1955-86 SB, Performer RPM, Endurashine.....	#13361.....	\$348.95/ea.
1955-86 SB, Performer RPM Air-Gap, Cast.....	#13116.....	\$278.95/ea.
1955-86 SB, Performer RPM Air-Gap, Endurashine.....	#13360.....	\$462.95/ea.
All BB, Performer RPM Air-Gap w/ Oval Port, Cast.....	#13123.....	\$325.95/ea.
All BB, Performer RPM Air-Gap w/ Oval Port, Endurashine.....	#13364.....	\$559.95/ea.
All Vortec Heads Performer RPM Air-Gap, Cast.....	#13119.....	\$345.95/ea.
All Vortec, Performer RPM, Endurashine.....	#14733.....	\$379.95/ea.



EDELBROCK PERFORMER LS3 CARBURETOR INTAKE MANIFOLD

Designed for Gen IV engines with LS3, L92 and L76 rectangular port cylinder heads. The Performer RPM LS3 manifold is ideal for anybody looking to build a carbureted LS3 or LS2 engine with an operating range between 1,500 - 6,500 rpm. It allows the use of a carburetor on these originally computer-controlled engines, offering maximum power and a broad torque curve. It features a high-rise dual-plane design combined with a plenum that has been optimized for square-bore carburetors. Performer RPM LS3 includes a provision for mounting an MSD Ignition Timing Control Module, part #17631, including passages for routing the coil wire harness, for a clean look. A special throttle and transmission bracket that works with 700R-4, 200-4R and Turbo 350 transmissions is also included, making this an easy retro-fit for your classic.

All..... #18136..... \$383.95/ea.



EDELBROCK PERFORMER RPM LS1 INTAKE MANIFOLD

This powerful manifold will fit the LS1 and LS6 as well as the LM-7 (5.3L), LR4 (4.8L) and the truck LQ4 (6.0L) Gen III engines. It allows the use of a carburetor on these computer controlled engines and includes a MSD timing control module that works with the OE sensors to fire the coil-on-plug system. Kit also includes a special throttle and transmission bracket that works with 700R4, 200-4R and TH350 transmissions making the engine an easy retro-fit for your classic.

1997-Up with Timing Module, LS1

..... #13700... \$1054.95/ea.



EDELBROCK PERFORMER INTAKE MANIFOLDS

The Performer is one of the best intakes for street performance and Danchuk #13112 has the provision for an original oil tube. Power range is from idle to 5500 RPM. Use with a spread bore or square bore carburetor. Order Vortec version if you are running Vortec heads. Big Blocks will not fit "tall blocks".

1955-86 SB, Cast.....	#13112.....	\$182.95/ea.
1955-86 BB, Oval, Cast.....	#13121.....	\$287.95/ea.
All SB, Vortec, Cast.....	#13114.....	\$255.95/ea.
All SB, Vortec, Endurashine.....	#13359.....	\$384.95/ea.



Fuel

INTAKE MANIFOLDS



EDELBROCK PERFORMER EPS INTAKE MANIFOLDS

This newest version of the Performer manifold has ports that are better tuned to give you a gain of up to 5HP and 9 ft./lbs. of torque over the original Performer in the 3000-4500 RPM range. Power range is from idle to 5500 RPM. Use with square bore carburetors only.

1955-86 SB, Cast.....	#13110.....	\$145.95/ea.
1955-86 SB, Endurashine.....	#13358.....	\$335.95/ea.
1955-86 SB w/ Filler Tube/Breather, Cast.....	#14990.....	\$243.95/ea.
1955-86 SB w/ Filler Tube/Breather, Endurashine.....	#14991.....	\$417.95/ea.
1996-Up SB Vortec, Endurashine.....	#15294.....	\$383.95/ea.
All SB Vortec, Cast.....	#14732.....	\$268.95/ea.



EDELBROCK PERFORMER AIR-GAP INTAKE MANIFOLDS

Performer Air Gap manifolds are a dual-plane low-rise design like the Performer series with the addition of Edelbrock's patented Air Gap and is designed for all 1955-86 262-400 c.i.d. small blocks. The Air Gap design features an open air space that separates the runners from the hot engine oil resulting in cooler runners and more power. High velocity runners deliver excellent throttle response in the idle to 5500 PRM power range and the Endurashine finish gives you a brilliant shine that won't oxidize, fade or discolor like chromed or polished manifolds. No provision for exhaust heated chokes or exhaust crossover. Use with spread bore or square bore carburetors.

1955-86 SB, Cast.....	#13115.....	\$289.95/ea.
1955-86 SB, Endurashine.....	#16525.....	\$442.95/ea.



SMALL BLOCK MANIFOLDS AND CARBURETOR KITS

It's easy to upgrade your induction system with the best combination of Edelbrock proven performance and looks in a single box. These kits include: an Edelbrock manifold and a performer or Thunder AVS series carburetor with Standard finish to suit your engines air and fuel requirements, a chrome fuel inlet, high quality Edelbrock intake gasket set, intake bolt set and carburetor stud kit.



1957-86 Performer EPS, 600 Carburetor	#17165.....	\$556.95/kit
1957-86 Performer Air Gap, 600 Carburetor	#17166.....	\$695.95/kit
1957-86 Performer RPM, AVS 800 Carburetor	#17167.....	\$725.95/kit
1957-86 RPM Air Gap, AVS 800 Carburetor	#17168.....	\$782.95/kit

SMALL BLOCK MANIFOLD WITH INSTALL KITS

Edelbrock has packaged all the necessary components to replace your stock iron intake manifold. These kits include an Edelbrock aluminum intake manifold, intake gasket set, carburetor base gasket, RTV sealant, intake bolts and carburetor studs for an all-in-one-box installation for your classic Chevy. Get better performance from a simple manifold replacement kit.



1957-86 Performer EPS w/ Install Kit	#17162.....	\$239.95/kit
1957-86 Performer RPM w/ Install Kit	#17163.....	\$269.95/kit
1957-86 RPM Air Gap w/ Install Kit	#17164.....	\$322.95/kit

EDELBRUCK THUNDER SERIES CARBURETORS

Thunder AVS (Air Valve Secondary) Carburetors are designed to deliver optimum performance. The quick-tune adjustable valve secondary allows you to adjust the secondaries to suit a variety of needs with simple tools, no springs required, can be configured for either single or dual feed. Fits square bore pattern manifolds.



All AVS, 650 CFM, Electric Choke (Shown)	#13076	\$355.95/ea.
All AVS, 800 CFM, Electric Choke.....	#13077	\$476.95/ea.
All AVS, 650 CFM, Electric Choke, Endurashine.....	#14052.....	\$561.95/ea.
All AVS, 500 CFM, Electric Choke, Endurashine (Shown)	#14054.....	\$514.95/ea.
All AVS, 500 CFM, Manual Choke, Endurashine	#14055.....	\$514.95/ea.

EDELBROCK PERFORMER SERIES CARBURETORS

Edelbrock Performer Series carburetors are designed to handle the rigors of daily driving while delivering consistent reliable street performance from day to day. They use metering rods to transition between circuits which means they are unaffected by engine backfires as they have no power valve to blow out, and the rods can be changed in seconds for easy tuning. And they STAY tuned so performance remains constant day in and day out. Manual choke models are calibrated for optimum performance, the electric choke versions are calibrated for optimum fuel economy. Fits square bore manifolds. Not legal for sale or use on pollution controlled vehicles.



#13078

All 500 CFM, Electric Choke, Non-EGR.....	#14720.....	\$401.95/ea.
All 500 CFM, Manual Choke, Non-EGR	#14721.....	\$346.95/ea.
All 600 CFM, Manual Choke (Shown).....	#13078.....	\$319.95/ea.
All 600 CFM, Electric Choke.....	#13079.....	\$356.95/ea.
All 600 CFM, Manual Choke, Endurashine.....	#15678.....	\$457.95/ea.
All 600 CFM, Electric Choke, Endurashine	#14053.....	\$525.95/ea.
All 750 CFM, Electric Choke.....	#13080.....	\$393.95/ea.
All 750 CFM, Manual Choke	#13081.....	\$379.95/ea.



EDELBROCK PERFORMER CARBURETOR WITH BLACK FINISH

Edelbrock's Performer Series carburetor is now available with a black powder coated finish with bright silver hardware, giving you a look that will set you apart from the crowd. Equipped with an electric choke for better cold starts.

All 600CFM w/ Electric Choke #16939..... \$433.95/ea.



EDELBROCK INTAKE MANIFOLD GASKETS

Edelbrock gaskets feature an embossed silicone bead around the ports for a clean positive seal. End seals not included. We recommend using RTV silicone.

All SB exc. Vortec or E-Tec Heads #13106..... \$18.95/set



ACCELERATOR PUMP ASSEMBLIES

All 500-650 CFM Performer Carburetors	#13234.....	\$13.95/set
All 750 CFM Performer Carburetors	#13235.....	\$10.95/set

EDELBROCK RPM DUAL QUAD AIR-GAP MANIFOLD AND CARBURETOR KITS

Edelbrock's RPM Dual Quad Air Gap manifold and carburetor kit provides everything needed to convert from single carburetor to dual-quad set up for small block Chevy's. Kit includes the new Dual Quad Air Gap manifold, two Thunder AVS 500cfm carburetors (one manual, one electric choke), high tech progressive linkage, fuel line and intake gaskets.

1955-86 SB, Endurashine	#14056.....	\$1641.95/kit
1986-95 SB, Endurashine	#14057.....	\$1565.95/kit
All BB, Endurashine	#15131.....	\$1697.95/kit



EDELBROCK SINGLE QUAD MANIFOLD AND CARBURETOR KITS WITH ENDURASHINE FINISH

Edelbrock's Single-Quad manifold and carburetor kits with Endurashine finish provide you with everything needed to install an aluminum manifold and carburetor on your classic Chevy. Each kit includes: Intake manifold and either Performer or Thunder AVS carburetor with Endurashine finish, fuel line, Gasgacinch, intake bolts and gaskets.

1957-86 SB, Performer EPS w/ Performer 600	#14293.....	\$830.95/kit
1957-86 SB, Performer Air Gap w/ Performer 600	#14294.....	\$895.95/kit
1957-86 SB, Performer RPM Air Gap w/ Thunder AVS 800	#14295.....	\$1004.95/kit
All SB, Vortec Performer w/ Thunder AVS 650	#14297.....	\$884.95/kit
All SB, Vortec RPM Performer Air Gap w/ Thunder AVS 800	#14299.....	\$1059.95/kit
All BB, Oval Port Performer, w/ Thunder 800	#14300.....	\$1014.95/kit
All BB, Oval Port RPM Air Gap, w/ Thunder AVS 800, Performer	#14302.....	\$1050.95/kit

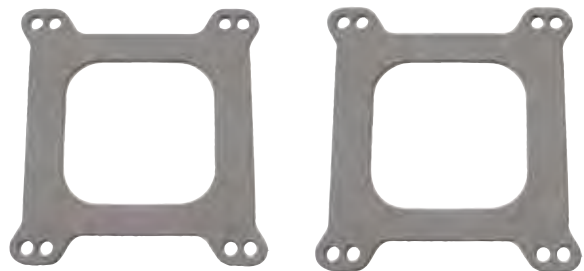

EDELBROCK CARBURETOR BASE GASKETS

All.....	#14731.....	\$10.95/pr.
----------	-------------	-------------



TAPERED PORT CARB ADAPTER

All Large Square Bore to Small Square Bore, 4BC
 #13424..... \$33.95/ea.



EDELBRÖCK CARBURETOR ADAPTER PLATE

Part #13353 mounts to original Q-Jet manifold.
 All Spread Bore to Square Bore, .850" Thick
 #13353..... \$25.95/ea.



HEAT INSULATOR CARBURETOR GASKETS

Heat insulator gaskets help prevent fuel percolation by insulating the carburetor from excess engine heat. Use divided version for dual plane and open for open plane manifolds.

All Open Bore #13698..... \$22.95/ea.
 All Divided Bore..... #13699..... \$20.95/ea.



EDELBRÖCK CARBURETOR REBUILDING KIT

For all square bore carburetors.
 All..... #13231..... \$40.95/ea.

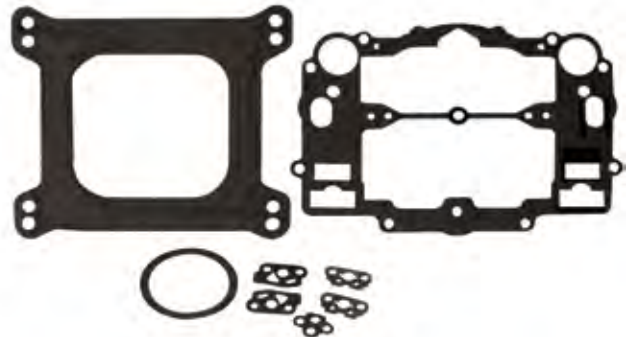

EDELBRÖCK CARBURETOR-TO-MANIFOLD AND AIRHORN GASKETS

All..... #14730..... \$13.95/set

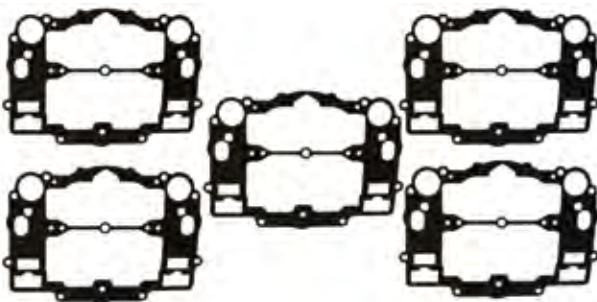

EDELBRÖCK CARBURETOR AIRHORN AND BASE GASKETS

All 5-Piece #17225..... \$16.95/ea.

EDELBROCK CARBURETOR CALIBRATION KITS

All calibration kits include an assortment of metering rods and jets, one pair of metering rod retaining springs and a complete assortment of step-up springs.



- EDL #1486 #17216.....\$63.95/kit
- EDL #1479 #17217.....\$69.95/kit
- EDL #1487 #17218.....\$46.95/kit
- EDL #1480 #17219.....\$65.95/kit
- EDL #1489 #17220.....\$53.95/kit
- EDL #1840 #17221.....\$60.95/kit
- EDL #1841 #17222.....\$75.95/kit
- EDL #1842 #17223.....\$61.95/kit



EDELBROCK THROTTLE SOLENOID AND BRACKET

All..... #13356.....\$176.95/kit



EDELBROCK HARDENED STEEL PUSHRODS

Part #13145 is for use with Performer RPM heads and is + .100 longer than stock.

All SB, 5/16" Diameter #13145..... \$136.95/set



EDELBROCK STEP UP SPRING ASSIST

Step up springs are key to fine tuning the "Power Mode" of your Edelbrock carburetor to your specific needs. Includes 3" Hg (blue), 4" Hg (yellow), 5" Hg (orange), 7" Hg (pink) and 8" Hg (plain) springs.

All 5 Pairs of Springs #13233..... \$9.95/set



EDELBROCK CYLINDER HEAD GASKET SET

All SB..... #13140..... \$99.95/ea.



EDELBROCK AND CARTER AFB CARB BANJO FITTING

All 3/8" #18673..... \$11.95/ea.



EDELBROCK TRIPLE DEUCE FUEL LOG KIT

This fuel log kit is an exact replica of the original design used by Vic Senior in the 1950's. Kit includes black neoprene hose, Corbin style hose clamps, barb fittings, a pipe plug and a period correct Edelbrock decal for the right look.

All..... #16937.....\$91.95/kit

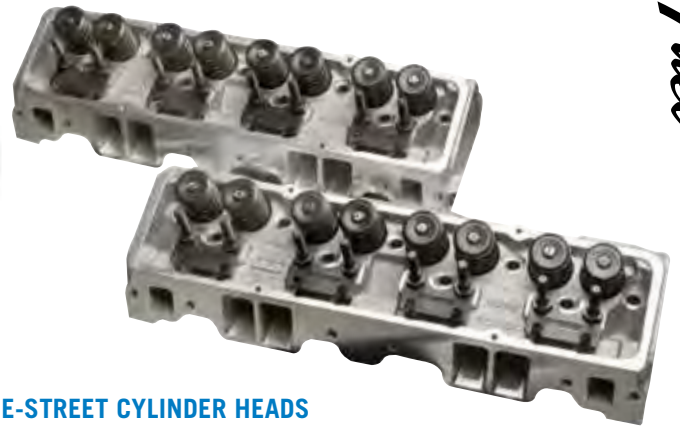

EDELBROCK E-210 E-STREET CYLINDER HEADS

The E-210 cylinder head for small-block Chevy engines provides race-level performance while maintaining full compatibility with OEM equipment. It features larger runners for increased airflow, revised exhaust ports and larger diameter springs for higher lift camshafts, making them ideal for a spec series racer and larger displacement engines. The exhaust port flange is in the stock location to allow for the use of off-the-shelf headers and hardware, while the enlarged valves and ports support the power needed to compete at engine speeds of up to 6500 rpm. The E-210 cylinder head is capable of supporting more than 500 naturally aspirated horsepower, and even more in forced induction applications. Sold in pairs. **Made in the USA.** For hydraulic flat tappet and Hydraulic Roller applications.

All Hyd Flat Tappet..... #16475....\$1362.95/pr.
All Solid or Roller Tappet #16476....\$1420.95/pr.

E-STREET CYLINDER HEADS

E-Street cylinder heads are an all new line of Edelbrock heads designed for entry-level street performance engines, ideal for operating in the idle to 5,500 RPM range. Manufactured in the USA, by Edelbrock, these heads feature A356 aluminum castings that are heat treated to T-6 spec for superior casting strength and quality. Their modern combustion chamber designs improve the combustion process and larger than stock intake and exhaust ports move more air through your engine. These features improve an engine's efficiency, resulting in more horsepower and torque and improved mileage potential.

All 70CC, 86 & Earlier SB #15638.....\$950.95/pr.
All 64CC, 86 & Earlier SB #15639.....\$969.95/pr.

EDELBROCK PERFORMER RPM CYLINDER HEADS

Designed for emission legal 302-400 c.i. engines. These heads are straight plug, have 2.02 intake valves, 1.60 exhaust valves, 64 or 70 CC combustion chambers and made 420HP with the Performer RPM power package. Be sure to order head gaskets and the correct head bolt kit. Hardened pushrods are required. RPM series heads do not have an exhaust crossover. **Made in the USA.**

1955-57 SB w/ Straight Plugs, 70 CC
 #13128..... \$736.95/ea.
1955-57 SB w/ Straight Plugs, 64 CC
 #13129..... \$713.95/ea.

EDELBROCK PERFORMER SMALL BLOCK CYLINDER HEADS

Designed for emission legal 302-400 c.i. engines featuring an exhaust crossover for emissions compatibility. Performer heads provide outstanding street performance. Be sure to order head gaskets and the correct head bolt kit. Hardened pushrods are required. **Made in the USA.**

All 70 CC..... #13130..... \$825.95/ea.
All 64 CC..... #13131..... \$831.95/ea.



EDELBROCK CYLINDER HEAD BOLTS

Edelbrock head bolt kits contain a complete set of the highest quality head bolts and washers available. A must have when switching from cast iron to aluminum heads.

All SB..... #13138..... \$153.95/kit



#13092

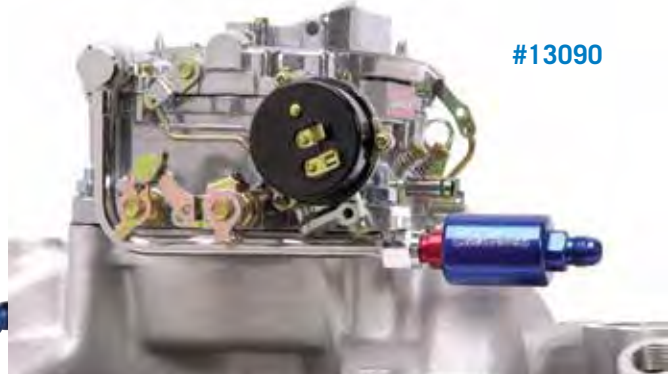

#13090

EDELBROCK FUEL LINES

All Single Feed w/ Polished Aluminum Filter, 40 Micron.....	#13089.....	\$40.95/ea.
All Single Feed w/ Blue Anodized Filter, 40 Micron.....	#13090.....	\$38.95/ea.
All Single Feed w/ 3/8" Barbed Outlet, w/o Filter.....	#13091.....	\$24.95/ea.
All Dual Feed w/ Blue Anodized Filter, 40 Micron.....	#13092.....	\$94.95/ea.
All Dual Feed w/ Polished Aluminum Filter, 40 Micron	#13093.....	\$84.95/ea.
All Dual Feed w/ 3/8" Barbed Outlet, w/o Filter.....	#13094.....	\$81.95/ea.



EDELBROCK HOSE KITS

All Fuel Pump to Regulator, 22", Braided Steel, SB*	#13102.....	\$62.95/kit
All Fuel Pump to Regulator, 27", Braided Steel, BB*	#13103.....	\$65.95/kit
All Fuel Pump to Carburetor, Braided Steel, SB**	#13104.....	\$39.95/kit
All Fuel Pump to Carburetor, Braided Steel, BB*	#13105.....	\$44.95/kit

*Note: For use with Edelbrock single and dual feed fuel line kits.

** Note: Goes from pump to filter assemblies.



EDELBROCK PRO-CLASSIC FUEL LINES

All SB, Black	#14728.....	\$39.95/kit
All BB, Black	#14729.....	\$54.95/kit



EDELBROCK FUEL FILTERS

Filters use -6AN fittings and have replaceable elements (40 microns), part #13088.

All High Flow, 40 Micron, Polished Aluminum	#13086.....	\$32.95/ea.
All High Flow, 40 Micron, Blue Anodized	#13087.....	\$29.95/ea.

EDELBROCK REPLACEMENT FUEL FILTER ELEMENT

For use with filters #13086 and #13087.

All 40 Micron	#13088.....	\$6.95/ea.
---------------------	-------------	------------



EDELBROCK ELECTRIC CHOKE KIT

This kit has everything you need to convert your manual choke Performer Series carburetor to an all season reliable electric choke.

All..... #13232..... \$74.95/kit



EDELBROCK RPM SERIES FUEL PUMPS

RPM Street Series billet aluminum mechanical fuel pumps are for high performance street applications. The 3/8" inlet and outlet offers increased flow over most other street fuel pumps, and the base clock position can be rotated to allow for various fuel line configurations. RPM Series fuel pumps will produce 6 psi and flow 110 gph. You will not need a fuel pressure regulator with this pump and it is designed for use with gasoline only.

All SB..... #13095..... \$135.95/ea.

All BB..... #13096..... \$152.95/ea.

EDELBROCK VICTOR SERIES FUEL PUMPS

Victor Series billet aluminum mechanical fuel pumps are for high performance racing applications. The 5/8" -18 inlet and outlet come with -8AN fittings installed to provide increased flow over street fuel pumps, and the base clock position can be rotated to allow for various fuel line configurations.

These pumps include a variety of additional inlet/outlet fittings including -6AN, inverted flare and 3/8" NPT, plus a copper crush washer for a leak-proof connection. Victor fuel pumps will produce 8.5-9 psi and will require the use of a fuel pressure regulator, such as Danchuk # 13100 shown on page 344. They will work with both gasoline and alcohol. Victor Series requires a fuel pressure regulator.

All SB..... #13097..... \$132.95/ea.

All BB..... #13098..... \$139.95/ea.



QUIET-FLO FUEL PUMPS

This pump features an aluminum housing with high quality internals that makes it durable but 4 to 14 dB quieter than the competition. Part #13350 requires no regulator.

All 120 GPH @ 6.5 PSI #13350..... \$209.95/ea.



WEATHERPROOF FUEL PUMP RELAY KIT

All..... #14614..... \$59.95/ea.



EDELBROCK UNIVERSAL EFI SUMP FUEL KIT

This Universal Sump Fuel Kit is designed to provide the necessary high fuel pressure required for EFI applications in vehicles equipped with an existing low pressure carbureted fuel system. This is a complete self-contained system that can be easily installed under the hood. The unique design of this system allows it to deliver a constant fuel pressure with no fuel return line, external fuel pressure regulator or fuel tank modifications. It is compatible with the existing factory fuel tank and pump, and is ideal for use with various aftermarket EFI systems and with many popular engine swap applications that require constant 35-90 psi fuel pressure. This Fuel Sump Kit features a new compact design that is adjustable from 35 to 90 psi and includes a vacuum reference port. This kit includes a durable molded, lightweight plastic fuel sump tank with high pressure fuel pump installed, wiring harness, universal mounting brackets, hose, fittings and all of the necessary hardware for installation.



All 105 GPH #18775..... \$499.95/kit



EDELBROCK CARBURETOR FUEL PRESSURE REGULATORS

- All 160 GPH, 5-10 PSI, Red..... #18463.....\$97.95/pr.
- All 160 GPH, 5-10 PSI, Blue..... #18464.....\$100.95/pr.
- All 160 GPH, 5-10 PSI, Black..... #18465.....\$97.95/pr.



EDELBROCK FUEL PRESSURE REGULATOR

All Adjustable, Regulator Only #13100..... \$79.95/ea.



QUICK DISCONNECT EFI FITTINGS

Use these fittings with part #17964 to convert the OE fittings to -6AN for easy hookup.

- All -6AN Male x 3/8 Female..... #17965..... \$12.95/ea.
- All -6AN Male x 3/16 Female..... #17966..... \$11.95/ea.
- All -6AN Male x 3/8 Male..... #17967..... \$7.95/ea.



LS ENGINE FUEL FILTER/REGULATOR

Make your LS engine swap easier with the fuel filter regulator combination. It can be used on other EFI applications that require 50 PSI. Be sure to order the quick disconnect fittings part #17965, #17966 or #17967 to make set up a breeze.

All..... #17964..... \$54.95/ea.



EDELBROCK PRO FLO 4 EFI KITS

Edelbrock Pro-Flo 4 EFI systems are equipped with the latest technology and features. The system comes complete with a traditional 4150-style single plane intake manifold and 29 lb/hr injectors capable of 550 HP. Also included is a plug and play single connection distributor designed to work specifically with Pro-Flo 4 and a made in the USA fully terminated high-quality harness with clearly labeled connections to ensure a hassle-free installation. Pro-Flo 4 EFI systems feature an all-new ECU with a faster processor, a water proof design and measures half the depth of the previous ECU. The key to the system is the Edelbrock exclusive E-Tuner 4 app with dyno developed base calibrations. The E-Tuner 4 app uses a Bluetooth wireless connection to communicate with the ECU's self-learning capability to continually adjust the calibration to get maximum performance. The E-Tuner 4 features a simple and easy to use setup wizard to help you get started and best of all, the E-Tuner 4 app allows you to use your personal Android based smart phone or tablet. Multiple dash displays are included to allow you to monitor engine vitals from your Android smart phone or tablet. No computer is necessary.

All 86-Earlier Small Block, 550HP.....	#19063.....	\$1795.95/kit
All 86-Earlier Small Block, 550HP, w/o Tablet.....	#19064.....	\$1695.95/kit
All BB Oval Port, 625HP.....	#19065.....	\$1895.95/kit
All BB Oval Port, 625HP, w/o Tablet.....	#19066.....	\$1795.95/kit
All LS Gen 3/4, Cathedral Port.....	#19067.....	\$1895.95/kit
All LS Gen 3/4, Cathedral Port, w/o Tablet.....	#19068.....	\$1795.95/kit
All LS Gen 3/4, Rectangle Port.....	#19069.....	\$1895.95/kit
All LS Gen 3/4, Rectangle Port, w/o Tablet.....	#19070.....	\$1795.95/kit

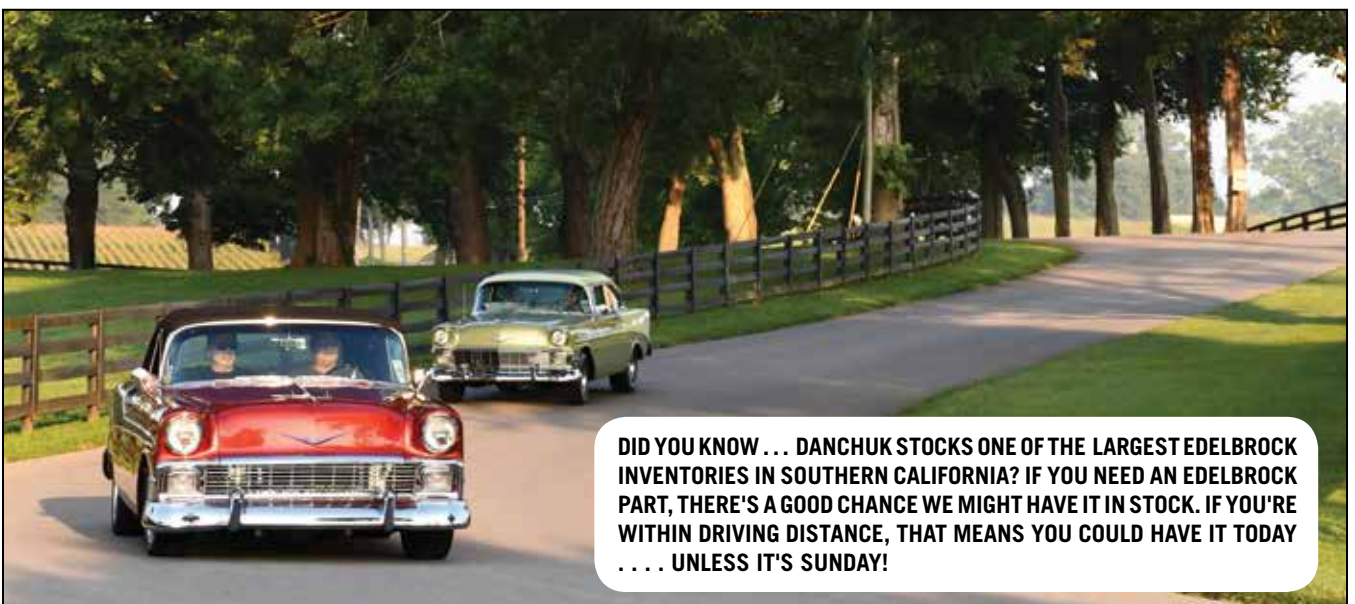

DID YOU KNOW . . . DANCHUK STOCKS ONE OF THE LARGEST EDELBROCK INVENTORIES IN SOUTHERN CALIFORNIA? IF YOU NEED AN EDELBROCK PART, THERE'S A GOOD CHANCE WE MIGHT HAVE IT IN STOCK. IF YOU'RE WITHIN DRIVING DISTANCE, THAT MEANS YOU COULD HAVE IT TODAY . . . UNLESS IT'S SUNDAY!



EDELBROCK EFI RETURN STYLE FUEL SYSTEM

Return Style Fuel Kits include everything needed to upgrade a carbureted fuel system to a high pressure EFI system, excluding the fuel tank. This kit is a return-style and will complete the fuel system loop by returning unused fuel to the tank. Kit includes a 57 GPH (215 liter/hr) fuel pump, adjustable regulator, filter, Russell Twist-Lok hose, hose ends, mounting brackets and hardware. A baffled fuel tank is recommended to prevent fuel starvation. This system is rated for engines up to 600 HP, when used with an E-Street EFI system.

All..... #17828..... \$586.95/ea.

**OE FUEL INJECTION
MAIN LINE FUEL
SHUT OFF SOLENOID**

This electric fuel shut-off solenoid is a safety feature that protects against hydraulic compression damage. The solenoid is aircraft style for gasoline usage and is installed under the plenum. Necessary for all 1957-1958 units and 1959 4900 and 7300 units. It is recommended you add one of these on all fuel injection units.

1957-62 #18944..... \$89.95/ea.



REPLACEMENT FUEL INJECTION FUEL MODULE

This is a complete replacement fuel module for the Danchuk #14947 and #14948 OE style performance fuel injection gas tanks. You get the hangar and sender assemblies along with the strainer, float and wiring harness. You will need a fuel pressure regulator to run this pump, sold separately.

1955-57 #18771..... \$249.95/ea.



REPLACEMENT FUEL INJECTION FUEL PUMP

For tanks #14947 or #14948.

All..... #17834..... \$49.95/ea.



Photo courtesy of GERTMAN2000

MSD ATOMIC EFI MASTER KIT WITH PUMP

The Atomic EFI Master kit includes every component you need to complete an EFI conversion. Kit includes: throttle body, power module, wide band O2 sensor, handheld programmer and a fuel pump that supports up to 525HP. Return line not required.



All..... #16902..... \$2477.95/kit



MSD ATOMIC EFI THROTTLE BODY KIT

If you have a car that already uses a high-pressure fuel pump with a return line then this kit provides the parts to convert to Atomic Power. Kit includes: throttle body, power module, wide band O2 sensor and a handheld programmer.

All..... #16903..... \$2214.95/kit



MSD ATOMIC EFI HIGH HP FUEL PUMP KIT

For engines from 525-650HP. Kit includes PWM fuel pump, pre and post filters, 15 feet of 3/8-inch fuel line and mounting hardware.

All..... #16904..... \$624.95/kit



MSD ATOMIC EFI INSTALLATION KIT

The MSD Atomic EFI install kit for LS1/6 is an add on kit which provides the wiring necessary to install the EFI Master Kit for LS2/3 on any LS1/6 application. Supplied in the kit are the different brackets for the rail assemblies as well as the different injector connectors to adapt the LS2/3 master kit to the LS1/6 intake manifold.

All LS1/LS6 #17812..... \$189.95/kit



Photo courtesy of GERTMAN2000

PAINLESS
Performance Products

FUEL INJECTION

FUEL INJECTION WIRE HARNESSES

Those who choose to run the factory ECM will appreciate the simplicity of a Painless fuel injection wire harness. You can try to make the stock harness work, but why complicate things? Painless has worked out all the potential problems, so all you have to do is follow the instructions and you're on your way. Every wire is labeled for ease of installation.



2000-2002 Gen III V8 w/ Electric Throttle.....	#15114.....	\$899.95/ea.
2003-06 4.8-6.0L.....	#17419.....	\$749.95/kit
2006-08 LS2/LS3/LS7, w/ 4L60E/65E	#17421.....	\$799.95/kit
2007-Up Gen IV w/ 4L65-85E Transmission	#17422.....	\$856.95/kit



MSD ATOMIC LS COIL COVER KITS

Clean up your LS engine swap with these coil-covers from MSD. Designed to work with MSD's Atomic LS EFI kits, but can be made to work along with minor modifications.

All Red.....	#17807.....	\$159.95/kit
All Black.....	#17808.....	\$175.95/kit
All Unfinished	#17809.....	\$175.95/kit



1957 FUEL INJECTION VENT LINE

This vent line runs from the fuel meter to the air cleaner.

1957.....	#2192.....	\$19.95/ea.
-----------	------------	-------------



1957 FUEL INJECTION FUEL FILTER BRACKET STUDS

These are the two special studs with threaded heads that screw into the intake so you can attach the fuel filter on factory Fuel Injection cars. Comes complete with the nuts and star style lock washer. Sold as a pair.

1957 with Nuts.....	#18933.....	\$24.95/pr.
---------------------	-------------	-------------



1957 FUEL INJECTION AIR CLEANER BRACKET

This is the bracket that installs between the center bolt on the fuel injection air cleaner assembly center bolt on the inside and the water outlet bolt that supports the fuel injection air cleaner.

1957 F.I.	#1301.....	\$15.95/ea.
----------------	------------	-------------



Note: All exhaust systems on this page are drop shipped from the supplier. Due to the size of the exhaust kits, shipping charges are approximately \$175.00 and available to ship to the contiguous 48 US states ONLY. No shipping to Alaska or Hawaii or international. ALL EXHAUST SYSTEMS ON THIS PAGE CAN TAKE 4-6 WEEKS DELIVERY.

ALUMINIZED EXHAUST SYSTEMS O/S

Our aluminized exhaust systems are made from heavy 16 gauge steel tubing with mufflers aluminized inside and out. All tailpipes are notched at the tips like the original. System sets include the exhaust header pipes and two header pipe flange gaskets as required. No kinks in bends, no flat spots, and correct fit of pipes every time. The results are a better looking, better performing, better flowing exhaust. All exhaust systems are oversized and will have additional shipping charges. If you've used our shock support upgrade (#950), you can special order any of the exhaust systems "modified" to fit properly. Kits do not include hangers or clamps. These exhaust systems **require** the use of a heat riser valve or heat riser spacer to insure proper fit. See page 359 for exhaust clamp and hanger kits

1955 6-Cyl. Hardtop & Sedan, Single	#2716.....	\$249.95/kit
1955 6-Cyl. Convertible, Single.....	#2717.....	\$249.95/kit
1955 6-Cyl. 6-Passenger Wagon, Single.....	#2718.....	\$249.95/kit
1955 V8 2BC Hardtop & Sedan, Single.....	#2719.....	\$349.95/kit
1955 V8 2BC Convertible, Single	#2720.....	\$349.95/kit
1955 V8 2BC 6-Passenger Wagon, Single	#2721.....	\$349.95/kit
1956 6-Cyl. Hardtop & Sedan, Single	#2725.....	\$249.95/kit
1956 6-Cyl. Convertible, Single.....	#2726.....	\$249.95/kit
1956 6-Cyl. 6-Passenger Wagon, Single.....	#2727.....	\$249.95/kit
1956 V8 2BC Hardtop & Sedan, Single	#2728.....	\$349.95/kit
1956 V8 2BC Convertible, Single	#2729.....	\$349.95/kit
1956 V8 2BC 6-Passenger Wagon, Single	#2730.....	\$349.95/kit
1957 6-Cyl. Hardtop, Sedan, Single.....	#2734.....	\$249.95/kit
1957 6-Cyl. Convertible, Single.....	#2735.....	\$249.95/kit
1957 6-Cyl. 6-Passenger Wagon, Single.....	#2736.....	\$249.95/kit
1957 V8 2BC Hardtop & Sedan, Single.....	#2737.....	\$349.95/kit
1957 V8 2BC Convertible, Single	#2738.....	\$349.95/kit
1957 V8 2BC 6-Passenger Wagon, Single	#2739.....	\$349.95/kit
1955 V8 4BC Hardtop & Sedan, Dual.....	#2722.....	\$499.95/kit
1955 V8 4BC Convertible, Dual	#2723.....	\$499.95/kit
1955 V8 4BC 6-Passenger Wagon, Dual	#2724.....	\$499.95/kit
1956 V8 Dual 4BC HT, Sedan & Convertible, Dual	#10852.....	\$499.95/kit
1956 V8 4BC Hardtop, Sedan & Convertible, Dual	#2731.....	\$499.95/kit
1956 V8 4BC 6-Passenger Wagon, Dual (Shown)	#2733.....	\$499.95/kit
1957 V8 4BC Dual 4BC, F.I., Ht & Sedan, Dual	#2740.....	\$499.95/kit
1957 V8 4BC & F.I. Conv., Dual	#2741.....	\$499.95/kit
1957 V8 4BC Dual 4BC & FI 6-Psngr Wgn. Dual	#2742.....	\$499.95/kit

DUAL TURBO STAINLESS EXHAUST SYSTEMS O/S

Rams horn exhaust systems require the use of a heat riser valve or heat riser spacer to insure proper fit. Steel hanger kit included. Stainless steel hangers not available. All turbo exhaust systems exit straight back and have two-piece tailpipes. All exhaust systems are oversized and will have additional shipping charges.

1955-57 Fits all SB w/ Rams Horn Exhaust Manifold	#2743.....	\$489.95/kit
1955-57 2-1/2" w/ Rams Horn Man., SB Only	#10156.....	\$549.95/kit
1955-57 2-1/2" w/ Header Exhaust, SB or BB	#10157.....	\$499.95/kit

STAINLESS EXHAUST SYSTEMS (NOT SHOWN) O/S

These exhaust systems **require** the use of a heat riser valve or heat riser spacer to insure proper fit.

1955 6-Cyl. Hardtop & Sedan, Single	#2716S.....	\$549.95/kit
1955 6-Cyl. Convertible, Single.....	#2717S.....	\$549.95/kit
1955 6-Cyl. 6-Passenger Wagon, Single.....	#2718S.....	\$549.95/kit
1955 V8 2BC Hardtop & Sedan, Single	#2719S.....	\$724.95/kit
1955 V8 2BC Convertible, Single	#2720S.....	\$724.95/kit
1955 V8 2BC 6-Passenger Wagon, Single	#2721S.....	\$549.95/kit
1956 6-Cyl. Hardtop & Sedan, Single	#2725S.....	\$549.95/kit
1956 6-Cyl. Convertible, Single.....	#2726S.....	\$549.95/kit
1956 6-Cyl. 6-Passenger Wagon, Single.....	#2727S.....	\$549.95/kit
1956 V8 2BC Hardtop & Sedan, Single	#2728S.....	\$724.95/kit
1956 V8 2BC Convertible, Single	#2729S.....	\$724.95/kit
1956 V8 2BC 6-Passenger Wagon, Single	#2730S.....	\$724.95/kit
1957 6-Cyl. Hardtop & Sedan, Single	#2734S.....	\$549.95/kit
1957 6-Cyl. Convertible, Single.....	#2735S.....	\$549.95/kit
1957 6-Cyl. 6-Passenger Wagon, Single.....	#2736S.....	\$549.95/kit
1957 V8 2BC Hardtop & Sedan, Single	#2737S.....	\$724.95/kit
1957 V8 2BC Convertible, Single	#2738S.....	\$724.95/kit
1957 V8 2BC 6-Passenger Wagon, Single	#2739S.....	\$724.95/kit
1955 V8 4BC Hardtop & Sedan, Dual.....	#2722S.....	\$949.95/kit
1955 V8 4BC Convertible, Dual	#2723S.....	\$949.95/kit
1955 V8 4BC 6-Passenger Wagon, Dual	#2724S.....	\$949.95/kit
1956 V8 4BC HT, Sedan & Convertible, Dual	#10852S.....	\$949.95/kit
1956 V8 4BC Hardtop & Sedan, Dual.....	#2731S.....	\$949.95/kit
1956 V8 4BC 6-Passenger Wagon, Dual	#2733S.....	\$949.95/kit
1957 Fits all 1957 V8 4BC, Dual 4BC, Fuel Injection Hardtop & Sedan, Dual.....	#2740S.....	\$1195.95/kit
1957 Fits all 1957 V8 4BC, Fuel Injection Convertible, Dual	#2741S.....	\$1195.95/kit
1957 Fits all 1957 V8 4BC, Dual 4BC, Fuel Injection 6-Passenger Wagon, Dual	#2742S.....	\$1195.95/kit

DUAL TURBO ALUMINIZED EXHAUST SYSTEMS O/S

Just like our original style systems, our turbo dual exhaust systems are made of steel tubing with aluminized mufflers. Includes two exhaust header pipes, 2" balance pipe, two high flow aluminized turbo mufflers and two-piece tailpipes, and hanger kit. Rams horn exhaust systems require the use of a heat riser valve or heat riser spacer to insure proper fit. All turbo exhaust systems exit straight back. Can bolt up to all original styled hangers. (Please note: fits Hardtops and Sedan models only.) Steel hanger kit included. All exhaust systems are oversized and will have additional shipping charges.

1955-57 Fits all SB w/ Rams Horn Exhaust Manifold	#2743.....	\$489.95/kit
1955-57 2-1/2" w/ Rams Horn Man., SB Only	#10156.....	\$549.95/kit
1955-57 2-1/2" w/ Header Exhaust, SB or BB	#10157.....	\$499.95/kit

WARNING! Products on these pages may contain chemicals known to the State Of California to cause cancer and/or birth defects or reproductive harm. www.p65warnings.ca.gov

#12203



#14220



DOUG'S HEADERS O/S

Doug's Headers will fit D-port as well as most angle plug heads. They clear 605/500 steering boxes as well as most column shift automatics and feature 3/8" flanges and 16 gauge tubing. Parts #12206-12209 require that the factory transmission side mounts be removed from the frame for clearance, will not work with cast iron powerglides. Big Block applications only work with automatics. Parts #12202 and #12203 will not fit GM Fast Burner head part number 19300955 and sp350, sp383 and ZZ6 engines. Parts #12204 and #12205 will not clear 168-tooth flywheels. Parts #12206 and #12207 have 1-3/4" primaries.

TRI-Y DESIGN SMALL BLOCK HEADERS

1955-57 Bare..... #12202.....\$519.95/pr.
 1955-57 Hot Jet Coated #12203.....\$719.95/pr.

Tube Size	Collector Size	Port Shape	Auto Column Shift	Trans Floor Shift	Std. Column Shift	Trans Floor Shift
1-5/8	2-1/2	OVL	Y	Y	N	Y
Footnotes: 1, 2, 4, 5, 12 & 13						

FULL LENGTH, SMALL BLOCK HEADERS

1955-57 Bare, Auto #12206.....\$519.95/pr.
 1955-57 Hot Jet Coated, Auto..... #12207.....\$719.95/pr.

Tube Size	Collector Size	Port Shape	Auto Column Shift	Trans Floor Shift	Std. Column Shift	Trans Floor Shift
1-3/4	3	SAP	Y	Y	N	Y
Footnotes: 1, 2, 5, 7, 11, 12 & 13						

4-TUBE, SMALL BLOCK HEADERS

1955-57 Bare..... #12204.....\$519.95/pr.
 1955-57 Hot Jet Coated #12205.....\$719.95/pr.

Tube Size	Collector Size	Port Shape	Auto Column Shift	Trans Floor Shift	Std. Column Shift	Trans Floor Shift
1-5/8	2-1/2	OVL	Y	Y	N	Y
Footnotes: 1, 2, 3, 5, 12 & 13						

LS1/LS6 HEADERS

1955-57 Coated #14220.....\$729.95/pr.
 Oxygen sensor bungs welded on collectors.

Tube Size	Collector Size	Port Shape	Auto Column Shift	Trans Floor Shift	Std. Column Shift	Trans Floor Shift
1-7/8	3	SAP	Y	Y	N	N
Footnotes: 2, 3, 8, 9 & 10						

4-TUBE BIG BLOCK HEADERS

1955-57 Bare..... #12208.....\$519.95/pr.
 1955-57 Hot Jet Coated #12209.....\$719.95/pr.

Tube Size	Collector Size	Port Shape	Auto Column Shift	Trans Floor Shift	Std. Column Shift	Trans Floor Shift
2	3-1/2	SAP	Y	Y	N	N
Footnotes: 2, 6, 7, 13 & 14						

Footnotes:

1. Fit Angle Plug including Factory GM "Bowtie" Heads.
2. Fits 500/605 Steering Boxes.
3. Shortie Design.
4. Y indicates Tri-Y Design.
5. Fits D-Port and Z24 Motors.
6. Motor in Stock V8 Position Only.
7. Will not fit 4-Speed with factory trans mounts.
8. O² sensor bungs are installed.
9. LS1/LS6 must use LS1 oil pan.
10. Requires street & performance engine adapter.
11. Will not fit with Powerglide.
12. Fits motors in stock and no more than 3/4" forward.
13. Must use V8 Pitman Arm casting Danchuk #13870
14. Must remove factory transmission frame mounts.

**PLEASE CHECK HEADER CLEARANCE BEFORE MOUNTING.
 DAMAGED OR MODIFIED HEADERS CANNOT BE RETURNED.**

NOTE: SEE OUR WEBSITE FOR PHOTOS OF ALL HEADERS.



#12788



#12789



#12790

PATRIOT HEADERS O/S

Patriot headers feature heavy duty 16-gauge tubing, 3/8" flanges and come with metallic ceramic coating. All the Patriot headers that we offer are designed for **maximum ground clearance** for cars lowered as much as 4". Parts #12788, #12789 and #12790 will clear 605/500 box and will work with all Danchuk side mount kits.

SHORTIE SMALL BLOCK HEADERS

Must use 153-tooth flywheel or mini-starter. Will not fit angle plug heads.

1955-57 Coated #12788.....\$399.95/pr.

Tube Size	Collector Size	Port Shape	Auto Column Shift	Trans Floor Shift	Std. Column Shift	Trans Floor Shift
1-5/8	2-1/2	RD	Y	Y	N	N
Footnotes: 1, 2, 3, 5, 9, 12 & 18						

SHORTIE SMALL BLOCK HEADERS

1955-57 Jet Hot Coated #18840.....\$422.95/pr.

1955-57 Bare..... #18841.....\$245.95/pr.

Tube Size	Collector Size	Port Shape	Auto Column Shift	Trans Floor Shift	Std. Column Shift	Trans Floor Shift
1-5/8	2-1/4	D	Y	Y	N	Y
Footnotes: 2, 3, 4, 12, 16 & 18						

FULL LENGTH, SMALL BLOCK HEADERS

Will fit standard and auto transmission floor shift only. Fits angle plug heads and features 1-3/4" primary tubes. Requires factory transmission side mounts to be removed for clearance.

1955-57 Coated #12789.....\$589.95/pr.

Tube Size	Collector Size	Port Shape	Auto Column Shift	Trans Floor Shift	Std. Column Shift	Trans Floor Shift
1-3/4	3	REC	N	Y	N	Y
Footnotes: 4, 8, 10 & 12						

FULL LENGTH, BIG BLOCK HEADERS

Will fit automatic transmissions only. Fits standard deck big blocks only (396-502). Factory transmission side mounts will need to be removed for clearance.

1955-57 Coated #12790.....\$519.95/pr.

Tube Size	Collector Size	Port Shape	Auto Column Shift	Trans Floor Shift	Std. Column Shift	Trans Floor Shift
1-7/8	3	SAP	Y	Y	N	N
Footnotes: 2, 5, 6, 7, 11 & 12						

SHORTIE LS1/LS6 HEADERS

Fits 605 box, side mounts and crossmember. Will not clear 3-speed column shift.

1955-57 Coated, Shortie, LS1/LS6 #14120.....\$509.95/pr.

Tube Size	Collector Size	Port Shape	Auto Column Shift	Trans Floor Shift	Std. Column Shift	Trans Floor Shift
1-3/4	3	RD	Y	Y	N	Y
Footnotes: 2, 3, 6, 13, 14 & 15						

RACK & PINION SHORTIE HEADERS

#17375 is 1-7/8" tube size, 3" collector, SAP port shape, auto. transmission floor shift, standard floor shift.

1955-57 Raw, SB V8 #15405.....\$249.95/pr.

1955-57 Coated, SB V8 #15406.....\$445.95/pr.

1955-57 Coated, BB #17375.....\$690.95/pr.

Tube Size	Collector Size	Port Shape	Auto Column Shift	Trans Floor Shift	Std. Column Shift	Trans Floor Shift
1-5/8	3	REC	Y	Y	N	N
Footnotes: 1, 9, 16, 17, 18, 19 & 20						

Footnotes:

- Will not fit Angle Plug Heads.
- Fits 500/605 Steering Boxes.
- Shortie Design.
- Fits most Angle Port Heads.
- Check Motor Position.
- Motor Stock Location Only.
- Standard Deck Big Block Only.
- Floor Shifter Only.
- Will not fit 168 Tooth Flywheel or Kickout Starters.
- Fits motors 3/4" forward, mid-mount must be removed.
- Must Remove Mid Mounts.
- Fits only with V8 Pitman Arm Casting Danchuk #13870
- O² Bung are installed for sensors.
- LS1/LS6 Engines require LS1 oil pan.
- Requires Street & Performance Adapter.
- Mid Length Design.
- Will not work with D-Port Heads.
- Works with motor in stock or no more than 3/4" forward.
- Will not fit manual transmission hit factory cross shaft.
- Designed for Maval/Unisteer Rack-n-Pinion System.

PLEASE CHECK HEADER CLEARANCE BEFORE MOUNTING. DAMAGED OR MODIFIED HEADERS CANNOT BE RETURNED.



#13188

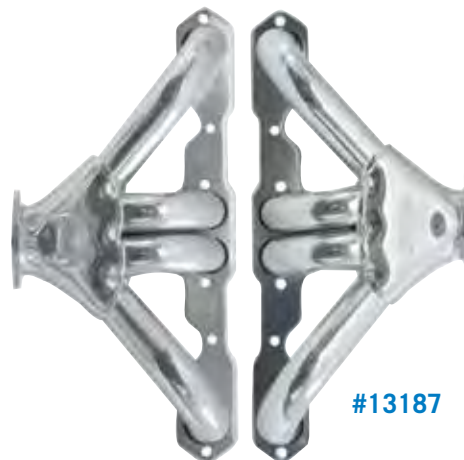

#13187

HEDMAN HEADERS O/S

Hedman has been making headers for 50 years. They use state of the art header design utilizing mandrel bent tubes. The Elite Series are made with heavy duty 14 gauge tubing, 3/8" flanges and have a satin finish Hi-Tech HTC ceramic coating. The D-Port style is specially designed for cylinder heads with D-Shaped exhaust ports and is HTC coated. D-Shaped on Tite Tube only. Tite-Tube headers offer the lowest profile for very tight engine compartments and feature a unique 4 into 1 collector and HTC coating, ideal for lowered cars. **NOTE: SEE OUR WEBSITE FOR PHOTOS OF ALL HEADERS.**

HEDMAN HEADERS - ELITE

Will clear 605/500 box and angle plug heads (Chevy Only). Must use parts #871, #871B or stock motor mounts. Will fit standard and auto transmissions, floor shift only.

1955-57 SB, Coated, Stock Location

..... #13185.....\$568.95/pr.

Tube Size	Collector Size	Port Shape	Auto Column Shift	Trans Floor Shift	Std. Column Shift	Trans Floor Shift
1-5/8	3	RD	N	Y	N	Y
Footnotes: 1, 4 & 5						

HEDMAN HEADERS - SHORTY SMALL BLOCK

Will clear 605/500 box and angle plug heads (Chevy Only). Must use parts #871, #871B or stock motor mounts. Will fit standard and auto transmissions, floor shift only.

1955-57 SB, Shorty Style, Painted

..... #13229.....\$254.95/pr.

1955-57 SB, Shorty Style, HTC Coated

..... #13230.....\$576.95/pr.

Tube Size	Collector Size	Port Shape	Auto Column Shift	Trans Floor Shift	Std. Column Shift	Trans Floor Shift
1-5/8	3	RD	N	Y	N	Y
Footnotes: 1, 2, 4 & 5						

Footnotes:

1. Fits 500/605 Steering Boxes
2. Shortie Design
3. Square Headers
4. Will fit angle port heads (Chevy Alum only)
5. Motor stock location only
6. Must use with 871, 871B, 12185
7. Must use mini starter

HEDMAN HEADERS - TITE TUBE SMALL BLOCK

Shorty style. Will clear 605/500 box. Small block version will clear column shift transmission. Big block version will not clear 3-speed column shift, and must use mini starter, see part #12892. 502 with aluminum heads; header flange may hit head bolts.

1955-57 SB, Tite Tube, Coated

..... #13187.....\$694.95/pr.

Tube Size	Collector Size	Port Shape	Auto Column Shift	Trans Floor Shift	Std. Column Shift	Trans Floor Shift
1-5/8	2-1/2	RD	Y	Y	Y	Y
Footnotes: 1, 2 & 4						

HEDMAN HEADERS - TITE TUBE BIG BLOCK

Shorty style. Will clear 605/500 box. Small block version will clear column shift transmission. Big block version will not clear 3-speed column shift, and must use mini starter, see part #12892. 502 with aluminum heads; header flange may hit head bolts.

1955-57 BB, Tite Tube, Coated

..... #13188.....\$689.95/pr.

Tube Size	Collector Size	Port Shape	Auto Column Shift	Trans Floor Shift	Std. Column Shift	Trans Floor Shift
2	3	SQ	Y	Y	N	Y
Footnotes: 2, 3, 6, 7, 8, 9 & 10						

8. Will need to modify the firewall
9. May need to notch flange at head bolts on 502 aluminum heads (Gen 6 Engines)
10. Without smog injection or injection heads.

PLEASE CHECK HEADER CLEARANCE BEFORE MOUNTING. DAMAGED OR MODIFIED HEADERS CANNOT BE RETURNED.

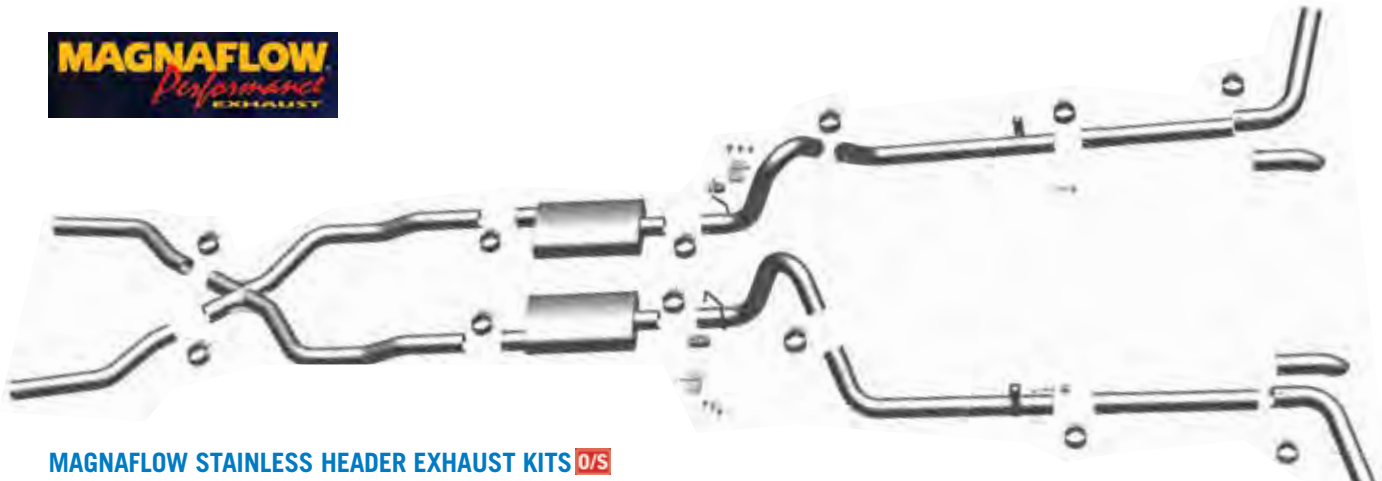

MAGNAFLOW STAINLESS HEADER EXHAUST KITS O/S

Magnaflow exhaust systems are dyno-tested and proven to make power, giving you performance gains in both horsepower and torque. All tubing is mandrel bent and built to last. Each kit comes with 4" x 8" x 14" dual mufflers, Tru-X pipe, either 2.5 or 3" systems with 2.5 or 3" polished turn down tips. Multiple DUAL REAR EXIT OPTIONS. Get great sound and smooth deep tone with this easy to install kit. Lifetime warranty. **Will not fit wagons or convertibles.**

1955-57 2.5", V8	#15915.....	\$712.95/kit
1955-57 3.0", V8, Polished Tips Not Included.....	#15916.....	\$782.95/kit

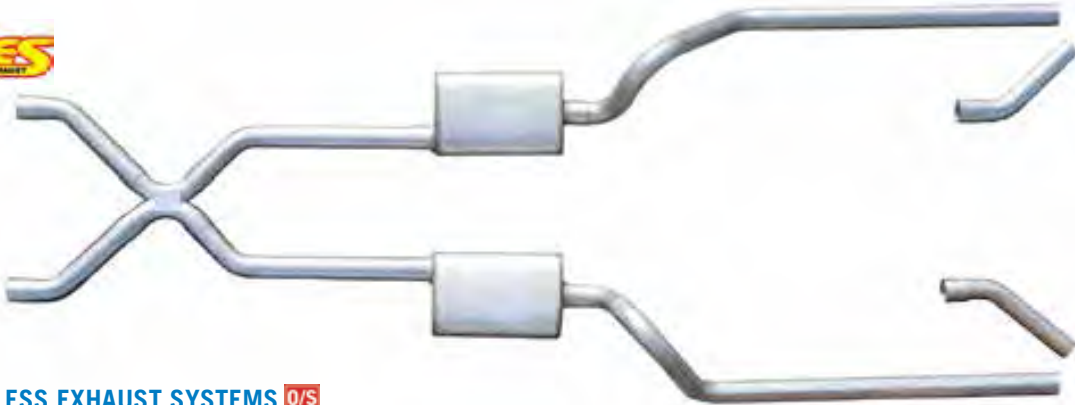

PYPES STAINLESS EXHAUST SYSTEMS O/S

Pypes exhaust systems are designed to deliver enhanced performance, provide extra punch in the passing lane and improve gas mileage. They are fabricated from 16 gauge, mandrel bent, stainless steel pipe which allows them to resist corrosion extending the life of the system and they are a slip fit design for ease of installation. The ultimate in sound and performance. It includes Street Pro or Race Pro mufflers and Pypes patented "X" crossover headpipe. Installation instructions included. **Wagon exhaust kits exit behind the rear wheels below quarter panel. NOTE: Part #19036 is designed for a pocket kit. This kit only works with a centered gas tank and with the spare tire well removed.**

1955-57 Street Pro, 2-1/2", exc. Nomad, Wagon & Convertible	#13518.....	\$524.95/set
1955-57 Street Pro, 2-1/2", exc. Nomad, Wagon & Convertible, For Leaf Spring Pocket Kit	#19036.....	\$519.95/kit
1955-57 Street Pro, 2-1/2", Nomad & Wagon	#16032.....	\$539.95/set
1955-57 Race Pro, 2-1/2", exc. Nomad, Wagon & Convertible.....	#19033.....	\$549.95/kit
1955-57 Race Pro, 3", exc. Nomad, Wagon & Convertible	#19034.....	\$549.95/kit
1955-57 Race Pro, 2-1/2", Nomad & Wagon.....	#19035.....	\$519.95/kit



LS EXHAUST MANIFOLDS

These ceramic coated cast iron block hugger style exhaust manifolds with head pipe adapters help make your LS conversion as easy as possible. Includes gaskets, headpipes and mating flanges.

All Silver (Shown).....	#19410.....	\$419.95/ea.
All Black	#19411.....	\$479.95/ea.



1956 EXHAUST MANIFOLDS

These "Rams Horn" type exhaust manifolds fit all 1956 Chevy passenger cars and Corvettes. They were designed just like the originals, right down to the correct GM casting numbers. Find the exhaust manifold bolts and washers on page 356. They will help you to complete the job.

1956, '56 Vette, 2"	#2237.....	\$539.95/pr.
---------------------------	------------	--------------



RAMS HORN EXHAUST MANIFOLDS

These replacement "Rams Horn" manifolds feature a 2-inch center exit design which allows it to be used on the driver side when the cast-in alternator bracket is not required. This manifold comes with flange studs and gasket, manifold gaskets, nuts and washers.

1955-57 2", Driver	#15553	\$89.95/ea.
1955-57 2", Passenger.....	#15554	\$135.95/ea.

EXHAUST MANIFOLD HEAT RISERS

The exhaust heat riser installs in the right exhaust pipe and is closed when the engine is cold. While closed it forces exhaust gasses up under the carburetor plenum helping with cold engine drivability. A coil and weight on the heat-riser flap allows the valve to flap open when the engine warms up.



1957-65 V8, 2"	#12728.....	\$79.95/ea.
1957-65 V8, 2-1/2"	#12729.....	\$85.95/ea.

1957 EXHAUST HEAT RISER SPACERS

Heat riser spacers are used in place of the heat riser valve when your needs don't require a shorter warm up period and you want maximum exhaust flow.



1957 2"	#12724.....	\$47.95/ea.
1957 2-1/2"	#12725.....	\$49.95/ea.



FLOWMASTER TAILPIPES O/S

Exits under rear bumper. Use with offset/center mufflers. Will not fit wagons.

All 2.5", Aluminized, exc. Wagons #12973..... \$189.95/pr.

ELECTRIC EXHAUST CUTOUT KITS

Nothing gets a gearhead excited like the sound of open headers and with these exhaust cutout kits you can go from muffled to open headers with a flip of a switch. Totally redesigned and made from 304 stainless, these feature a high torque 12 volt DC gear reduction motor with a self adjusting and self cleaning gate for a totally leak proof seal with zero obstructions when open. Kits include the cutouts, Y-pipe, stainless steel band clamps, wiring, gaskets and hardware.



All 2-1/2" #18733..... \$434.95/kit
 All 3" #18734..... \$447.95/kit
 All 2-1/2" Cut-Outs Only #18735..... \$369.95/pr.
 All 3" Cut-Outs Only..... #18736..... \$369.95/pr.

POWER STEERING HEAT SHIELDS

This power steering hose heat shields install around the exhaust pipe and keeps the hose from contacting the exhaust.



1955-57 Short Heat Shield #18905..... \$41.95/ea.
 1955-57 Long Heat Shield, V8, Single Exhaust #18906..... \$47.95/ea.

STAINLESS EXHAUST CUTOUT TURNDOWN

Made to accompany the Doug's electric exhaust cutout kits these 304 stainless steel exhaust turndowns allow you to route your exhaust flow away from the floor boards or in any direction you want. Stainless bands are included for a weld free leak proof attachment.



All 2-1/2" #18737..... \$35.95/ea.
 All 3" #18738..... \$39.95/ea.



EXHAUST HEAT RISER GASKETS

Everyone hates exhaust leaks in their classic. So if your heat riser is the leaky culprit stop the noise with this quality gasket. Mounts between the exhaust flange and the heat riser.

1957-Up 2-1/2" #16235..... \$1.95/ea.
 1957-65 V8, 2" #2197..... \$3.95/ea.



STEEL EXHAUST CLAMPS

1955-57 1-7/8" #10310...\$3.50/ea.
 1955-57 1-3/4" Crossover #10311...\$3.50/ea.
 1955-57 2" #10312...\$2.95/ea.
 1955-57 2-1/2" #10313...\$3.50/ea.



#2247

EXHAUST MANIFOLD BOLTS AND WASHERS

One set required per car.

- 1955-56 V8, '55 Vette #2247 \$22.95/set
- 1957-64 V8 #2261 \$24.95/set

EXHAUST RELATED

STAINLESS STEEL EXHAUST MANIFOLD WASHERS



These long-lasting stainless steel washers should be used in conjunction with our stainless steel exhaust manifold studs and our brass exhaust manifold nuts, part #2208, shown below.

- All #2194 \$9.95/set

BRASS EXHAUST MANIFOLD NUT

If your exhaust manifold nuts are steel, chances are they've fused together with the studs and washers. To prevent this from happening, use our brass exhaust manifold nut. The 1957 6-cylinder uses two nuts, the 1955 and 1956 V8's require four nuts, and the 1957 V8 needs six nuts.



- 1955-57 #2208 \$3.95/ea.



Photo courtesy of GERTMAN2000



FEL PRO EXHAUST MANIFOLD GASKET SET

These exhaust manifold gaskets are a direct replacement for your originals. Manufactured from compressed fiber with a steel core they guarantee a leak free seal and a perfect fit.

- 1955-96 SB #16215 \$9.95/set



EXHAUST MANIFOLD BOLT LOCKS

The regular heat-up and cool-down of the exhaust manifold will work those unprotected bolts loose. This hardware kit will aid in keeping the manifold bolts tight.

- 1955-56 V8, '55-56 Vette #1528 \$15.95/set
- 1957 V8, '57-'63 Vette (Shown) ... #1529 \$15.95/set



#17911

EXHAUST MANIFOLD FLANGE GASKETS

#16236

Everyone hates exhaust leaks in their classic. So if your exhaust flange is the leaky culprit stop the noise with these quality gaskets.

- 1955-56 Heat Riser to Mani., V8.. #17911 \$3.50/ea.
- 1955-57 2" Rams Horn #16236 \$3.76/ea.
- 1955-57 2-1/2" Rams Horn #16237 \$2.95/ea.



STAINLESS EXHAUST BAND CLAMPS

- All 2.5" x 1" #19031 \$9.95/ea.
- All 3" x 1" #19032 \$9.95/ea.



PYPES EXHAUST TIPS

- All 2-1/2", Stainless, 2" x 8" Rectangle #14304..... \$135.95/pr.
- All 3", Stainless, 2" x 8" Rectangle #14305..... \$139.95/pr.
- All 2-1/2", Stainless, 9" Angle Cut #14306..... \$39.95/pr.



POWER PACK EXHAUST EXTENSIONS

This stainless steel jewel is a beautiful way to finish your tailpipe, and the original design for the Power Pack drivetrain.

- 1955-56 V8 Dual..... #1291..... \$179.95/pr.

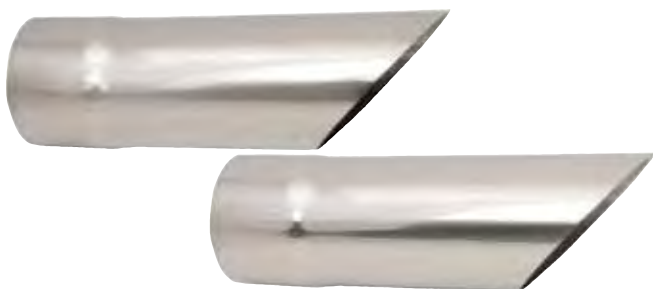

STAINLESS EXHAUST TIPS

- All 3" x 9"..... #19030..... \$44.95/pr.



3/4 VIEW

SIDE VIEW

FLOWMASTER EXHAUST TIP

All 2.25", Rolled Edge, Double Wall (Shown)

- #12969..... \$74.95/ea.

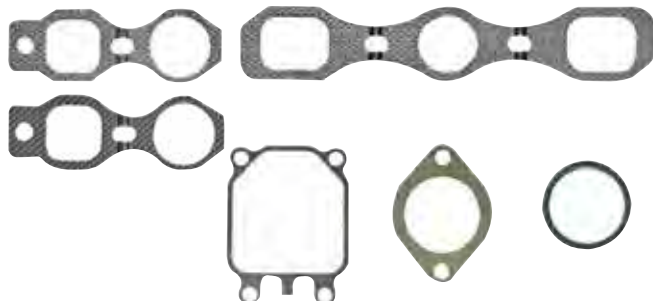

INTAKE/EXHAUST GASKET SET

- 1955-57 6-Cylinder..... #18134..... \$14.95/set



EXHAUST EXTENSION

This beautiful chrome plated accessory has all the detail and quality of the original with one exception: you won't have to search endlessly to find ours! Exhaust extensions eliminate discoloration of the rear bumper, and this one has an inner heat baffle to protect itself.

- 1955-56 V8 2 BC, 6-Cyl. Single ... #379..... \$38.95/ea.



CAM LOCK V8 HEADER BOLTS

- All SB 3/4" #17804..... \$29.95/set
- All BB 3/4" #17805..... \$35.95/set
- All SB 1" #17806..... \$31.95/set



SLIP-FIT STAINLESS EXHAUST TIPS

- All 2-1/2" #13611..... \$99.95/pr.
- All 3" #13612..... \$119.95/pr.



CHEVY ALUMINUM HEADER GASKET KITS

Proform's soft aluminum gaskets conform to the header flanges for a superior seal. Each kit comes with two gaskets.

All SB, Square Port	#16912.....	\$27.95/kit
All BB, Round Port	#16913.....	\$29.95/kit

MUFFLER AND TAILPIPE



ARP STAINLESS HEADER BOLTS

All SB, Hex	#14005.....	\$31.95/set
All SB, 12-pt.....	#14006.....	\$31.95/set
All BB, Hex	#14007.....	\$42.95/set
All BB, 12-pt.....	#14008.....	\$41.95/set
All LS, Hex, 3/8" Flange	#18234.....	\$69.95/kit
All LS, 12-pt., 3/8" Flange	#18235.....	\$75.95/kit

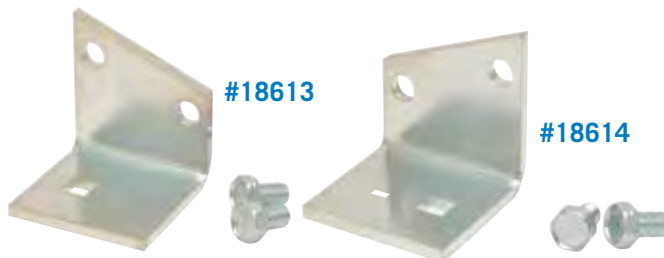

MUFFLER HANGER BRACKETS

These brackets are mounted directly to the car frame, just behind the muffler. In 1955, dual exhaust systems required a special bracket for the driver side, #2347. The other bracket, part #2348, is for the passenger side of all 1955 cars, and either side of 1956-57 cars with single or dual exhaust systems.



1955 w/ Dual Exhaust, Driver	#2347.....	\$8.95/ea.
1955 Passenger, '56-57, Either Side	#2348.....	\$7.95/ea.
1955-57 Driver, Stainless	#18613.....	\$17.95/ea.
1955-57 Passenger, Stainless.....	#18614.....	\$14.95/ea.



TAILPIPE HANGER BRACKETS

These brackets are mounted to the rear of the car's frame and support the tail pipe hangers.

1955 Driver.....	#2350.....	\$9.95/ea.
1955 Passenger	#2351.....	\$9.95/ea.
1955 Driver, Stainless	#18615.....	\$17.95/ea.
1955 Passenger, Stainless.....	#18616.....	\$14.95/ea.
1956-57 Either Side	#2356.....	\$9.95/ea.
1956-59 Either Side	#18617.....	\$14.95/ea.

MALLEABLE ALUMINUM COLLECTOR GASKET KITS

Proform's soft aluminum gaskets conform to the collector flanges for a superior seal. Each kit comes with two gaskets and six nuts and bolts.



All 2.5"	#16909.....	\$11.95/kit
All 3"	#16910.....	\$11.95/kit
All 3.5"	#16911.....	\$11.95/kit

REAR RUBBER MUFFLER HANGER

Why settle for inferior hardware when the original design is still available? The only way to mount a muffler is with a rubber muffler hanger.



1955-57	#860.....	\$12.95/ea.
---------------	-----------	-------------



MUFFLER/TAILPIPE HANGER REBOUND CLIP

This is the rebound clip that is used with muffler and tailpipe hangars. Used primarily on 1955-56 vehicles, it was also used on some early 1957 cars. It is used on 1955 models for the muffler hangar, on 1955-56 for the tailpipe hangar and on early 57's for both.

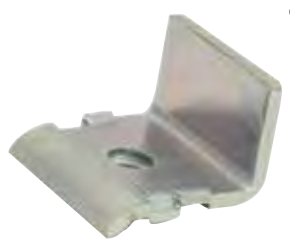

1955-57 #18607..... \$9.95/ea.

EXHAUST CLAMP AND HANGER KITS

Kits include everything from headpipe to tailpipe to install exhaust kits.

1955 6-Cyl.....	#19426.....	\$89.95/kit
1956 6-Cyl.....	#19427.....	\$89.95/kit
1957 6-Cyl.....	#19428.....	\$89.95/kit
1955 V8 Single.....	#19429.....	\$119.95/kit
1956 V8 Single.....	#19430.....	\$119.95/kit
1957 V8 Single.....	#19431.....	\$119.95/kit
1955 V8 Dual.....	#19432.....	\$179.95/kit
1956 V8 Dual.....	#19433.....	\$179.95/kit
1957 V8 Dual.....	#19434.....	\$179.95/kit

#18618



#18619

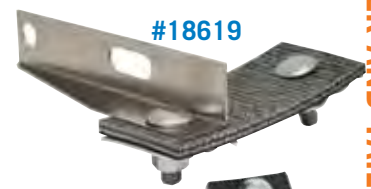

MUFFLER HANGERS

These assemblies, which support the muffler, are located just behind the muffler and are hung from the muffler hanger brackets. A rubber hanger strap is included with each muffler hanger. Fits 2-inch diameter exhaust.



#2346

1955-56 Either Side, Stainless.....	#18618.....	\$19.95/ea.
1957 Either Side, Stainless.....	#18619.....	\$19.95/ea.
1955-56 Either Side.....	#2344.....	\$26.95/ea.
1957 Either Side (Shown).....	#2346.....	\$24.95/ea.



#18609



#18610

TAILPIPE HANGERS

Our tail pipe hangers are part of the rear support of the tail pipe and are hung from the tail pipe hanger brackets. Tail pipe hangers listed here are sold individually and include a tail pipe clamp. Fits 2-inch diameter exhaust.

1956 Either Side.....	#2352.....	\$35.95/ea.
1957 Driver.....	#2354.....	\$32.95/ea.
1957 Passenger.....	#2355.....	\$32.95/ea.
1955 Either Side, Stainless.....	#18608.....	\$54.95/ea.
1956 Driver, Stainless.....	#18609.....	\$24.95/ea.
1956 Passenger, Stainless.....	#18610.....	\$19.95/ea.
1957 Driver, Stainless.....	#18611.....	\$54.95/ea.
1957 Passenger, Stainless.....	#18612.....	\$54.95/ea.



#18620



#18621



#18622

EXHAUST FLANGES

Exhaust flanges install over the exhaust pipe and the exhaust flange bolts go through them into the exhaust manifold to tighten the exhaust pipe to the manifold outlet.

1955-56 V8, 55-64 6-Cyl.	#18620.....	\$7.95/ea.
1957-64 3-Bolt, 2".....	#18621.....	\$3.95/ea.
1959-64 3-Bolt, 2-1/2".....	#18622.....	\$11.95/ea.



EXHAUST MANIFOLD STUDS WITH NUTS

1955-56 1-1/2", V8, Stainless	#18623.....	\$6.95/ea.
1957 3", 6-Cyl/V8, Passenger.....	#18624.....	\$8.95/ea.
1955-57 2 1/2", V8, Driver.....	#18625.....	\$6.95/ea.

WARNING! Products on these pages may contain chemicals known to the State Of California to cause cancer and/or birth defects or reproductive harm. www.p65warnings.ca.gov

Exhaust

INSULATION

The Original Exhaust Insulating Wrap™ was developed over 20 years ago by Thermo-Tec™. Exhaust insulating wrap is an innovative way to create more horsepower and reduce temperatures under the hood. Wrapping headers with exhaust insulating wrap maintains hotter exhaust gases that exit the system faster through decreased density. This produces increased exhaust scavenging, as well as lower intake temperatures. Exhaust insulating wrap withstands continuous heat up to 2000°F; it contains no asbestos. Thermo-Tec's exhaust wrap will not over-insulate a system when properly installed, due to its proprietary coating - Thermo-Conductive-Technology (T-C-T™), specially developed by Thermo-Tec, that conducts heat across the wrap's surface. This unique coating controls heat buildup and dissipation. Exhaust insulating wrap, available in neutral and graphite black, is sold in 50 ft. rolls both one and two inches wide. All exhaust wrap has a low profile of 1/16" thickness.



THERMO-TEC EXHAUST WRAPS

Using wraps voids most header manufacturers warranties. Reduces under hood temperature, increases power and efficiency and can withstand heat up to 2000 degrees. Increases the life of the engine and electronic components.

- All 1" x 50' #13060 \$28.95/ea.
- All 2" x 50' #13061 \$46.95/ea.



THERMO-TEC EXHAUST WRAPS

Thermo-tecs insulating exhaust wrap can withstand temperatures up to 2000 degrees and will not over-insulate when properly installed. Does not contain graphite.

- All Graphite Black, 2" x 50' #15641 \$52.95/ea.
- All Graphite Black, 1" x 50' #15640 \$33.95/ea.



THERMO-TEC SNAP STRAP KIT

Snap Straps are high-quality stainless steel straps with a dependable multi-lock system that are perfect for keeping the thermal wrap on your headers from coming loose. These narrow width straps are pre-cut to length and come with the multi locks pre-attached for ease of use, just insert the end and pull. Danchuk #13073 is a "V-8" kit that contains 8 - 9" straps and 4 - 18" straps.

- All 12 Straps #13073 \$32.95/kit

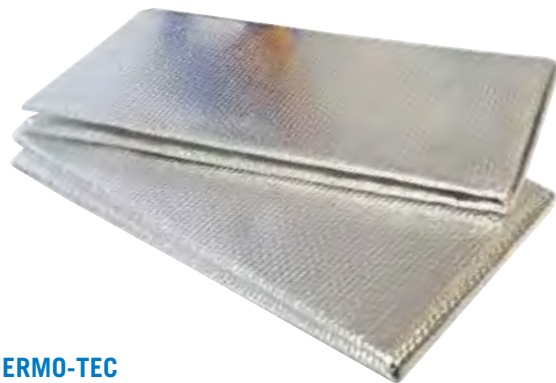

THERMO-TEC HEADER MANIFOLD BLANKET

The header manifold blanket provide excellent heat retention and simply attaches to the upper portion of the header/manifold. The aluminized surface faces out offering protection from abrasions and spills. Blankets measure 20" x 24" each.

- All V8 #15642 \$92.95/pr.

8. Heating & Cooling

SECTION AT A GLANCE:

Heater Cores	362
Heater Valves	363
Heater Related	364
Heater Hoses & Related	367
Thermostats	369
Fresh Air	370
Fan Shrouds.....	372
Fans.....	373
Radiators	376
Radiator Related.....	384
Air Conditioning	389



ALUMINUM DELUXE HEATER CORES

These aluminum deluxe heater cores are an alternative to the factory copper/brass originals. Fits just like the original. Will not fit standard heater systems.

1955-56	#17766.....	\$129.95/ea.
1957.....	#17767.....	\$129.95/ea.



NEW REPRODUCTION DELUXE HEATER CORES

These brand new copper/brass heater cores are a direct replacement for your rotted original. Will not fit standard heater systems. Don't forget a new heater valve, on page 363 to make sure you do the job right!

1955-56	#12407.....	\$208.95/ea.
1957.....	#12408.....	\$208.95/ea.



DELUXE HEATER CONTROL BEZELS

If you want to convert your car to deluxe heating, this bezel is an important part of the assembly. For restorers who are renewing their dash, a crisp reproduction is a more economical alternative to polishing and replating.

1955-56	#2557.....	\$99.95/ea.
1957.....	#11167.....	\$149.95/set

DELUXE HEATER ASSEMBLY FASTENERS

To properly finish a rebuilt heater assembly use these original design fasteners. All the clips, sheet metal screws, and machine screws to do the job right.



1955-56	#1036A.....	\$5.95/set
1957 (Shown)	#1036.....	\$5.95/set

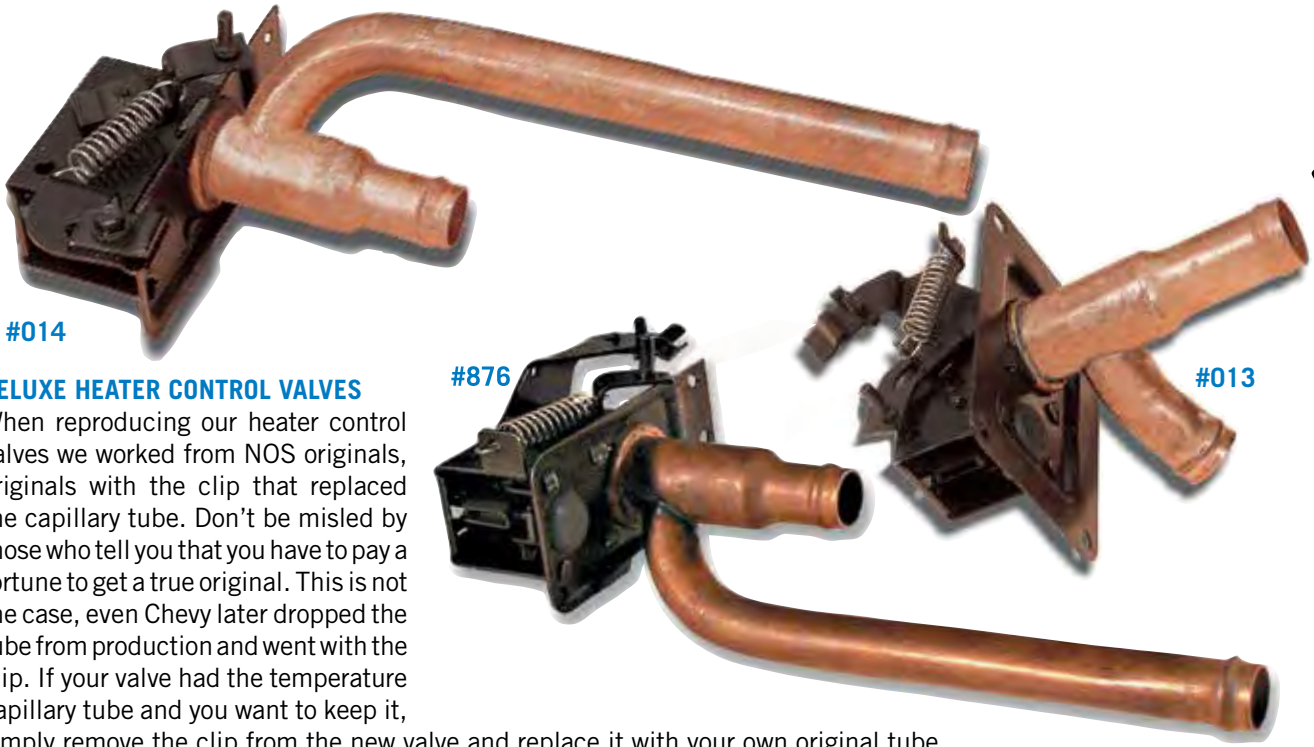

#014

DELUXE HEATER CONTROL VALVES

When reproducing our heater control valves we worked from NOS originals, originals with the clip that replaced the capillary tube. Don't be misled by those who tell you that you have to pay a fortune to get a true original. This is not the case, even Chevy later dropped the tube from production and went with the clip. If your valve had the temperature capillary tube and you want to keep it,

simply remove the clip from the new valve and replace it with your own original tube.

1955-56 Passenger Cars, 1955-58 Trucks	#014	\$74.95/ea.
1957 Passenger Cars	#013	\$74.95/ea.
1958-62 Corvette	#876	\$74.95/ea.

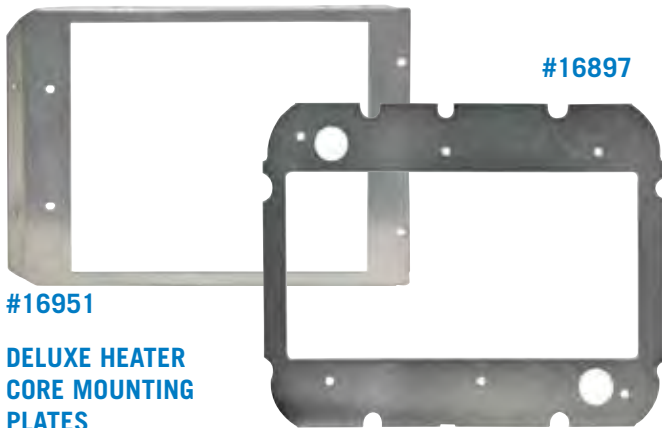

#16951

DELUXE HEATER CORE MOUNTING PLATES

The heater core mounting plate is often corroded or missing. This plate is required when installing the heater core. For deluxe heaters only.

1955-56	#16951	\$16.95/ea.
1957	#16897	\$16.95/ea.

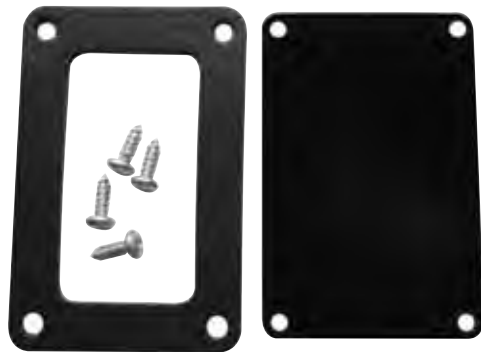

1957 DELUXE HEATER CONTROL VALVE BLOCK-OFF PLATE

1957	#17410	\$6.95/ea.
-------------------	---------------------	-------------------

DELUXE HEATER LEVER PIN AND SPRING REPAIR KIT

This kit is used on deluxe heaters only and includes the pin that the control levers pivot on as well as the spring and retainers.

1955-56	#15547	\$6.25/kit
----------------------	---------------------	-------------------



DELUXE HEATER LENS BACKING PLATES

This plate installs behind the heater lens and is sometimes missing.

1955-56	#15548	\$3.95/ea.
1957	#17411	\$4.95/ea.

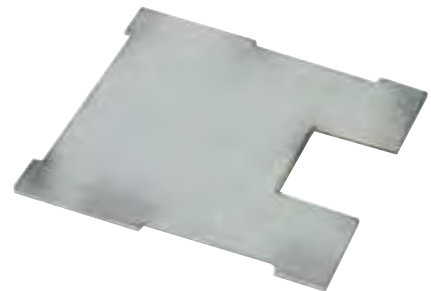



EZ SLIDER DELUXE HEATER CABLES

EZ Slider cables feature a polyethylene lining which reduces resistance and provides maximum flexibility and instant response.

1955 (Shown)	#14953.....	\$32.95/set
1956.....	#14955.....	\$32.95/set
1957.....	#14957.....	\$44.95/set

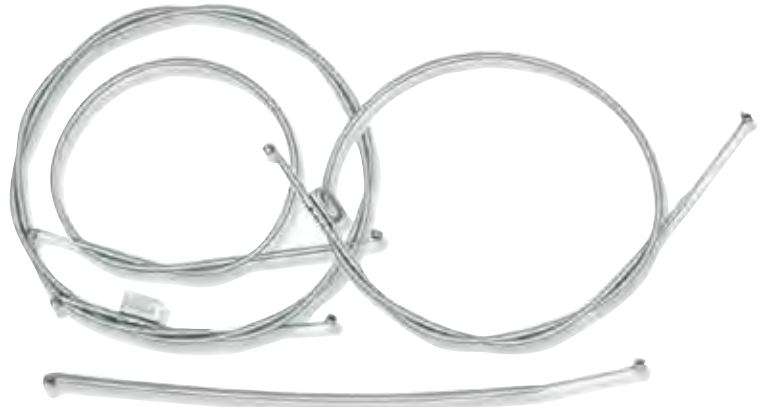

DELUXE HEATER CABLES WITH STEEL CASING

A little rust, one small kink and your original is shot! These quality steel cables will bring new life to the operation of your heater. 1957 application includes vent cable with casing.

1955.....	#462.....	\$29.95/set
1956.....	#463.....	\$29.95/set
1957 (Shown)	#464.....	\$65.95/set

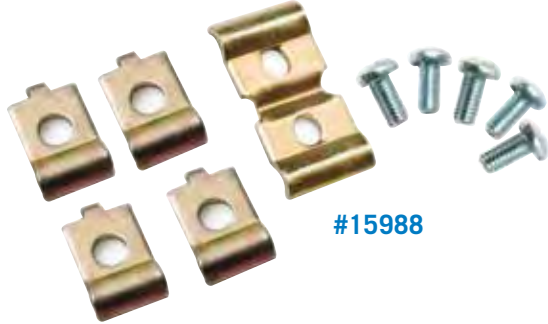

DELUXE HEATER CABLE CLIPS

For deluxe heater controls only.

1955-56 Double	#15986.....	\$6.50/ea.
----------------------	-------------	------------

Fits 55-56 deluxe heater control and 56-57 defroster lever on heater box.

1955-57 Straight Tab, Single	#15987.....	\$5.50/ea.
------------------------------------	-------------	------------

This cable clip set comes with four straight tab single cable and one double cable clip with screws.

1955-56 5-Piece.....	#15988.....	\$24.95/set
----------------------	-------------	-------------



1957 DELUXE HEATER BOX RETAINERS

1957.....	#2253.....	\$23.95/pr.
1957 Chrome	#16950.....	\$34.95/pr.

1957 DELUXE HEATER CONTROL CABLE RETAINER CLIPS

Cable retainers are often missing or broken. To order single retainer clip, order part #15594 or part #15595 for the complete 4-piece set needed to handle all cables for deluxe heater control panel.

1957.....	#15594	\$5.50/ea.
1957 4-Piece	#15595	\$19.95/set



1957 HEATER HOUSING TO INNER FENDER RETAINER

1957.....	#2254.....	\$10.95/ea.
-----------	------------	-------------

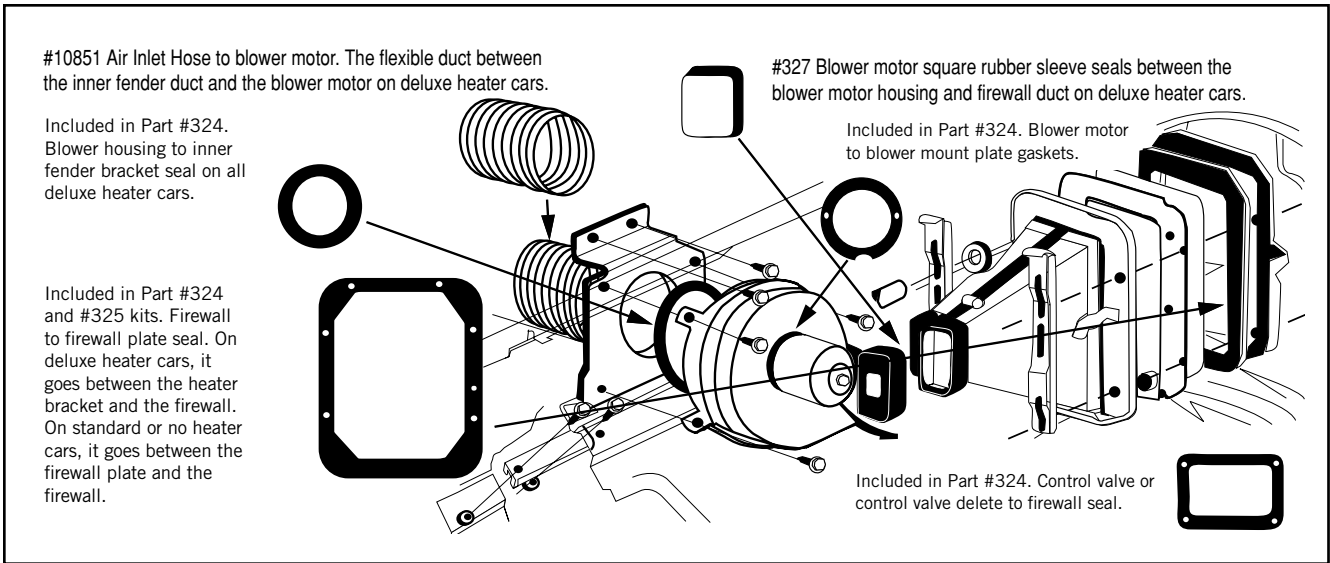

DELUXE HEATER CONTROL LEVER KNOBS

These knobs are injection-molded black plastic. 1955 and '56's include mounting hardware; 1957 knobs push on without set screws. These are must-have items when replacing the heater levers, shown below.

1955-56, '55-56 Truck	#612.....	\$11.95/set
1957 Best	#955.....	\$20.95/set
1957 Good	#16800.....	\$14.95/set



DELUXE HEATER CONTROL LEVERS

These heater control levers are a perfect reproduction of the originals, except we beefed up the shaft where the knob attaches to help prevent them from breaking.

1955.....	#465.....	\$21.95/pr.
1956.....	#466.....	\$21.95/pr.



HEATER SEALS

New gaskets are a necessity when rebuilding your heater assembly. Ours are made from top quality rubber and are designed to last for years. 1955-56 sets include the defroster seal. 1957 applications will require the purchase of #796, 1957 heater defroster seal. **Made in the USA.**

1955-56 Standard Heater	#323.....	\$20.95/kit
1955-56 Deluxe Heater.....	#322.....	\$20.95/kit
1957 Standard Heater.....	#325.....	\$17.95/kit
1957 Deluxe Heater.....	#324.....	\$17.95/kit



POLISHED ALUMINUM DELUXE HEATER CONTROL KNOB SETS

The finishing touch to your billet dash or a great custom touch all by themselves. Replace your plastic knobs with these billet sets.

1955-56 4-Piece Billet.....	#15585.....	\$102.95/set
1957 5-Piece Billet	#15584	\$112.95/set



HEATER BLOWER MOTORS

These quality replacement motors bolt in place and function just like the originals.

- 1955-63 w/ Air Conditioning, w/o Fan #2077 \$33.95/ea.
- 1955-63 w/o Air Conditioning, w/o Fan (Shown) #2078 \$39.95/ea.



DELUXE HEATER BLOWER SWITCHES

A reproduction of the original, these deluxe heater blower switches will get your heater working again like new. On part #10213 install wires with care to avoid damaging.

- 1955-56 #10213 \$39.95/ea.
- 1957 #10214 \$49.95/ea.



1957 DELUXE HEATER BLOWER MOTOR RESISTOR

This seal, located between the heater blower and the heater transition assembly, is usually in bad shape and should be replaced when rebuilding the assembly. **Made in the USA.**

- 1957 #327 \$5.95/ea.

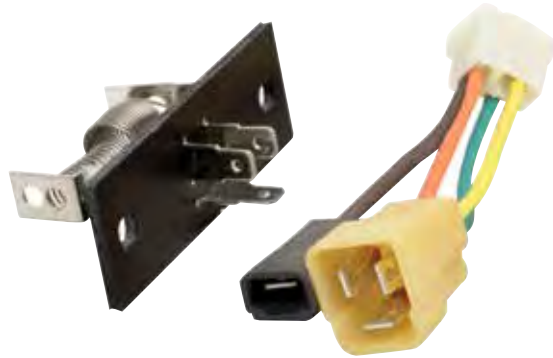

1957 DELUXE HEATER BLOWER MOTOR RESISTOR WITH ADAPTER HARNESS (WITHOUT AIR CONDITIONING)

If you are getting only one speed, or nothing at all, from your heater blower motor, this could be the problem.

- 1957 #16216 \$32.95/ea.



1957 HEATER BLOWER HOLE COVERS

- 1957 Cad Plated #11234 \$29.95/ea.
- 1957 Chrome Plated #11235 \$49.95/ea.



1957 HEATER MOTOR MOUNTING SCREWS

- 1957 #2888 \$8.95/set



Performance Stainless Steel products are **Made in the USA** of ultra-high quality 304 stainless and keep their beauty way beyond chrome or aluminum. They have an unmistakable ultra smooth finish that is highly resistant to rust, pitting and discoloration.

STAINLESS HEATER HOSE FITTINGS

1955-57 Hex,	5/8" ID x 1-3/4",	1/2" NPT	#14744	\$12.95/ea.
1955-57 Hex,	5/8" ID x 2-7/8",	1/2" NPT	#14745	\$18.95/ea.
1955-57 Hex,	3/4" ID x 1-3/4",	1/2" NPT	#14746	\$14.95/ea.
1955-57 Hex,	3/4" ID x 2-7/8",	1/2" NPT	#14747	\$19.95/ea.
1955-57 Hex,	5/8" ID x 1-3/4",	1/2" NPT	#14748	\$23.95/ea.
1955-57 12-Pt.	5/8" ID, 1-3/4",	1/2" NPT	#14750	\$15.95/ea.
1955-57 12-Pt.	5/8" ID x 2-7/8",	1/2" NPT	#14751	\$19.95/ea.
1955-57 12-Pt.	3/4" ID x 1-3/4",	1/2" NPT	#14752	\$15.95/ea.
1955-57 12-Pt.	3/4" ID x 2-7/8",	1/2" NPT	#14753	\$17.95/ea.
1955-57 45-Deg.	5/8" ID x 1-3/4",	1/2" NPT	#14756	\$34.95/ea.
1955-57 90-Deg.	5/8" ID x 2-1/8",	1/2" NPT	#14757	\$34.95/ea.
1955-57 90-Deg.	5/8" ID x 1-3/4",	1/2" NPT	#14758	\$34.95/ea.
1955-57 90-Deg.	3/4" ID x 1-3/4",	1/2" NPT	#14759	\$34.95/ea.
1955-57 90-Deg.	3/4" ID x 2-1/8",	1/2" NPT	#14760	\$34.95/ea.
1955-57 2-Piece	5/8" ID x 1-3/4",	1/2" NPT	#15301	\$38.95/pr.
1955-57 2-Piece	5/8" ID x 2-1/8",	1/2" NPT	#15302	\$38.95/pr.



STAINLESS HEATER HOSE FITTING SETS

1955-57 Hex, Contains (2) 5/8" ID x 1-3/4" & (2) 1/2" Plugs (Shown)	#14773	\$41.95/set
1955-57 Hex, Contains (1) 5/8" ID x 1-3/4", (1) 5/8" x 2-7/8" & (2) 1/2" Plugs	#14774	\$43.95/set
1955-57 12-Pt. Contains (2) 5/8" ID x 1-3/4" & (2) 1/2" Plugs (Shown)	#14775	\$41.95/set
1955-57 12-Pt. Contains (1) 5/8" x 1-3/4", (1) 5/8" x 2-7/8" & (2) 1/2" Plugs	#14776	\$49.95/set
1955-57 Hex, Contains (1) 5/8" ID, x 2-7/8" & (1) 5/8" ID x 1-3/4", 1/2" NPT	#14749	\$27.95/set
1955-57 12-Pt. Contains (2) 5/8" ID x 1-3/4", 1/2" NPT	#14754	\$28.95/set
1955-57 12-Pt. Contains (1) 5/8" ID x 1-3/4" & (1) 5/8" ID x 2-7/8", 1/2" NPT	#14755	\$31.95/set



STAINLESS SOCKET HEAD PLUGS

1955-57 1/2" NPT	#14769	\$6.95/ea.
1955-57 3/8" NPT	#14770	\$5.95/ea.
1955-57 1/4" NPT	#14771	\$4.95/ea.
1955-57 1/8" NPT	#14772	\$2.50/ea.
1955-57 3/4" NPT	#15305	\$15.95/ea.



STAINLESS 12-POINT PLUG

1955-57 1/2" NPT	#14768	\$10.95/ea.
------------------	-------	--------	-------	-------------

STAINLESS HEX PLUG

1955-57 1/2" NPT	#14767	\$9.95/ea.
------------------	-------	--------	-------	------------



ADJUSTABLE FAN THERMOSTAT

For use with electric fans. Probe mounts in stock drain plug hole on the radiator. Adjustable temp makes sure the fan runs when needed.

All..... #085..... \$43.95/ea.

ADJUSTABLE THERMOSTAT HARNESS

For use with part #085, adjustable fan thermostat.

All..... #085A..... \$49.95/ea.



FLEXI-KOOL HEATER HOSE KIT

Flexi-Cool hose kit is made of ribbed stainless steel which won't freeze or crack. Flexi-Cool hoses ribbed design improves cooling which helps prevent overheating and possible engine damage. Hoses can be formed to any angle or length while reducing installation time and maintenance costs. Kits include two 44" hoses. Makes two hoses. Dress caps and Flexi-Kool Radiator hoses are shown on page 387.

All 44", Chrome w/ Chrome Caps .. #12414..... \$64.95/kit



ORIGINAL STYLE HEATER HOSE KITS WITH RIBS

These are original style hoses with the ribs and GM markings. Kit includes original style clamps. **Made in the USA.**

- 1955-56 V8 #11237..... \$39.95/kit
- 1955-56 6-Cyl..... #11238..... \$39.95/kit
- 1957 V8..... #11239..... \$39.95/kit
- 1957 V8 w/ A/C #11240..... \$39.95/kit
- 1957 6-Cyl..... #11241..... \$39.95/kit

HEATER HOSE BRACKET

This beautiful chrome bracket suspends the heater hoses above the exhaust manifolds to protect the hoses from heat damage, and gives the engine compartment an organized appearance too. Brackets can be used individually or in pairs, depending upon the application. Some engines with air conditioning systems use only one bracket.

All..... #1963..... \$6.95/ea.



1957 HEATER HOSE BRACKET

This bracket installs under the battery box and keeps the heater hoses from the water pump and from the thermostat housing neatly routed in the engine compartment.

1957..... #1211..... \$6.75/ea.



INNER FENDER HEATER HOSE CLAMPS

These solid, heavy stainless steel clamps are polished to a high luster and include stainless steel Allen head screws.

- 1955-57 Plain..... #2511..... \$19.95/ea.
- 1955-57 Slotted #2512..... \$19.95/ea.

INTAKE MANIFOLD FITTINGS

- 1955-56 5/8" #10066..... \$17.95/ea.
- 1957 3/4" #12225..... \$16.95/ea.



INTAKE MANIFOLD HEATER HOSE FITTING

This beautiful corrosion resistant chrome fitting adds a distinctive detail to any engine. For use on small and big block intake manifolds.

All V8, 5/8" Hose, 1/2" NPT..... #1962..... \$7.50/ea.





STAINLESS THERMOSTAT SWIVEL HOUSINGS

- All 15°, Satin (Shown) #14777..... \$154.95/ea.
- All 15°, Polished (Shown) #14778..... \$179.95/ea.
- All 45°, Satin..... #14779..... \$154.95/ea.
- All 45°, Polished #14780..... \$179.95/ea.
- All Straight, Satin #15299..... \$114.95/ea.
- All Straight, Polished #15300..... \$139.95/ea.



BILLET SPECIALTIES SWIVEL THERMOSTAT HOUSINGS

- All 90°, Polished #17091..... \$92.95/ea.
- All 15°, Polished #17092..... \$92.95/ea.
- All 45°, Polished #17093..... \$92.95/ea.
- All 90°, Black..... #19374..... \$84.95/ea.
- All 15°, Black..... #19375..... \$84.95/ea.
- All 45°, Black..... #19376..... \$84.95/ea.



POLISHED, SWIVEL ALUMINUM THERMOSTAT HOUSINGS

- All 15° Swivel #12505..... \$14.95/ea.
- All 45° Swivel #12124..... \$14.95/ea.
- All 90° Swivel #12125..... \$15.95/ea.

WATER OUTLET STUD KIT

These are the two studs for the thermostat housing on V8 engines with the factory Dual 4-bbl carbs or Fuel Injection.



- 1956-61 F. I. & 2 X 4BBL #18934..... \$7.95/kit

STAINLESS WATER NECK BOLT KITS WITH BOWTIE

- All 45°, SB #14289..... \$5.95/kit
- All 90°, SB #14290..... \$4.95/kit

- ARP STAINLESS THERMOSTAT HOUSING BOLTS**
- All Hex #14003. \$12.95/set
 - All 12-pt. #14004... \$9.95/set



TEMPERATURE SENDING UNITS

Original design in fit and function.

- 1956..... #093..... \$31.95/ea.
- 1957..... #094..... \$29.95/ea.



THERMOSTATS

- All..... #081..... \$14.95/ea.
- All 160° #082..... \$8.95/ea.
- All 180° #083..... \$9.95/ea.
- All Gasket..... #084..... \$3.50/ea.

TEMPERATURE SENDING UNIT WIRE INSULATOR

The wire insulator covering is usually charred or missing. Replace this key detail item and save yourself from fried wiring.



- All..... #12121..... \$4.50/ea.

THERMOSTAT HOUSING O-RING

Replacement O-ring for all stainless thermostat housings.



- All..... #15306..... \$3.50/ea.



LOWER THERMOSTAT HOUSING GASKET

- All 235 6-Cyl..... #17886..... \$2.95/ea.

1957 Heater/Duct Seal Location

#326 Air Inlet Sleeve - Fits joint between forward and rear air duct both sides.

#548 Inner Fender Air Duct Seal - Fits the hole in the inner fender that forward air duct passes through to prevent squeaking. Installs originally with six staples each side.

Included in #324 Heater Seal Kits. Rear air duct to firewall seals, glued to the firewall on both sides.

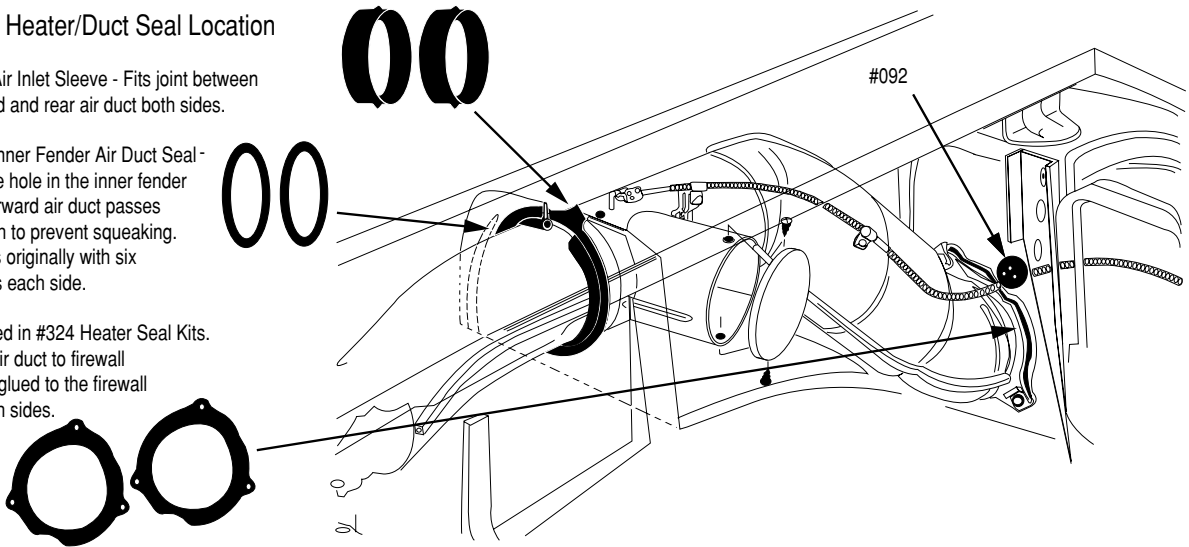

#10436



#15637



FRESH AIR VENT CONTROL CABLES

These are used to open the fresh air vents on cars that were equipped with the standard recirculating heater and include the knob. Two required per car.

1955 w/ Smooth Knob.....	#10435.....	\$66.95/pr.
1956 w/ Ribbed Knob.....	#10436.....	\$66.95/pr.
1957.....	#15637.....	\$35.95/ea.



1957 FRESH AIR VENT COVERS

These are the vent grills that mount under the dash on the firewall. Sold in pairs.



1957.....	#17778.....	\$59.95/pr.
-----------	-------------	-------------

FRESH AIR VENT ASSEMBLY WITH CABLE

These fresh air vent assemblies come as a pair complete with cables. They will work for both 1955 and 56 but the knobs are only correct for 1956. The 1956 cable used a ribbed knob, the 1955 used a smooth knob. (Use Danchuk #14035 vent cables for a correct 1955 installation.)

1955-56	#16036.....	\$124.95/set
---------------	-------------	--------------



1957 FRESH AIR DUCT CABLE RETAINERS

Use these spring steel clips to correctly connect the fresh air cables to your vent assembly.

1957.....	#1204.....	\$3.95/set
-----------	------------	------------



1957 FORWARD IN FENDER FRESH AIR DUCT

This is a reproduction of the original fresh air duct that mounts inside the front fenders of 1957's. Fits driver or passenger sides. Two required per car.

1957..... #16875..... \$189.95/ea.



1957 AIR DUCT DRAIN TUBE

This tube bolts into the underside of the air ducts and runs forward through the drain tube grommets mounted in the front splash pan. They drain water out of the fresh air ducts.

1957..... #12605..... \$18.95/ea.

1957 AIR INLET HOSE

Fits between heater blower and outside air duct.

1957 Original, 4-1/2"..... #10851..... \$17.95/ea.



1957 AIR INLET DRAIN TUBE GROMMETS

These mount in the front splash pan on either side and the air inlet drain tubes go through them. These keep the air inlet drain tubes from rattling.

1957..... #334..... \$4.95/pr.



VENT CABLE TO DASH SCREW AND WASHER KIT

Original clutch head design.

1955-56 #2895..... \$3.95/kit

CLUTCH HEAD SCREWDRIVERS

This 4-piece set should cover all your needs when restoring your classic Chevy.

All 4-Piece Set #16367..... \$21.95/set



KICK PANEL VENT DOOR SEALS

1955-56 #10455..... \$12.95/set

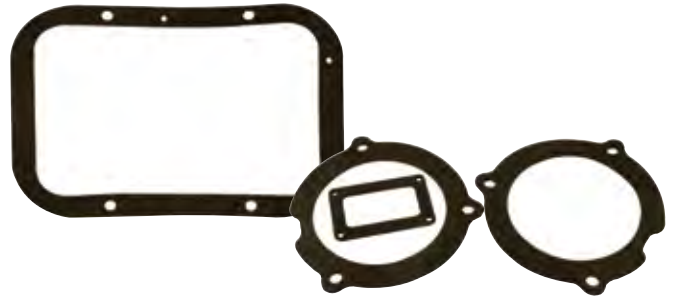

1957 FRESH AIR VENT SEAL KIT

1957 Factory Dash w/ Vintage Air #17659..... \$7.95/kit

1957 AIR DUCT-TO-INNER FENDER SEALS

1957..... #548..... \$9.95/pr.



1957 HEATER DEFROSTER SEAL

This seal is located between the heater distributor assembly and the dashboard vent assembly. Without it the defrost function on the heater will not operate.

1957..... #796..... \$10.95/ea.



1957 FRESH AIR INLET SLEEVES

These sleeves seal the connection between the front duct assembly and the rear duct and valve assembly. **Made in the USA.**

1957..... #326..... \$10.95/pr.





RADIATOR IN V8 POSITION

Mounts behind the core support between the core support and the engine inside the engine compartment.

RADIATOR IN 6-CYL. POSITION

Mounts in front of the core support between the core support and the grille.

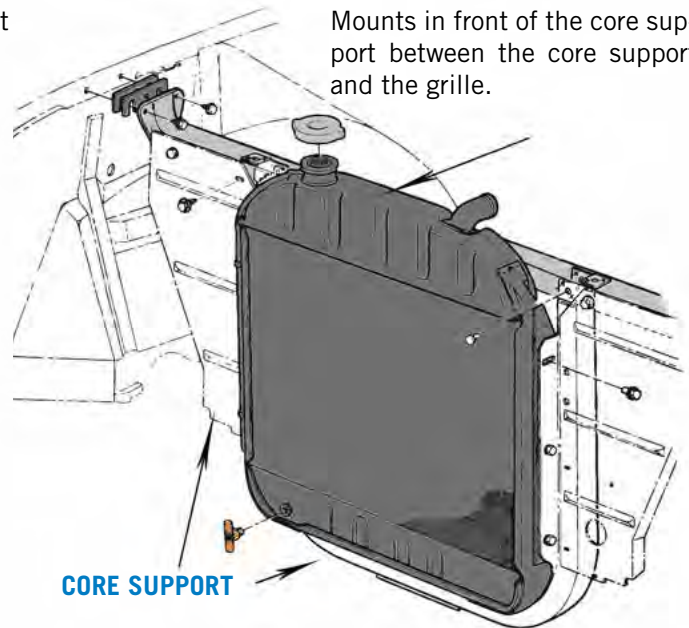
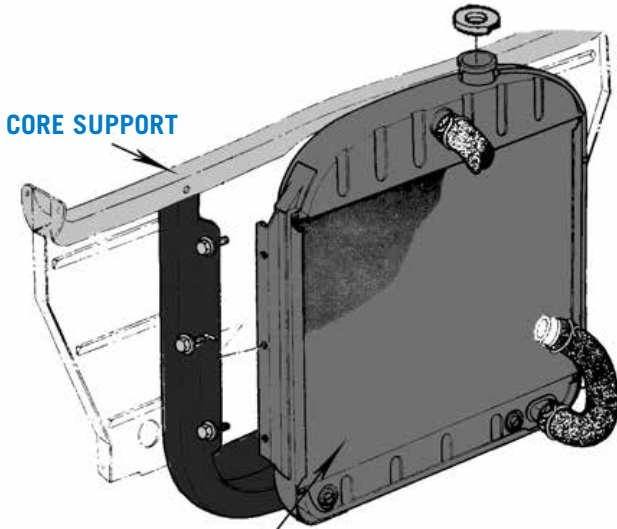

RADIATOR IN V8 POSITION

CHROME STEEL OR BLACK POWDER COATED STEEL FAN SHROUDS

The best of the best! We pulled out all the stops and made these the way Chevy would have. These beautiful shrouds are made from top quality thick steel, powder coated black or chrome finished and are custom fit for your application. With an 18¾-inches opening you'll have no trouble with fan clearance. **Made in the USA.** US Patent D675,724S.

- 1955-57 V8 in 6-Cyl. Core Support, Black Shroud..... #16625..... \$129.95/ea.
- 1955-57 V8 in 6-Cyl. Core Support, Chrome Shroud, Black Brackets..... #16625C..... \$249.95/ea.
- 1955-57 Chrome Brackets for #16625C #16625B..... \$69.95/pr.

- 1955-57 V8 in Stock Position, Black Shroud #16626A..... \$129.95/ea.
- 1955-57 V8 in Stock Position, Chrome Shroud, Black Brackets #16626C..... \$249.95/ea.
- 1955-57 Chrome Brackets for #16626C #16626B..... \$69.95/pr.

- 1955-57 V8 in 6-Cyl. Position, when using #11236 6-Cyl. Position Conversion Brackets, Black Shroud #16627A..... \$139.95/ea.
- 1955-57 V8 in 6-Cyl. Position, when using #11236 6-Cyl. Position Conversion Brackets, Chrome Shroud, Black Brackets #16627C..... \$259.95/ea.



Flex-a-lite
BLACK MAGIC S-BLADE FAN

Flex-a-lite Black Magic Fans use a lightweight one-piece nylon shroud with full-contact rubber seal mounts as a puller behind radiator. Flex-a-lite Black Magic fans have a rigid bracket system which means no through-core mounting. Great cooling for higher horsepower applications. Includes adjustable thermostat with air conditioning relay, reversible. Measures 16-inches x 18-inches x 4¹/₄-inches. **All 3000CFM #18026..... \$319.95/ea.**



Flex-a-lite
BLACK MAGIC EXTREME ELECTRIC FAN KIT

The Flex-A-Lite Black Magic Xtreme fan out performs typical cage fans by 45%-50%, and provides consistent cooling regardless of engine speed. Get more power and better mileage by replacing your stock fan. Includes adjustable thermostat, air conditioning relay and manual switch. Available in puller version only. Recommended for 6-cylinder position radiators. Measures 21¹/₂-inches x 17¹/₂-inches x 4³/₁₆-inches. Please check and verify clearance before placing order.

All w/ Relay & Thermostat, 3300 CFM
..... #13452..... \$341.95/kit



FAN MOUNTING BRACKETS

These brackets give you the extra mounting surface sometimes needed when your radiator is in the 6-cylinder position and you are installing a universal electric fan with a built in shroud like #13452 or #18026 shown at left.

Made in the USA.
1955-57 #11236A..... \$74.95/pr.



Photo courtesy of GERTMAN2000



ELECTRIC, VARIABLE SPEED FAN CONTROL

Sets fan speed from 60%-100% depending on thermostat setting. Reduces charging spikes and current load. Runs your cooling fans 30 seconds after your car is turned off to reduce heat soak.

All..... #13459..... \$179.95/ea.



PAINLESS FAN-THOM II ELECTRIC FAN CONTROL KITS

Fan-Thom fan controls offer you clean, simple and safe fan controller for your electric fans. The supplied thermostat threads into the engine or cooling system for a professional installation.

All 200° #14615..... \$58.95/kit

Note: Turns fan on at 200° & off at 185°.

All 185° #14616..... \$53.95/kit

Note: Turns fan on at 185° & off at 170°.



Flex-a-lite

17-INCH FLEX FAN

Please check and verify clearance before placing order.

1955-57 #12164..... \$79.95/ea.

DAKOTA DIGITAL PROGRAMMABLE FAN CONTROLLER WITH LED READ-OUT



This fan controller

is programmable and will work with either single or dual fan applications. Set what temp the fan(s) turn on/off as well as having the fans stay on for up to five minutes after the engine is shut down. Digital temp readout makes set up a breeze and it will work with your existing temp gauge and sending unit. Intended to be mounted in cabin. Do not mount in engine compartment.

All #15123..... \$139.95/ea.



Flex-a-lite

ELECTRIC FAN SWITCH

Use this switch as a manual override, regardless of thermostat setting, to turn on or off your cooling fan.

All Illuminated #13460..... \$24.95/ea.

ELECTRIC FAN RELAY KIT

This fan relay kit can be used either manually or in conjunction with a temperature sending switch. Designed for use with a fused power source. Full instructions for both the switched and manual operation are included.



All..... #12344..... \$25.95/kit



Flex-a-lite

AIR CONDITIONING RELAY KIT FOR ELECTRIC FANS

This relay automatically engages the fan when the air conditioning is turned on.

All..... #13458..... \$23.95/ea.



Flex-a-lite FAN SPACERS

1955-57 1/2" #12165..... \$18.95/ea.

1955-57 1" #12166..... \$18.95/ea.

1955-57 2" #12167..... \$21.95/ea.



VINTAGE AIR DUAL FAN PACKAGES

Vintage Air designed these specifically to help cool Tri-Five's with cooling problems, and they got it right! These dual electric fan packages are just the thing for those hot summer days cruising at 2 MPH as you don't need any forced airflow, the fans do all the work! The #17011 features two 11-inch 5-blade fans which pull a whopping 2750 CFM of air. Motor thickness is 4.250 and the fan thickness is 2.60 which means it will fit almost anywhere.

- 1955-57 6-Cyl. Position w/ Controls** #17010..... **\$422.95/ea.**
- 1955-57 6-Cyl. Position w/o Controls** #17011..... **\$299.95/ea.**

Flex-a-lite®

S-BLADE ELECTRIC FANS

These S-Blade fans can be used as a primary or auxillary fan. The 16" Syclone pulls 2500CFM which makes it strong enough to replace your belt driven fan, freeing up horsepower and increasing mileage. Both fans are reversible (push/pull). Please check and verify clearance before placing order.



- All 14", w/o Relay & Thermostat, 1530 CFM** #13457 **\$119.95/ea.**
- All 16", Syclone, 2500 CFM w/o Relay & Thermostat** #12168 **\$169.95/ea.**

ELECTRIC FAN TEMPERATURE SWITCH

This fan switch is just the thing for controlling those high dollar electric fans you installed. Or maybe you just need a replacement for a unit gone south. This switch installs in the cylinder head or the intake manifold and triggers an electric relay. Turns on at 195° and off at 180° and is 3/8" NPT electric fan switch. **Made in the USA.**



- All 3", ON 195/OFF 180**..... #19005..... **\$26.95/ea.**

DERALE PWM FAN CONTROLLER

Derale Performance is changing the rules of engine temperature control with the smart technology of their patented PWM Fan Controller. The controller monitors your engine temperature via the cool side of the radiator, therefore providing a more accurate reading for your cooling system. Using Soft Start Technology, fans ramp up slowly which eliminates harmful AMP spikes. The unit will continuously monitor your engine's temperature and operate the fans at the optimum fan rate as needed between 1 to 100%. The net result; the electric fans often only run between 40-60% to keep your engine cool. Additional benefits include, reduced fan speeds which means reduced fan noise, which tends to compete with that sweet sound of your engine!



- All Variable Speed** #18483 **\$219.95/ea.**



COLD-CASE RADIATORS O/S

COLD-CASE radiators are original appearing and have the correct stampings. They are 100% TIG welded aluminum and feature polished OE style upper and lower tanks and dual 1-1/4" tubes in a core that has 16 fins per inch for superior cooling. The corrugated fins give more surface area and more thermal transfer. Fully pressure tested, these radiators will work for both manual and automatic transmission applications. Danchuk # 18914 is a 1955-1957 direct fit radiator that mounts in the V8 position, # 18915 is a 1955-1956 direct fit radiator that mounts in the 6-cylinder position and # 18916 is a 1957 direct fit radiator that mounts in the 6-cylinder position.

- 1955-1957 V8** #18914..... **\$399.95/ea.**
- 1955-1956 6-Cylinder** #18915..... **\$399.95/ea.**
- 1957 6-Cylinder** #18916..... **\$399.95/ea.**



COLD-CASE RADIATORS WITH FAN AND SHROUD O/S

COLD-CASE radiators are original looking and have the correct stampings. They are 100% TIG welded aluminum and feature polished OE style tanks and dual 1-1/4" tubes in a core that has 16 fins per inch for superior cooling. The corrugated fins give more surface area and more thermal transfer. Fully pressure tested, these radiators will work for both manual and automatic transmission applications. These kits includes an aluminum fan shroud and a 16" electric fan rated at 2500 CFM. The parts #18917 and #18918 are direct fit radiators that mount in the 6-cylinder position. The #18919 is a V8 radiator with a fan shroud kit that mounts in the 6-cylinder position using part #11236 adapter brackets. Although the #18919 radiator is a direct fit unit, there is not enough room to mount this on the V8 side of the core support with the shroud and fan, so it must be mounted in the 6-cylinder position with required part #11236 brackets. All 3 part numbers require part #18920 or similar electric fan wiring kit.

- 1955-56 w/ Fan and Shroud, 6-Cylinder Mounting Position**..... #18917..... **\$549.95/ea.**
- 1957 w/ Fan and Shroud, 6-Cylinder Mounting Position** #18918..... **\$549.95/ea.**
- 1955-57 w/ Fan and Shroud, V8 Position**..... #18919..... **\$549.95/ea.**



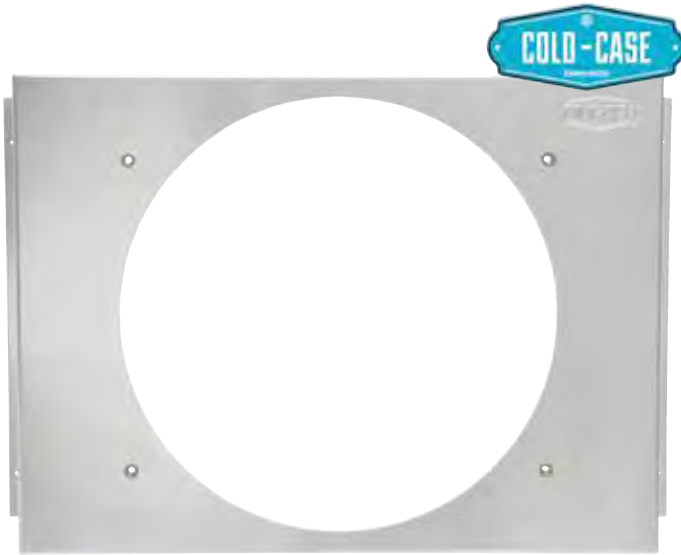

COLD CASE FAN SHROUDS

For the customer who has already installed a Cold-Case radiator and now wants to add one of their shrouds and fan kits, we now carry both the shroud and fan separately. For part # 19879, installation will require moving the radiator to the 6-cylinder position with part #11236 conversion brackets. There is not enough room between the water pump and the radiator for installation of this shroud and an electric fan. Use part #18978 electric fan. **Note:** If your radiator is mounted on the engine side of the core support, you have a V8 core support. If it is mounted on the grille side of the core support, then it's a 6-cylinder support, please check before ordering. If you are in doubt as to what you need please call our Customer Service Department at 800-854-6911 for assistance.

1955-57 V8 Pos. Radiators #18976 \$79.95/ea.
1955-57 6-Cyl. Pos. Radiators #18977 \$79.95/ea.

COLD CASE 16" ELECTRIC FAN

1955-57 2500 CFM #18978 \$79.95/ea.



COLD-CASE ELECTRIC FAN WIRING KIT

Designed to easily install the Cold-Case radiators with fan and shroud. Includes wiring, thermostat and relay. Turns fans on at 190 degrees.

All..... #18920..... \$89.95/ea.

COLD-CASE RADIATOR CAP

This billet Cold-Case radiator cap is just the thing to cap off your Cold-Case radiator installation. Push on style fits Cold-Case radiators ONLY. Not suitable for use in vehicles using a stock heater core.



All 16 lb..... #18921 \$24.95/ea.



Photo courtesy of GERTMAN2000



BE COOL RADIATORS

An OEM radiator just isn't designed to cool a high-horsepower engine, and overheating can take the fun out of driving your classic very quickly. Now, Be Cool has your answer. A high-quality Be Cool radiator will not only lower your temp, but their technology produces radiators that are 40% lighter than copper brass OEM units. Their epoxy free construction provides better heat dissipation while allowing complete repairability. Available in standard finish or polished. Installation note: 1957 6-Cylinder installs will need to modify the hood baffle for clearance of the inlet, all Be Cool radiators use dual 1-inch cores.

RADIATORS



BE COOL ALUMINUM DOWNFLOW RADIATORS O/S

When mounting in the 6-cylinder position on 1957's, the hood baffle may require modifications.

- 1955-57 Standard, V8 & 6-Cyl. Position #13762..... \$599.95/ea.
- 1955-57 Auto, V8 & 6-Cyl. Position #13763..... \$699.95/ea.
- 1955-57 Standard, V8 & 6-Cyl. Position, Polished #13772..... \$749.95/ea.
- 1955-57 Auto, V8 & 6-Cyl. Position, Polished #13773..... \$829.95/ea.

BE COOL ALUMINUM CROSSFLOW RADIATORS O/S

- 1955-57 Standard #13764..... \$599.95/ea.
- 1955-57 Auto #13765..... \$699.95/ea.
- 1955-57 Standard, Polished #13774..... \$749.95/ea.
- 1955-57 Auto, Polished #13775..... \$829.95/ea.
- 1955-57 Standard, LS #17526..... \$699.95/ea.
- 1955-57 Auto, LS #17527..... \$799.95/ea.
- 1955-57 Standard, Polished, LS... #17528..... \$799.95/ea.
- 1955-57 Auto, Polished, LS #17529..... \$849.95/ea.

BE COOL OE V8 POSITION RADIATORS O/S

What's that you say? You want a vintage radiator design produced with today's technology? By customer demand Be Cool has expanded their industry proven product line with their Be Cool OE series radiators. Be Cool OE series radiators combine a modern aluminum core design with the factory fit, finish and correct-appearing ribbed factory tank design of a stock OE radiator. Your HIGHER than factory-rated horsepower classic Chevy won't overheat with a Be Cool OE series radiator!

- 1955-57 Black, Aluminum, Standard, V8 Position #16916..... \$649.95/ea.
- 1955-57 Black, Aluminum, Auto, V8 Position #16917..... \$699.95/ea.





ALUMINUM CROSSFLOW RADIATOR CONVERSION MODULES O/S

Be Cool's Super Street Series Power Cooling Module assemblies are designed to cool vehicles with up to 700 dyno-rated horsepower. Each kit contains a Be Cool aluminum dual 1-inch core crossflow performance radiator with oval fluted tubes, a dual 11-inch electric puller fan set with vented shroud for highway cruising, a set of fan mounting brackets with hardware, a diamond cut, vented coolant recovery tank, a primary fan wiring harness with a 40 amp relay, a secondary wiring harness to independently control the second fan and to top it all off a Be Cool billet radiator cap. Available in standard finish or polished. Picture is representation only. 1955-57 radiator is slightly different.

1955-57 Standard	#13758.....	\$1199.95/ea.
1955-57 Auto.....	#13759.....	\$1299.95/ea.
1955-57 Standard, Polished	#13768.....	\$1499.95/ea.
1955-57 Auto, Polished.....	#13769.....	\$1599.95/ea.



Hope to see you at the Danchuk Tri-Five Nationals!

PHOTO COURTESY OF GERTMAN2000



CROSSFLOW POLISHED RADIATOR CONVERSION MODULES O/S

Be Cool now offers you the ultimate in crossflow conversion modules. Each system comes fully polished and completely assembled with an aluminum core support, radiator, recovery and reservoir tanks and chrome plated fan shroud with aluminum motor covers. Kits are available with or without air conditioning condenser and with or without integral transmission coolers. Special order item. Drop shipped by vendor. Everything you need to keep your hot rod cool. Be sure to order enough BeCoolant, part #15562 on page 681, to properly protect your investment.

1955 Auto w/ A/C.....	#15521.....	\$3899.95/ea.
1956 Auto w/ A/C.....	#15522.....	\$3899.95/ea.
1957 Auto w/ A/C.....	#15523.....	\$3899.95/ea.
1955 Auto w/o A/C.....	#15524.....	\$3899.95/ea.
1956 Auto w/o A/C.....	#15525.....	\$3899.95/ea.
1957 Auto w/o A/C.....	#15526.....	\$3899.95/ea.
1955 Standard w/ A/C.....	#15527.....	\$3699.95/ea.
1956 Standard w/ A/C.....	#15528.....	\$3699.95/ea.
1957 Standard w/ A/C.....	#15529.....	\$3699.95/ea.
1955 Standard w/o A/C.....	#15530.....	\$3699.95/ea.
1956 Standard w/o A/C.....	#15531.....	\$3699.95/ea.
1957 Standard w/o A/C.....	#15532.....	\$3699.95/ea.

DESERT COOLER RADIATORS O/S

They drop right into your favorite Tri-Five and feature the latest cooling technology. V8 owners can choose from either standard or high-efficiency styles. High-efficiency models are recommended for air conditioning and performance applications. Each unit includes side shims, transmission line fitting, petcock and drain hose making for an easy installation. If the radiator is mounted on the engine side of the core support, you have a V8 core support. If it's on the grille side, then it's a 6-cylinder support. Radiators fit both standard and automatic transmission equipped cars. Don't forget to order a fan shroud, parts #16625-16627C on page 372 for the best in cooling performance. **Made in the USA.**

1955-57 V8 Position, 4-Row	#399	\$482.95/ea.
1955-56 High-Efficiency, 3-Row, 6-Cyl. Position	#336	\$472.95/ea.
1955-57 High-Efficiency, 4-Row, V8 Position....	#337	\$489.95/ea.
1955-56 High-Efficiency, 4-Row, V8 in 6-Cyl. Position	#12072	\$466.95/ea.
1957 Hi-Efficiency, 4 Row, V8 in 6-Cyl. Position.	#12072A	\$466.95/ea.





U.S. Radiator



U.S. RADIATOR ALUMINUM CROSSFLOW RADIATORS 

Crossflow conversion radiators from US Radiators feature dual 1-inch tubes and have a fully welded construction and come in standard finish or fully polished. Radiators are available in either standard or auto versions and can be ordered with or without fans. Fan controller sold separately.

1955-57 w/ Fans, Auto.....	#17861.....	\$749.95/ea.
1955-57 w/ Fans, Standard.....	#17862.....	\$749.95/ea.
1955-57 w/ Fans, Polished, Auto.....	#17863.....	\$847.95/ea.
1955-57 w/ Fans, Polished, Standard.....	#17864.....	\$847.95/ea.
1955-57 w/o Fans, Auto.....	#17865.....	\$423.95/ea.
1955-57 w/o Fans, Standard.....	#17866.....	\$423.95/ea.
1955-57 w/o Fans, Polished, Auto.....	#17867.....	\$572.95/ea.
1955-57 w/o Fans, Polished, Standard.....	#17868.....	\$572.95/ea.



U.S. RADIATOR DOWNFLOW ALUMINUM RADIATORS 

Aluminum Downflow radiators feature fully welded construction (no epoxy) and dual 1" tubes. Radiators are available in either a standard or Tripleflow configuration. Tripleflow radiators achieve the maximum temperature drop by creating walls which force the coolant to pass through the core three times resulting in greater temperature reductions. Aluminum radiators do not have transmission coolers. An auxiliary cooler will be required so be sure to check out our transmission coolers starting on page 517. When mounting #13274 the hood baffle may require modification on '55-'56 application. All triple flow radiator upper inlets are on driver side of top tank. Don't forget to order a fan shroud, parts #16625-16627C on page 372 for the best in cooling performance.

Made in the USA.

1955-57 V8.....	#13262.....	\$498.95/ea.
1955-57 V8, Triple Flow.....	#13266.....	\$582.95/ea.
1955-56 V8 in 6-Cylinder Position.....	#13270.....	\$498.95/ea.
1955-56 V8 in 6-Cylinder Position, Triple Flow.....	#13274.....	\$582.95/ea.



CHAMPION ALUMINUM RADIATORS O/S

We are proud to offer you Champion Radiators, the latest and greatest in aluminum radiators. All of the radiators that we carry are 100% aluminum from the tank, core, and welds with no epoxy, and come with three rows of 3/4-inch tubes. All Champion radiators are equipped with a transmission cooler.

- 55-56 6-Cyl. Position Std-Auto** #17707 \$299.95/ea.
- 55-56 6-Cyl. Position Std-Auto, Polished** #17708 \$419.95/ea.
- 1955-57 V8 Position Std-Auto** #17709 \$299.95/ea.
- 1955-57 V8 Position Std-Auto, Polished** #17710 \$419.95/ea.

AMERICAN EAGLE ALUMINUM RADIATORS O/S

American Eagle Radiators are made with the same high level of quality that the Champion cooling system radiators. They feature the same billet fill necks and no epoxy. All American Eagle radiators feature 2.25" thick core with two 1-inch tubes and a transmission cooler.

- 1955-57 V8 Position Std-Auto** #17713 \$249.95/ea.
- 1955-57 V8 Position Std-Auto, Polished** #17714 \$319.95/ea.



GRIFFIN ALUMINUM RADIATORS O/S

These HP series radiators feature a high efficiency core with two 1.25" tubes, and a core thickness of 2.75". Aluminum radiators include side shims, transmission line fittings, petcock and drain hose. Radiators fit standard and automatic equipped cars and are compatible with Danchuk fan shrouds, parts #16625-16627C on page 372.

- 1955-57 V8** #733 \$719.95/ea.
- 1955-56 6-Cyl** #734 \$719.95/ea.
- 1957 6-Cyl** #735 \$699.95/ea.



HOT RODS BY DEAN COOLING MODULES O/S

These cooling system modules by Hot Rods by Dean are a complete cooling solution for your Shoebox Chevy. The clean and simple all steel core support is black powder coated and installs in the factory location. This design moves the radiator and fans forward providing the maximum amount of engine compartment space to clear any engine with any serpentine pulley system. The high efficiency single-pass cross-flow radiator has a heavy duty 2.5-inch aluminum core running two 1" tubes. The system comes with a custom mounted overflow tank, 16 lb. polished aluminum radiator cap, dual Maradyne 14-inch high performance electric cooling fans (2135 CFM each), fan relay harness with 185 degree thermostat, dual fan relay, aluminum fan mounting bracket and stainless fasteners. They even include the custom hood latch assembly and hood support with brackets that you need for 1955 applications because these units move the the radiator forward for extra room in the engine compartment. Comes completely assembled with installation instructions. Shown in powdercoated red but delivers in powdercoated black only. Special order item. **Made in the USA.**

1955 Standard, Satin	#17925	\$2995.95/ea.
1955 Standard, Polished	#17926	\$3395.95/ea.
1955 Standard, w/ AC, Polished	#17927	\$3949.95/ea.
1955 Standard, w/ AC & PS, Polished	#17928	\$4095.95/ea.
1956 Standard, Satin	#17929	\$2949.95/ea.
1956 Standard, Polished	#17930	\$3295.95/ea.
1956 Standard, w/ AC, Polished	#17931	\$3895.95/ea.
1956 Standard, w/ AC & PS, Polished	#17932	\$4049.95/ea.
1957 Standard, Satin	#17933	\$2895.95/ea.
1957 Standard, Polished	#17934	\$3245.95/ea.
1957 Standard, w/ AC, Polished	#17935	\$3845.95/ea.
1957 Standard, w/ AC & PS, Polished	#17936	\$3995.95/ea.

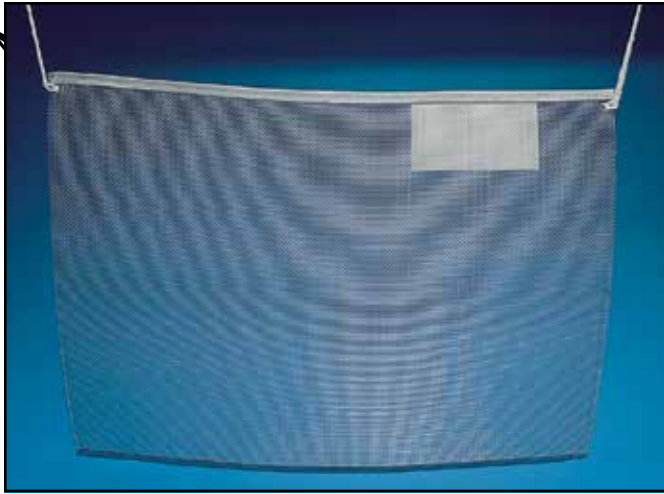

RADIATOR BUG SCREEN

If you show your daily driver or drive a show car daily, these bug screens are a must. Easy to install and remove.
 1955-57 #2871 \$24.95/ea.



RADIATOR SUPPORT TO FENDER SHIM KITS

These install between the ends of the core support upper bar and the inner fenders. They are used to fine tune the alignment of the front fenders. Hardware included.
 1955-56 #1168 \$10.95/ea.
 1957 (Shown) #1169 \$12.95/ea.

1957 RADIATOR CORE SUPPORT WIRING GROMMET

This grommet installs in the radiator filler panel. The connector for the grille bar harness to the main underhood harness fits here.
 1957 #357 \$5.95/ea.



RADIATOR CONVERSION BRACKETS

Allows you to mount a V8 position radiator into the 6-cylinder position of a V8 core support. **Made in the USA.**
 1955-57 #11236 \$54.95/pr.



RADIATOR SUPPORT TO FRAME SHIMS

This kit is used with the core support rubber cushions #604 to attach lower section of the radiator core support to the frame bracket.
 1955-57 #1167 \$13.95/ea.



RADIATOR CORE SUPPORT RUBBER CUSHIONS

These cushions are used with the radiator support to frame shims, #1167, shown above, to attach lower section of the radiator core support to the frame bracket. **Made in the USA.**
 1955-57 #604 \$13.95/pr.

RADIATOR SUPPORT WIRE HARNESS CLIP

This clip installs on the radiator cross bar and supports the wiring harness. 3-6 clips needed per car.
 1955-57 #12333 \$0.95/ea.



SEE PAGES 541-544 FOR RADIATOR CORE SUPPORTS, FILLER PANELS, SUPPORT BARS, AND STRAP ASSEMBLIES.



CHROME RADIATOR COVERS 

The first thing they see when lifting the hood is the radiator. Nothing can dress it up better than our chrome radiator covers. Make your engine compartment shine! **Technical Note:** As to not detract from the show quality, our radiator covers are sealed. To access radiator cap, cover needs to be removed. Note: These are for hood up show display only. Must be removed before closing hood or driving. **Made in the USA.**

1955-57 w/ Shroud, Pyramid Peak	#2709.....	\$249.95/ea.
1955-57 w/ Shroud, Louvered	#2710.....	\$249.95/ea.
1955-57 w/ Shroud, Ribbed	#2711.....	\$249.95/ea.
1955-57 Lower, Louvered	#2712.....	\$108.95/ea.
1955-57 Lower, Ribbed.....	#2713.....	\$108.95/ea.



EVANS WATERLESS HIGH PERFORMANCE COOLANT SYSTEM 

Evans High Performance Waterless Coolant is specifically designed for all modern, classic, and vintage engines. Evans HPC has a boiling point of 375° F while protecting down to -40° and will not vaporize; eliminating boilover and after-boil preventing coolant loss and reducing strain on cooling systems. Since Evans contains no water it effectively eliminates corrosion and minimizes the potential for electrolysis and reduces maintenance costs. When converting an engine from water-based coolant to HPC, great care should be given during the conversion process to ensure that all the old water-based coolant is removed. It is recommended that the system be flushed with Evans Pre-Fluid (part #18460) before installing Evans HPC. When the conversion process is complete, the water content should be no more than 3%. **Made in the USA.**

EVANS WATERLESS HIGH PERFORMANCE COOLANT

All 1-Gallon..... #18459..... \$46.95/ea.

EVANS WATERLESS COOLANT PREP FLUID

All 1-Gallon..... #18460..... \$32.95/ea.

EVANS COOLANT ANALOG REFRACTOMETER

All..... #18595..... \$29.95/ea.



BILLET SPECIALTIES SMOOTH OVERFLOW TANKS

The Billet Specialties overflow tanks are the best on the market. Precision machined from 6061 T-6 billet aluminum and polished to the famous Billet Specialties standards they feature two adjustable polished billet mounting straps for precise alignment.

Product Features:

- Knurled O-ring cap for a no-leak seal
- Stainless hardware included
- Aluminum push-on fittings included
- Industry leading mirror finish polish
- Internal return tube

All 8.75"	#17096.....	\$149.95/ea.
All 8.75", Black	#19307.....	\$142.95/ea.
All 13"	#17094.....	\$124.95/ea.
All 15"	#17095.....	\$124.95/ea.



POLISHED STAINLESS STEEL COOLANT OVERFLOW TANK

This polished stainless steel overflow tank was designed to be kept out of view but it's so beautiful you'll want to show it off. One quart capacity tank with a precision knurled cap and a highly polished finish. Approximately 18-3/4" long, mounting hardware included.

All..... #1274 \$39.95/ea.



RADIATOR HOSE CLAMP

1955-57 #12163..... \$1.95/ea.



RADIATOR AND HEATER HOSE CLAMPS

A spring style clamp was original equipment on all 1955-1957 Chevy models. **Made in the USA.**

1955-56	#398.....	\$9.95/set
1957.....	#398A.....	\$23.95/set

#15055



#15056

HOSE ADAPTERS

In-Line hose adapters provide a threaded fitting for temp senders or fan switches. Features two 1/4-inch threaded ports for sending units.

All 1-1/2", Upper	#15055.....	\$49.95/ea.
All 1-3/4", Lower	#15056.....	\$54.95/ea.



RADIATOR ZINC ANODE

Installs in place of petcock and protects the cooling system from corrosion.

All 1/4" NPT #14845..... \$11.95/ea.



STEP UP/DOWN RADIATOR HOSES

With all the different engine and radiator combinations that are being put in classic Chevy's these days sometimes the inlets and outlets don't always match up to the current offering of radiator hoses. These tapered radiator hoses are made of silicone for years of service and are great when a custom application requires custom hoses. Great when using tubing/hose combinations on late model engine and radiator installs.

- All 1-1/4" to 1-3/4" #17773..... \$21.95/ea.
- All 1-1/4" to 1-1/2" #17772..... \$21.95/ea.

FLEXI-KOOL RADIATOR HOSE KITS

Flexi-Kool Hose kits are made of ribbed stainless steel which won't freeze or crack. Flexi-Kool hoses ribbed design improves cooling which helps prevent overheating and possible engine damage. Hoses can be formed to any angle or length while reducing installation time and maintenance costs. No longer do you have to search to find a hose that you can make work. Just order a Flexi-Kool hose kit for downflow or crossflow radiator conversions and you know you'll have the right hose all the time. 48" hose kits make two hoses. Matching Flexi-Kool heater hoses are shown on page 368.

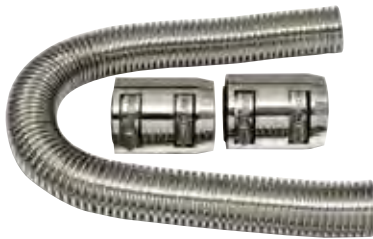

- All 24", Chrome, w/ Chrome Caps . #12413..... \$49.95/kit
- All 48", Chrome w/ Chrome Caps .. #12504..... \$69.95/kit

SILICONE HOSE RADIATOR PLUMBING KIT

This reinforced silicone radiator plumbing kit includes two 90° elbows, one 45° elbow and one 6-inch straight connector along with one 6-inch aluminum connector and one 45° aluminum connector.



- All..... #17013..... \$89.95/kit

#044A

#047A

#045A

#046B

SHOW QUALITY RADIATOR HOSES

These radiator hoses are correctly numbered with the GM codes used in 1955, 1956 and 1957. These are the hoses for detail-oriented collectors and anyone seeking to restore the original factory look to their engine compartment. Original style spring clamps are included.

- 1955-57 V8, Upper Hose #044A..... \$22.95/ea.
- 1955-57 V8, Lower Hose #045A..... \$22.95/ea.
- 1955-56 6-Cyl., Upper Hose #046B..... \$21.95/ea.
- 1957 6-Cyl., Upper Hose..... #046A..... \$26.95/ea.
- 1955-57 6-Cyl., Lower Hose #047A..... \$28.95/ea.
- 1956-57 Dual 4BC & F.I., Upper Hose(Not Shown) #2559..... \$43.95/ea.



RADIATOR HOSES

Made with the same quality materials as our show quality hoses, but priced for the budget-oriented daily driver. For the 1957 6-Cylinder upper hose, see show quality hoses, above.

- 1955-57 V8, Upper Hose #044..... \$17.95/ea.
- 1955-57 V8, Lower Hose #045..... \$19.95/ea.
- 1955-56 6-Cyl., Upper Hose #046..... \$17.95/ea.
- 1955-57 6-Cyl., Lower Hose #047..... \$19.95/ea.
- 1955-57 V8 in 6-Cyl. Pos., Lower. #10856..... \$17.95/ea.
- 1955-57 Upper, Trim to Fit X-Flow.. #12161 \$23.95/ea.
- 1955-57 Lower, Trim to Fit X-Flow.. #12162..... \$29.95/ea.

RADIATOR PETCOCK WITH HOSE

The same brass valve used in 1955, 1956 and 1957, with the original 6" of rubber drain hose included. **Made in the USA.**

- 1955-57 #400..... \$9.95/ea.



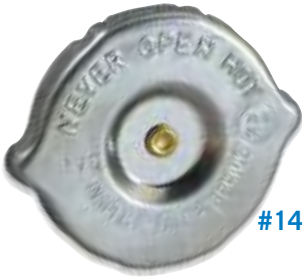

#141



#12160



#17107



#17105



#19377



#19378

RADIATOR CAPS

Fits the Desert Cooler® radiator or any other 1955-1957 radiator application. 7-pounds for stock cooling systems or 13-pounds pressure capacity for aluminum radiators with Vintage Air systems.

- 1955-57 7-lb. #141..... \$10.95/ea.
- 1955-57 13-lb. #12160..... \$7.95/ea.



RADIATOR CAPS WITH BE COOL LOGO

A great way to top off your cooling system upgrade. These Be Cool billet radiator caps, besides being great looking, are designed to allow the use of a coolant recovery system where needed.

- All Round Style #13776..... \$49.95/ea.
- All Octagon Style #13777..... \$49.95/ea.

BILLET SPECIALTIES POLISHED BILLET RADIATOR CAPS

These Billet Specialties radiator caps are CNC machined from 6061 T-6 billet aluminum. They are a two piece design so you can align it for maximum effect. Comes complete with a quality Stant 16lb radiator cap hidden under the billet shells which match their overflow tanks. NOTE: 7 lb. caps are for use with original heating and cooling systems made before 1966. 16 lb. caps are for use on modern heating and cooling systems made after 1966. **Made in the USA.**

- All Polished Bowtie, 16-lb..... #17105..... \$24.95/ea.
- All Polished Bowtie, 7-lb. #17106..... \$24.95/ea.
- All Polished Plain, 16-lb. #17107..... \$24.95/ea.
- All Polished Plain, 7-lb. #17108..... \$24.95/ea.
- All Black, Notch Grip 16-lb..... #19377..... \$38.95/ea.
- All Black, Plain Grip 16-lb..... #19378..... \$26.95/ea.

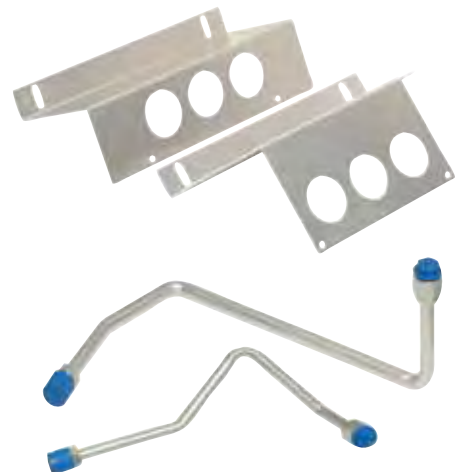

BE COOL A/C CONDENSER MODULE FOR CROSSFLOW RADIATORS

Designed to compliment their cross flow radiators this A/C condenser is a necessary part of your cross flow radiator conversion if you have air conditioning in your classic.

- 1955-57 Polished..... #18907..... \$799.95/ea.
- 1955-57 #18908..... \$649.95/ea.



COMPLETE 134A AIR CONDITIONING UNITS O/S

Designed specifically for your classic Chevy. System attaches to existing holes in dash and firewall without drilling. These kits now use the fully electronic GEN IV Sure Fit System, which features an electronic conversion for stock heater control levers which eliminates all control cables. Separate heating and cooling coils and SPAL permanent magnet blower motor gives you maximum capacity and performance. To order, call our customer service department with your application to be sure you are ordering the correct kit. These kits come in three box sets, and two of the three boxes need to be shipped oversized which incurs an extra shipping charge. **Note: The 55 with original 265 V8 with oil filter option requires a special order kit.**

1955-56	#2437	\$1469.95/kit
1957	#2439	\$1469.95/kit

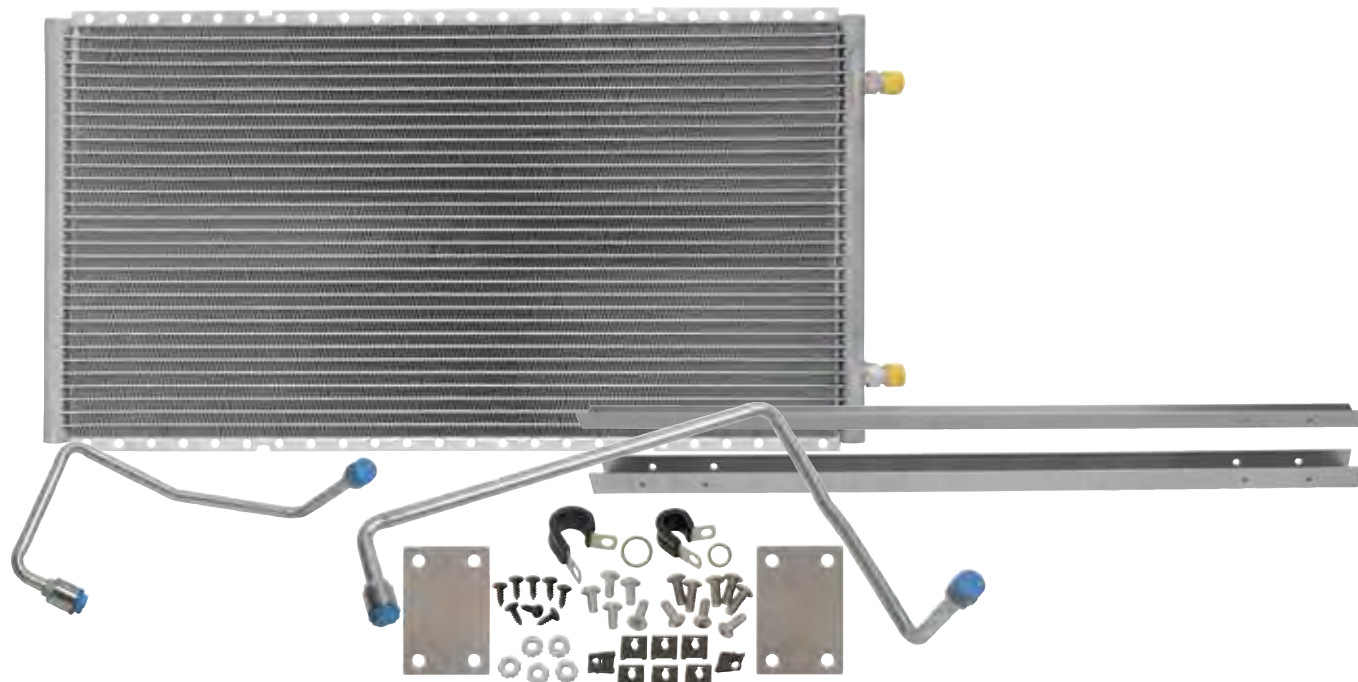

AIR CONDITIONING CONDENSER

For use with Crossflow radiators. Some fitting may be required.

1955-57 Unpolished, w/ Lines.....	#12169.....	\$359.95/ea.
-----------------------------------	-------------	--------------

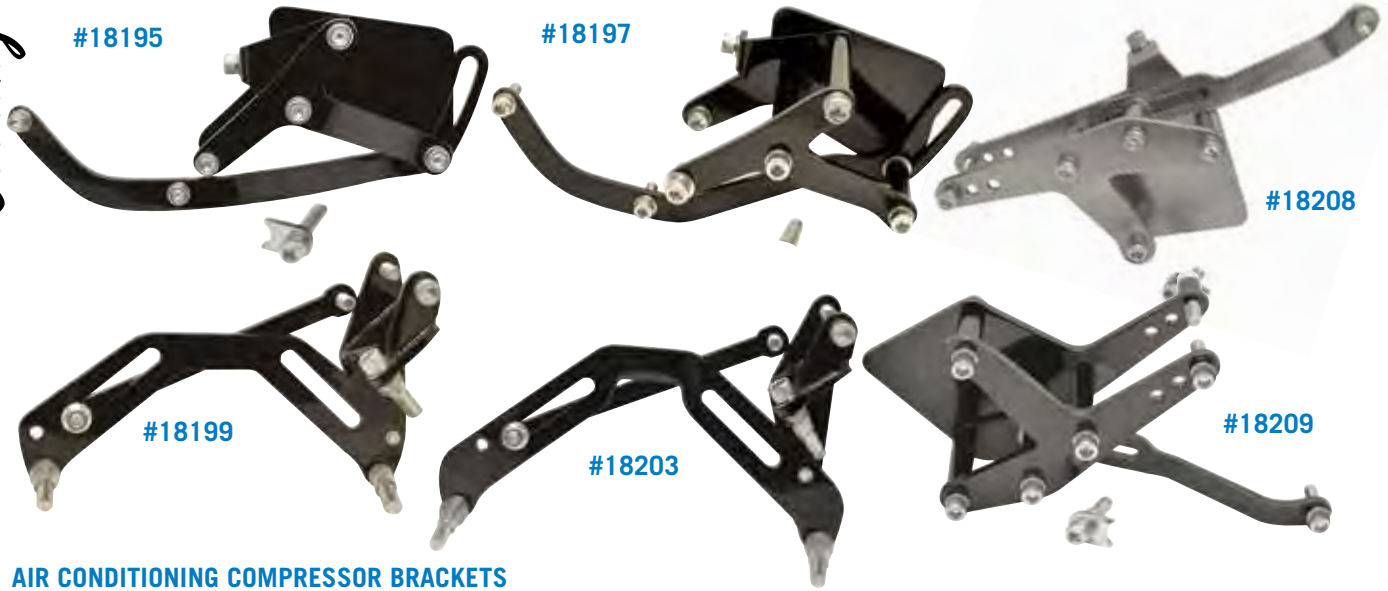

AIR CONDITIONING COMPRESSOR BRACKETS

All SB, Short Water Pump, Late Style Heads, Black.....	#18195.....	\$119.95/ea.
All SB, Long Water Pump, Late Style Heads, Passenger, Black	#18197.....	\$119.95/ea.
All BB, Short Water Pump, Passenger, Black	#18203.....	\$145.95/ea.
All SB, Short Water Pump, Late Heads, Passenger, Plain.....	#18208.....	\$124.95/ea.
All SB, Short Water Pump, Late Heads, Passenger, Black.....	#18209.....	\$139.95/ea.
All SB, Short Water Pump, Late Heads, Passenger, Chrome	#18210.....	\$199.95/ea.



#16544



#16542

AIR CONDITIONING CLUTCH COMPRESSOR COVERS FOR SANDEN 508

Dress up your Sanden 508 air conditioning Compressor with this aluminum clutch cover, hardware included.

All Chrome, SD508	#16542.....	\$79.95/ea.
All Polished, SD508.....	#16543.....	\$79.95/ea.
All Machined, SD508.....	#16544.....	\$79.95/ea.



AIR CONDITIONING AND ALTERNATOR BRACKET

All SB, Short Water Pump, Early Style Heads, Black	#18200.....	\$219.95/ea.
--	-------------	--------------



BILLET SPECIALTIES

AIR CONDITIONING CLUTCH COVER FOR SANDEN 508

All Polished.....	#17047.....	\$47.95/ea.
-------------------	-------------	-------------



AIR CONDITIONING COMPRESSOR CLUTCH COVER KITS FOR SANDEN SD7 ONLY.

Matches Front Runner pulleys.		
All Plain.....	#12544.....	\$47.95/kit
All Polished.....	#12545.....	\$61.95/kit

9. Steering & Suspension

SECTION AT A GLANCE:

Steering Wheels	392
Horn Related.....	398
Turn Signal & Related	399
Steering Column.....	401
Steering Box	409
Power Steering Related	410
Manual Steering	421
Front End	423
Suspension Systems	425
A-Arms	426
Traction Bars.....	428
Rear Ends.....	429
Differential	432
Leaf Springs.....	433
Shocks	435
Sway Bars.....	438
RideTech	440
Morrison Chassis	442
Roadster Shop Chassis.....	444
OE Style Chassis	446



FLAMING RIVER WATERFALL STEERING WHEELS

The Waterfall steering wheel from Flaming River offers a beautiful blend of classic design and modern billet elegance which looks right in just about any 5-6-7 Chevy. Waterfall steering wheels include the horn button assembly and are available in five different colors. Be sure to order the correct hub adapter for your column, #15151 is for Flaming River columns and #15152 is for late model GM and IDIDIT columns. Sorry adapters for original columns are not available.

All 13.8", Black	#15145.....	\$417.95/ea.
All 13.8", Slate Gray	#15146.....	\$417.95/ea.
All 13.8", Light Gray.....	#15147.....	\$417.95/ea.
All 13.8", Blizzard White.....	#15148.....	\$417.95/ea.
All 13.8", Light Tan	#15149.....	\$417.95/ea.
All Waterfall Hub Adapter, Flaming River Only	#15151.....	\$129.95/ea.
All Waterfall Hub Adapter, GM & Ididit Only.....	#15152.....	\$129.95/ea.



#17214

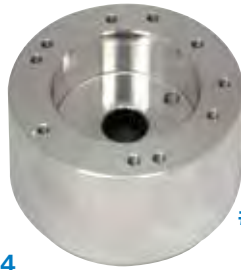

#17215



POLISHED 5/6-BOLT HUB ADAPTERS

All Flaming River Column	#17213.....	\$134.95/ea.
All 69-up GM & Ididit Column	#17214.....	\$134.95/ea.
All 67-Earlier GM Column.....	#17215.....	\$134.95/ea.



LECARRA HORN COVER ASSEMBLY

All SS/Hot Rod, Polished	#19478.....	\$54.95/ea.
--------------------------------	-------------	-------------



POLISHED 9-BOLT HUB ADAPTERS

All Flaming River Columns.....	#17210.....	\$119.95/ea.
All 69-up GM & Ididit Columns,	#17211.....	\$119.95/ea.
All Billet Specialties Wheels to Flaming River Column	#17212.....	\$139.95/ea.

#17211



#2422



#2410



#12172

LECARRA HORN BUTTONS

Part #2410 covers the mounting bolts on steering wheel. Parts #12172 and #12173 fit all 9-bolt hub adapters, except #12589A.

All Billet Polished	#2410.....	\$65.95/ea.
All Smooth Polished.....	#2422.....	\$59.95/ea.
All Black Plastic, Single Contact ..	#12172.....	\$16.95/ea.
All Black Plastic, Dual Contact	#12173.....	\$14.95/ea.



LECARRA STEERING WHEELS

Hand-crafted from the finest leather and high-grade aircraft aluminum, Lecarra steering wheels are of unsurpassed quality. One-piece aluminum frames are constructed of 6061-T6 billet. The leather is premium grade, hand-stitched in a flawless double baseball pattern. Steering wheels come with a mounting ring and a slotted screw set. Hub kits, shown below, are available in polished aluminum and powder coated black wrinkle finishes.

- | | |
|--|---|
| All 14", 4-Spoke Polished w/ Black Leather
..... #2417..... \$203.95/ea. | All 14", SS, Black #19476..... \$199.95/ea. |
| All 14", 4-Spoke Polished w/ Light Gray Leather
..... #2418..... \$203.95/ea. | All 14", Hot Rod, Black #19477..... \$199.95/ea. |
| All 14", 3-Spoke Polished w/ Black Leather (Shown)
..... #2415..... \$203.95/ea. | All 15", SS, Black #19481..... \$289.95/ea. |
| All 14", 3-Spoke Polished w/ Light Gray Leather
..... #2416..... \$203.95/ea. | All 15", Hot Rod, Black #19482..... \$289.95/ea. |



#19479 #19480

9-BOLT STEERING WHEEL HUB KITS FOR LECARRA STEERING WHEELS

For use with all Lecarra 9-bolt steering wheels. NOT for use with Flaming River or Grant steering wheels. For 49-66 applications use #1273 cancelling cam.

LECARRA 6-BOLT STEERING WHEEL HUB ADAPTERS

- | | |
|--|---|
| All SS #19479..... \$69.95/ea. | 1949-66 Black #2412..... \$89.95/kit |
| All Hot Rod #19480..... \$69.95/ea. | 1949-66 Polished Aluminum #2413..... \$89.95/kit |
| All Polished Aluminum, Pre-67 #19483..... \$69.95/ea. | 1967-92 Black #5101..... \$74.95/kit |

WARNING! Products on these pages may contain chemicals known to the State Of California to cause cancer and/or birth defects or reproductive harm. www.p65warnings.ca.gov



#17136*



#17137*



#17138*



#18009



#18008



#19380

BILLET SPECIALTIES STEERING WHEELS

Wheels feature milled finger notches for a ultra-comfortable grip. Wraps, horn buttons, and hub adapters are sold separately. Shown above with wraps on wheels. There are four components needed to properly install a Billet Specialties Steering Wheel: 1) Steering Wheel, 2) Wheel Wrap, 3) Horn Button and 4) Column Adapter.

All 15-1/2", Chicayne.....	#17136.....	\$274.95/ea.	All 15-1/2", Split Spoke	#18009.....	\$274.95/ea.
All 15-1/2", Outlaw	#17137.....	\$274.95/ea.	All 15-1/2", BLVD-03	#19379.....	\$254.95/ea.
All 15-1/2", Classic	#17138.....	\$274.95/ea.	All 15-1/2", BLVD-05	#19380.....	\$254.95/ea.
All 15-1/2", Fast Lane	#18007.....	\$274.95/ea.	All 15-1/2", BLVD-07	#19367.....	\$254.95/ea.
All 15-1/2", GTX01	#18008.....	\$274.95/ea.			



EXAMPLES WITH *ASTERISKS ARE SHOWN WITH WHEELS WRAPS THAT ARE SOLD SEPARATELY BELOW.

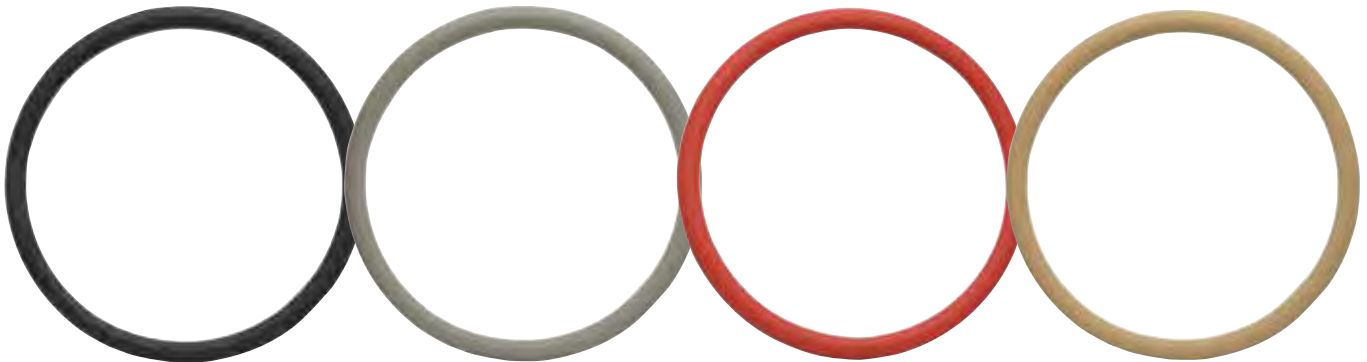

BILLET SPECIALTIES STEERING WHEEL WRAPS

All 15-1/2", Black.....	#17139.....	\$59.95/ea.	All 15-1/2", Light Gray	#17142.....	\$59.95/ea.
All 15-1/2", Red.....	#17140.....	\$59.95/ea.	All 15-1/2", Blank.....	#17143.....	\$49.95/ea.
All 15-1/2", Tan.....	#17141.....	\$59.95/ea.			



#17497

#17498



#17499

#17500



#17501

#17502

BILLET SPECIALTIES LOGO HORN BUTTONS

These Billet Specialties horn buttons are CNC machined from 6061 T-6 billet aluminum and polished to a mirror finish. These will fit any Billet Specialties steering wheel and other leading steering wheels that use 9 mounting holes. Made in the USA. Standard sized horn buttons leave the wheel mounting screws exposed, large buttons cover them up. Note: A complete Billet Specialties steering wheel is actually made up of 4 different parts. You choose your wheel design, you choose the color of the wrap you like, you choose a horn button and you choose the proper adapter to fit your steering column. You need one of each of these components to properly complete your wheel.

- All Standard #17497 \$54.95/ea.
- All Standard, Bowtie #17498 \$54.95/ea.
- All Large Logo #17499 \$54.95/ea.
- All Large, Bowtie #17500 \$69.95/ea.
- All Riveted, Polished Logo #17501 \$89.95/ea.
- All Smooth, Polished Logo #17502 \$94.95/ea.



BILLET SPECIALTIES HUB ADAPTERS

- 1949-66 GM Non-Tilt #17144 \$68.95/ea.
- 1967-94 GM Tilt #17145 \$54.95/ea.



GRANT HORN BUTTON TRIM RINGS

- All 5-Hole, Billet #15403 \$31.95/ea.
- All 5-Hole, Smooth #15404 \$31.95/ea.



GRANT HORN BUTTONS

- All Billet, 5-Hole, Plain #15399 \$39.95/ea.
- All Billet, 5-Hole w/ Bowtie #15400 \$45.95/ea.
- All Plastic, Red, White & Blue, w/ Bowtie #15401 \$24.95/ea.
- All Plastic, Red & Black, w/ Bowtie #15402 \$24.95/ea.



GRANT STEERING WHEEL INSTALLATION KITS

- All Black (55-68 Columns) #15395 \$69.95/kit
- All Polished (55-68 Columns) #15396 \$69.95/kit
- All Black (69-Up Columns) #15397 \$69.95/kit
- All Polished (69-Up Columns) #15398 \$69.95/kit



#15385



#15390



#18153



#15394



#18452



#18453

GRANT STEERING WHEELS

- | | | | | |
|---|--------------|--|-------------------|--------------|
| All 14.75", Heritage Deuce, Black #15385..... | \$379.95/ea. | All 13.75", 3-Spoke, Black Anodized Finish, Collectors | #18154..... | \$149.95/ea. |
| All 14.75", Heritage Deuce, Wood #15386..... | \$349.95/ea. | All 15", Formula GT, Silver Spokes, Black | #18452..... | \$161.95/ea. |
| All 14.75", Heritage Speed, Black #15387..... | \$369.95/ea. | All 15", Formula GT, Polished Spokes, Black | #18453..... | \$161.95/ea. |
| All 14.75", Heritage Diablo, Black #15389..... | \$179.95/ea. | All 15", Formula GT, Black Spokes, Black | #18454..... | \$161.95/ea. |
| All 14.75", Heritage Diablo, Wood #15390..... | \$179.95/ea. | | | |
| All 14", 3-Spoke, Black, w/ Holes. #15391..... | \$215.95/ea. | | | |
| All 14", 3-Spoke, Black, w/ Slots.. #15392..... | \$189.95/ea. | | | |
| All 14.5", 3-Spoke, Wood, w/ Holes | | | | |
| #15393..... | \$259.95/ea. | | | |
| All 14.75", 4-Spoke, Wood, w/ Slots | | | | |
| #15394..... | \$319.95/ea. | | | |
| All 13.5", Chevy Classic 3-Spoke . #18153..... | \$69.95/ea. | | | |



ORIGINAL STYLE 16-INCH RESTOMOD STEERING WHEELS

Built just like the original, only 2" smaller. Uses all the factory original or reproduction horn rings and components for easy replacement parts availability.

- 1955-56 Bel Air #17425..... \$249.95/ea.
- 1957 Bel Air, 210..... #17426..... \$249.95/ea.

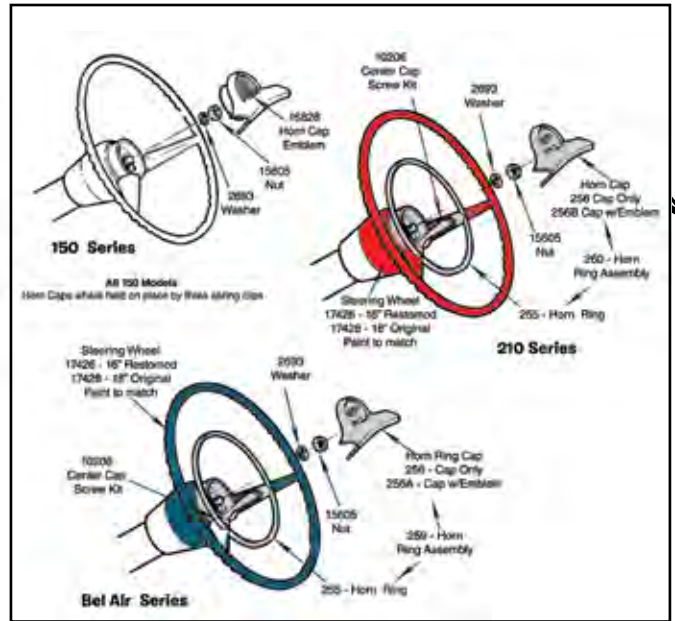

ORIGINAL 18-INCH STEERING WHEELS

Built like the original right down to the metal frame. Uses factory and reproduction horn rings and components.

- 1955-56 Bel Air #17427..... \$219.95/ea.
- 1957 Bel Air, 210..... #17428..... \$219.95/ea.

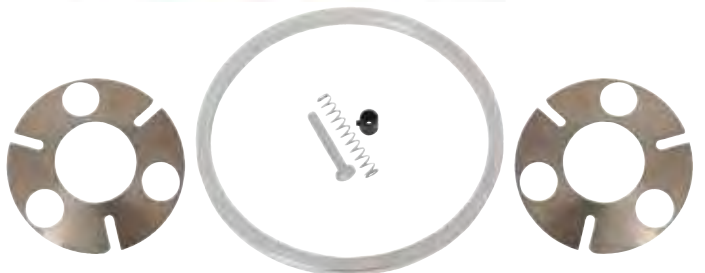

ORIGINAL STYLE STEERING WHEEL HORN ADAPTER KIT

For use with Ididit steering columns.

- 1955-57 w/ Ring #13279..... \$34.95/ea.



CUSTOM STEERING WHEEL

- 1959-60 Gloss Black..... #16810..... \$235.95/ea.



POLISHED, SHORT STEERING WHEEL HUB KITS

Will not work with



Flaming River or Grant steering wheels. 1955-66 applications use #1273 cancelling cams.

- 1955-64 2-1/4", w/o Button #12589..... \$76.95/ea.
- 1969-94 2", w/ Button #12589A... \$152.95/ea.



HORN RINGS

We could not be happier with the quality of these beautiful reproductions. Exactly like the originals except for the show quality prep and plating. **Made in the USA.**

1955-56 210	#1399.....	\$104.95/ea.
1955-56 Bel Air	#252.....	\$149.95/ea.
1957 210 & Bel Air	#255.....	\$149.95/ea.
1957 Assembly, Bel Air w/ Ring, Cap & Emblem	 #259.....	\$169.95/set
1957 Assembly, 210 w/ Ring, Cap & Emblem	 #260.....	\$169.95/set



1957 HORN CAPS

Our correctly reproduced horn cap assembles into the horn ring as smoothly as the original did in 1957. Fits Bel Air and 210 models. **Made in the USA.**

1957 Cap Only.....	#256.....	\$32.95/ea.
1957 Bel Air w/ Emblem.....	#256A.....	\$62.95/ea.
1957 210 w/ Emblem.....	#256B.....	\$62.95/ea.

1957 HORN CAP EMBLEMS

This injection moulded acrylic part is back-painted with a unique paint that gives the part a metallic look. Even the best original can't compare to a new one! **Made in the USA*.**

1957 Bel Air.....	#257*	\$35.95/ea.
1957 210.....	#258*	\$35.95/ea.
1957 150.....	#16828.....	\$59.95/ea.

HORN RING CENTER CAP SCREWS

These horn ring center cap screws often go missing when we start to restore our classics. Danchuk comes to the rescue with this new screw set.

1955-56 Bel Air	#10206.....	\$2.95/ea.
1957 210 & Bel Air	#10207.....	\$2.95/ea.



#1023

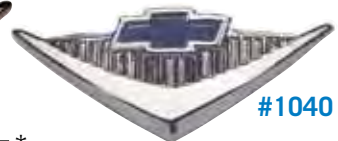

#1040

HORN CAP EMBLEMS *

Each emblem is die-cast and painted to correctly reproduce the original design. Bel Air emblems are gold toned and clear coated; emblems for the 210 are chrome plated.

1955-56 V8 Bel Air, Gold	#1023*	\$21.95/ea.
1955-56 V8 210, Silver.....	#1040*	\$21.95/ea.
1955-56 6-Cyl. Bel Air, Gold	#1053.....	\$20.95/ea.
1955-56 6-Cyl. 210, Silver.....	#1054.....	\$20.95/ea.



GEAR SHIFT ARM AND KNOB

Fits both standard and automatic transmissions. Correctly reproduced with quality plating and a sturdy black plastic knob.

1955-57 #1201..... \$26.95/ea.



TURN SIGNAL ARM AND KNOB

Like our gear shift arm and knob this part has been reproduced to original specifications.

1955-57 #900..... \$12.95/ea.

GEAR SHIFT PLASTIC KNOB

This top quality reproduction will get your gear shift looking like new.



1955-57 #899..... \$6.95/ea.



TURN SIGNAL PAWL KIT

Fix your non-returning turn signal arm with this sought-after repair kit.

1955-57 Best #580..... \$9.95/kit
 1955-57 Good, Pawls Only #16785..... \$3.95/kit



BEL AIR HORN RING CENTER CAPS

Comes with correct hardware.

Late 1955-56 Plain, w/ Holes #15462..... \$32.95/ea.
 Late 1955-56 Chrome, w/ Holes ... #15463..... \$55.95/ea.
 Late 1955-56 Chrome, w/o Holes #15465..... \$55.95/ea.

TURN SIGNAL MECHANISM

The turn signal mechanism is what the turn signal arm is attached to. Used with part # 1741, nylon bushing and rubber pads.



1955-57 #904..... \$10.95/ea.

HORN WIRE LEAD FOR AFTERMARKET COLUMNS AND WHEELS

All #17503..... \$8.95/ea.



TURN SIGNAL HOUSING LOCK PLATE

Installs between the turn signal mechanism and the shift collar. **Made in the USA.**



1955-57 #1240..... \$9.95/ea.

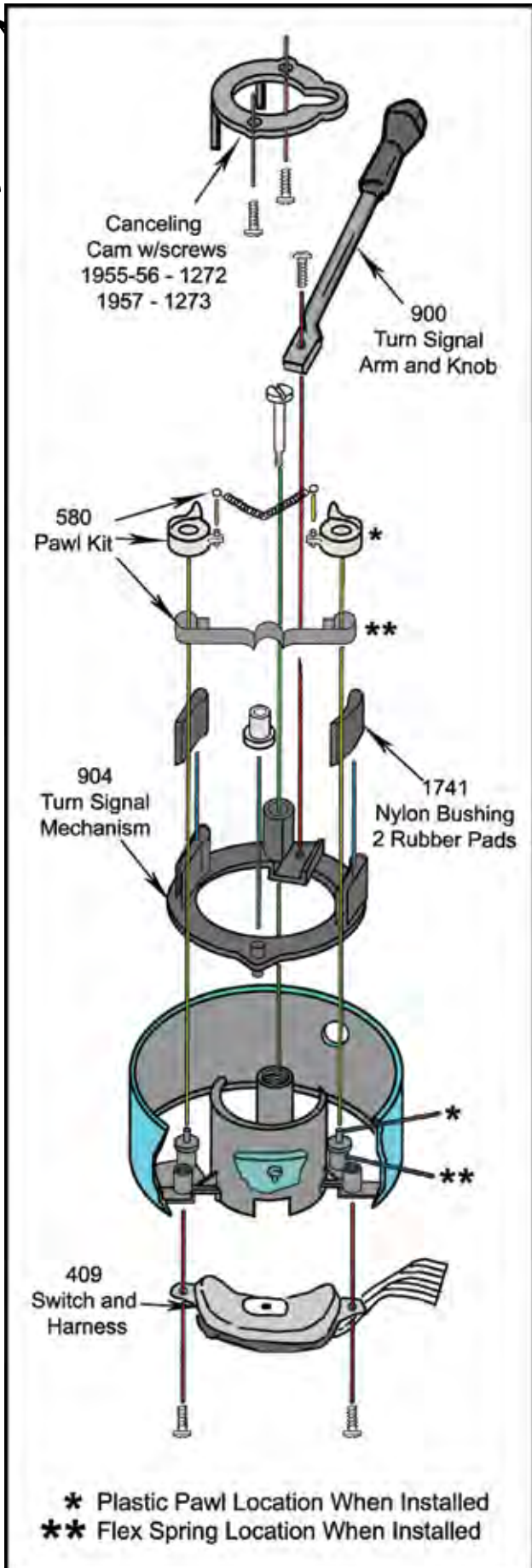

1957 STEERING COLUMN UPPER MOUNTING TO DASH SUPPORT KIT

Kit includes four rubber cushions, two sleeves, two bolts, and four washers.



1957 Upper..... #15989.....\$8.95/kit

STEERING WHEEL TO SHAFT NUT

This is the original style nut that always comes up missing, Be sure to order the washer #2693 to do the job right.



1955-57 #15605..... \$0.95/ea.

UNDER STEERING WHEEL NUT WASHER

1955-57 #2693..... \$0.50/ea.



STEERING COLUMN THRUST WASHER

These install under the turn signal lock plate and the shift collar. Use as needed.



1955-57 #12332..... \$2.95/ea.

STEERING COLUMN TANGED WASHER

1955-56 Under Shifting Housing .. #12703..... \$2.95/ea.



STEERING COLUMN FELT WASHER

Installs at the bottom of the column between the column and the column spring. Keeps dirt out of the steering column. Included in part # 1241.



1955-58 #12704..... \$3.95/ea.

RUBBER GEAR SHIFT GROMMET

1955-57 #836.....\$5.95/ea.



GEAR SHIFT ARM PIN

1955-57 #10163...\$3.95/ea.





TURN SIGNAL CANCELING CAMS

The turn signal pawl is tripped by the rotating canceling cam. When replacing the turn signal pawl, do not neglect this important cam. Without it in proper working order, even a new pawl cannot do its job.

1955-56 Best.....	#1272.....	\$10.95/ea.
1955-56 Good.....	#16805.....	\$6.95/ea.
1957-58 Best.....	#1273.....	\$10.95/ea.
1957-58 Good.....	#16806.....	\$6.95/ea.



STEERING COLUMN FLOOR SEALS

These seals are installed in an area that is susceptible to damage from heat. If your steering column floor seals have never been replaced, an inspection may reveal cracked and broken seals. These heavy gauge reproductions will last for years. Floor seals #597 through #600 need five firewall pad grommets (#611 or #17769), shown on page 95.

1955-56 Standard (Shown).....	#598.....	\$16.95/ea.
1955-56 Automatic.....	#597.....	\$16.95/ea.
1957 Standard (Shown).....	#600.....	\$16.95/ea.
1957 Automatic.....	#599.....	\$16.95/ea.
1957 Automatic w/ Power Brakes.....	#599A.....	\$16.95/ea.



TURN SIGNAL BUSHING AND RUBBER PADS

The turn signal bushing and rubber pads are installed into the #904, at left, turn signal mechanism and protect the turn signal pawl from undue wear.

1955-57	#1741	\$5.95/set
---------------	-------------	------------



STEERING COLUMN FIREWALL SEALS

Located between the firewall and the firewall pad, these seals bear the brunt of the engine heat at the steering column and require periodic replacement.

1955-57 Std.....	#232.....	\$18.95/ea.
1955-57 Auto.....	#233.....	\$18.95/ea.



TURN SIGNAL SWITCH WITH WIRING

You must re-use the plastic wire housing.

1955-57	#409.....	\$30.95/ea.
---------------	-----------	-------------



STEERING COLUMN-TO-DASH CUSHION

Made in the USA.

All 1955-56, 1957 Exported, Right Hand Drive Cars Only

.....	#838.....	\$5.95/ea.
-------	-----------	------------



GEAR SHIFT LEVER SPRING

1955-57	#1292.....	\$3.50/ea.
---------------	------------	------------

Steering

ALUMINUM STEERING COLUMN FLOOR MOUNTS

These mounts work with stock columns, Ididit columns and shortened stock floor shift columns. Mounts inside of car. May need to notch out for push rod on standard transmission cars.



- 1955-57 Polished..... #10178..... \$92.95/ea.
- 1955-57 Machined..... #10179..... \$82.95/ea.



CHROME STEERING BOX COVER

Just when you thought you chromed everything, there's always that last finishing touch. For stock boxes only. **Made in the USA.**

- 1955-57 Louvered #2526..... \$78.95/ea.

STEERING COLUMN

STEERING COLUMN BUSHING BEARING KIT

This kit will provide you with a quick and inexpensive way to eliminate that annoying up-and-down play in your steering wheel.



We have improved this part by adding more bearing surface, giving it longer life.

- 1955-57 (& 53-62 Vette) #008..... \$22.95/kit

STEERING COLUMN SHIFT COLLARS

Not only do we have the original design shift collar, but we also have a unique collar designed for floor-shifted cars. The collar is manufactured without the shifter hole, and with it installed, the old shift mechanism is out of sight. Both collars easily painted to match your car's interior color. 1957 version not available.



- 1955-56 Standard or Automatic ... #1110..... \$39.95/ea.
- 1955-56 Floor Shift #2081..... \$38.95/ea.

605 CHROME STEERING BOX COVERS

While the 605 box is a work of art, top off your conversion with a chrome steering box cover. **Made in the USA.**

- 1955-57 Louvered #2714..... \$108.95/ea.
- 1955-57 Ribbed #2715..... \$108.95/ea.



WIRING HARNESS SHIELD ON STEERING COLUMN

- 1955-56 #1929..... \$11.95/ea.



STEERING COLUMN SPRING ASSEMBLY

Installs at the bottom of the steering column above the shift levers.

- 1955-57 #1241..... \$9.95/set



FELT FLOOR SEAL

This installs inside the car under the steering column seal between it and the firewall seal. The clutch pedal rod goes thru this.



- 1955-57 Standard #867..... \$6.95/ea.

STEERING COLUMN UPPER SEAL

This seal is found around the steering column in front of the mount bracket. In most cases this rubber part is long gone or dried out and in need of replacement.



- 1955-56 #235..... \$5.95/ea.

STEERING COLUMN SPRING

- 1955-57 Lower..... #12702..... \$4.50/ea.





LOKAR BILLET ADJUSTABLE STEERING COLUMN SHIFT LINKAGE KIT

All 6L80E #18282..... \$79.95/kit



LOKAR BILLET ADJUSTABLE TRANSMISSION SHIFT ARM

Lokars Billet adjustable transmission shift arm for the 6L80E is the missing piece when installing GM's 6L80E transmission. It allows you to connect aftermarket shift linkages and get the correct ratio between shifter and the transmission. Shift linkage not included.

All 6L80E #18283..... \$65.95/ea.



STEERING COLUMN ASSEMBLY FASTENERS

1955-56 #2694..... \$22.95/kit
 1957 (Shown) #2695..... \$22.95/kit



STEERING COLUMN FIREWALL MOUNT PLATE

Designed to replace the original mount when installing a shortened original or aftermarket column.

1955-57 #14861..... \$45.95/kit

FIREWALL SEAL RETAINER CLIPS

Factory style firewall pad retainer clips come in 7-piece sets and are used to retain the pad and the steering column seals.

1955-56 7-Piece #17769..... \$18.95/set



PHOTO COURTESY OF GERTMAN2000

Steering

STEERING COLUMN



#1650



#1641



#1642



#1655

IDIDIT TILT STEERING COLUMN KITS

These columns are designed specifically for 1955-56-57 applications and come with four-way flashers. You have the option of with or without automatic transmission column shift. They come in paintable, chrome or black powder coated steel and brushed or polished aluminum. We have columns that will work with your stock steering box or your upgraded 500 or 605 box. Kit includes wire harness adapter, steering column coupler, lower mounting bracket, and billet steering column knobs. Easy to install. To use these columns with rack and pinion or Delphi 600 steering boxes (#15972) different couplers will be required. **Will not work with cast iron Powerglide transmissions.**



TILT, FLOOR SHIFT O/S

1955 Steel, Use w/ Stock Box	#1641\$659.95/kit
1955 Chrome, Use w/ Stock Box.....	#1642\$648.95/kit
1955 Brushed Alum., Use w/ Stock Box		
.....	#1643\$941.95/kit
1955 Polished Alum., Use w/ Stock Box		
.....	#1644\$864.95/kit
1955 Steel, Use w/ 500/605 Box.....	#1645\$705.95/kit
1955 Chrome, Use w/ 500/605 Box..	#1646\$737.95/kit
1955 Brushed Alum., Use w/ 500/605 Box		
.....	#1647\$998.95/kit
1955 Polished Alum., Use w/ 500/605 Box		
.....	#1648	..\$1006.95/kit
1955 Black, Use w/ 500/605 Box.....	#15650	..\$677.95/kit
1955 Black, Use w/ Stock Box	#15647	..\$648.95/kit
1956 Steel, Use w/ Stock Box	#1657\$659.95/kit
1956 Chrome, Use w/ Stock Box.....	#1658\$648.95/kit
1956 Brushed Alum., Use w/ Stock Box		
.....	#1659\$935.95/kit
1956 Polished Alum., Use w/ Stock Box		
.....	#1660\$864.95/kit
1956 Steel, Use w/ 500/605 Box.....	#1661\$705.95/kit
1956 Chrome, Use w/ 500/605 Box..	#1662\$737.95/kit
1956 Brushed Alum., Use w/ 500/605 Box		
.....	#1663\$998.95/kit
1956 Polished Alum., Use w/ 500/605 Box		
.....	#1664\$975.95/kit
1956 Black, Use w/ 500/605 Box.....	#15651	..\$677.95/kit
1956 Black, Use w/ Stock Box	#15648	..\$648.95/kit
1957 Steel, Use w/ Stock Box	#1673\$659.95/kit
1957 Chrome, Use w/ Stock Box.....	#1674\$648.95/kit
1957 Brushed Alum., Use w/ Stock Box		
.....	#1675\$864.95/kit
1957 Polished Alum., Use w/ Stock Box		
.....	#1676\$864.95/kit
1957 Steel, Use w/ 500/605 Box.....	#1677\$705.90/kit
1957 Chrome, Use w/ 500/605 Box..	#1678\$737.95/kit
1957 Brushed Alum., Use w/ 500/605 Box		
.....	#1679\$998.95/kit
1957 Polished Alum., Use w/ 500/605 Box		
.....	#1680	..\$1006.95/kit
1957 Black, Use w/ 500/605 Box.....	#15652	..\$677.95/kit
1957 Black, Use w/ Stock Box	#15649	..\$648.95/kit

TILT, COLUMN SHIFT O/S

1955 Steel, Use w/ Stock Box	#1649\$757.95/kit
1955 Chrome, Use w/ Stock Box	#1650\$965.95/kit
1955 Brushed Alum., Use w/ Stock Box		
.....	#1651	...\$1332.95/kit
1955 Polished Alum., Use w/ Stock Box		
.....	#1652	...\$1332.95/kit
1955 Steel, Use w/ 500/605 Box.....	#1653\$896.95/kit
1955 Chrome, Use w/ 500/605 Box..	#1654	...\$1044.95/kit
1955 Brushed Alum., Use w/ 500/605 Box		
.....	#1655	...\$1436.95/kit
1955 Polished Alum., Use w/ 500/605 Box		
.....	#1656	...\$1436.95/kit
1955 Black, Use w/ 500/605 Box.....	#15656	...\$957.95/kit
1955 Black, Use w/ Stock Box	#15653	...\$971.95/kit
1956 Steel, Use w/ Stock Box	#1665\$757.95/kit
1956 Chrome, Use w/ Stock Box.....	#1666\$965.95/kit
1956 Brushed Alum., Use w/ Stock Box		
.....	#1667	...\$1332.95/kit
1956 Polished Alum., Use w/ Stock Box		
.....	#1668	...\$1332.95/kit
1956 Steel, Use w/ 500/605 Box.....	#1669\$896.95/kit
1956 Chrome, Use w/ 500/605 Box..	#1670	...\$1044.95/kit
1956 Brushed Alum., Use w/ 500/605 Box		
.....	#1671	...\$1436.95/kit
1956 Polished Alum., Use w/ 500/605 Box		
.....	#1672	...\$1436.95/kit
1956 Black, Use w/ 500/605 Box.....	#15657	...\$957.95/kit
1956 Black, Use w/ Stock Box	#15654	...\$971.95/kit
1957 Steel, Use w/ Stock Box	#1681\$757.95/kit
1957 Chrome, Use w/ Stock Box.....	#1682\$965.95/kit
1957 Brushed Alum., Use w/ Stock Box		
.....	#1683	...\$1332.95/kit
1957 Polished Alum., Use w/ Stock Box		
.....	#1684	...\$1332.95/kit
1957 Steel, Use w/ 500/605 Box.....	#1685\$896.95/kit
1957 Chrome, Use w/ 500/605 Box..	#1686	...\$1044.95/kit
1957 Brushed Alum., Use w/ 500/605 Box		
.....	#1687	...\$1436.95/kit
1957 Polished Alum., Use w/ 500/605 Box		
.....	#1688	...\$1436.95/kit
1957 Black, Use w/ 500/605 Box.....	#15658	...\$957.95/kit
1957 Black, Use w/ Stock Box	#15655	...\$971.95/kit

STEERING COLUMN



IDIDIT NON-TILT STEERING COLUMN KITS O/S

We now offer Ididit column shift columns in a non-tilt version that places the wheel closer to the dash giving you big guys more room to move. Ididit columns are a replacement for your original column and feature self-canceling turn signals. Kits include the column, rag joint or coupler, floor mount and 4-way flasher adapter harness. Available in paintable steel, chrome or black powder coat. **Will not work with cast iron Powerglide transmissions.**

NON-TILT, COLUMN SHIFT STEERING COLUMNS O/S

1955 Steel, Use w/ Stock Box	#14707	\$669.95/kit
1955 Steel, Use w/ 500/605 Box..	#14708	\$719.95/kit
1955 Chrome, Use w/ Stock Box...	#14709	\$789.95/kit
1955 Chrome Use w/ 500/605 Box		
.....	#14710	\$849.95/kit
1955 Black, Use w/ 500/605 Box.	#15662	\$799.95/kit
1955 Black, Use w/ Stock Box	#15659	\$819.95/kit
1956 Steel, Use w/ Stock Box	#14711	\$669.95/kit
1956 Steel, Use w/ 500/605 Box..	#14712	\$719.95/kit
1956 Chrome, Use w/ Stock Box...	#14713	\$789.95/kit
1956 Chrome, Use w/ 500/605 Box		
.....	#14714	\$849.95/kit
1956 Black, Use w/ 500/605 Box.	#15663	\$799.95/kit
1956 Black, Use w/ Stock Box	#15660	\$819.95/kit
1957 Steel, Use w/ Stock Box	#14715	\$669.95/kit

NON-TILT, COLUMN SHIFT STEERING COLUMNS CONTINUED

1957 Steel, Use w/ 500/605 Box..	#14716	\$719.95/kit
1957 Chrome, Use w/ Stock Box...	#14717	\$789.95/kit
1957 Chrome, Use w/ 500/605 Box		
.....	#14718	\$849.95/kit
1957 Black, Use w/ 500/605 Box.	#15664	\$799.95/kit
1957 Black, Use w/ Stock Box	#15661	\$819.95/kit

NON-TILT, FLOOR SHIFT STEERING COLUMNS O/S

1957 Steel, Stock Box	#18924	\$425.95/kit
1957 Chrome, Stock Box.....	#18925	\$499.95/kit
1957 Black, Stock Box	#18926	\$499.95/kit
1957 Steel, 500/605 Box.....	#18927	\$479.95/kit
1957 Chrome, 500/605 Box	#18928	\$553.95/kit
1957 Black, 500/605 Box.....	#18929	\$553.95/kit

IDIDIT RHD (RIGHT HAND DRIVE) TILT STEERING COLUMNS O/S

Ididit has expanded their line of tilt steering columns to include columns for Right Hand Drive applications with a floor shift. No longer do you have to settle for a modified stock column for RHD vehicles.

1955-57 Floor Shift, Steel.....	#19167	\$542.95/ea.
1955-57 Floor Shift, Chrome	#19168	\$639.95/ea.
1955-57 Floor Shift, Black.....	#19169	\$639.95/ea.

DID YOU KNOW . . . WHEN YOU BUY AN IDIDIT STEERING COLUMN FROM DANCHUK, YOU ARE BUYING A KIT THAT INCLUDES EVERYTHING NEEDED TO INSTALL YOUR NEW COLUMN? SOME PLACES MAY ADVERTISE A LOWER PRICE, BUT ARE THEY SELLING A KIT THAT INCLUDES THE TURN SIGNAL ADAPTER OR THE CORRECT RAG JOINT OR THE FLOOR BRACKETS YOU WILL NEED? SOME ADVERTISED PRICES ARE FOR THE COLUMN ONLY. AT DANCHUK THESE PARTS ARE INCLUDED IN IDIDIT STEERING COLUMN KITS FOR YOUR PARTICULAR TRI-FIVE MODEL SO THERE IS LESS CONFUSION ON WHAT IS NEEDED TO INSTALL.



#19008



STEERING COLUMN DRESS-UP KITS

- All Chrome, Standard Tilt..... #19006..... \$56.95/kit
- All Black, Standard Tilt #19007..... \$56.95/kit
- All Black, Retro Tilt..... #19008..... \$65.95/kit



IDIDIT SHIFT KNOBS

- All Chrome, Standard #19009..... \$32.95/ea.
- All Black, Standard #19010..... \$32.95/ea.



IDIDIT COLUMN RETRO DRESS-UP KITS

- All Chrome, Tilt..... #17033..... \$66.95/kit
- All Black, Non-Tilt..... #17551..... \$51.95/kit
- All Chrome, Non-Tilt..... #17550..... \$51.95/kit



IDIDIT RETRO SHIFT KNOBS

- All Chrome #17548..... \$36.95/ea.
- All Black #17549..... \$36.95/ea.



#16830



#16949

STEERING COLUMN BRACKETS

Part #16830 is the bracket that mounts on the dash ABOVE the steering column and is required to properly mount the steering column. Part #16949 is the lower bracket that goes below the column when it is mounted into the dash.

- 1955-56 Upper..... #16830..... \$21.95/ea.
- 1955-56 Lower..... #16949..... \$31.95/ea.

1957 LOWER STEERING COLUMN BRACKET

This bracket is required for mounting the column to the dash in all 1957's.



- 1957..... #17680..... \$29.95/ea.



1957 STEERING COLUMN COVER BRACKET

- 1957..... #17599..... \$11.95/ea.

SHIFT COLUMN LEVER LINKAGE BUSHING

Just a little wear on this important bushing and your shift linkage will feel sloppy. Replacing this bushing will solve the problem and may spare you from more repairs. See the Transmission section for more shift linkage related parts.



- 1955-57 #1178..... \$6.95/ea.



STEERING COLUMN DRESS-UP KIT

For Ididit and Flaming River.

- All Billet, Black #14826..... \$64.95/kit



FLAMING RIVER STAINLESS STEEL, TILT STEERING COLUMNS O/S

Flaming River columns feature a stainless steel housing that's available in either a paintable mill finish or a eye catching polished finish. Flaming River columns are sold "a la carte" so you will need to order harness, coupler and floor mount separately. **Will not work with cast iron Powerglide transmissions.**

1955-56 Column Shift.....	#14657.....	\$689.95/ea.
1955-56 Column Shift, Polished.....	#14658.....	\$813.95/ea.
1955-56 Floor Shift.....	#14659.....	\$434.95/ea.
1955-56 Floor Shift, Polished.....	#14660.....	\$592.95/ea.
1957 Column Shift.....	#14661.....	\$789.95/ea.
1957 Column Shift, Polished.....	#14662.....	\$839.95/ea.
1957 Floor Shift.....	#14663.....	\$530.95/ea.
1957 Floor Shift, Polished.....	#14664.....	\$742.95/ea.
1957 Column Shift w/ Indicator.....	#14665.....	\$999.95/ea.



1957 FLAMING RIVER GEAR SHIFT LENSES

For use with Flaming Rivers 1957 column #14665.

1957.....	#14671.....	\$26.95/ea.
1957 Overdrive.....	#14672.....	\$26.95/ea.



FLAMING RIVER RAG JOINT

For use with Flaming River columns only.
All 3/4" DD Male, 3/4-30 Spline ... #14669..... \$139.95/ea.

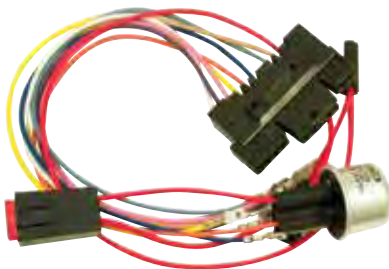

FLAMING RIVER STEERING COLUMN HARNESS FLASHERS

1955.....	#14666.....	\$36.95/ea.
1956.....	#14667.....	\$36.95/ea.
1957.....	#14668.....	\$36.95/ea.



STEERING COLUMN STAINLESS U-JOINT

All Stock Steering Box, 1" DD x 3/4" DD
..... #14676..... \$115.95/ea.



ORIGINAL STEERING COLUMNS, SHORTENED FOR 605/500 BOX

Finally a column that doesn't require an exchange! These new columns are manufactured for factory column shift automatics that are upgrading to a 500/605 power steering system. These new column kits feature an improved shift lever design that gives you added firewall clearance and also includes a new shaft and newly designed floor mount plate. These columns are not for use with rack and pinion systems. **Columns will not work with Rack-n-Pinion systems and cast iron Powerglide transmissions.**

1955-56	#12073.....	\$234.95/ea.	1955-56 for Borgeson Box	#15975.....	\$249.95/ea.
1957.....	#12074.....	\$209.95/ea.	1957 for Borgeson Box	#15976.....	\$249.95/ea.



STEERING BOX MAJOR REBUILD KITS WITH SHAFTS O/S

These major rebuild kits include all necessary components to completely rebuild your original Tri-5 long input shaft manual steering box. Available in the standard 24:1 ratio or a performance oriented 16:1 ratio. Detailed instructions included but some specialty tools will be required.

1955-57 24:1	#18731.....	\$379.95/kit
1955-57 16:1	#18732.....	\$599.95/kit



STEERING BOX REBUILD KIT

Includes the required parts and instructions to freshen up your original steering box.

1955-57	#16818.....	\$109.95/kit
---------------	-------------	--------------



605/500 STEERING BOX HOSE KIT CONVERSION

For use with steering boxes and pumps with inverted seat fittings.

1955-57	#2699.....	\$64.95/kit
---------------	------------	-------------

STOCK STEERING COLUMN RAG JOINT FOR 605/500 BOX

Needed when modifying stock column for use with 605/500 box.

1955-57	#10149.....	\$48.95/ea.
---------------	-------------	-------------



SHIFT LINKAGE ADJUSTMENT SWIVEL NUT

Automatic transmissions require one, while manuals require two.

1955-57	#1175.....	\$10.95/ea.
---------------	------------	-------------



500 SERIES POWER STEERING BOXES

Designed around Delphi's 670 Series power steering box, the 500 Series offers better reliability, road feel and quicker steering response than older 605 boxes. With the 500 Series box you get a completely new assembly that is 100% factory tested, instead of a 20-year-old rebuilt unit. This insures you long term performance and reliability that was never available before. The 500 Series is a direct replacement for the 605, and it uses the same components as the 605. So, whether you are adding power steering to your car or replacing an old, tired 605 box, look no further. The 500 box requires hoses with inverted seat fittings. Original column **MUST** be modified. See parts #12073-12074 for new shortened columns.

1955-57 New, 14:1 Ratio #13197..... \$439.95/ea.
 1955-57 New, 14:1 Ratio, Chrome #14980... \$1099.95/ea.



POWER STEERING PITMAN ARM

For factory power steering only.

1955-57 #12603..... \$58.95/ea.



MANUAL STEERING PITMAN ARM

Replacement arm for original manual steering boxes. Will also work with 500 series power steering conversion boxes #13197, #14980 and the Delphi 600 box, #15972.

1955-57 #13870..... \$41.95/ea.

DELPHI 600 POWER STEERING CONVERSION BOX

The Borgeson conversion box is a remanufactured GM Delphi 600 integral power steering gearbox and represents the latest generation of integral power steering gearbox technology with true modern power steering feel, feedback and a sporty 12.7:1 ratio.

This box will bolt directly to the factory mounting location and will fit the stock pitman arm. Cars with factory power steering will require a drag link adapter. This box has 18 DD shaft. See rag joints below. **Made in the USA.**

1955-57 REMAN, 12.7:1 Ratio #15972..... \$459.95/ea.



#15973



#17699

RAG JOINTS

Use this rag-joint when installing the Borgeson 600 steering box #15972 with a column shift style Ididit column. All 18mm DD x 3/4"-36 #15973..... \$111.95/ea.

Use this rag-joint when installing the Borgeson 600 steering box #15972 with either a Flaming River column or a floor shift style Ididit column. All 18mm DD x 1" DD..... #15974 \$111.95/ea.

For use on steering box, part #15972 steering boxes and modified factory columns.

All 18 mm DD X 3/4" DD #17699..... \$111.95/ea.



POWER STEERING PITMAN ARM BALL STUD

1955-57 #12375..... \$19.95/ea.



UNISTEER RACK AND PINION POWER STEERING CONVERSION KITS O/S

The Unisteer rack and pinion conversion kit is the only kit on the market engineered with the correct steering geometry for the Tri-Five Chevy suspension. It bolts in using existing chassis and steering holes and is designed to work with any engine, small block, big block or LS. The kit contains mounting brackets, steering gear, tie rod ends, steering arms, installation hardware and complete instructions. Custom headers and oil pan may be needed for some applications. For better road feel and more steering effort a low flow/volume rated power steering pump is recommended. Available in black powder coat or a stunning chrome finish. Original column modification will be required. You cannot retain column shift when using a modified original style column, an Ididit or Flaming River column must be used to retain a column shift.

1955-57	#17755.....	\$974.95/kit
1955-57 Chrome	#17755A.....	\$1199.95/kit



RACK AND PINION POWER STEERING BRAIDED STAINLESS HOSE KIT

For rack and pinion steering kits with Saginaw pumps. Will work with TC Type II pumps by changing the pressure fitting to either parts #12570 or #12571, on page 416. See part #12567, on page 417 for 500/605 applications.

1955-57	#12574.....	\$141.95/kit
---------------	-------------	--------------



RACK AND PINION BRAIDED HOSES

3-Piece set. Works with reservoir parts #12667 or #12668 on page 418.

1955-57 TC Pump w/ Remote Reservoir	#15486.....	\$194.95/ea.
---	-------------	--------------



PITMAN ARM TO STEERING BOX NUT

1955-57	#2691.....	\$4.95/ea.
---------------	------------	------------



PITMAN ARM TO STEERING BOX LOCK WASHER

1955-57	#2692.....	\$5.95/ea.
---------------	------------	------------



RACK AND PINION POWER STEERING COLUMN U-JOINT KITS

U-joint kits designed for small block applications only.

1955-57 Stock Column	#12573.....	\$224.95/kit
1955-57 Ididit Column w/ Splined Shaft	#12573A.....	\$224.95/kit

WARNING! Products on these pages may contain chemicals known to the State Of California to cause cancer and/or birth defects or reproductive harm. www.p65warnings.ca.gov



BILL'S HOT ROD SAGINAW POWER STEERING PUMP BRACKETS

Bill's Hot Rod Saginaw power steering pump brackets are a perfect match for other Bill's Hot Rod alternator and air conditioning brackets.

- All SB, Bare..... #12554* \$68.95/ea.
 - All SB, Chrome #12555* ... \$129.95/ea.
 - All SB, Black #18201 \$89.95/ea.
 - All BB, Short Water Pump, Bare #12560..... \$77.95/ea.
- *Note: Fits both short and long water pump applications.



TYPE II POWER STEERING PUMP BRACKETS

This stamped steel bracket is for use with GM's new Type II/TC pumps.

- All SB w/ Short Water Pump #15939..... \$124.95/ea.
- All BB w/ Short Water Pump #15940..... \$124.95/ea.
- All SB w/ Long Water Pump #15941 \$124.95/ea.



CPP POWER STEERING PUMP BRACKETS

These power steering pump brackets are designed so you can mount the power steering pump in either a high or low position depending on your situation. Works best when used with an alternator that has been mounted to the inside of the valve cover. Not recommended for use with an exhaust mounted alternator. Will work for both short and long water pump applications.

- All SB, Black #18728..... \$49.95/ea.
- All SB, Chrome #18729..... \$59.95/ea.



POWER STEERING PUMP MOUNT BRACKET

Fits small blocks and Saginaw pumps only. Front motor mount bracket is integrated, and can be used with both front and side mounts. This bracket replaces the original front motor mount bracket.

- 1955-57 V8 #2684..... \$49.95/ea.



TC TYPE P/S PUMP BRACKETS

Both brackets use existing accessory-bracket mounting holes in your engine block. The small block bracket is designed to work with many pulley configurations and a "short" style water pump, but can be adapted to a "long" style pump with the use of spacers. The big block bracket is designed to work with the "long" style water pump.

- All SB..... #13375..... \$83.95/ea.
- All BB..... #13376..... \$84.95/ea.



#13405



#19055

TC TYPE POWER STEERING PUMPS

Part #12569 should be used with a remote reservoir and the housing is machined for -6 and -10 AN fittings, which are included. Compatible with 605 and 500 boxes and rack and pinion conversions. A low flow pump will give your rack and pinion more road feel and steering effort. Requires remote reservoir parts #12667 and #12668 on page 418. **Note: For use with Part #12570 Pressure Tube or Banjo fitting, shown on page 416.**

All Aluminum, w/o Reservoir.....	#12569.....	\$224.95/ea.
All Aluminum, For use w/ OE Reservoir	#13405.....	\$179.95/ea.
All Satin, Rack & Pinion, Low Flow	#14191.....	\$174.95/ea.
All Polished, Rack & Pinion, Low Flow	#14192.....	\$249.95/ea.
All Satin, Low Flow w/ Reservoir	#17174.....	\$224.95/ea.
All Polished, Low Flow w/ Reservoir.....	#17175.....	\$359.95/ea.
All Satin, -6AN, Hi Flow w/ Reservoir	#19055.....	\$279.95/ea.

BILLET SPECIALTIES POLISHED POWER STEERING TC PUMP BRACKETS

Billet Specialties type II power steering bracket with pulley is precision machined from 6061-T6 billet aluminum and mounts low on the driver's side of the motor. Engineered to work with GM type II remote power steering pumps and requires the use of a 3-groove crank pulley.



All SB, Short Water Pump (Shown).....	#18004.....	\$179.95/ea.
All SB, Long Water Pump.....	#18005.....	\$179.95/ea.
All BB, Short Water Pump.....	#18006.....	\$179.95/ea.



#18212

#18211

#18213

BILL'S HOT ROD POWER STEERING WIDE SET BRACKETS

All SB, Short Water Pump, Plain	#18211.....	\$74.95/ea.
All SB, Short Water Pump, Black	#18212.....	\$86.95/ea.
All SB, Short Water Pump, Chrome.....	#18213.....	\$119.95/ea.

Steering

POWER STEERING



POWER STEERING PUMP PULLEYS

For Saginaw pumps only, bolt-on style.

All 1-Groove, Polished Billet, Bolt-On
 #12477 \$39.95/ea.

For TC Type pumps, press-on.
All 1-Groove, Polished Billet, Press-On
 #13407 \$79.95/ea.

POWER STEERING PULLEY

Part #	Shaft Size	Key	Press	1st Groove B	2nd Groove C	Diameter D	1st Groove E	2nd Groove F	Suggested Applications
15556	5/8"	Yes	No	2.175	-	5-3/4"	-320	-	PS Only
15557	5/8"	Yes	No	1.07	2.175	5-3/4"	-320	-.940	PS and AC
15558	5/8"	Yes	No	1.05	-	5-3/4"	-330	-	AC
12477	5/8"	Yes	No	2.175	-	5-3/4"	-320	-	PS Only
13407	5/8"	No	Yes	2.175	-	5-3/4"	-320	-.940	PS Only

PS - Power Steering Systems; PS and AC - Power Steering and Air Conditioning Systems; AC - Air Conditioning Systems

POWER STEERING PUMP PULLEYS

This pulley works on either small or big blocks with a short or long water pump and replaces GM# 3770509. The groove lines up to the outer groove on the 3-groove crank pulley with short water pump and on the inner groove on 2-groove long water pump applications.

All 1-Groove, Steel..... #15558..... \$39.95/ea.

This pulley works on either small or big blocks with a short or long water pump and replaces GM# 3941107.

The grooves line up to either outer or middle groove on 3-groove crank pulley with short water pump and on the inner and middle groove on 3-groove crank pulley on long water pump applications.

All 2-Groove, Steel..... #15557..... \$45.95/ea.

This pulley works on either small or big blocks with a short or long water pump and replaces GM# 3834720.

The grooves line up to the middle groove on 3-groove crank pulley with short water pump and on the inner groove on 3-groove crank pulley on long water pump applications.

All Back-Spaced, 1-Groove..... #15556..... \$38.95/ea.

BILLET SPECIALTIES

BOLT-ON POWER STEERING PULLEYS

All 1-Groove, Polished #17059..... \$75.95/ea.
All 2-Groove, Polished #17060..... \$74.95/ea.



SAGINAW POWER STEERING PUMP KIT

Replaces factory power steering pump/generator assembly when converting to an alternator. Also works with kit #12275, 605/500 and rack and pinion conversions.

1955-57 #13571..... \$374.95/kit



SAGINAW POWER STEERING PUMP WITH DOUBLE PULLEY

Compatible with 605/500 boxes and rack and pinion conversions. Uses hoses with inverted flare fittings.

1955-57 #10148..... \$192.95/ea.

POWER STEERING/GENERATOR PUMP RELOCATION BRACKET

Relocates factory power steering generator assembly to clear late model power brake booster conversions with dual reservoir master cylinder.

1955-57 #13527..... \$22.95/ea.



CHROME SAGINAW POWER STEERING PUMP

Chrome plated pump assemblies come with chrome plated reservoirs, billet caps and are available with black or red pump body. Requires bolt-on style pulley, which is not included. Uses hoses with inverted flare fittings.

All w/ Billet Cap, Black Body #14313..... \$179.95/ea.

POWER STEERING PUMP ADAPTER FITTING AND HOSE END FOR SAGINAW BOX

This adapter kit is for use with Saginaw steering boxes to adapt from a -6AN hose to 5/8-18 inverted flare. Kit includes the adapter and a hose end for -6AN hose. Will work on any Saginaw style steering box.

1955-57 #12660..... \$37.95/kit



POWER STEERING PUMP TO VALVE HOSE SETS

Part #13572 works with OE pumps. Part #13573 works with late model Saginaw pump kit, part #13571, shown above. Both are for use with replacement control valves.

1955-57 #13572..... \$119.95/set

1955-57 #13573..... \$119.95/set



1955 POWER STEERING/GENERATOR MOUNTING HARDWARE KIT

1955..... #13562..... \$11.95/kit



OE POWER STEERING PUMP CAM PACK KIT
 1955-57 #13526..... \$329.95/kit



OE POWER STEERING PUMP CAM RING
 1955-57 #13574..... \$209.95/ea.

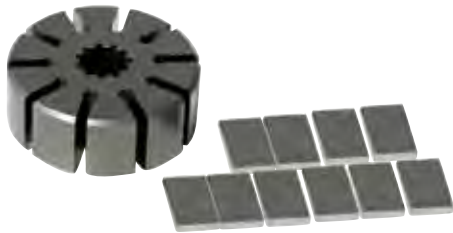

OE POWER STEERING PUMP VANES AND ROTORS
 1955-57 Kit #13566..... \$129.95/kit
 1955-57 Vane Only #13567..... \$49.95/set
 1955-57 Rotor Only #13568..... \$82.95/ea.

OE POWER STEERING PUMP PRESSURE PLATE

The power steering pump pressure plate installs between the cam ring and the pump cover assembly and is sealed by an O-ring that installs inside the cover assembly.



1955-59 #18665..... \$59.95/ea.

SAGINAW POWER STEERING PUMP RESERVOIR CAPS

Replacement reservoir cap for Saginaw type power steering pumps such as our part #10148. Black or Chrome.



All Black #16527..... \$8.25/ea.
 All Chrome #16528..... \$9.95/ea.



HARDLINE PRESSURE TUBE

For use with TC type Pumps and recommended for Front Runner Systems. Note: For use with parts #12568 or #12569 pumps.

All w/ Banjo Bolt #12570..... \$91.95/ea.

BANJO PRESSURE FITTING

Recommended for use with Front Runner systems. For use with TC type pumps.



All #12571 \$27.95/ea.



#19305



#16530

POWER STEERING PUMP PRESSURE REDUCTION FITTINGS

These fittings replace the pressure ports of our steering pumps and reduces the flow from 3 gallons per minute to two gallons per minute. The reduction in flow may be preferred by those of you who want more effort in the steering.

All Saginaw #16530 \$18.95/ea.
 1955-57 Type II, 6AN Male, Low Flow #19305..... \$26.95/ea .
 1955-57 Type II, O-Ring Hoses, Low Flow #19304..... \$29.95/ea.

POWER STEERING PUMP CONVERSION FITTING

This fitting converts your inverted flare Saginaw power steering pump pressure port to a male -6AN fitting. For those who are making their own power steering lines using -AN fittings.



All -6AN #16529..... \$15.95/pr.

SAGINAW POWER STEERING PUMP HARDWARE KIT

This 3-piece set has those hard to find pieces to repair/replace or swap out any of the pump hardware that is used to mount your pump. SAE threads.



All #16526 \$9.95/ea.



BILLET SPECIALTIES POWER STEERING HOSE KIT WITH FITTINGS

All..... #17062..... \$229.95/kit



POWER STEERING HOSE

This power steering hose is for use with original control valves and later model Saginaw P-style pumps.

1955-57 Assist to Late Model Pump
..... #15062..... \$124.95/ea.



STAINLESS BRAIDED POWER STEERING HOSE KIT

For use with 500/605 conversions with Saginaw pumps. Will work with TC Type II pumps by changing the pressure fitting to either parts #12570 or #12571 on page 416.

All w/ 500/605 Boxes #12567 \$149.95/kit



STAINLESS POWER STEERING HOSES

Part #13685 is for use with part #12667-68 or other remote reservoir application, shown on page 418.

All GM Boxes w/ Mini-Res #13684..... \$209.95/ea.
All GM Boxes w/ Remote-Res #13685..... \$265.95/ea.



POWER STEERING PUMP FLOW CONTROL VALVE KIT

All Saginaw Pump..... #13395..... \$18.95/kit



POWER STEERING HOSE SETS

Reproduced to the correct lengths with the correct fittings, these hoses are the only solution for those rotting vintage originals. These top quality sets are the best on the market! Set of four.

1955-57 6-Cyl..... #17403..... \$105.95/set
1955-57 V8 #243..... \$105.95/set

POWER STEERING PUMP ADAPTER

For use on Saginaw pumps.

All Male to 5/8-18 Inverted Flare.. #14353..... \$9.95/ea.





BILLET, TC TYPE POWER STEERING PUMP RESERVOIRS

- All Custom Color #17530..... \$269.95/ea
- All Machined #17531..... \$258.95/ea
- All Polished..... #17532..... \$287.95/ea



TC TYPE POWER STEERING PUMP BILLET RESERVOIRS

Billet Specialties pump mount billet reservoir features threaded double O-ring reservoir and hose attachments to provide secure leak free service, internal baffling eliminates foaming and it is topped off with a vented notch grip cap.
All Polished..... #17789..... \$289.95/ea.
All Black #17790..... \$277.95/ea.

REMOTE POWER STEERING RESERVOIRS

Reservoirs are 6" x 3" and have screw off caps with an O-ring seal. Inlet fitting is -6AN and outlet fitting is -10AN. Order part #13685, shown on page 417, hose kit for proper installation. Also works with hose kit, #15486.



- All Polished..... #12667..... \$214.95/ea.
- All Machined..... #12668..... \$197.95/ea.



POWER STEERING REMOTE RESERVOIR

See page 386 for matching coolant overflow tank.
1955-57
 #19306 \$169.95/ea.

OE PLASTIC POWER STEERING RESERVOIR

For use with TC type pumps.
All..... #13406. \$52.95/ea.

ALUMINUM REMOTE RESERVOIRS FOR HYDROBOOST

Aluminum Remote Reservoirs for Hydro-Boost type applications same as above but have an additional -6AN fitting for the return line running from the booster unit providing a cleaner install.



- All Machined #17832..... \$165.95/ea.
- All Polished..... #17833..... \$185.95/ea.



POWER STEERING CONTROL VALVE WITH HOSES

This complete bolt-on kit consists of all new parts with no modifications necessary to the center link, pitman arm, hoses or frame. The valve replaces the original power steering valve or the original valve can be reinstalled at a later date.

1955-57 #12275..... \$459.95/kit

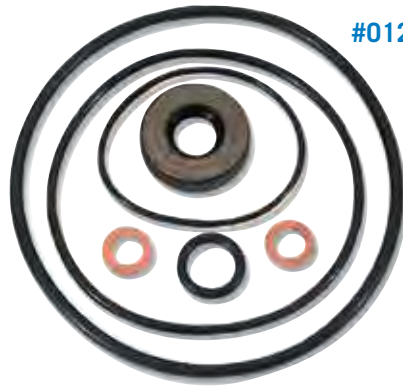

#012



#010



#011

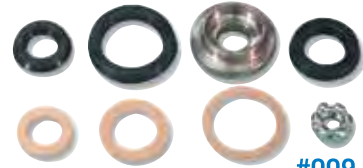

#009

POWER STEERING REBUILD KITS

Each kit contains all the seals and hardware necessary to restore the smooth operation of your power steering system. Kits are designed for all 5-6-7 models. #010 for use with factory power cylinder using 1/2" shaft.

- 1955-57 Control Valve Kit..... #009.....\$19.95/kit
- 1955-57 Cylinder Kit #010.....\$18.95/kit
- 1955-57 Cylinder Mounting Kit #011.....\$14.95/kit
- 1955-57 Pump Kit #012.....\$16.95/kit



POWER STEERING FILTER KITS

Contamination in the power steering system can lead to premature failure and excessive wear. These in-line CPP filter kits are exactly what you need to keep your system contaminant free.

- All Push-on, 3/8" #18680.....\$19.95/kit
- All AN-6 #18681.....\$14.95/kit

POWER STEERING HOSE GROMMET FRAME BRACKET

Used with part #819, this bracket helps to keep your power steering hoses away from the exhaust.

1955-57 #973..... \$12.95/ea.



MAGNA-PURE IN-LINE POWER STEERING FILTER

In-line power steering filters remove contamination which could cause premature power steering failure. The Magna-Pure filter uses patented by-pass filtration technology and a magnetic filter element to trap debris before it can clog your power steering system.

All 3/8" #18025..... \$25.95/ea.



POWER STEERING BOX O-RING FITTINGS

For use on 600 series power steering boxes.

- All Male to 16mm x 1.5, -6 AN #14354..... \$6.95/ea.
- All Male to 18mm x 1.5, -6 AN #14355..... \$12.95/ea.

POWER STEERING HOSE GROMMET

This grommet mounts into the grommet frame bracket #973 and keeps the power steering hoses away from the exhaust.

1955-57 #819..... \$4.95/ea.





FACTORY POWER STEERING CENTERLINK

This part attaches to the power steering control valve and connects the tie rod ends to the steering gear. It's supported on the passenger side with the idler arm and drivers side with the pitman arm.

1955-57 #12602..... \$199.95/ea.



POWER STEERING RAM CYLINDER

A much needed and sought after part. This power steering ram cylinder is brand new, not rebuilt.

1955-57 #249..... \$169.95/ea.

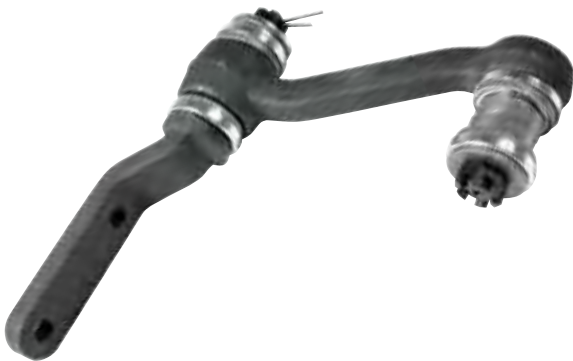

MANUAL STEERING IDLER ARM WITH BEARINGS

Need a new idler arm? Why not get one with an upgraded bearing kit? Mounting bolts not included.

1955-57 #17681 \$149.95/ea.



POWER STEERING IDLER ARM

For use with factory power steering.

1955-57 #12604..... \$65.95/ea.



POWER STEERING RAM CYLINDER FRAME BRACKET

Installs on the frame and the threaded end of the ram cylinder installs through the bracket. Use with part #011 cylinder mounting kit.

1955-57 #13451 \$26.95/ea.



MANUAL STEERING IDLER ARM

See page 423 for corresponding bushing, part #058.

1955-57 #14981 \$59.95/ea.



POWER STEERING RAM CYLINDER BRACKET SHOULDER BOLT TO CENTER LINK

1955-57 #13450..... \$15.95/ea.

POWER STEERING RAM CYLINDER TO BRACKET GROMMETS

These install in the power steering ram cylinder and the cylinder then slides into the bracket on the center link. Use with part #13450 cylinder bracket shoulder bolt.

1955-57 #1855..... \$5.95/pr.





MANUAL STEERING LINKAGE KIT

Kit includes a complete centerlink, pitman arm, idler arm with frame bracket and idler arm bushings. Order #10164 below to complete kit.

1955-57 #15160..... \$179.95/kit



MANUAL STEERING CENTERLINK

This brand new centerlink includes the #057 and #058 but be sure to order part #10164 to complete your installation.

1955-57 #14982..... \$107.95/ea.

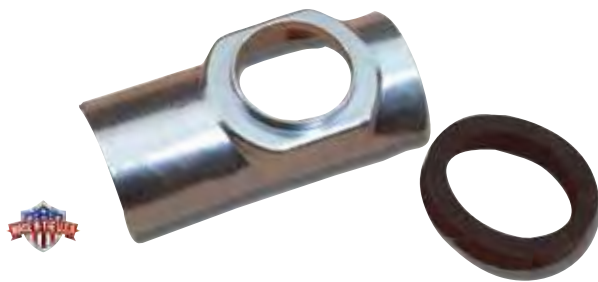

STEERING CONNECTING ROD DUST COVERS WITH GASKET

Located on the drag link where the pitman arm ball connects. Gasket included. **Made in the USA**

1955-57 Standard #10164..... \$10.95/set

1955-57 Power #10164AA... \$10.95/set



STEERING ARMS

1955-57 #15221..... \$74.95/pr.



CENTERLINK REPAIR KIT

Installs in the end of the center link where the ball on the pitman arm connects.

1955-57 exc. Power Steering..... #057..... \$39.95/kit

CENTERLINK ADAPTER, POWER STEERING TO MANUAL STEERING

Allows you to convert your power steering center link to a manual style when you are converting from factory power steering to 500/605 power steering.

1955-57 #10364..... \$81.95/ea.





FRONT ROLLER BEARING CONVERSION KITS

This conversion kit eliminates the old ball bearings and replaces them with modern roller bearings. Though this is an excellent way to modernize stock wheel applications, it's an absolute must-have for those with custom, non-original wheels. Old-style ball bearings can't withstand the side loads that custom width wheels transmit to the bearing. You can use your stock brake drums and will not notice any changes in front end alignment. Kit comes complete with new hubs, studs, inner bearings, outer bearings, races, grease seals, hub caps, and spindle nut washers. Easy to install.

1955-57 Cast Iron	#138.....	\$259.95/kit
1955-64 Forged Aluminum.....	#17986.....	\$189.95/kit



FRONT WHEEL BEARINGS AND OIL SEALS

Outer Bearing:

1955 #001A..... \$89.95/ea.

1956-57 #001..... \$59.95/ea.

Inner Bearing:

1955-57 #002..... \$81.95/ea.

1955-57 Oil Seal, Front Wheel..... #003..... \$15.95/ea.



REAR AXLE BEARINGS

1955-56 #004..... \$107.95/ea.

1957 (Shown) #005..... \$99.95/ea.

FRONT SUSPENSION FASTENER KIT

This complete set of bolts, nuts and washers is the only way to go when reassembling the front suspension. If you're replacing front end parts, don't mount them with tired hardware. Twenty of the bolts are SAE grade eight, the strongest available. Nuts are copper plated to prevent seizing, and all washers are cad plated.

1955-57 #1033..... \$40.95/kit



IDLER ARM WASHER

1955-57 #12700..... \$2.50/ea.





IDLER ARM BEARING KIT

Long time nicknamed the "Poor Man's power steering," these kits include everything needed to bring smoothness and ease to your steering, second only to an expensive power conversion. This kit is by far one of the most inexpensive yet major improvements you will make to your car. Replaces the part #058 and #059 with ball bearings. **Made in the USA.**

1955-57 #2872..... \$139.95/kit

IDLER ARM SUPPORT BUSHING

Excess play in your steering could be caused by this bushing. One per car required. Use with part #058 for a complete solution.



1955-57 #059..... \$15.95/ea.

IDLER ARM BUSHING

Excess play in your steering could be caused by this bushing. One per car required. Use with part #059 for a complete solution.



1955-57 #058..... \$15.95/ea.

TIE ROD END URETHANE BOOTS

Previously unavailable in any form, these urethane boots have become a necessity for every car. Keep your tie rod ends free of dust and dirt with this state-of-the-art, long lasting boot. These easily installed boots fit both inner and outer tie rod ends. Two pair per car required.



1955-57 #1444..... \$9.95/pr.



MOOG BALL JOINTS

The choice of professional technicians for decades Moog front end parts set the bar for quality. These ball joints feature their powdered metal gusher design which allows grease to flow through from bearing to stud allowing new lubricant to flush out contaminants resulting in reduced friction and enhanced strength. **Made in the USA.**

1955-57 Lower..... #051A \$77.95/ea.
1955-57 Upper..... #050A \$59.95/ea.

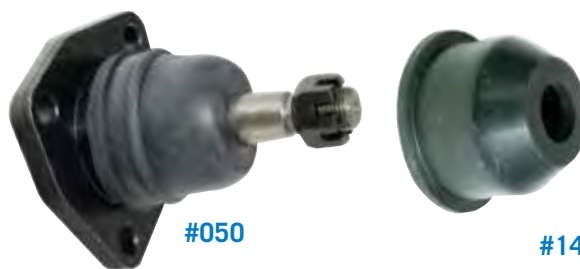

UPPER BALL JOINTS

Two are needed per car.

1955-57 Better..... #050..... \$29.95/ea.
1955-57 Good..... #16690..... \$21.95/ea.

UPPER BALL JOINT BOOT

1955-57 #14933..... \$4.95/ea.



LOWER BALL JOINTS

Two are needed per car.

1955-57 Better..... #051 \$48.95/ea.
1955-57 Good..... #16752..... \$36.95/ea.

REPLACEMENT URETHANE BALL JOINT BOOT

These urethane replacement ball joint boots work great at replacing damage or missing rubber ball joint boots and are much more durable. They are a slip on design that do not require a retainer.

1955-57 Upper/Lower..... #18215..... \$3.95/ea.

COMPLETE STEERING AND FRONT END REBUILD KITS

Whether you are doing a stock rebuild or an upgrade to polyurethane bushings, this kit has almost everything you need to freshen up the front end of your classic. Urethane kits do not include idler arm bushings, so be sure to order # 2872 to complete the job.



1955-57 w/ Urethane Bushings	#12274.....	\$379.95/kit
1955-57 w/ Rubber Bushings	#15158.....	\$389.95/kit

#055A



#054A

MOOG TIE ROD ENDS

Moog front end parts have been the "go to" for quality by professional technicians since the 1930's. Moog's "Problem Solver" parts improve on the design of factory units to assure longer life and the best in performance. These tie rods feature their powdered metal gusher design which allow grease to flow through from bearing to stud for reduced friction and enhanced strength. Note: Inner tie rods on factory power steering cars used a longer tie rod and a shorter tie rod sleeve. Danchuk #055A can be used on factory power steering cars as long as you replace the shorter sleeve with Danchuk #056. Made in the USA.

1955-57 Outer.....	#054A.....	\$49.95/ea.
1955-57 Inner.....	#055A.....	\$59.95/ea.

#055



#054

TIE ROD ENDS

Two inner and two outer tie rod ends required per car. Factory power steering cars used a longer inner tie rod and a shorter sleeve, so be sure to order the correct inner tie rod #13560. Part #055 can also be used on power steering but requires the replacement of the original adjusting sleeve with part #056, shown below.

1955-57 Best, Outer	#054.....	\$33.95/ea.
1955-57 Good, Outer	#16753.....	\$27.95/ea.
1955-57 Best, Inner	#055.....	\$35.95/ea.
1955-57 Good, Inner	#16754.....	\$27.95/ea.
1955-57 Inner, Driver, Factory Power Steering Only	#13560.....	\$79.95/ea.



BILLET ALUMINUM TIE ROD ADJUSTMENT SLEEVES

1955-57 Black.....	#15273.....	\$79.95/ea.
1955-57 Polished.....	#15274.....	\$79.95/ea.



TIE ROD ADJUSTMENT SLEEVE

Two are needed per car.

1955-57	#056.....	\$25.95/ea.
---------------	-----------	-------------



TIE ROD ADJUSTMENT SLEEVE FOR FACTORY POWER STEERING

1955-57 Driver.....	#13564.....	\$16.95/ea.
---------------------	-------------	-------------



CLASSIC PERFORMANCE COMPLETE SUSPENSION PACKAGE O/S

Get a complete performance package and tune up your chassis with some of the best upgrades for a great price! This package teams up all of the pieces that will convert your ride into a corner carver on the track and a pleasure to drive on the streets. Totally tubular control arms, dropped spindles, front coil springs, front and rear performance sway bars and front and rear Black Magic performance tuned shocks, as well as rear leaf springs. All topped off with a CPP 500 series power steering conversion box.

1955-57 #17980..... **\$2029.95/kit**

COMPLETE FRONT SUSPENSION REBUILD KITS

Get everything you need to completely rebuild your front suspension on your Classic Chevy. The kit includes: assembled upper and lower control arms with ball joints, rubber bushings, and cross shafts, stock height spindles, steering arms, shocks, inner and outer tie rod ends, tie rod adjustment sleeves, idler arm, manual steering pitman arm, manual steering centerlink and coil springs. This kit is great for those who need everything that are doing a stock restoration and don't have access to a press or shop to perform the required work.



1955-57 Stock Spring #18364..... **\$1099.95/kit**

1955-57 1-1/2" Drop Spring..... #18770..... **\$1099.95/kit**

A-ARMS Suspension

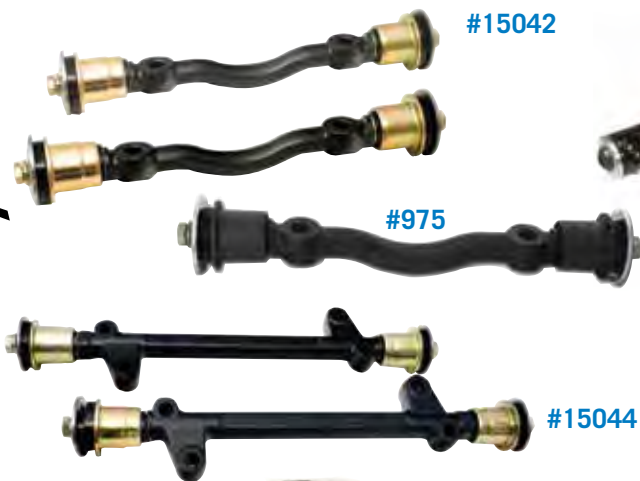

CPP TUBULAR A-ARMS

Tubular control arms provide full suspension travel with minimum friction and come assembled with chrome-moly cross shafts and bushings. The upper arm adds five degrees of positive caster, for better handling and return to center, while the lowers provide increased ground clearance and have sway bar mounting points. They use factory ball joints (sold separately) and can be installed with either factory upper or lowers or as a full set. The bushings are made from a self lubricating non-squeak compound that will outlast any rubber or urethane.

1955-57 Upper.....	#10208.....	\$290.95/pr.
1955-57 Lower.....	#10209.....	\$430.95/pr.
1955-57 Upper, w/ Ball Joints	#15458.....	\$359.95/pr.
1955-57 Lower, w/ Ball Joints (Shown)	#15459.....	\$479.95/pr.

A-ARM SHAFT KITS

Upper shafts have extra 2° of caster built into them and are a must for power steering conversions. Kits come with shafts, bushings and hardware. On lower shaft, longer bolts may be necessary to install shaft.

1955-57 Upper, Offset w/ Rubber Bushings (Shown)	#975.....	\$119.95/pr.
1955-57 Upper, Offset, w/ Poly Bushings (Shown)	#15042.....	\$99.95/kit
1955-57 Lower, w/ Rubber Bushings	#15043.....	\$83.95/kit
1955-57 Lower, w/ Poly Bushings (Shown)	#15044.....	\$99.95/kit
1955-57 Upper & Lower, w/ Rubber Bushings	#15045.....	\$179.95/kit
1955-57 Upper & Lower, w/ Poly Bushings	#15046.....	\$189.95/kit



A-ARM DUST SHIELDS

These shields are made exactly like Chevy's first design. Their primary job is to keep dirt out of the engine compartment, but engine heat and the elements are their chief enemy. Don't forget these important parts when restoring the engine compartment. Finish the job with new dust shield retainers (#2053 & 2054).

Made in the USA.

1955-56 (Shown)	#546.....	\$13.95/pr.
1957.....	#547.....	\$14.95/pr.



POLISHED ALUMINUM A-ARM BUSHING CAPS

Set of 8.

1955-57	#15475.....	\$254.95/set
---------------	-------------	--------------



A-ARM UPPER AND LOWER RETAINER NUTS

1955-57	#972.....	\$16.95/set
---------------	-----------	-------------



BLACK URETHANE UPPER AND LOWER A-ARM BUSHINGS

1955-57	#978.....	\$81.95/set
---------------	-----------	-------------



GLOBAL WEST G-PLUS TUBULAR A-ARMS



Global West tubular control arms are designed to change suspension geometry for improved straight line stability and handling. Powder coated black, the upper and lower arms feature a billet cross shaft with Del-a-lum bushings, bump stops, replaceable ball joints, installation hardware and complete instructions. Lower arms also feature attachment points for sway bars and an adjustable steering stop which allows you to adjust the turning radius to compensate for the variances between different spindles on the market. For regular coil spring applications use #13852 and 13854. For coil over spring applications use #13852 and the #18381 extended travel lower arms which have been designed to lessen the chance of bottoming out when the suspension is adjusted fairly low. All Global West tubular arms will replace your original a-arms with no modifications. **Made in the USA.**

1955-57 Upper.....	#13852.....	\$672.95/pr.
1955-57 Lower, for Coil Springs.....	#13854.....	\$899.95/pr.
1955-57 Lower, for Coil over Shocks.....	#13856.....	\$798.95/pr.
1955-57 Lower, for Coil over Shocks Extended Travel	#18381.....	\$839.95/pr.

GLOBAL WEST LOWER BEARING SHOCK MOUNT KITS

These lower bearing kits are necessary when installing either Viking or QA-1 shocks into your Global West A-Arms, part #18381. See page 437 for photo.

All Viking	#19288.....	\$79.95/kit
All QA-1	#19288.....	\$79.95/kit

STAINLESS A-ARM DUST SHIELD STAPLES



Make your restoration complete by mounting your A-arm dust shields to the inner fenders with these authentic stainless steel staples. **Made in the USA.**

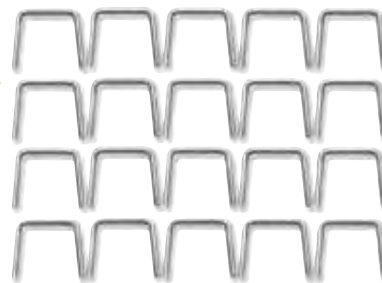

1955-56	#2181.....	\$4.95/set
---------------	------------	------------

#2054



A-ARM DUST SHIELD RETAINERS



Part #2053 was also used on late 1955 models. Check your car before ordering.

1956 w/ Staples	#2053.....	\$12.95/set
1957 w/ Fasteners	#2054.....	\$19.95/set

A-ARM CUSHIONS

Two lower and two upper cushions are needed per car. The lower A-arm cushion has a sturdy mounting bolt molded into the rubber cushion.



1955-57 Upper.....	#037.....	\$8.95/ea.
1955-57 Best, Lower	#038.....	\$14.95/ea.
1955-57 Good, Lower	#16791.....	\$9.95/ea.

A-ARM BUSHINGS

Four lower and four upper bushings are needed per car.

1955-64 Upper..	#052.....	\$11.95/ea.
1955-64 Lower..	#053.....	\$8.95/ea.



A-ARM SHAFT WASHERS

1955-57 Upper.....	#12709.....	\$1.95/ea.
1955-57 Lower.....	#12710.....	\$2.25/ea.





HEIDT'S TUBULAR STAINLESS A-ARMS

Heidt's A-arms are the ultimate in looks and are a direct replacement for the factory A-arms. The upper arms have off-set cross shafts for increased camber adjustment and are built with six degrees of caster. The lower arms are a perfect match to the upper arms and feature the correct style ball joints, steering stops and sway bar tabs welded in place. **Ball joint caps sold separately.**

- 1955-57 Polished Stainless, Upper, 6° Caster #14194.....\$989.95/pr.
- 1955-57 Polished Stainless, Lower #14195.....\$1795.95/pr.
- 1955-57 Plain Finish, Upper, 6° ... #15279.....\$549.95/pr.
- 1955-57 Plain Finish, Lower #15280.....\$932.95/pr.



SINGLE ADJUSTMENT TRACTION BARS

This is a highly functional traction device and alternative to "slapper bars" or ladder bars. Right and left-hand threaded rod ends allow for easy adjustment and pre-loading of suspension. Tig welded throughout with bolt-on rear brackets at spring mounts and weld on front brackets.

- 1955-57 Spring Pocket Kit, Bare.. #12190.....\$392.95/pr.
- 1955-57 Spring Pocket Kit, Chrome #12191.....\$549.95/pr.
- 1955-57 Spring Pocket Kit, Powder Coated #12192.....\$409.95/pr.
- 1955-57 Stock Location, Bare..... #12193.....\$349.95/pr.
- 1955-57 Stock Location, Chrome . #12194.....\$429.95/pr.
- 1955-57 Stock Location, Powder Coated #12195.....\$399.95/pr.



BALL JOINT CAPS

For Heidt's A-arms only.

- 1955-57 Polished, Stainless #15474.....\$124.95/pr.



OE STYLE A-ARMS

These brand new, beautifully stamped, OE replacement control arms come complete and fully assembled with ball joints, cross shafts and bushings. These are available in stock design or in a modified design which has +5 degrees of caster built in for better handling. Both designs are available with rubber or PolyPlus bushings.

- 1955-57 Upper, w/ Rubber Bushings #18123.....\$229.95/pr.
- 1955-57 Upper, w/ Poly Bushings. #18124.....\$242.95/pr.
- 1955-57 Upper, w/ Rubber Bushings, +5 Degree Caster #17913.....\$229.95/pr.
- 1955-57 Upper, w/ Poly Bushings, +5 Degree Caster #18125.....\$249.95/pr.
- 1955-57 Lower, w/ Rubber Bushings #18126.....\$299.95/pr.
- 1955-57 Lower, w/ Poly Bushings. #18127.....\$339.95/pr.



CLASSIC PERFORMANCE TUBULAR TRACTION BARS

CPP's Traction Bars are constructed from 1-inch 0.156-wall 4130 with 3/16-inch laser-cut, bent-steel mounts, self-lubricating plastic D-type bushings and 3/4-inch rod ends. The front mount features additional ground clearance and a forward-slanted approach angle; this makes it safer, if in the event it does hit something, the angled approach will act as a skid plate and help lift the car over the obstacle. The portion of the linkage that contacts the spring is a wider flat surface; this reduces the stress on the top of the leaf spring. The pivot positions are relocated to optimize weight transfer while reducing the spring load.

- 1955-57 Black #18682.....\$299.95/pr.



FORD 9-INCH POSI-REAR ENDS

John's Industries rear ends feature all brand new components which include a powder coated heavy duty notch back housing with big bearing style billet flanges, 31 spline axles, Powertrax carrier, John's Nodular iron case with an aluminum pinion support, forged pinion yolk and pre-bent stainless brake lines. All 9" rear ends come with plain rotors and black calipers, upgraded rotors and calipers are available for an additional charge. Different axle ratios are available by request. #18405 and #18406 are bolt-in assemblies that replace your existing rear end. #18407 and #18408 require the use of our leaf spring relocation kit, #10235 and relocation shock mount, #11290 which relocate the springs in line with the frame rails for additional clearance. Special order only, these units are shipped fully assembled and crated via truck freight. Shipping charges are usually between \$300.00 and \$375.00 to the 48 contiguous states depending on delivery location. **Picture shown with upgrades, u-bolts and plates, bumpers and retainers, upgraded rotors and calipers not included but available for additional cost. Made in the USA.**

1955-57 w/ 3.50 Ratio, Disc Brakes, Stock Width.....	#18405.....	\$3999.95/ea.
1955-57 w/ 3.70 Ratio, Disc Brakes, Narrowed 1.5".....	#18406.....	\$3999.95/ea.
1955-57 w/ 3.70 Ratio, Disc Brakes, Narrowed 3", Leaf Spring Relocation Required		
.....	#18407.....	\$3999.95/ea.
1955-57 w/ 3.70 Ratio, Disc Brakes, Narrowed 7", Leaf Spring Relocation Kit Required		
.....	#18408.....	\$3999.95/ea.



TRACTION BARS

These traction bars will help to eliminate wheel hop. These install by replacing the lower spring plate at the rear and the front bolts to the front bolt on your leaf springs. No welding necessary!

1955-57	#2753.....	\$194.95/pr.
---------------	------------	--------------

BOLT-IN, SINGLE ADJUSTMENT TRACTION BARS

Highly functional traction device and alternative to "slapper bars" or ladder bars. Great looking 1-1/4" O.D. 4130 chrome moly bars with 3/4" stainless steel urethane bushed rod ends. Right and left hand threaded rod ends allow for easy adjustment and pre-loading of suspension. Tig welded throughout with bolt-on rear brackets at spring mounts; bolt on front brackets. Grade 8 hardware included.

1955-56 Bare.....	#15901.....	\$424.95/pr.
1957 Bare.....	#15902.....	\$424.95/pr.
1955-56 Powder Coated	#15903.....	\$459.95/pr.
1957 Powder Coated	#15904.....	\$459.95/pr.

REAR END SNUBBER BRACKET

Rubber bumper included, this bracket welds to the underside of the floor right above the differential.

1955-57 w/ Rubber.....	#16101.....	\$28.95/ea.
------------------------	-------------	-------------





REAR 4-LINK SUSPENSION KIT

The triangulated suspension design of the CPP 4-link keeps the axle on center without the need for a panhard or trac bar. It's design provides you plenty of room to route your exhaust and the 9-inch of travel assures smooth ride quality. The kit is designed for maximum ground clearance and no modifications are needed in the floor board when installing the brackets and links. Rear end and high clearance sway bar not included. Use with the CPP Pro-Touring or high clearance sway bars.

1955-57 #19440..... \$995.95/kit

REAR END CONVERSION KIT

With this kit you have everything you need to install any rear end with 3-inch axle tubes into your classic. Kit includes lower shock plates, u-bolts, bolt in rear shock mount with frame brackets and hardware and spring perches. Welding required.

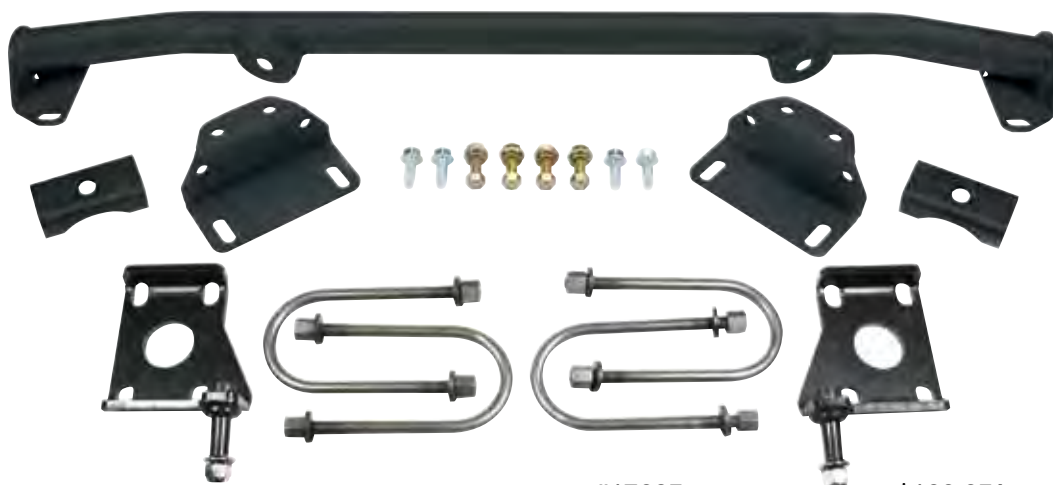

1955-57 #17985..... \$189.95/ea.



REAR SPRING RELOCATION POCKET KIT

Moving the springs from outside the frame to underneath the frame allows you to run 10-inch wide wheels without having to narrow the frame or rear-end. Use part #11290 for proper shock alignment. For even bigger tires install with our mini tub kit part #12183. Welding required. See page 433 for leaf spring relocation rear shock mount part #11290. For use with #15245 sway bar.

1955-57 #10235..... \$269.95/kit



REAR SPRING SHACKLE KITS

The 1955 design worked for both passenger and driver sides, so when ordering be sure to order two. In 1956 and 1957 there were two different parts, one for each side.

- 1955..... #062..... \$32.95/ea.
- 1956-57 Passenger..... #060..... \$34.95/ea.
- 1956-57 Driver (Shown)..... #061..... \$34.95/ea.

URETHANE SPRING SHACKLE BUSHING SETS



Urethane is a far superior material to rubber in heavy duty applications. You may never have to replace your shackle bushings again! Each kit contains a set of eight bushings for both upper and lower ends of the shackle. **Made in the USA.**

- 1955..... #1078..... \$39.95/set
- 1956-57..... #1079..... \$39.95/set

SPRING SHACKLE BUSHINGS

Rear spring shackle bushings are sold separately. 1955 models use eight #064 bushings per car. 1956 and 1957 models use four upper bushings (#063) and four lower bushings (#064) per car.



- 1955 All, 1956-57 Lower..... #064..... \$4.95/ea.
- 1956-57 Upper..... #063..... \$4.95/ea.

REAR AXLE BUMPER RETAINERS

Exactly like the originals. Use with part #862.



- 1955-57..... #2255..... \$21.95/pr.

#861



#862



REAR AXLE RUBBER BUMPERS

The rear axles' up and down travel is limited by these rubber bumpers. Part #861 installs into the bracket above the third member that is welded to the floor. Part #862 is held in place with part #2255 on top of the axle tube.

- 1955-57 Best, Upper..... #861..... \$12.95/ea.
- 1955-57 Best, Lower..... #862..... \$12.95/pr.
- 1955-57 Good, Lower..... #16792..... \$6.95/ea.



REAR AXLE BEARINGS

- 1955-56..... #004...\$107.95/ea.
- 1957 (Shown)..... #005.....\$99.95/ea.



REAR AXLE REAR BEARING RETAINER

- 1957.... #19011.\$32.95/ea.



REAR AXLE LEAF SPRING PERCHES

Welding required, for 3-inch housing.

- 1955-57..... #11289..\$19.95/pr.



REAR DIFFERENTIAL PINION SEAL

- 1955-57..... #16219.\$19.95/ea.



REAR AXLE VENT

- 1955-57..... #18321.\$13.95/ea.



REAR AXLE BEARING RETAINER HARDWARE

- 1955-57..... #19012...\$8.95/set



ORIGINAL STYLE REAR END DRAIN PLUG

Over time these get damaged and destroyed. Replace that beat up original with this quality reproduction.

- 1957.... #16979...\$1.75/ea.



AXLE FLANGE SEAL

- Two seals needed per car.
- 1955-64..... #1906.....\$2.50/ea.

HI-PERFORMANCE DIFFERENTIAL



Auburn limited slip differentials offer you more torque bias performance than any other limited slip available, thus giving you more torque to be delivered to the wheel with the most traction and putting more horsepower to the ground. Auburn also backs up their differentials with a 1-year warranty PLUS an additional 4-years of D-REX coverage which replaces your differential with a new unit, no matter the reason, within the first 4-years after purchase for the small price of a competitors clutch pack. **Made in the USA.**



1955-57 10-Bolt, 17 Spline, Limited Slip, Pro Series
 #13796..... \$524.95/ea.



COPPER DIFFERENTIAL CARRIER WASHERS AND NUTS

The copper washers help to keep the rear end fluid from seeping over the bolts in the axle housing.

1955-64 #1547 \$17.95/set



STAINLESS REAR END COVER BOLTS WITH 12-POINT HEAD

All 10-Bolts #14034 \$31.95/set
 All 12-Bolts #14035 \$31.95/set



STAINLESS REAR END COVER BOLT KITS WITH BOWTIE

All 10-Bolt #14282 \$17.95/kit
 All 12-Bolt #14283 \$21.95/kit



PERFECT LAUNCH ALUMINUM REAR END COVERS

These reinforced 8.2/8.5 10 bolt and 12 bolt aluminum rear end covers are designed to strengthen the rear housing case in heavy torque situations. The PERFECT LAUNCH™ logo is prominently displayed on a precision milled surface. Each cover includes two bolts to stabilize the bearing main caps, fluid capacity and magnetic drain plugs and mounting bolts. Covers have a black painted finish.

All 8.2/8.5, 10-Bolt #16914 \$153.95/ea.
 All 8.2/8.5, 12-Bolt #16915 \$153.95/ea.



REAR END CENTER SECTION TO HOUSING GASKET

1955-64 #10317 \$8.95/ea.



LEAF SPRINGS O/S

These springs are made from all new steel, not re-arched and rebuilt like others. Our five-leaf spring is a heavy duty version for all passenger cars. Each spring includes the front bushing, pre-pressed into the spring for an easier installation. Springs are painted black. For bolts, see #11294 shown below. Now available in reversed eye 2 and 3-inch lowered applications. Lower your car the right way with our 5-leaf reversed eye lowered leaf springs. Built to the same standards as our #285, they include the front bushing pre-installed.

1955-57 5-Leaf, Stock Height	#285	\$255.95/pr.
1955-57 5-Leaf, 2" Drop	#15970	\$246.95/pr.
1955-57 5-Leaf, 3" Drop	#15971	\$239.95/pr.



LEAF SPRINGS REAR LOWERING BLOCKS

1955-57 2"	#2704	\$51.95/pr.
1955-57 3"	#2705	\$52.95/pr.



LEAF SPRING PLATES WITH LOWER SHOCK MOUNT STUDS

1955-57	#1904	\$99.95/pr.
----------------------	--------------------	--------------------



LEAF SPRING RELOCATION REAR SHOCK MOUNT

Use with part #10235. Allows for proper rear shock installation when moving your leaf springs.

1955-57 exc. Nomad & Wagon	#11290	\$45.95/kit
--	---------------------	--------------------



LEAF SPRING FRONT BUSHING AND BOLT KIT

One kit necessary per leaf spring; two kits per car.

1955-57	#065	\$27.95/kit
1955-57 Bolt w/o Bushing, Front, One Side	#11294	\$2.50/ea.

Suspension

LEAF SPRING INSERT LINERS

No more squeaky springs. Our leaf spring insert liners are made of nylon, and when installed between each individual leaf give you a quiet ride. Made just like the originals.



- 1955-57 4-Leaf #240 \$21.95/kit
- 1955-57 5-Leaf #241 \$21.95/kit
- 1955-57 6-Leaf #242 \$23.95/kit

SPRINGS

LEAF SPRING U-BOLT AND NUTS

Four needed per car.

- 1955-57 #069 \$16.95/ea.



#194

SHOCK MOUNTING RUBBER AND HARDWARE KITS

Includes all rubber bushings and hardware.

- 1955-57 Front #194 \$17.95/kit
- 1955-57 Rear #196 \$34.95/kit



SHOCK MOUNTING STUDS

- All Lower, Rear #14983 \$19.95/pr.



FRONT DUAL RATE COIL SPRINGS

Dual-rate springs allow the vehicle to transition small road irregularities via a soft spring rate. When the vehicle compresses the spring far enough (through large bumps or cornering), it transitions to the firmer spring rate to control the bump or body roll. Dual rate springs assure your classic will have the best ride possible under all driving conditions.

- 1955-57 SB #18439 \$224.95/pr.
- 1955-57 BB #18440 \$224.95/pr.



COIL SPRINGS

- 1955-57 Stock Replacement #068A \$107.95/pr.
- 1955-57 SB, 1-1/2" Lowered #10236 \$99.95/pr.
- 1955-57 BB, 1-1/2" Lowered #15159 \$99.95/pr.



TUBULAR SHOCK CROSS MEMBER

Newly designed to fit all body styles and frames. Complete bolt-in installation comes powder coated and includes hardware.

1955-57 All Frames/Body Styles exc. Wagons..... #17760..... \$124.95/ea.



SHOCK CROSS MEMBERS

1955-57 Weld-in, Nomad & Wagon #12187..... \$129.95/ea.
 1955-57 Weld-in, exc. Nomad & Wagon..... #12188..... \$129.95/ea.
 1955-57 Built-in, exc. Nomad & Wagon..... #950..... \$46.95/ea.



BILSTEIN GAS SHOCK ABSORBERS

Bilstein's shock bodies are precision formed through a unique seamless extrusion process. This provides superior strength and high tolerances that are usually associated with surgical instruments. The shock body is then treated with a special paint finish durable enough to withstand a grueling 240-hour salt spray test. The finished body is mated with a solid, induction hardened steel chrome plated and polished shaft, machined valving components and highest quality seals. Mounting hardware included.

1955-57 Front..... #12030..... \$117.95/ea.
 1955-57 Rear..... #12031..... \$117.95/ea.



MONROE OESPECTRUM SHOCK ABSORBERS

Monroe uses a low pressure nitrogen gas in these shocks to virtually eliminate shock fade. That means that they provide a quicker, more consistent response to road irregularities and increased roll stability without increasing ride harshness. Monroe gas shocks are ideal for use with radial or bias-ply tires. For even better handling, see our front and rear anti-sway bars, shown on pages 438-439. Mounting hardware included.

1955-57 Front..... #186..... \$39.95/ea.
 1955-57 Rear..... #187..... \$45.95/ea.



QA1 PROMA-STAR COIL OVER SHOCK CONVERSIONS

QA1 Proma-Star coil over conversion shocks feature a threaded aluminum body and a single adjustment knob that gives you 18 valving options. Allows for up to a 3-inch lowering of the car. Use #13396 for height adjustments. Use with part #14533 rear shocks to complete the package.



1955-57 SB, 350-lbs. Springs	#13398.....	\$589.95/pr.
1955-57 BB, 450-lbs. Springs	#13399.....	\$589.95/pr.
1955-57 BB, 550-lbs. Springs	#15161.....	\$599.95/pr.

SHOCKS



QA1 STOCKER STAR REAR SHOCK ABSORBERS

These shocks are a perfect match for those running Proma-Star coil over shocks up front. Single adjust shocks have 18 settings that control rebound/compression.

1955-57 Single Adjustable, Aluminum Body	#14533.....	\$207.95/ea.
--	-------------	--------------



QA1 STOCKER STAR ALUMINUM SHOCK ABSORBERS

Built with the same quality as the adjustable Stocker Stars, these non-adjustable shocks were designed for the builder on a budget.

1955-57 Front, Non-Adjustable	#17376.....	\$144.95/ea.
1955-57 Rear, Non-Adjustable	#17377.....	\$144.95/ea.



QA1 PROMA COIL OVER SPANNER WRENCH AND THRUSTBEARING

All.....	#13396.....	\$59.95/set
----------	-------------	-------------



BLACK URETHANE ANTI-SWAY BAR LINK KIT

1955-57	#980.....	\$21.95/kit
---------------	-----------	-------------



ANTI-SWAY BAR MOUNTING BUSHINGS

These urethane bushings provide superior handling and last far longer than their original rubber predecessors. Brackets have a gold-tone finish.

1955-57 Front or Rear, 7/8"	#1349.....	\$19.95/kit
--	------------	-------------



ANTI-SWAY BAR LINK KIT

Though this kit is included with our front and rear sway bars, they do wear out and must be periodically checked and replaced. Two link kits are necessary per sway bar, included with our sway bar kits.

1940-57	#067.....	\$12.95/kit
----------------------	-----------	-------------



VIKING COIL OVER TOTAL VEHICLE KITS

Billet aluminum bodied double adjustable shocks for the front and rear of your classic Chevy. Front coil overs include high travel powder coated springs, thrust bearings and spanner wrenches for total ride height adjustment. Rear shocks are smooth bodies for a clean look. Shocks are clear anodized for long lasting looks and ease of cleaning. Includes mounting hardware.



Suspension

SHOCKS

1955-57 350-lbs. Springs.....	#17616.....	\$960.00/kit
1955-57 450-lbs. Springs.....	#17617.....	\$970.00/kit
1955-57 550-lbs. Springs.....	#17618.....	\$970.00/kit
1955-57 650-lbs. Springs.....	#17619.....	\$990.00/kit



VIKING DOUBLE ADJUSTABLE SHOCK ABSORBERS

Billet aluminum bodied double adjustable shocks for the front or rear of your classic. Perfect for those looking for the ultimate in suspension and ride adjustment at an affordable price. Clear anodized for a long lasting look and ease of cleaning. Includes mounting hardware. **Made in USA.**

1955-57 Front.....	#17624.....	\$195.00/ea.
1955-57 Rear (Shown)	#17625.....	\$190.00/ea.

VIKING DOUBLE ADJUSTABLE COIL OVER KITS - FRONT ONLY

1955-57 350-lbs. Springs.....	#17620.....	\$580.00/kit
1955-57 450-lbs. Springs.....	#17621.....	\$590.00/kit
1955-57 550-lbs. Springs.....	#17622.....	\$590.00/kit
1955-57 650-lbs. Springs.....	#17623.....	\$610.00/kit



LOWER BEARING SHOCK MOUNT KITS

These lower bearing kits are necessary when installing either Viking or QA-1 shocks into your Global West A-Arms, part # 18381.

All Viking	#19288.....	\$79.95/kit
All QA-1	#19288.....	\$79.95/kit



RIDETECH HQ SERIES SHOCKS

1955-57 Front, Single-Adjustable	#17554.....	\$184.95/ea.
1955-57 Rear, Single-Adjustable..	#17555.....	\$184.95/ea.

END LINK BUSHINGS

The urethane composition of these bushings makes them longer lasting and better handling than any rubber version.



1955-57	#1348.....	\$12.95/kit
---------------	------------	-------------



CPP HIGH CLEARANCE SWAY BAR KITS O/S

CPP has designed these sway bars to give you additional clearance where you need it most. The front bar features a laser cut 3/8-inch leg that fits tight against the chassis allowing for a much larger front tire. Rod ends eliminate the fixed position end link bushings for more clearance and the fully adjustable heim joint end link setup allows for multiple mounting positions and preload adjustments. The rear bar features billet ends welded to the center of the bar allowing for more clearance around the shock mounts giving you the benefits of a pro-touring sway bar in less space. Fits all rear ends with a 3-inch axle tube. Hardware included with both kits.

1955-57 Front.....	#19406.....	\$199.95/kit
1955-57 Rear.....	#19407.....	\$199.95/kit

Hope to see you at the Danchuk Tri-Five Nationals!





#17981

CPP FRONT SWAY BAR O/S

These bars feature a cleaner looking mounting points, powdercoated mounting brackets, greasable poly "D" bushings, poly endlinks and all mounting hardware. Frame bushings include billet aluminum mounting brackets for a clean custom look.

1955-57 1", Billet Hardware (Shown) #17981..... \$179.95/ea.



#17983

CPP PRO-TOURING STYLE REAR SWAY BARS O/S

CPP Pro Touring rear sway bar feature a 3 position adjustment on each side of the bar. This allows full adjustability from soft to firm settings in minutes by simply moving the end link to a different setting. Perfect for both street and track cars. These bars have cleaner looking mounting points, powdercoated mounting brackets, greasable poly "D" bushings, Heim style endlinks and all mounting hardware. Rear end bracket clamps securely on the rear end housing creating a super strong mounting point. Kits are available with standard or billet aluminum mounting brackets. Will work with both stock leaf springs and pocket kits.

1955-57 Stock Hardware..... #17982..... \$229.95/ea.
1955-57 Billet Hardware (Shown) #17983..... \$279.95/ea.





#14654

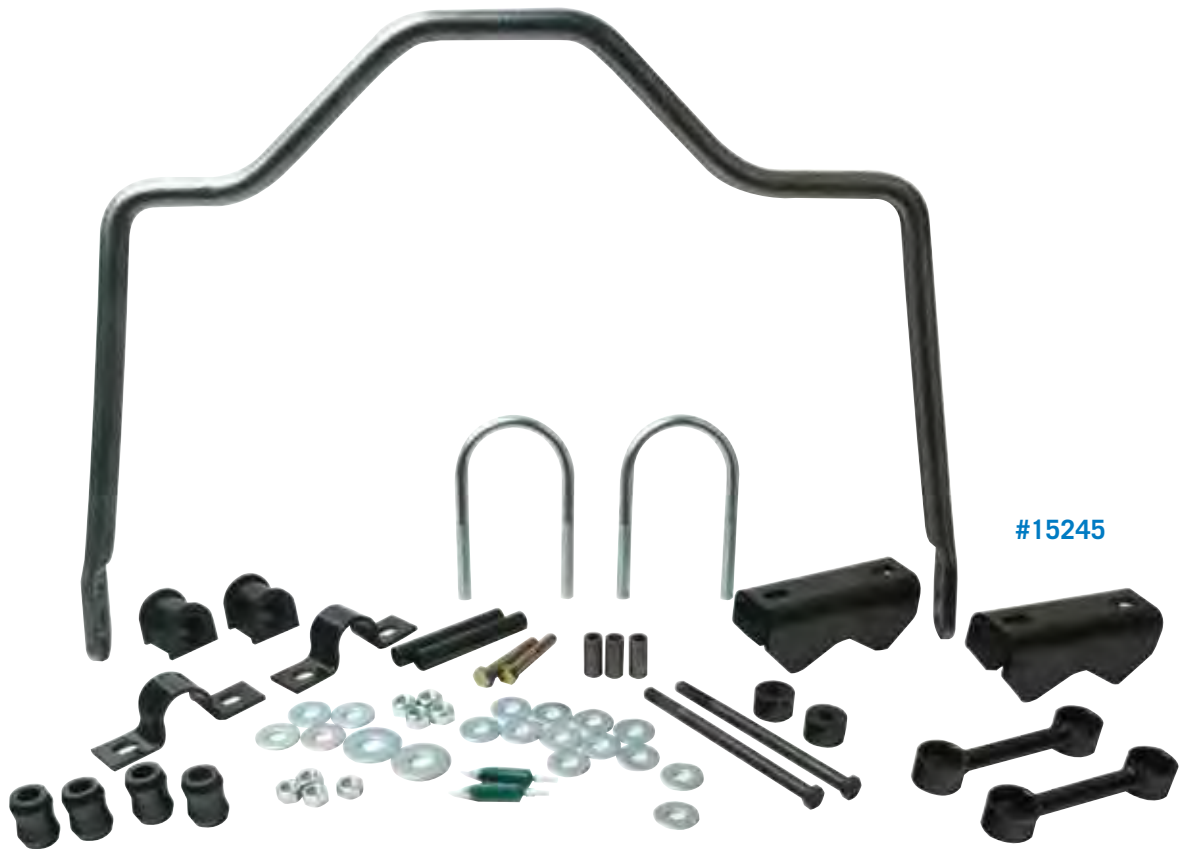

#15245

HELLWIG SWAY BARS WITH SILVER VEIN FINISH O/S

Hellwig sway bars are made from hot-formed 4140 chrome-moly, which makes them 50% stronger than cold-formed bars. The Silver Vein powder coated finish gives you an extremely durable finish which helps retain bushing lube for squeak free operation. Kits come with mounting hardware, urethane bushings, black powdercoated brackets and complete instructions. The rear sway bar is 3-position adjustable, which helps you fine-tune your suspension, and it will work with all body styles, including wagons. Use part #15245 for cars using rear spring relocation kits.

1955-57 7/8", Front	#897.....	\$162.95/kit
1955-57 1-1/4", Front	#14654.....	\$274.95/kit
1955-57 1", Rear Adjustable	#14901.....	\$314.95/kit
1955-57 1", Rear Adjustable w/ Rear Pocket Spring Location.....	#15245.....	\$274.95/ea.

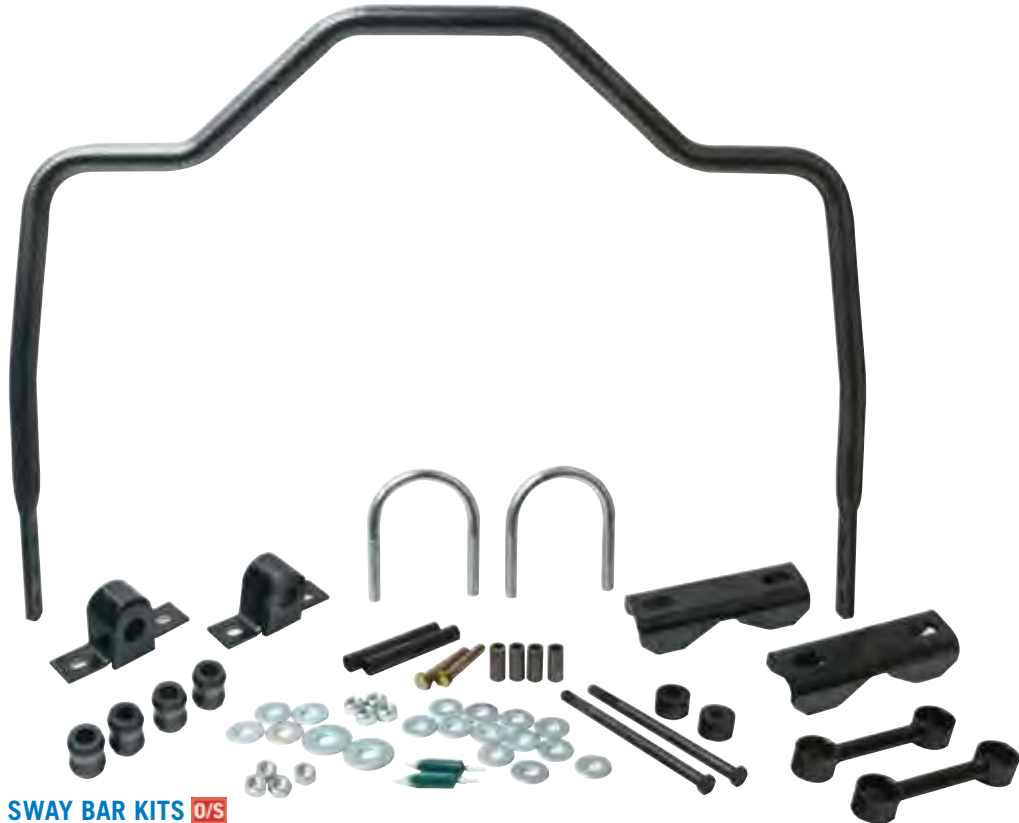

HELLWIG TUBULAR SWAY BAR KITS O/S

Tubular sway bars are the latest in sway bar development and feature reduced weight, nearly half that of a traditional bar. Reduced weight helps your car to handle better while still giving you the performance of a big sway bar. The “Special Black” edition sway bar kits are available only through Danchuk and feature a tubular 1-1/4” front bar and an adjustable 1inch tubular rear bar along with hardware and urethane bushings. Part #15914 kit is designed for cars that have had the rear leaf spring pocket kit installed. Kits come with urethane bushings, mounting hardware, black powder coated brackets and complete instructions.

1955-57 Front, Silver Vein, 1-3/8”	#15555	\$303.95/ea.
1955-57 Rear 3-Position Adjustable, Silver Vein, 1”	#16340	\$274.95/ea.
1955-57 Front & Adjustable Rear, w/ Stock Spring Location, “Special Black”	#15913	\$449.95/kit
1955-57 Front & Adjustable Rear, w/ Rear Pocket Spring Location “ Special Black”	#15914	\$449.95/kit

HOTCHKIS
TUBULAR ANTI-SWAY BARS O/S

Hotchkis sway bars are tubular to reduce weight. The 2-position adjustable rear bar allows for fine tuning. Kits include TIG welded end-links with easy to lubricate polyurethane bushings, premium mounting hardware including, stainless steel u-bolts, laser cut axle mounts (rear), polyurethane bushings, grade 8 bolts and gloss black powder coat finish. Kits are available in front/rear sets or sold individually.



1955-57 1 3/8” Front	#15224	\$359.95/ea.
1955-57 1” Rear Adjustable	#15225	\$428.95/ea.
1955-57 1 3/8” Front & 1” Rear Adjustable	#15223	\$737.95/set

COIL-OVER SUSPENSION



COMPLETE PACKAGE

FRONT & REAR COIL-OVER SUSPENSION SYSTEMS

There seems to be more 55-57 Chevys on the road today than in 1957! Their tall, boxy shape may say "low and slow", but in reality they can be a crisp performer with the right suspension enhancements.

All of these systems require NO fabrication, NO floorpan cutting, and NO welding to the body or frame. The AirBar is also positioned inside the framersails to allow much needed extra rear tire clearance. Don't settle for 50-year old technology... serious performance CAN come in a box!

INCLUDED COMPONENTS

SUGGESTED COMPLETE PACKAGE

One Piece Frame
18889

Two Piece Frame
18890

\$4600

FRONT

- Lower StrongArms..... 11012899 **\$725**
- Upper StrongArms..... 11013699 **\$525**
- HQ Series CoilOvers... 11013510 **\$750**
- MuscleBar 11019100 **\$425**

REAR

- 4-Link (1pc frame)..... 11027199 **\$1475**
- 4-Link (2pc frame)..... 11037199 **\$1475**
- HQ Series CoilOvers... 11016510 **\$700**

UPGRADES

- Drop Spindles..... 11019300 **\$400**



AIR SUSPENSION



COMPLETE PACKAGES

FRONT & REAR AIR SUSPENSION SYSTEMS

The RideTech system offers a more economical solution to gain the advantage of riding on air. The front HQ Shockwaves are used up front for easy, bolt-on installation and to eliminate tire clearance problems caused by shock relocations. A Bolt-On 4-Link will position the rear more precisely and eliminate the flexing and instability of the leaf spring rear. See the compressor options below to choose your compressor system.

INCLUDED COMPONENTS

SUGGESTED COMPLETE PACKAGE

One Piece Frame
18891

Two Piece Frame
18892

\$4975

FRONT

- Lower StrongArms..... 11012899 **\$725**
- Upper StrongArms..... 11013699 **\$525**
- HQ Series Shockwaves..... 11013001 **\$925**
- MuscleBar 11019100 **\$425**

REAR

- 4-Link (1pc frame)..... 11027199 **\$1475**
- 4-Link (2pc frame)..... 11037199 **\$1475**
- HQ Shockwaves 21140701 **\$925**

UPGRADES

- Drop Spindles..... 11019300 **\$400**



COMPRESSOR SYSTEMS



RidePro® Analog Control

4000 Series 3 Gallon	30154000	\$1,125
4100 Series 5 Gallon	30154100	\$1,325



RideProX® Digital Control

4000 Series 3 Gallon	30434000	\$1,800
4100 Series 5 Gallon	30434100	\$2,100



AirPOD

4000 Series 3 Gallon	30414000	\$2,200
4100 Series 5 Gallon	30414100	\$2,500

ridetech **StreetGRIP**

Looking to replace your tired old suspension but don't want to break the bank? StreetGrip is your solution! Replacing these key components will improve stance, ride quality, handling, and reliability!

ONE BOX...ONE SOLUTION !



**1955-1957 Chevy
Complete System**

FEATURES:

- Easy to install – direct replacement for factory suspension – no other modifications necessary
- RADICAL improvement to ride quality and handling performance
- Composite rear leafsprings offer linear spring rate and save up to 50 lbs of unsprung weight!
- Vehicle-specific Dual- rate front coilsprings offer the best of both worlds...ride quality AND crisp handling
- Delrin front control arm bushings eliminate unwanted movement and sticktion in front suspension
- Tall ball joints dramatically improve oem camber curve to give your car a much more stable feel through the corners
- Larger front swaybar minimizes unwanted body roll through the corners
- Delrin swaybar bushings eliminates unwanted movement and sticktion in the swaybar to improve ride quality and handling performance
- Vehicle-specific RideTech HQ series rebound adjustable shocks offer the ultimate in ride quality and handling performance

Car Small Block
18437 **\$2500**
Car Big Block
18438 **\$2500**

Wagon Small Block
18893 **\$2500**
Wagon Big Block
18894 **\$2500**

Components



DUAL RATE COIL-SPRINGS

The dual rate spring will allow the vehicle to transition small road irregularities via a soft spring rate. When the vehicle compresses the spring far enough [through large bumps or cornering], it transitions to the firmer spring rate to control the bump or body roll. We have worked closely with Hyperco to develop custom dual rates to ensure the best ride possible.

SB= Small Block BB= Big Block

Part#	Price
SB-18439	\$225 pair
BB-18440	



TALLER BALL JOINTS

Most oem front suspension geometry, in addition to being designed over 50 years ago, induced "positive camber" when cornering [loaded tire leans away from the turn]. This is a huge compromise in cornering performance and feel. By installing a taller set of balljoints, we reposition the control arms to correct this condition and create a much more stable and enjoyable driving and cornering experience.

Part#	Price
18445	\$50 each



LARGER FRONT SWAYBAR

Most oem front swaybars were calibrated with tires and cornering loads that were radically less capable than today. We increase the diameter of the swaybar, to minimizing the body roll through the corners and optimizing the handling performance. Includes delrin bushings to eliminate sticktion and allow the swaybar to move freely.

Part#	Price
18442	\$350



FRONT ADJUSTABLE MONO TUBE SHOCKS

Shocks are the brains of your suspension...the single most important influence on ride quality and handling performance. RideTech and Fox have spent years refining the characteristics of these monotube shocks to optimize the performance of YOUR car!

Part#	Price
17554	\$185 each



DELTRIN CONTROL ARM BUSHINGS

OEM rubber control arm bushings allow too much deflection on the control arms. Poly bushings resist smooth rotation and impose sticktion. Delrin bushings eliminate the deflection AND the sticktion, leading to a huge improvement in both ride quality and handling.

Part#	Price
18444	\$300 set



COMPOSITE LEAFSPRINGS BUSHINGS & SHOCKS

50 lb weight savings in unsprung weight will improve handling and ride quality. These composite leaves also incorporate more torsional strength so any "spring wrap" is diminished. The billet leaf spring eyelets help achieve the desired stance. Delrin bushings and adjustable shocks complete the package.

- leafsprings bushings and shocks are required as a package.

55-57 CAR			55-57 Wagon		
Part#	Price		Part#	Price	
18441	Leaf springs	\$750 set	18441	Leaf springs	\$750 set
18443	Bushings	\$250 set	18443	Bushings	\$250 set
18895	Shocks	\$550 set	18896	Shocks	\$550 set

WARNING! Products on these pages may contain chemicals known to the State Of California to cause cancer and/or birth defects or reproductive harm. www.p65warnings.ca.gov

MORRISON



**GT SPORT
CHASSIS**

Give Any Tri-5 Chevy Sports Car Handling!

Simply replace the 50-plus year-old chassis with Art Morrison's computer-designed "GT Sport" package!

It's been over a thousand GT Sport chassis ago that our "Project GT55" debuted to rave reviews and literally helped fuel the "resto mod movement." The concept of taking a classic design like the Tri-5 Chevy and giving it superior handling, an improved ride, and a contemporary stance has certainly resonated with a large number of enthusiasts. Our "Project GT55," which was equipped with a healthy 530 horsepower SBC crate motor and T-56 6-speed tranny, was initially put through its paces by the editors of Super Chevy magazine and recorded impressive numbers in acceleration, braking, skid pad and slalom that put many exotic sports cars to shame.

Now we've made a good thing even better. We started up front, developing the "Sport IFS" front suspension package. It features more aggressive geometry, heavy-duty control arms and larger polyurethane bushings. Benefits include improved high

speed stability, the ability to run larger front tires, minimized nose-diving in hard braking and better overall handling.

The latest development is the availability of our remarkable new Multilink I.R.S. in Tri-5 GT Sport chassis. This attribute clearly optimizes the handling characteristics of any "shoebox" Chevy and leaves nothing on the table.

Of course, the fundamental beauty of the AME GT Sport chassis is that it's a virtual "bolt-on" installation. You can literally unbolt the body from the OEM frame and slide a GT Sport chassis into place. While many of the nation's top pro builders use GT Sport chassis, many do-it-yourselfers have successfully installed them.

Whatever your performance goals are, AME can configure at GT Sport chassis to meet those needs. Let our tech consultants help you achieve those goals.



Starting at \$17,595.00 each

Make a good thing even better by equipping your Tri-5 with the new AME Multilink IRS. It's an available option that will set your ride apart from others. It's much quieter than conventional setups, too.

An Art Morrison GT Sport chassis was selected as the foundation for Street Rodder magazine's 2011 Tour Car. Street Rodder's Jerry Dixey put over 20,000 miles on the car during the course of the year-long promotion, with glowing reports on the car's handling and ride. With over a thousand Tri-5 Chevys now equipped with GT Sport chassis, it has become the standard of excellence for resto-mod projects.



The GT55 (shown in its original paint on the next page for the Super Chevy test) earned a "Top 5" spot for Street Machine of the Year from Goodguys and subsequently went on a year-long tour. It was also featured on "The Smoking Tire" show. Use the barcode scanner on your smart phone and link up to footage with "The Smoking Tire" review of the GT55.



Technical Features & Benefits

The AME Tri-5 chassis is designed for optimum roll center stability under all conditions. The roll center is maintained almost perfectly thru the first 3° of body roll and beyond 3° the roll center movement is minimized resulting in a suspension that is vastly improved over a Mustang II type suspension. And the rate of vertical movement is almost 1:1 with suspension movement, while the path it follows during transitions (braking, cornering, acceleration) is very smooth. This results in very consistent, stable and predictable vehicle handling.

Caster

Caster has been increased to +5° (from normal +2°) to provide improved stability at speed. This also improves the tire contact patch and weight distribution under cornering.

Camber Curve & Anti-Dive

Due to the design of the control arm angles, camber control is enhanced throughout the four inches of suspension travel, while minimizing side movement of tire contact patch (side scrub). The side angle of the control arm contributes to increased anti-dive for better stability under hard braking, while serving to provide a smooth and supple ride.

Bumpsteer

The bumpsteer curve has been designed to match camber and caster curves. The vehicle will track straight with minimal steering correction—even on bumpy pavement.

Ride Height

Vehicle will be approximately 3-4 inches lower than stock. To make the vehicle any lower, the recommended method is to use dropped spindles.

Specifications:

Wheelbase: 115 inches
 Frame: Mandrel-bent 2"x4" rectangular tubing
 Assembly: Fixture welded Finish: Bare metal only.

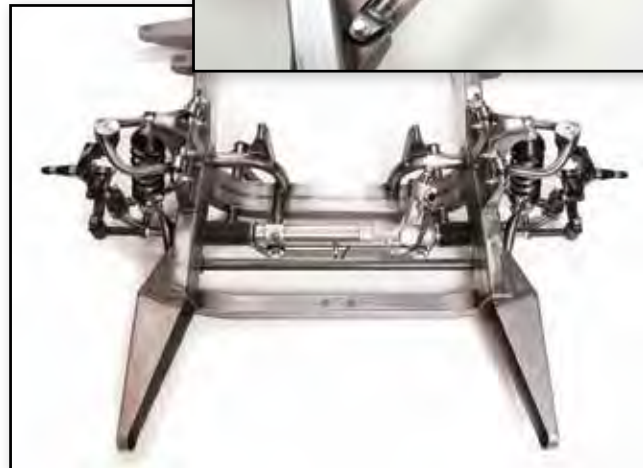

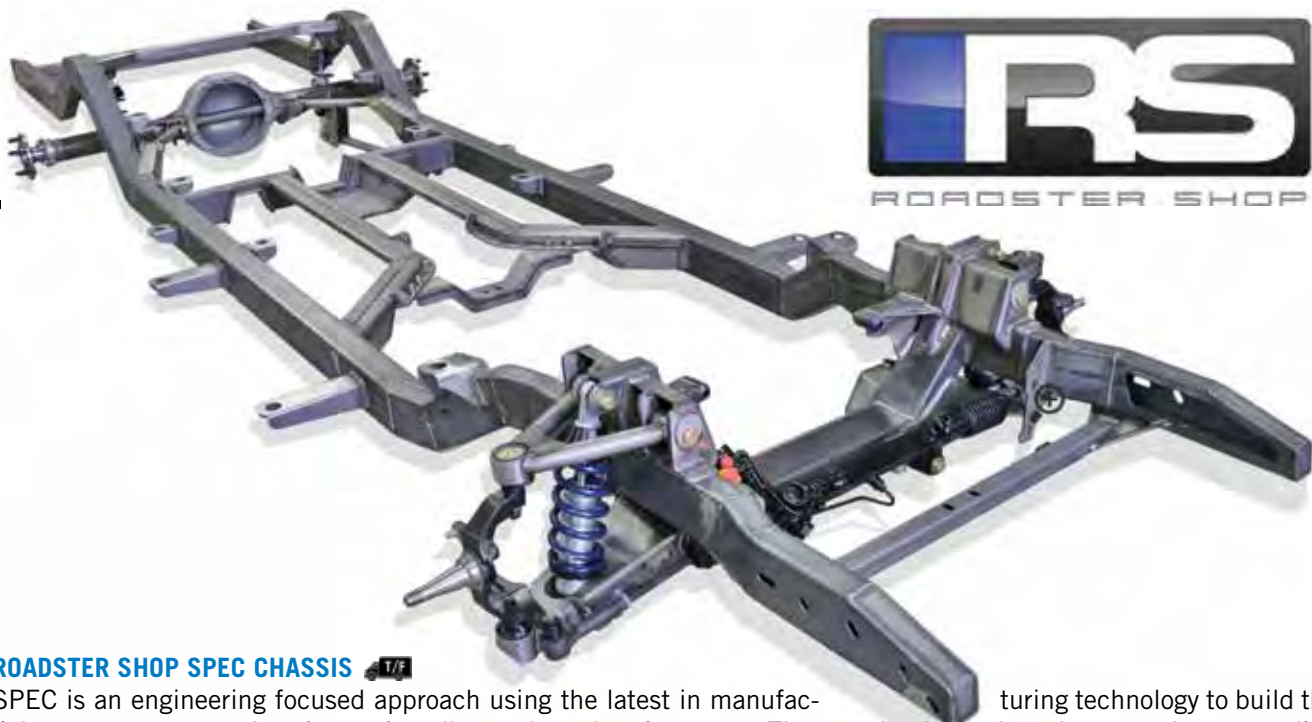

ROADSTER SHOP SPEC CHASSIS T/F

SPEC is an engineering focused approach using the latest in manufacturing technology to build the lightest, strongest, and easiest to install complete chassis system. These technologies have been used to streamline procedures resulting in lower cost and shorter lead times. The SPEC IFS is engineered to deliver outstanding performance wrapped up in user friendly package. A completely new proprietary suspension geometry has been designed to provide the best balance of ride quality and performance in its class for your Tri-Five Chevy. NO ADDITIONAL DISCOUNTS APPLY.

The Benefits:

- 1.) No kinks, bends or stressed areas that are prone to flex like mandrel bent tubing.
- 2.) Ability to contour to stock floors for no floor modifications on most applications.
- 3.) Stronger, lighter, and more precise.
- 4.) CNC located factory mounts built into the frame for easy, vehicle specific installation.
- 5.) No need to work with a weak, twisted 60 year old frame.

CHASSIS

- Exclusive "Laser Rails" precision CNC laser cut and contoured
- Crossmembers and chassis bracing to allowing for 3 exhaust
- Engine mounts for SBC, BBC, or optional LS & LT
- Adjustable, drop out trans mount
- No floor modifications required for chassis installation
- Trans tunnel mods may be necessary for larger T-56 and 4L80 transmissions
- Utilizes factory body, bumper, and core support mounts for a true bolt-on installation

SPEC IFS

- Single adjustable billet coilovers
- Power rack & pinion steering
- Accurate alignments w/adjustable upper a-arm eccentric mounts
- Wilwood Pro Spindle
- Parallel 4-Bar Rear suspension
- Single adjustable billet coilovers
- Ford 9 housing with 31 spline axles
- Rear frame rails will accommodate up to a 345 tire (when mini-tubbed)

BASE PRICE FOR ROADSTER SHOP STANDARD CHASSIS

1955-57 #19057 \$10495.95/ea.

FRONT SWAY BAR FOR ROADSTER SHOP SPEC CHASSIS

Be sure to add the Roadster Shop sway bar for your chassis. This sway bar is designed and engineered specifically for the SPEC chassis for optimum performance and will fit the factory chassis. NO ADDITIONAL DISCOUNTS APPLY.

1955-57 Add-On..... #19058..... \$395.95/ea.

BRAKE LINE KIT ROADSTER SHOP SPEC CHASSIS

Add this finishing touch to your SPEC chassis order while saving tons of time with a custom bent brake line kit from the Roadster Shop. NO ADDITIONAL DISCOUNTS APPLY.

1955-57 Add-On..... #19059..... \$795.95/kit

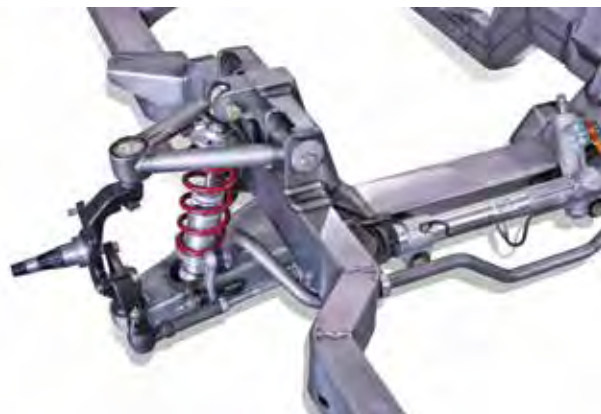

10. Brakes & Wheels

SECTION AT A GLANCE:

Disc Brake Conversion Kits	447
Baer Brake Kits	453
Wilwood Brakes	454
Dropped Spindles	458
Proportioning Valves.....	459
Power Brake Conversion	460
Brake Boosters	461
Master Cylinder	462
Vacuum Pump.....	465
Brake Rotors	466
Brake Drum	467
Brake Hoses.....	468
Brake Hardware	469
Parking Brake.....	470
Emergency Brake.....	471
E-Brake Kit	472
Brake Lines.....	474
Roller & Wheel Bearings.....	476
Wheels	477
Wheel Spinners	477
American Racing	479
Wheel Covers	480
Cragar Wheels	481
American Legend Wheels	482
Tires	484



STANDARD

UPGRADED



STOCK SPINDLE FRONT DISC BRAKE CONVERSION COMPONENTS O/S

Standard kit contains rotors, calipers, pads, seals, bearings and rubber hoses. The performance upgrades feature stainless brake hoses and cross-drilled and gas slotted rotors for use with our #797 brake kit stock spindles only. Will not clear '57 stock wheels. See page 476 for stock style wheels for disc brakes. Parts #2700 and #14262 use an 11-inch rotor.

1955-57 w/ Standard Rotors & Hoses (Shown).....	#2700.....	\$332.95/kit
1955-57 w/ Performance Rotors & Hoses.....	#14262.....	\$419.95/kit

2-INCH DROPPED SPINDLE FRONT DISC BRAKE CONVERSION KITS O/S

Standard kit includes rotors, calipers, pads, seals, bearings and rubber hoses. The Performance Upgrades feature stainless brake hoses and crossed-drilled and gas slotted rotors for use with our #2089 2-inch dropped spindles kits.

1955-57 w/ Standard Rotors & Hoses.....	#2703.....	\$309.95/kit
1955-57 w/ Performance Rotors & Hoses.....	#14263.....	\$391.95/kit

FRONT TO REAR BRAKE LINES FOR DISC BRAKE CONVERSIONS O/S

Front line from proportioning valve to caliper hose. Rear line from proportioning valve to rear end hose. For disc brake conversions. Complete set from proportioning valve to rear cylinders. Runs outside the frame.

1955-57 Steel.....	#10122.....	\$134.95/set
1955-57 Stainless.....	#10123.....	\$179.95/set



COMPLETE MIN-OFFSET FRONT DISC BRAKE CONVERSION KITS O/S

This all-in-one minimum offset front disc brake kit includes calipers, cross drilled and slotted rotors, an 8-inch dual booster/master/prop-valve assembly, stainless hoses, all necessary hardware, brackets and pre-bent lines. Dropped spindle kit is for CPP 2-inch dropped spindles. Will not clear stock 1957 14-inch wheels. See page 460 for an offset power brake booster bracket, part # 15272 for tall valve cover and OE power steering system applications.

1955-57 Stock Spindles	#15266.....	\$759.95/kit
1955-57 Dropped Spindles, Included.....	#15267.....	\$859.95/kit

MIN-OFFSET FRONT DISC BRAKE CONVERSION KITS FOR USE WITH STOCK SPINDLES O/S

Minimum offset kits for stock spindles move the wheels out 3/8-inch compared to 7/8-inch in other kits. Kits include; caliper brackets, calipers, rotors, bearings, seals, dust caps, hoses, and hardware for a hassle free installation. Works with 14-inch disc brake wheels. Does not include booster, master cylinder or pre-bent lines.

1955-57 w/ Performance Rotors & Hoses	#15254.....	\$548.95/kit
1955-57 w/ Standard Rotors & Hoses	#15255.....	\$448.95/kit



MIN-OFFSET FRONT DISC BRAKE CONVERSION KITS WITH DROPPED SPINDLES O/S

Minimum offset kits for drop spindles move the wheels in 3/16-inch from original. Kits include; dropped spindles, caliper brackets, calipers, rotors, bearings, seals, dust caps, hoses, and hardware for a hassle free installation. Will not clear stock '57 14-inch wheels.

1955-57 w/ Performance Rotors & Hoses	#15256.....	\$598.95/kit
1955-57 w/ Standard Rotors & Hoses	#15257.....	\$498.95/kit

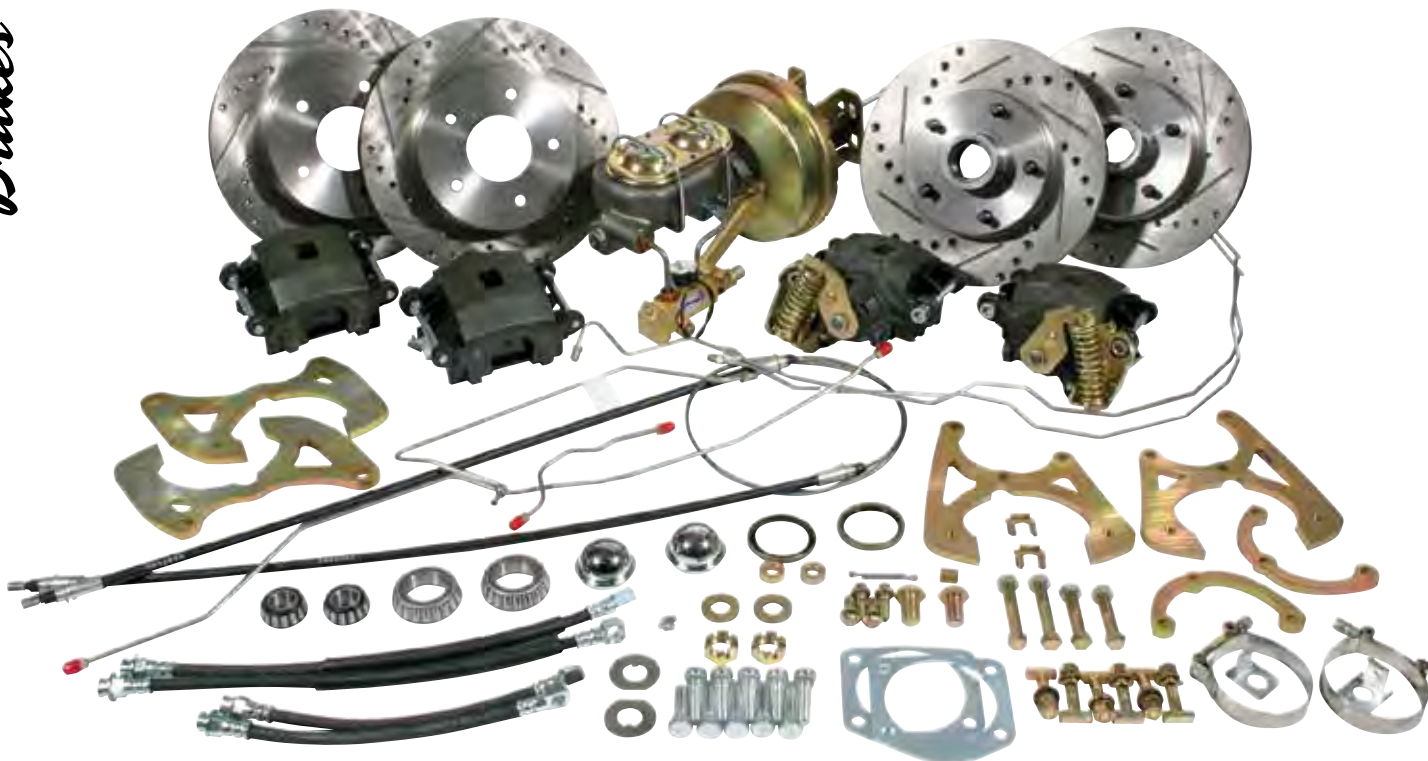

4-WHEEL DISC BRAKE CONVERSION KITS O/S

You've been asking for a single part number, all in one, 4-wheel disc brake kit and here they are. These kits use the minimum offset front disc brake kit and stock rear end rear disc brake kit. You get calipers, cross drilled and slotted rotors, an 8-inch dual booster/master/prop-valve assembly, all necessary hardware, brackets, cables, front hoses and pre-bent brake lines. You will need to purchase a front to rear frame brake line and rear flex hose or reuse your existing parts. Will not clear stock 1957 14-inch wheels. For part #15264, see page 460 for an offset power brake booster bracket, part # 15272 for tall valve cover and OE power steering system applications.

1955-57 Stock Spindles	#15264.....	\$1519.95/kit
1955-57 w/ Dropped Spindles	#15265.....	\$1449.95/kit
1955-57 w/ Dropped Spindles, Chrome Booster	#16494.....	\$1749.95/kit
1955-57 Stock Spindles, Chrome Booster.....	#16495.....	\$1649.95/kit



FRONT DISC BRAKE CONVERSION KIT BRACKETS USA

This simple kit bolts on to your existing stock spindles. Each kit contains adapting brackets, hardware and instructions that will inform you which parts are necessary for your application. We carry the rotors, calipers, master cylinder, power booster, and proportioning valve. This kit is extremely well engineered. We wouldn't short-sell your safety! (**Note:** Check your tire clearance before installation. This kit will increase the width of your car by as much as 7/8-inch per side.) **Made in the USA.**

1955-57	#797.....	\$129.95/kit
---------------	-----------	--------------



BIG BRAKE DISC CONVERSION KITS O/S

Big Brake Kits use a 13-inch rotor up front and a 12-inch on the rear. They feature red powder coated calipers, braided steel hoses, aluminum hubs, Zinc washed cross drilled and slotted rotors, rear cables and all the needed brackets and hardware to get the job done right. Part #15263 includes a dropped spindle. When installing the front and rear kit, #15262, you will need to purchase a front to rear frame line and rear flexible hose or reuse your existing parts. 17-inch or larger wheel is required for clearance.

1955-57 Front, Stock Spindles, 13"	#15260.....	\$899.95/kit
1955-57 Rear, Stock Rear End, 12"	#15261.....	\$799.95/kit
1955-57 Front & Rear, Stock Spindles & Rear End	#15262.....	\$1650.95/kit
1955-57 Front w/ Dropped Spindle, 13"	#15263.....	\$995.95/kit
1955-57 Rear w/ Ford 9" Rear End, 3/8" Flange Stud, 12"	#16358.....	\$699.95/kit
1955-57 Rear w/ Ford 9" Rear End, 1/2" Flange Stud, 12"	#16359.....	\$699.95/kit
1955-57 Rear w/ 10/12 Bolt Rear Ends, 12"	#16944.....	\$749.95/kit





REAR END DISC BRAKE KITS O/S

Get the ultimate in braking power by converting to four wheel disc brakes with a rear disc brake conversion kit. More consistent stopping and less fade than the original drum brakes. For stock and 10/12 bolt rear ends only. Easy bolt-on installation. Kit includes 11-inch rotors, calipers with built-in E-brake, rubber hose kit and all mounting hardware. Upgraded versions come with braided stainless hoses and cross-drilled and gas slotted rotors. Not for use with factory style 14 or 15-inch steel wheels.

1955-64 Stock Rear End, w/ Standard Rotors & Hoses	#2701A.....	\$784.95/kit
1955-64 Stock Rear End, w/ Performance Upgraded Rotors & Hoses.....	#14264.....	\$784.95/kit
1955-57 10/12 Bolt Rear End w/ Standard Rotors & Hoses	#16945.....	\$599.95/kit
1955-57 10/12 Bolt Rear End w/ Performance Rotors & Hoses	#16943.....	\$729.95/kit

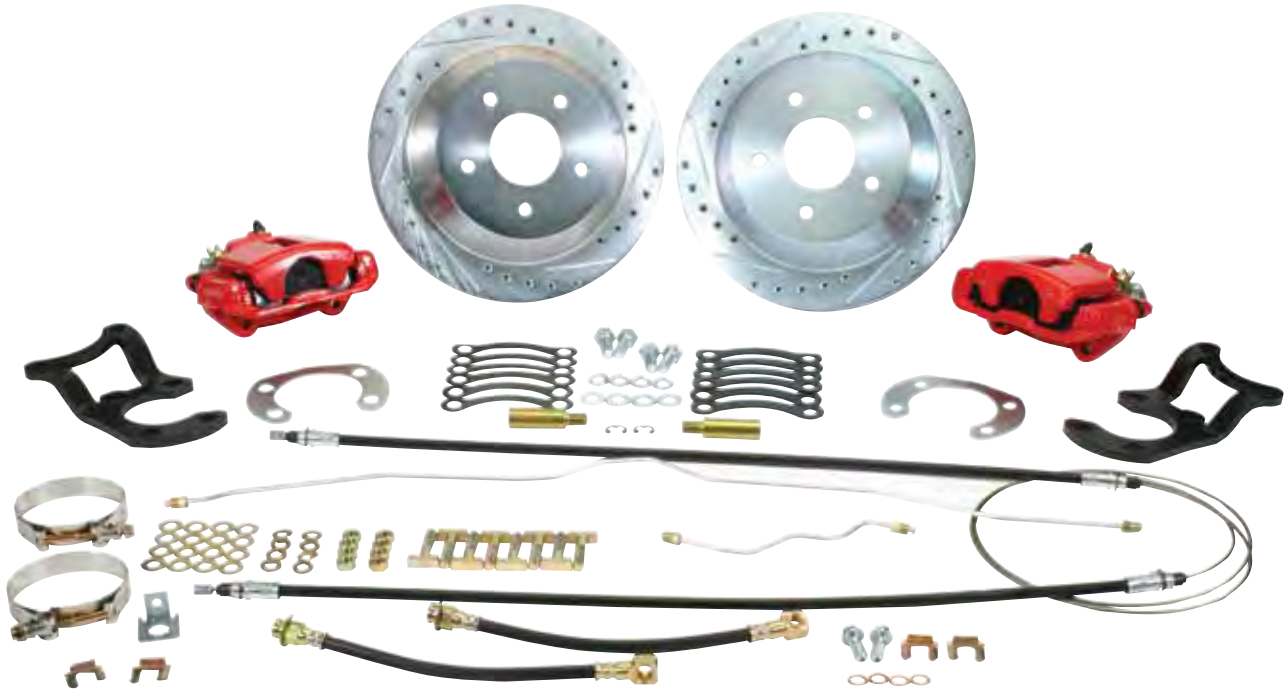

REAR DISC BRAKE KITS FOR FORD 9-INCH REAR END O/S

If you have installed a Ford 9-inch rear end in your classic and want to have rear disc brakes, this is the kit for you. This complete kit will work for both small and large bearing Ford 9-inch rears and comes with everything you need to install it on your classic. Part #16240 includes standard 11-inch brake rotors, calipers and rubber hoses, while part #16241 includes 11-inch performance drilled/slotted brake rotors, calipers and braided stainless steel hoses.

1955-57 w/ Standard Rotors & Hoses	#16240.....	\$599.95/kit
1955-57 w/ Performance Rotors & Hoses	#16241.....	\$738.95/kit



BAER SS4 REAR DISC BRAKE KITS O/S

The SS4 Rear system was designed to go along with their Track4 front offering. This features a 12-inch 1-piece rotor with a drum in hat park brake with a full billet backing plate.

1955-57 12"..... #17287..... **\$1295.95/kit**

The SS4+ 13-inch rear is a great option for those looking at the Pro+ front, or Extreme+ front that doesn't need or want that big of a brake on the rear. The SS4+ 13-inch features a 13-inch 2-piece rotor with a drum in hat park brake.

1955-57 13"..... #17288..... **\$1395.95/kit**

BAER BRAKE SS4+ FRONT OE SPINDLE DISC BRAKE KIT O/S

The SS4+ front system features all the benefits of their larger brake systems just in a smaller package to fit 15-inch wheels. This is a perfect system for those looking to retain a factory type 15-inch wheel, or the enthusiast that wants to have a larger brake with the option to go back to that stock look.



1955-57 11"..... #17281.... **\$1095.95/kit**

BAER BRAKE PRO+ FRONT OE SPINDLE DISC BRAKE KIT O/S

The Pro+ will allow you to upgrade to a 2-piece rotor (a popular upgrade due to cosmetics and weight savings) and give you 6 piston calipers. This is the first system they offer that will allow you to have the exact same looking brake front and rear! (Note: Baer is the only company to offer this). The SS4+ rear option is a cost effective, cosmetically matching rear option as well!



1955-57 13"..... #17283.... **\$2445.95/kit**

BAER BRAKE TRACK4 FRONT OE SPINDLE DISC BRAKE KIT O/S

The Track4 is Baer's most popular front offering. The Track4 is available with 13-inch 1-piece rotors and is a great brake upgrade for those looking to fill your 17-inch wheels, update your car to a modern brake and have a great visual impact! Comes complete with everything needed to mount to the corners on the car. Looking for a matching rear kit? Check out the SS4 as a matching rear option with park brake. See parts #17287-#17288, shown above.



1955-57 13"..... #17282.... **\$1795.95/kit**

BAER SS4+ FRONT DISC BRAKE KIT FOR HEIDT'S SPINDLES O/S

1955-57 11"..... #17284.... **\$1295.95/kit**

BAER TRACK4 FRONT DISC BRAKE KIT FOR HEIDT'S SPINDLES O/S

1955-57 13"..... #17285.... **\$1795.95/kit**

BAER PRO+ FRONT DISC BRAKE KIT FOR HEIDT'S SPINDLES O/S

1955-57 13"..... #17286.... **\$2445.95/kit**

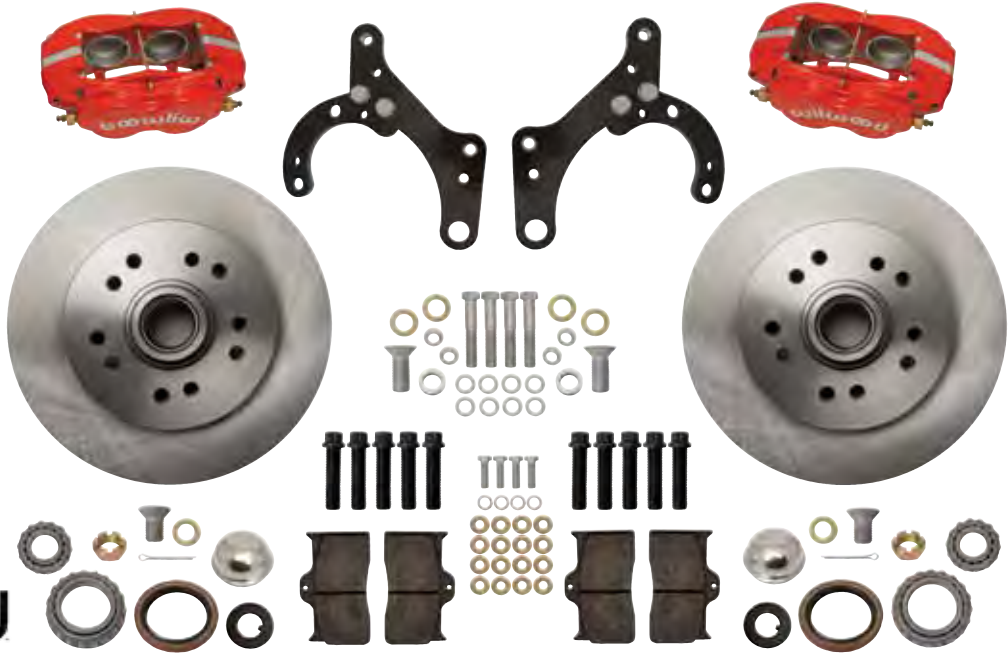

WILWOOD CLASSIC SERIES FRONT BRAKE KIT O/S

Wilwood's Classic Series front disc brake kits offer disc brake upgrade solutions for many OEM drum or disc spindles. These kits feature the FDL-M four piston forged aluminum calipers and 11.5-inch diameter one-piece rotors provide superb dimensional stability and wear resistance. These versatile kits can be used with either manual or power boost master cylinders, and come complete with calipers, rotors, brackets, hardware and detailed installation instructions.

1955-57 OE Spindles, Black Calipers, 11.5"	#19295.....	\$599.95/kit
1955-57 OE Spindles, Red Caliper, 11.5" (Shown)	#19296.....	\$599.95/kit
1955-57 CPP Drop Spindles, Red Calipers, 11.5"	#19297.....	\$599.95/kit
1955-57 CPP Drop Spindles, Black Calipers, 11.5".....	#19363.....	\$599.95/kit



WILWOOD FNSL6R FRONT DISC BRAKE KIT O/S

Wilwood's FNSL6R billet Forged six-piston calipers with 13-inch rotors deliver the ultimate combination for braking power and style for traditional non-ABS spindles on American muscle cars. Requires 17-inch and larger wheels.
All Drop Spindles #18537... \$1699.95/ea.



WILWOOD DYNA PRO 6 FRONT DISC BRAKE KIT O/S

Wilwood's DynaPro 6 six piston forged billet calipers combined with 12.19-inch diameter rotors offer an enhanced brake capacity and pad performance alternative to the bigger six piston kits.
All 12.19" , W-DP6P, Red..... #18538... \$1229.95/ea.



DISC BRAKES
wilwood

WILWOOD MASTER CYLINDERS

Wilwood's tandem aluminum master cylinders feature fluid ports on both sides of the bore and the slotted flange mounting means it will fit most domestic cars and trucks from the mid 1960's to present. Stroke is set at 1.1-inch with a volume ratio of 2:1 between the primary and secondary chambers. Machined from high-pressure die castings, each master cylinder weighs 3 pounds.

- All 1-1/8" Bore, Polished #18550..... \$239.95/ea.
- All 1" Bore, Polished #18551..... \$239.95/ea.
- All 7/8" Bore, Polished #18552..... \$239.95/ea.
- All 1-1/8" Bore, Black #18553..... \$239.95/ea.
- All 1" Bore, Black..... #18554..... \$239.95/ea.
- All 7/8" Bore, Black..... #18555..... \$239.95/ea.



WILWOOD MASTER CYLINDER KITS WITH COMBO VALVE

Wilwood has packaged their popular aluminum tandem chamber master cylinder with their combination proportioning valve, mounting bracket, fluid tubes and mounting hardware in a kit. The slotted flange mounting makes the master cylinder a simple bolt on, compatible with manual or power brake system applications. The Wilwood combination proportioning valve substantially simplifies wiring and brake proportioning adjustments on vehicles with custom brake systems. The combination block maintains full isolation between front and rear fluid circuits and is specifically designed to accompany the master cylinder. The combo valve and bracket are black E-coated for a performance look and the stainless steel fluid tubes are precision bent with pre-installed stainless tube nuts.

- All 1-1/8" Bore, Polished #18544..... \$359.95/kit
- All 1" Bore, Polished #18545..... \$359.95/kit
- All 7/8" Bore, Polished #18546..... \$359.95/kit
- All 1-1/8" Bore, Black #18547..... \$359.95/kit
- All 1" Bore, Black..... #18548..... \$359.95/kit
- All 7/8" Bore, Black..... #18549..... \$359.95/kit



WILWOOD RESIDUAL PRESSURE VALVES

Wilwood's two pound and ten pound residual pressure valves retain a minimum brake line pressure to help eliminate excessive pedal travel in both disc and drum brake systems. The two pound valve is used in disc brake applications where the master cylinder is mounted below the horizontal plane of the calipers and fluid drain back occurs from gravity and vibration, thereby causing excessive caliper piston retraction and a longer brake pedal stroke. The minimal two pound residual pressure prevents fluid from flowing back without causing the brakes to drag. With drum brakes, a ten pound valve is used to compensate for return spring tension and maintain wheel cylinder sealing in the drums.

- All 10-lb..... #18539..... \$19.95/ea.
- All 2-lb..... #18540..... \$19.95/ea.

WILWOOD UNIVERSAL MASTER CYLINDER PUSHROD KIT

Wilwood's universal brake pedal pushrod kit allows many common configurations for custom installation of power boosters or manual master cylinders. Adjustable length kit contains all the necessary components for pedal engagement and height adjustment for most common types of installations. Kit includes: adjustable length pushrods, unions, clevis, eyelet and retainer.

- All..... #18541..... \$59.95/ea.





WILWOOD PROPORTIONING VALVE COMBO

With their new proportioning / combo valve and bracket kit Wilwood has created an elegant way to mount the master cylinder and prop / combo valve as a unit. This kit is specifically designed to work in conjunction with Wilwood aluminum tandem master cylinders in manual or boosted system applications. Kit includes: stainless steel fluid tubes precision bent with preinstalled stainless tube nuts for a simple bolt-on installation between the combination proportioning valve and the Wilwood tandem master cylinder, mounting hardware, bracket and prop/combo valve.

All w/ Mount Bracket, Left Hand... #18542.....\$119.95/kit

WILWOOD PROPORTIONING VALVE COMBO

Wilwood's new combination proportioning valve substantially simplifies mounting, plumbing, wiring and brake proportioning adjustments on vehicles with custom brake systems. The combination block maintains full isolation between front and rear fluid circuits and can be used in conjunction with any tandem outlet or dual mount master cylinder assemblies. The rear circuit has a single inlet and single outlet with the adjustable proportioning valve. The front circuit has a single inlet with two outlets. It can be run as a single outlet with one outlet plugged, or used to split the plumbing on its way to the front calipers.

All Black #18543.....\$89.95/kit



WILWOOD STAINLESS DISC BRAKE HOSES

Wilwood's rear disc conversion stainless steel braided flexline kits are manufactured to high quality standards and include all the required fittings. The two hoses are 12-inch long and come with two 90° 1/8-inch -27 NPT fittings, two straight -3 to 3/8-24 IF chassis fittings and two line clips.

All Rear..... #18556.....\$83.95/pr.

Wilwood highly recommends using these top quality flexlines as replacement for the OE rubber hoses when doing your front disc brake conversion upgrade. The two hoses are 16-inch long and come with two 90° 1/8-inch -27 NPT fittings, two straight -3 to 3/8-24 IF chassis fittings and two line clips.

All Front (Not Shown)..... #18557.....\$71.95/pr.

WILWOOD BRAKE FLUID

Wilwood EXP Super Hi-Temp 600 Plus DOT 4 Racing Brake Fluid has been specially formulated for racing applications where brake systems consistently operate at very high temperatures. In addition to guarding against vapor lock, EXP Super Hi-Temp 600 Plus Racing Brake Fluid maintains its viscosity and lubricity under extreme temperatures for maintaining brake system reliability and performance.

All EXP6000 Plus DOT 4, 16.5 oz.

..... #18535..... \$19.95/ea.



WILWOOD

WILWOOD RACING BRAKE FLUID

Wilwood's specially formulated Hi-Temp° 570 DOT 3 Racing Brake Fluid has a minimum 570° F. dry boiling point to withstand the severe heat requirements of automotive racing. Hi-Temp° 570's low viscosity allows easy bleeding of your brake system, eliminating aeration of the brake fluid caused by foaming due to excessive pumping of the pedal.

All 570 DOT 3, 12 oz. #18536..... \$10.95/ea.



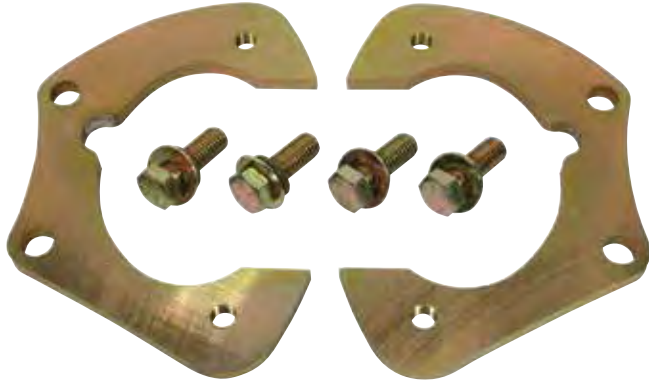

**CLASSIC PERFORMANCE
MODULAR 2-INCH
DROPPED SPINDLES**

Modular drop spindles offer you the flexibility to install either 11-inch rotors or go "BIG" with a 13-inch disc brake conversion kit. There is no loss of turning radius and they accept stock and Unisteer steering arms. When used with 11-inch rotors the wheels are moved in 3/16-inch, with the 13-inch rotors they are moved out 1/2-inch. Works with 15-inch or larger disc brake wheels. Will not interchange with stock height disc components.



- 1955-57 w/ Small Metric Caliper Brackets**
..... #15259.....\$299.95/pr.
- 1955-57 w/ Large Caliper Brackets**
..... #15259A....\$299.95/pr.

**FRONT BRAKE CALIPERS
WITH DISC CONVERSION
STOCK OR DROPPED
SPINDLES**

This replacement loaded metric caliper can be mounted on either side and features a larger piston for more stopping force.



- 1955-57** #12411 \$65.95/ea.

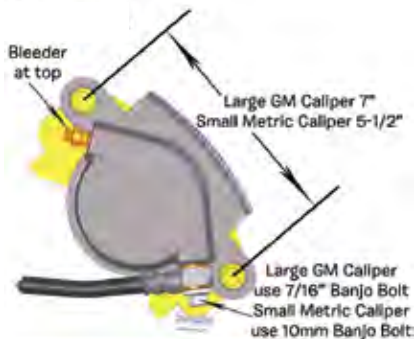

HEIDT'S 2-INCH STEEL DROPPED SPINDLES

Use part #2089 with dropped spindles brake components, part #2703 shown on page 448. Can accept large or small GM calipers. Contact Wilwood for Wilwood brackets.

- 1955-57 w/ Small Caliper Metric Brackets**
..... #2089..... \$449.95/pr.
- 1955-57 w/ Large Caliper Brackets**
..... #2089A..... \$459.95/pr.



STOCK HEIGHT SPINDLES

- 1955-57 1-Piece Forged, Drum/Disc**
..... #16977 \$159.95/pr.



STOCK SPINDLE BRAKE ROTOR

- For stock spindle disc conversions.
1955-57 #12410..... \$51.95/ea.



STOCK SPINDLE BOLTS

- 1955-57** #2696..... \$13.95/set



#2521

#2521A

PROPORTIONING VALVES

All Adjustable #2521 \$49.95/ea.
 All 2/4 Disc Brakes #2521A \$49.95/ea.

ADJUSTABLE PROPORTIONING VALVE AND DISTRIBUTION BLOCK KITS

Proportioning valve and brake light switch all-in-one. It's designed for dual reservoir master cylinders and has two inlets, two outlets for front brakes and one outlet for the rear brakes. Kits include five stainless 3/16-inch fittings, brake light switch and wiring pigtail.



All Black #15060 \$99.95/kit
 All Polished #15061 \$115.95/kit



ADJUSTABLE PROPORTIONING VALVE

All Chrome #17574 \$59.95/pr.



CHROME BRAKE PROPORTIONING VALVE KITS

1955-57 2/4 Disc Brakes #17152 \$109.95/kit



PROPORTIONING VALVE BRACKET

For use with 605 box. Will not work with stock box. Some modifications to brake lines are necessary.

1955-57 #12186 \$28.95/ea.

COMBINATION/PROPORTIONING VALVE TOOL

For brake systems utilizing preset proportioning valves (2521A/B). Use this tool when bleeding your brakes to lock the valve in place and keep it from tripping, making it difficult to properly bleed the brake system. Installs in place of the warning light switch. Replace warning light switch when bleeding is complete.



All #16941 \$11.95/pr.



PROPORTIONING VALVE BRACKET AND LINE KITS

1955-57 Chrome #17155 \$49.95/kit
 1955-57 #11205 \$16.95/kit

HYDRAULIC ASSIST POWER BRAKE CONVERSION KITS

Hydraulic assist braking systems use the power steering pump to power the hydro-boost, which means you have no problems with low vacuum like you have with traditional vacuum assist power brake systems. By going with a hydraulic assist system, which is not dependent on engine speed or engine vacuum, you don't need to mess with vacuum cans, pumps or electronic gadgets which only offer a temporary solution to low vacuum problems. Hydraulic assist systems provide substantial gains in overall braking power and the fastest braking response



time of any power brake system available. Danchuk offers 2 levels of kits to fit your particular application. Level 3 kits are ideal for floor shift cars, as they tend to interfere with stock column shift linkages. Level 4 kits give you maximum engine and column clearance and are ideal for column shift cars and tall block big block cars. Your car must have power steering to use a hydraulic assist system and these systems are designed to be used with master cylinders with a shallow bore piston. Recommended for cars with at least front disc brakes.

1955-57 w/ Lines, Level 3 (Shown)	#13983	\$699.95/kit
1955-57 w/o Lines, Level 3	#13984	\$449.95/kit
1955-57 w/ Lines, Level 4	#13985*	\$749.95/kit
1955-57 w/o Lines, Level 4	#13986*	\$524.95/kit

* **Note: Level 4 kits are recommended if car is using factory column shifter.**



RESIDUAL PRESSURE CHECK VALVES

When upgrading your stock drum brake system to disc brakes a proportioning valve is needed to ensure proper amount of pressure going to the front and rear wheels. A residual check valve is sometimes needed when using an adjustable prop valve.

All 2-lbs., Blue	#17570	\$13.95/pr.
All 2-lbs., Chrome	#17571	\$19.95/pr.
All 10-lbs., Red	#17572	\$13.95/pr.
All 10-lbs., Chrome	#17573	\$21.95/pr.



CHROME POWER BRAKE BOOSTER KITS

These are our most popular power disc brake conversion kits in chrome. They feature a chromed master, cap, bracket, prop valve and stainless lines.

1955-57 2/4 Disc Brakes, 8", Dual Diaphragm	#14322	\$599.95/kit
1955-57 2/4 Disc Brakes, 7" Dual Diaphragm	#15271	\$583.95/kit

OFFSET POWER BRAKE BOOSTER BRACKET

This bracket moves the booster 2-inch to the left and 1-3/4-inch up for additional clearance.

1955-57#15272.\$149.95/ea.



#14975

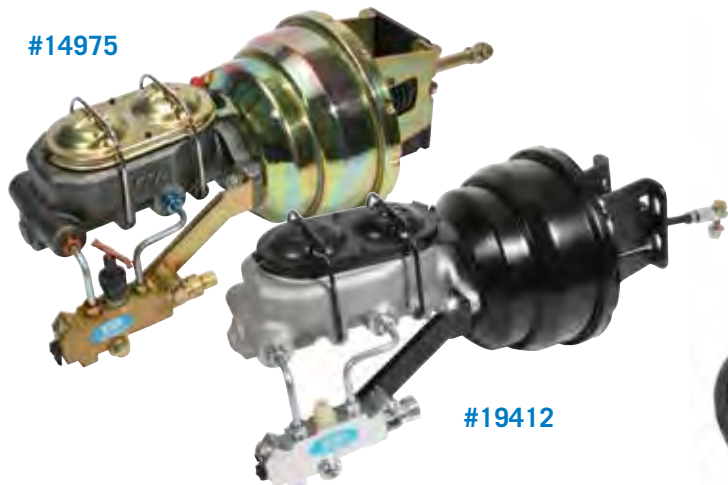

#19412

POWER BRAKE BOOSTER KITS

Update your braking system with these power brake units which provide improved braking power with minimal pedal effort. Installation is simple; just bolt the unit to the firewall and drill a new hole in the pedal arm to attach the pushrod. Dual reservoir brake systems provide an extra measure of safety, but require additional lines. Power boosters require a minimum of 17-inch of vacuum. If your engine produces less, we suggest you check out our HydroBoost systems. Power boosters will not clear factory power steering pumps/generators. For proper brake pedal effort, we recommends at least an 8-inch booster on Disc/Drum or Disc/Disc brake systems. 9-inch booster will not clear big blocks and may interfere with some small block tall valve covers. Please check clearance before ordering.

- 1955-57 Drum/Drum, 9" Single Diaphragm**
- Single Reservoir #2095..... \$299.95/kit
- 1955-57 Drum/Drum, 8" Single Diaphragm**
- #18660..... \$299.95/ea.
- 1955-57 Drum/Drum, 8" Single Diaphragm, Offset**
- #18661..... \$349.95/ea.
- 1955-57 Drum/Drum, 7" Single Diaphragm,**
- Single Reservoir #2095A..... \$299.95/kit
- 1955-57 Drum/Drum, 7" Single Diaphragm,**
- Dual Reservoir #2096A..... \$299.95/kit
- 1955-57 2/4 Disc Brakes, 7" Single Diaphragm**
- #2098A..... \$299.95/kit
- 1955-57 2/4 Disc Brakes, 7" Dual Diaphragm**
- #15269..... \$299.95/kit
- 1955-57 2/4 Disc Brakes, 8" Dual Diaphragm**
- #12157..... \$349.95/kit

OFFSET POWER BRAKE BOOSTER KIT

Same style as above but with an offset bracket that moves booster 2-inch to the left and 1.75-inch up for additional clearance. 8-inch dual diaphragm with proportioning valve.

- 1955-57 2/4 Disc Brakes..... #14976..... \$375.95/kit**

MIDNITE SERIES POWER BRAKE BOOSTER KIT

- 1955-57 Disc/Drum, Disc/Disc, 8" Dual Diaphragm,**
- Combo Valve #19412..... \$299.95/kit**



HYDRAULIC BRAKE BOOSTER KITS

The "Show Stopper" package includes hydraulic brake assist unit with aluminum firewall mounting bracket. Master cylinder, prop and stop block kit, chrome accumulator cover, stainless pressure hoses, rubber return hoses and all necessary hardware for installation.

- 1955-64 Show Stopper #17978..... \$978.95/ea.**

The "Street Beast" package includes hydraulic brake assist unit with steel firewall mounting bracket, aluminum Corvette style master cylinder, side mounted prop and stop block kit, rubber pressure and return hoses and all necessary hardware for installation.

- 1955-64 Street Beast #17979..... \$749.95/ea.**

POWER BRAKE BOOSTERS WITH BRACKETS

For those building their own brake kit or want to update to power brakes, these boosters come with the proper bracket and pedal rod, as well as long and short master cylinder pushrods to work with both shallow and deep bore master cylinders.

- 1955-57 8" Dual #16644..... \$199.95/ea.**
- 1955-57 8" Dual, Chrome #16645..... \$279.95/ea.**



#16645

TCI ROLL STOP KIT

TCI's Roll Stop allows you to do a burnout like the professionals. Simply pump the brake pedal, apply the roll stop and release the brake pedal. The roll stop keeps the front brakes applied. Kit includes the solenoid, microswitch, mounting bracket, fuse connector and mounting hardware. Brake line modification required.

- All..... #13046..... \$114.95/kit**





MASTER CYLINDERS WITH BUILT-IN ADJUSTABLE PROPORTIONING VALVES

Featuring a double adjustable proportioning valve, removable metering valve, stop light control, larger fluid capacity, and smaller size, this unit solves the problems associated with trying to plumb together four or five separate pieces. This is a master cylinder, proportioning valve, metering valve and stop light all in one package. Each contains two circuits, a front and rear. The front circuit contains the metering valve which is required on cars that have disc brakes on the front wheels and drum brakes on the rear wheels. The rear contains the adjustable proportioning valve and the maximum rear pressure adjustment. The adjustable proportioning valve controls the balance of pressure between the front and rear brakes.

- All Chrome, 1" Bore #13200..... \$189.95/ea.
- All Chrome, 1-1/8" Bore..... #15370..... \$199.95/ea.



ALUMINUM/CHROME MASTER CYLINDER ASSEMBLIES

These cast aluminum/chrome plated master cylinders are an easy upgrade to any power or manual disc brake conversion and includes chrome plated valve and bracket.

- All Disc/Drum, 1" Bore #15371 \$265.95/ea.
- All Disc/Disc, 1" Bore #15372 \$265.95/ea.
- All 2/4 Disc Brakes, 1-1/8-in Bore #15374..... \$265.95/ea.



ALUMINUM BRAKE MASTER CYLINDERS, CHROME PLATED

Works with 2 or 4-wheel disc brake applications, power or non-power.

- All 1" Bore #14977 \$139.95/ea.
- All 1-1/8" Bore #14978 \$148.95/ea.

BRAKE MASTER CYLINDER ASSEMBLY

This unit is factory fresh, not just another rebuild! For standard brakes. Some brake line modification necessary.



- 1955-57 #023 \$81.95/set

DRUM BRAKE DUAL RESERVOIR MASTER CYLINDER

This dual reservoir drum/drum master cylinder allows you to add safety by splitting the the brake system front to rear. Works with manual brakes or with boosters with a long push rod pin. Mounts to firewall using only two of the original four mounting studs. You must supply additional brake lines.



- 1955-57 #16360..... \$69.95/ea.



SMOOTH MASTER CYLINDERS

CPP's new smooth aluminum master cylinders feature a beautiful black or chrome finish with two ports, 1/2-20 in front and 9/16-18 in the rear.

- All Black, Disc, 1" Bore #18684..... \$94.95/ea.
- All Black, Disc, 1-1/8" Bore #18685..... \$94.95/ea.
- All Chrome, Disc, 1" Bore #18686..... \$115.95/ea.
- All Chrome, Disc, 1-1/8" Bore #18687 \$115.95/ea.



#18172 & #18174

#18171 & #18173

BAER REMASTER MASTER CYLINDERS

The Baer Remaster is a fully machined, billet aluminum master cylinder that features:

- Fully Machined out of aluminum in Phoenix, Arizona.
- Comes standard in Anodized Gray, Black, and Polished.
- Compact short design allows this master to fit in a wide variety of applications.
- Includes a bullet (insert adapter) for long pushrod applications.
- Machined screw-in caps for easy access to fill. Knurled caps to make removal easy.
- Bolt on Firewall mount bracket.
- Laser etched logos and part numbers for a finished look on anodized version.
- Bolt on proportioning valve block (See pn#'s 18175-76) is available separately.
- Available in 1-inch and 1-1/8-inch bores, 15/16-inch available by special order.

All 1" Bore, Gray	#18171	\$399.95/ea.
All 1" Bore, Polished	#18172	\$474.95/ea.
All 1" Bore, Black	#18177	\$399.95/ea.
All 1-1/8" Bore, Gray	#18173	\$399.95/ea.
All 1-1/8" Bore, Polished	#18174	\$474.95/ea.
All 1-1/8" Bore, Black	#18178	\$399.95/ea.



BAER REMASTER PROPORTIONING VALVES WITH MOUNTS

All Baer Remasters have the ability to bolt a proportioning valve block to the bottom of the master cylinder. These kits include the valve, block and mounting hardware.

All Gray	#18175	\$74.95/pr.
All Polished	#18176	\$84.95/pr.
All Black	#18513	\$74.95/pr.



#19468

COMPACT MASTER CYLINDERS

Wilwood's Compact Tandem Master Cylinders are designed for manual (7/8-inch, 15/16-inch, 1-inch) or power (1-inch, 1-1/8-inch) applications depending on bore size, 7/8-inch and 15/16-inch come with a pushrod, 1-inch and 1-1/8-inch do not. They are designed for mount flanges from 3.22-inch to 3.40-inch, common measurements for most domestic cars and trucks from the mid-1960's to present, and offer fluid outlet ports on both sides of the bore.

All 7/8" w/ Pushrod, Black.....	#19467	\$277.95/ea.
All 7/8" w/ Pushrod, Polished	#19468	\$277.95/ea.
All 15/16" w/ Pushrod, Black.....	#19469	\$277.95/ea.
All 15/16" w/ Pushrod, Polished ..	#19470	\$277.95/ea.
All 1" w/o Pushrod, Black.....	#19471	\$277.95/ea.
All 1" w/o Pushrod, Polished	#19472	\$277.95/ea.
All 1" w/o Pushrod, Black.....	#19473	\$277.95/ea.
All 1" w/o Pushrod, Polished	#19474	\$277.95/ea.

DISC BRAKE MASTER CYLINDERS

For 2 or 4-wheel disc brake conversions only. Be sure to order the correct proportioning valve (#2521A or #2521B) for your application.



Includes piston bore depth adapter, will work with both power and non-power brake systems.

All 1" Bore	#10252	\$39.95/ea.
All 1-1/8" Bore	#18363	\$59.95/ea.



CHROME ALUMINUM DISC BRAKE MASTER CYLINDERS

All 1" Bore	#17149	\$79.95/ea.
All 1-1/8" Bore	#17150	\$85.95/ea.



#2522

MASTER CYLINDER COVER



Another chrome favorite for the custom engine compartment! For stock master cylinders. **Made in the USA.**

1955-57 Plain..... #2522..... \$108.95/ea.



FRAME MOUNT BRAKE PEDAL/MASTER CYLINDER BRACKET

Clean up your firewall with this frame mounted pedal and booster/master cylinder bracket. This kit bolts under the floor, but is tucked up high so it won't cause ground clearance problems. Kit includes: brake pedal assembly and frame bracket. 7-inch booster/master/prop valve sold separately.

1955-57 #17209..... \$197.95/ea.



1957 BRAKE MASTER CYLINDER CAPS

1957 Numbered..... #14701..... \$27.95/ea.

1957 Un-Numbered #14702..... \$27.95/ea.

BRAKE MASTER CYLINDER CAP GASKET ONLY

1955-57 #1202..... \$2.75/ea.



BILLET MASTER CYLINDER COVERS

All Chromed..... #14984..... \$99.95/ea.

All Brushed..... #14985..... \$75.95/ea.



1957 MASTER CYLINDER AND POWER UNIT COPPER WASHERS

1955-57 #1838..... \$3.95/ea.

1957 MASTER CYLINDER TO FIREWALL GASKET

This fibrous gasket includes perforations that allow it to be installed onto the master cylinder before the master cylinder is installed into the firewall.



1957..... #1837..... \$2.50/ea.



BRAKE MASTER CYLINDER COVER

1955-57 #1953..... \$13.95/ea.

BRAKE BLEEDING SYRINGE



This tool helps speed up the master cylinder bench bleeding process. Just insert the tip in the bottom reservoir ports. Fills the piston bore with clean fluid while pushing out unwanted air. Bench bleeding the master cylinder is required when installing an new master cylinder.

All..... #16940..... \$4.95/ea.

SPEED BLEEDERS



Speed bleeder makes bleeding your brakes easier than ever. Simply replace your original bleeder valves with a one-way ball and check valve design allowing old air and fluid out, then closing between pumps to prevent air from re-entering the system.

All 3/8" x 24 #14500..... \$15.95/pr.
All 10 mm x 1.5..... #14501..... \$14.95/pr.



BRAKE MASTER CYLINDER HARDWARE SET

This hardware set fits original brake master cylinders. Replacement brake master cylinder assemblies and other related parts are shown on this and throughout the Brake section.

1955-58 #2196..... \$29.95/set

MASTER CYLINDER ADAPTER FITTINGS



Made to adapt 1/2-20 to 3/16 inverted flare and 9/16-18 to 3/16 inverted flare.

All..... #14979..... \$18.95/pr.

MASTER CYLINDER ADAPTER FITTINGS



Converts your 3/8-24 fitting master cylinder to GM's 1/2-20 and 9/16-18 lines.

All..... #17153..... \$16.95/pr.



TREADLE-VAC VACUUM HOSE KITS

1955..... #13529..... \$24.95/kit
1956-57 #13530..... \$27.95/kit



POWER BRAKE VACUUM HOSE CLAMPS

Don't settle for modern screw clamps. These spring clamps are the authentic originals.

1955-57 #033..... \$3.50/set

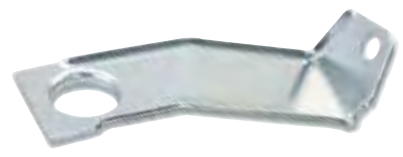

TREADLE-VAC POWER BRAKE HOSE BRACKET

1955-57 #1161..... \$12.95/ea.



TREADLE-VAC PLUNGER ROD SHOULDER BOLT

1955-57 #13528..... \$18.95/ea.



PHOTO COURTESY OF GERTMAN2000



BRAKE WHEEL CYLINDERS

1955-57 Front, Driver	#024.....	\$21.95/ea.
1955-57 Front, Passenger.....	#025.....	\$21.95/ea.
1955-57 Rear, Driver	#026.....	\$19.95/ea.
1955-57 Rear, Passenger	#027.....	\$19.95/ea.



#16326

#16327

REPLACEMENT CROSS-DRILLED AND SLOTTED BRAKE ROTORS

Parts #16325 and #16326 are replacement rotors for our front BIG BRAKE disc brake conversion kits. And the #16327 and #16328 are replacement upgraded rotor for our minimum offset disc brake conversion kits.

All Big Brake Kits, Passenger	#16325.....	\$99.95/ea.
All Big Brake Kits, Driver.....	#16326.....	\$95.95/ea.
All Minimum Offset, Passenger	#16327	\$89.95/ea.
All Minimum Offset, Driver.....	#16328	\$89.95/ea.



BRAKE SHOES

Brand new brake shoes with a premium organic lining. 100% asbestos free.

1951-58 Front Axle.....	#021.....	\$35.95/set
1951-58 Rear Axle (Shown).....	#020.....	\$35.95/set



METRIC FRONT DISC BRAKE PADS

These premium replacement front pads fit our #2700, #2703 as well as the minimum offset disc brake conversions.

1955-57 Semi Metallic (Shown)...	#12322.....	\$39.95/set
1955-57 Organic	#12323.....	\$27.95/set



REPLACEMENT BRAKE ROTOR FOR MINIMUM OFFSET KIT

Replacement rotor for our minimum offset disc brake conversion kits.

All Plain, Replacement.....	#16329.....	\$54.95/ea.
-----------------------------	-------------	-------------



BRAKE SHOE GUIDE PLATE

Goes on the return spring anchor pin.

1955-57	#16838.....	\$5.95/ea.
---------------	-------------	------------

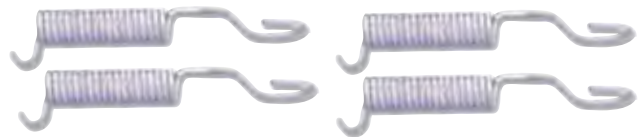

BRAKE SHOE RETURN SPRINGS

Contains four springs, a one axle set.

1955-57	#156.....	\$9.95/set
---------------	-----------	------------



BRAKE DRUM

1951-58 Front or Rear #030..... \$54.95/ea.



CROSS-DRILLED BRAKE DRUM

1951-58 Front or Rear #12821..... \$164.95/pr.



BRAKE DRUM SPRING



Close-Up

This handy little item absorbs resonance that would otherwise be transferred back into the car. Replace this spring when rebuilding the brakes. For use with stock type drums with grooves only.

1955-57 #1503..... \$12.95/ea.

BRAKE PEDAL RETURN SPRING

Installs over the brake pedal cross shaft. The "J" end hooks around the pedal arm and the "L" shaped end hooks under the edge of the support bracket. Brings the pedal back up to resting when the brakes are released..



1955-58 #1883..... \$7.95/ea.



ORIGINAL STYLE METAL BRAKE DRUM HOLE COVERS

1955-57 #1511..... \$5.95/set

BRAKE PEDAL CROSS SHAFT NYLON BUSHING

Use our brake pedal cross shaft nylon bushing to ensure a smooth feel when you step on the brake pedal. If your bushing is damaged or missing, your brake pedal assembly will wobble. This bushing is installed into the brake pedal sleeve on the pedal assembly located under the dash. Two required per car.



1955-57 #2084..... \$6.95/ea.

RUBBER BRAKE HOLE ADJUSTMENT PLUG

Replacement. Four needed per car.

1938-75 #1153..... \$2.95/ea.



RUBBERIZED CLAMP KIT

Used for securing wiring harnesses or fuel lines. 1/2-inch ID, full circle with a 5/16-inch mounting hole. 10 pieces.



All..... #12350..... \$7.95/kit



BRAKE WHEEL CYLINDER PUSH PINS

1955-57 #18354..... \$8.95/pr.

WHEEL CYLINDER FRENCH LOCKWASHER

1955-64 Front Only..... #11228..... \$1.50/ea.





BRAIDED STAINLESS FRONT DISC BRAKE HOSE KITS
 Braided stainless hoses give you a firmer pedal feel. Upgrade your disc brakes today with this kit.
 All 16", 10 mm Banjo Bolts..... #15233.....\$69.95/kit
 All 16", 7/16" Banjo Bolt, 1/4" Brake Line
 #16364.....\$62.95/kit



RUBBER FRONT DISC BRAKE HOSE KITS
 Replacement rubber hose kit for front disc conversion kits.
 All 16" w/ 10 mm Banjo Bolt #16363.....\$49.95/kit
 All 16" w/ 7/16" Banjo Bolt, 1/4" Brake Line
 #16365.....\$49.95/kit



NOTCHED BRAIDED LINE CLAMP KITS
 All -3AN, 1/4", 6-Pack..... #19071.....\$16.95/kit
 All -4AN, 7/16", 6-Pack..... #19072.....\$16.95/kit
 All -6N, 9/16", 6-Pack..... #19073.....\$18.95/kit
 All -8N 5/8", 6-Pack..... #19074.....\$22.95/kit
 All Shop Builder, 56-Pieces..... #19075.....\$179.95/kit



BRAKE HOSE-TO-MOUNTING BRACKET CLIPS
 Set of four.
 1955-57 #019..... \$8.95/set



#16362



#16361

REPLACEMENT REAR DISC BRAKE HOSES
 Replacement hose kits for rear disc conversion kits, rubber or stainless.
 All 16", Rubber w/ 10 mm Banjo Bolt,
 #16362\$49.95/kit
 All 11", Stainless w/ 10 mm Banjo Bolt
 #16361\$72.95/kit



REAR DISC BRAKE CONVERSION BRAKE HOSE
 Use with late model 10-12 bolt rear end conversions.
 1955-57 10-12 Bolt Axle #14309..... \$39.95/ea.



DRUM BRAKE HOSES
 The only difference from the original is the octagonal hose ends. Each car requires two front hoses and one rear hose.
 1955-57 Front..... #028..... \$19.95/ea.
 1955-57 Rear..... #029..... \$25.95/ea.



BRAKE LINE FRAME CLIPS
 1955-57 Inside Frame #1007..... \$29.95/set
 1955-57 Outside Frame (Shown) .. #1008..... \$35.95/set



BRAKE HARDWARE KITS

If you're rebuilding your brakes, these complete kits contain the hardware you need to do the job right. Kits include hold-down springs, adjusters, return springs, and all the related hardware to get those brakes working correctly.

- 1951-58 Front & Rear..... #1512.....\$54.95/kit
- 1951-58 Front..... #1512A.....\$33.95/kit
- 1951-58 Rear..... #1512B.....\$33.95/kit



SELF ADJUSTING BRAKE HARDWARE KITS

Update your brake hardware to this time saving self adjusting kit. One kit per axle required, some drilling may be required.

- 1955-57 Front..... #12249.....\$49.95/kit
- 1955-57 Rear..... #12250.....\$49.95/kit



BRAKE HOLD-DOWN KIT

All the springs and hardware needed to complete an axle set.

- 1955-57 #158..... \$6.50/set



#1506

#1507

BRASS BRAKE JUNCTION BLOCKS

These brake junction blocks are 100% correct reproductions.

- 1955-57 Rear, '53-62 Vette, Rear #1506..... \$16.95/ea.
- 1955 Front, Driver #1507..... \$16.95/ea.
- 1955 Front, Passenger..... #1508..... \$16.95/ea.
- 1956-57 Front, Driver #1509..... \$16.95/ea.
- 1956-57 Front, Passenger..... #1510..... \$16.95/ea.



BRAKE ADJUSTING SCREW SPRINGS

Includes two springs, a one axle set.

- 1955-57 #157..... \$6.95/set



PARKING BRAKE ASSEMBLIES

Each assembly comes completely assembled and includes the mounting bracket with both rollers. Ready to paint and/or install. Parking brake handle is made of steel instead of the original plastic on the #14200 and #14201 and chrome on the #18415 and #18416 .

1955-56	#14200.....	\$149.95/kit
1957.....	#14201.....	\$149.95/kit
1955-56 Chrome Handle (Shown). #18415.....	\$179.95/set	
1957 Chrome Handle	#18416.....	\$179.95/set



EMERGENCY BRAKE WARNING LIGHT KIT

Like the original accessory, this kit provides a flashing red light when the emergency brake is left engaged.

1955-57	#18382.....	\$95.95/kit
----------------------	--------------------	--------------------



UNIVERSAL PARKING BRAKE CABLE MOUNT KITS

These brackets allow repositioning your Emergency brake cable attaching points; perfect for configuring any custom application as well as being used to replace lost or broken originals. Includes hardware.

All.....	#18683.....	\$21.95/kit
-----------------	--------------------	--------------------



STOP LIGHT SWITCH

Mounts under the dash and contacts the front of the brake pedal. Switch is on when plunger is open, off when plunger is depressed. Light switch should be adjusted to come on when brake pedal has been depressed .62-inch from normal or resting position.

1955-57	#116.....	\$21.95/ea.
----------------------	------------------	--------------------



PARKING BRAKE SPREADER BAR

The parking brake spreader installs on the rear drum brakes between the brake shoes.

1955-57	#16833.....	\$9.95/ea.
----------------------	--------------------	-------------------



BRAKE ADJUSTING SCREW

Sold separately. Four needed per car.

1955-57	#159.....	\$8.95/ea.
----------------------	------------------	-------------------



EMERGENCY BRAKE CABLE KITS

Lokar's brake cable kits make it easy to fabricate brake cables when installing non-original rear ends or brake kits. Be sure to order the needed clevis, parts #14821-23, shown below.

All Rear, Universal, Black (Shown)

..... #14819..... \$169.95/kit

All Rear, Universal, Stainless #14820..... \$238.95/kit



LOKAR FLOOR MOUNT EMERGENCY HAND BRAKE BOOTS

Lokar hand brake boots are black neoprene and all sets include a boot, billet aluminum ring with ball-milled edge and stainless screws. Billet aluminum rings also available in black anodized with part #18374.

All Billet..... #18371..... \$69.95/ea.

All Midnight Series Billet #18374..... \$69.95/ea.



LOKAR EMERGENCY BRAKE CABLE KIT, WILWOOD WITH INTERNAL DRUM

All..... #18372..... \$166.95/kit



LOKAR FLOOR MOUNT EMERGENCY HAND BRAKES

Lokar's floor mount emergency hand brake is designed after the automotive industry standard. Ratchet cut gear plate and lock are heat treated for strength and safety. Available in chromed steel or black powder coated steel. Special feature includes 4-point mounting capabilities for floor mount or side mounting for personal applications. Comes complete with clevis for installation with Lokar emergency brake cables. Cables are sold separately. Lever has been designed with durability in mind. Hand brake measures 10-inch from end to end.

All..... #18369..... \$146.95/ea.

All Midnight Series #18373..... \$146.95/ea.



LOKAR EMERGENCY BRAKE CABLE CLEVISES

All Wilwood/88-up Vette Rear Brakes

..... #14821..... \$33.95/pr.

All 84-87 Vette Rear Brakes #14822..... \$45.95/pr.

All Ford Explorer Rear Brakes #14823..... \$45.95/pr.



LOKAR EMERGENCY BRAKE WARNING INDICATOR SWITCH KIT

All..... #18370..... \$43.95/kit



E-STOPP PUSH BUTTON EMERGENCY BRAKE KIT

The E-STOPP® push button emergency brake is the perfect E-brake for custom vehicles and winner of the 2012 NSRA new safety product of the year. It not only frees up room on the chassis and in the cab but doubles as an anti-theft device when the button is hidden. It works with any kind of brake system that can accept an e-brake cable and can mount anywhere on the chassis that you have room. The kit comes with the actuator, the control box w/ switch and wire connectors. After market brake cables are required and sold separately. See Lokar brake cable kits, parts #14819-14820, shown on page 471.

All Standard #18286..... \$478.95/kit



E-STOPP CABLE BRACKET

The E-STOPP optional cable bracket can be used to help route and connect your cables to the E-STOPP Actuator.

All Machined #18288..... \$37.95/ea.



EMERGENCY BRAKE SHOE LEVER

Kit includes brake shoe levers, shoe spreader bars and hardware. One kit does both sides.

1955-57 #17638..... \$44.95/kit



EMERGENCY BRAKE ADJUSTMENT RODS

1955-57 exc. Convertible (Shown) #1570..... \$45.95/ea.
 1955-57 Convertible..... #1571..... \$49.95/ea.



EMERGENCY BRAKE CABLE CLIPS

1955-57 #1504..... \$5.95/set



EMERGENCY BRAKE CABLES

Original rear brake cables used a boot to keep out dirt and debris which is not necessary on our part #293. **Made in the USA.**

1955-57 Front, Best, exc. Convertible.....	#795.....	\$44.95/ea.
1955-57 Front, Good, exc. Convertible	#16789.....	\$18.95/ea.
1955-57 Front Convertible	#795A.....	\$38.95/ea.
1955-57 Rear (Shown)	#293.....	\$69.95/ea.

EMERGENCY BRAKE ROLLERS

Molded nylon rollers to replace those worn or broken originals. Be sure to order #1591 bolts, shown below.



1955-58 & 55-59 Truck..... #1590..... \$9.95/pr.

EMERGENCY BRAKE CLEVIS

Includes clevis, pin, and cotter key. Goes on the end of the cable coming from the emergency brake cable and hooks onto the idler lever, parts #1592 and #1593, shown at left.



1955-57 #1594..... \$19.95/set

EMERGENCY BRAKE ROLLER BOLTS

Use these special machined shoulder bolts in conjunction with our cable rollers to restore your emergency brake system.



1955-58 & 55-59 Truck
..... #1591..... \$4.95/pr.



EMERGENCY BRAKE LINKAGE RETURN SPRINGS

Attaches between the floor bracket and the emergency brake idler lever.

1955-57 exc. Convertible #1486..... \$8.95/ea.
1955-57 Convertible..... #1487..... \$8.95/ea.



PLATED EMERGENCY BRAKE BRACKET SCREWS

1955-57 #2892..... \$3.95/pr.



EMERGENCY BRAKE IDLER LEVERS

These levers connect the front and rear emergency brake cable.

1955-58 exc. Convertible #1592..... \$19.95/ea.
1955-57 Convertible..... #1593..... \$19.95/ea.

EMERGENCY BRAKE FLOOR BRACKETS

These brackets mount under the floor to the center brace and support the emergency brake idler lever.

1955-57 exc. Convertible #16984..... \$79.95/pr.



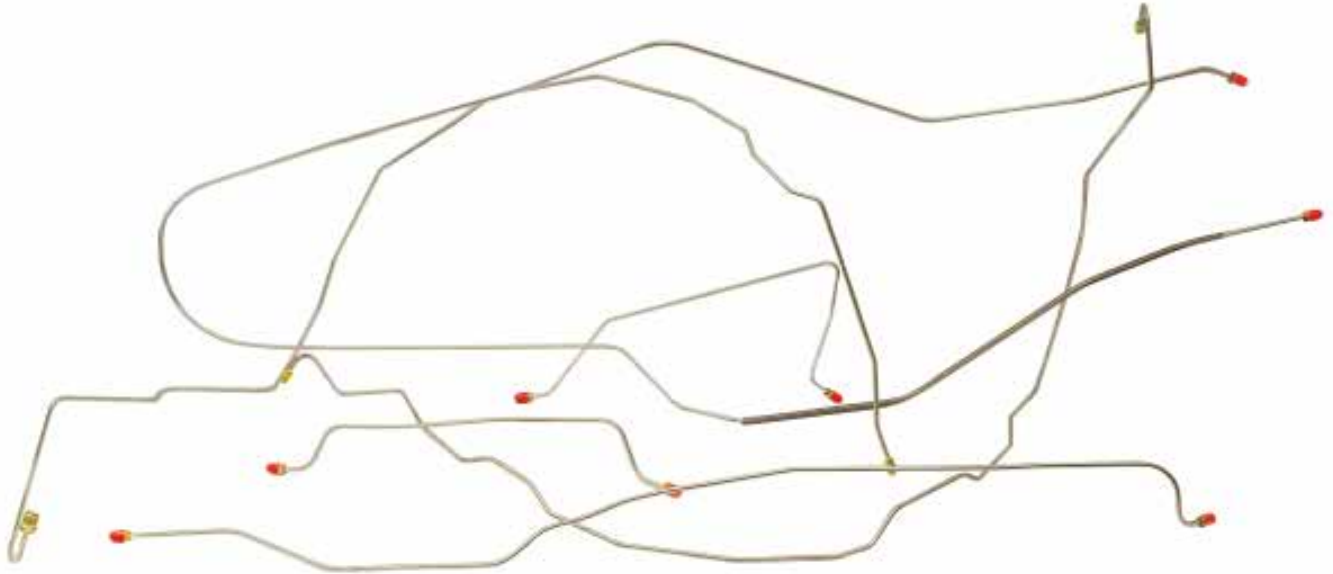

FRONT TO REAR BRAKE LINES FOR DISC BRAKE CONVERSIONS O/S

These kits, available in steel or stainless, cover your braking system from the proportioning valve on your power brake booster to the rear flexible hose and everywhere in between. Front to rear line runs outside the frame.

1955-57 Steel	#10122	\$134.95/set
1955-57 Stainless	#10123	\$179.95/set



BRAKE LINE BRACKET

This bracket will be necessary if you are moving your brake lines to the outside of the frame from the inside of the frame. This supports the line at the rear where it connects to the rear brake hose.

1955-57 4BC, Dual 4BC, Fuel Injection	#1513	\$37.95/ea.
---	--------------------	--------------------

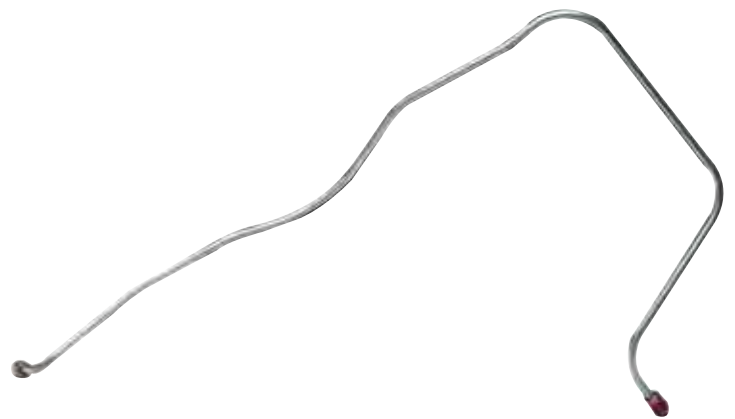

MASTER CYLINDER TO JUNCTION BLOCK BRAKE LINES, NON-POWER

This is the brake line that runs from the master cylinder down to the junction block on the driver side on all non-power applications.

1955	#16259	\$21.95/ea.
1956-57	#16260	\$21.95/ea.

BRAKE LINE CLIP

1955-57 Master Cyl. to Firewall	#11227	\$5.95/ea.
---	---------------------	-------------------



FRONT CROSS MEMBER BRAKE LINE CLIP

1956-57	#18291	\$7.95/pr.
----------------------	---------------------	-------------------



BRAKE LINE AND EXHAUST BRACKET TO FRAME BOLTS

All the bolts you need to attach your brake line junction blocks, brake line bracket and exhaust hanger brackets.

1955-64	#1484	\$9.95/set
----------------------	--------------------	-------------------

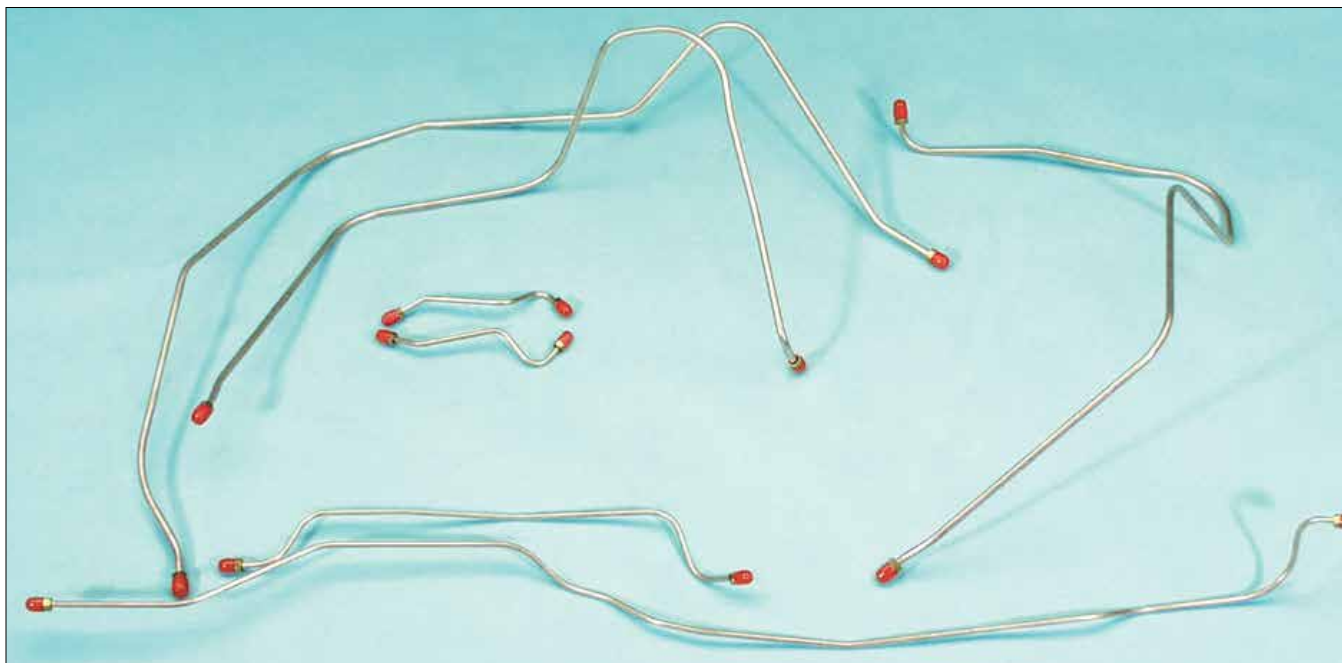

BRAKE LINE SETS

Don't take chances on old, bent brake lines. Our brake lines are reproduced with the original contours and fittings, and include plastic end caps to keep the lines free of moisture and dust until you are ready to install them. Separate front brake line sets were produced for power and non-power systems. Rear brake line sets are common to both systems. **Designed for original front and rear drum brakes.**

1955 Front Set w/out Power	#1464.....	\$58.95/set
1955 Front Set w/ Original Factory Power	#1465.....	\$58.95/set
1956-57 Front Set w/out Power	#1466.....	\$58.95/set
1956-57 Front Set w/ Original Factory Power (Shown)	#1467.....	\$69.95/set
1955-57 Rear Set (Shown).....	#1468.....	\$28.95/set
1955 From Master Cyl. w/ Original Factory Power.....	#1469.....	\$21.95/ea.
1956-57 From Master Cyl. w/ Original Factory Power (Shown)	#1470.....	\$21.95/ea.
1955 6-Cyl., V8 2BC, Inside Frame, Long	#1471.....	\$44.95/ea.
1955 V8 4BC, Outside Frame, Long	#1472.....	\$39.95/ea.
1956-57 6-Cyl., V8 2BC, Inside Frame, Long	#1473.....	\$43.95/ea.
1956-57 V8 4BC, Outside Frame, Long	#1474.....	\$39.95/ea.

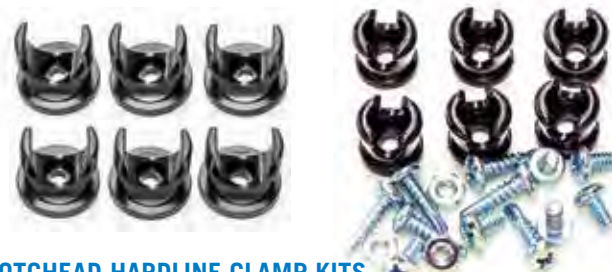
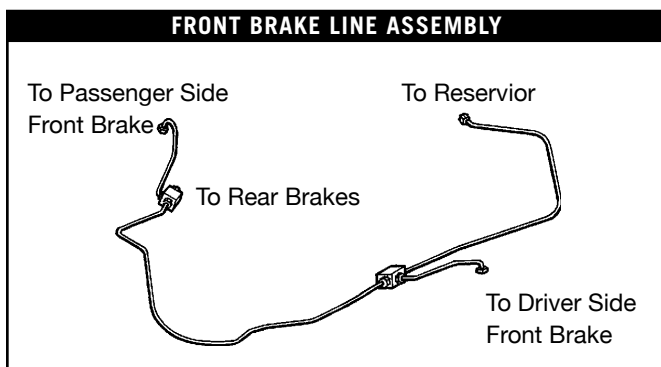

NOTCHEAD HARDLINE CLAMP KITS

All 3/16", 6-Pc.....	#18854.....	\$16.95/kit
All 1/4", 6-Pc.....	#18855.....	\$17.95/kit
All 3/8", 6-Pc.....	#18856.....	\$18.96/kit
All 1/2", 6-Pc.....	#18857.....	\$22.95/kit

NOTCHEAD SOFTLINE CLAMP KITS

All 1/2", Heater/#6 AC, 6-Pc.	#18858.....	\$22.95/kit
All 5/8", Heater/#8 AC, 6-Pc.	#18859.....	\$24.95/kit
All 3/4", Heater/#10 AC, 6-Pc.	#18860.....	\$26.95/kit



1955 FRONT BRAKE LINE CLIP SET

1955.....	#1505.....	\$4.95/set
-----------	------------	------------

WARNING! Products on these pages may contain chemicals known to the State Of California to cause cancer and/or birth defects or reproductive harm. www.p65warnings.ca.gov

ROLLER BEARING CONVERSION KITS

Our conversion kit eliminates the old ball bearings and replaces them with modern roller bearings. Though this is an excellent way to modernize stock wheel applications, it's an absolute must-have for those with custom, non-original wheels. Old-style ball bearings can't withstand the side loads that custom width wheels transmit to the bearing. You can use your stock brake drums and will not notice any changes in front end alignment. Kit comes complete with new hubs, studs, inner bearings, outer bearings, races, grease seals, hub caps, and spindle nut washers. Easy to install. Part #17986 is the same as part #138 except it uses aluminum hubs compared to the cast iron hubs used on the #138.



1955-57 Front, Cast Iron	#138.....	\$259.95/kit
1955-64 Front, Forged Aluminum	#17986.....	\$189.95/kit



REAR AXLE BEARINGS

1955-56	#004.....	\$107.95/ea.
1957 (Shown)	#005.....	\$99.95/ea.



FRONT WHEEL BEARINGS AND OIL SEALS

Outer Bearing:

1955	#001A.....	\$89.95/ea.
1956-57	#001.....	\$59.95/ea.

Inner Bearing:

1955-57	#002.....	\$81.95/ea.
1955-57 Oil Seal, Front Wheel	#003.....	\$15.95/ea.

OE "DISC BRAKE" WHEELS O/S

These OE style disc brake compatible wheels are black powdercoated and use original lug nuts. They accept a small center cap, 10-1/8-inch, that mounts around the center of the wheel as well as the Bel Air full caps. **Check fit before painting. Modified parts cannot be returned. Made in the USA.**

1955-56 15" x 5"	#17704.....	\$167.95/ea.
1955-56 15" x 6"	#17705.....	\$167.95/ea.
1955-56 15" x 7"	#17706.....	\$167.95/ea.
1957 14" x 6".....	#17702.....	\$167.95/ea.
1957 14" x 7".....	#17703.....	\$167.95/ea.



WHEEL COVER SPINNER ASSEMBLY



This complete kit includes four of our beautifully triple chrome-plated wheel spinners, crest emblems and mounting hardware. The spinner assembly is designed to fit 1957-58 Bel Air full size wheel covers. We've also seen these spinners modified to fit other wheel covers. **Made in the USA.**

- 1957-58 Best #578..... \$215.95/set
- 1957-58 Spinner Emblems Only #297..... \$54.95/set



WHEEL COVER SPINNER ASSEMBLY

A very good version of our #578. **Made in the USA.**

- 1957-58 Good #V578..... \$215.95/set



RALLY WHEELS O/S

The rally wheel first appeared in 1968, but it wasn't long before this design became popular among 1955, 1956 and 1957 owners as well. Wheels can be painted to match the color of your car, or even chrome plated. We offer this wheel painted the factory argent silver.

- All 14" x 7" #4464..... \$98.95/ea.
- All 15" x 7" #17645..... \$113.95/ea.
- All 15" x 8" #4465..... \$111.95/ea.



WHEELS FOR USE WITH DISC BRAKES O/S

Accepts full wheel covers and clears disc brakes. Features Chevy and Ford bolt patterns. Hub caps **MUST** be fitted prior to painting.

- 1955-56 15" x 5" #12146..... \$134.95/ea.
- 1957 14" x 6" #12148..... \$129.95/ea.



RALLY WHEEL CENTER CAP 1956 STYLE
All #17649..... \$39.95/ea.



STAINLESS RALLY WHEEL TRIM RINGS
All 14" x 7" #17642..... \$42.95/ea.
All 15" x 7" #17643..... \$42.95/ea.
All 15" x 8" #17644..... \$42.95/ea.



RALLY WHEEL CENTER FLAT CAP
All Stainless #17647..... \$29.95/ea.



RALLY WHEEL CENTER DERBY CAP
All Stainless #17648..... \$51.95/ea.



RALLY WHEEL POLICE CAP WITH BOWTIE
All Stainless #17646..... \$41.95/ea.



1955 SHOW QUALITY GREASE HUB CAPS
1955..... #2185..... \$24.95/pr.



GREASE HUB CAP
Replace those old, dented caps with this original design part.
1956-57 #031..... \$19.95/ea.



WHEEL LUG NUT
Five lug nuts required per wheel.
1955-57 7/16-20 #155..... \$1.95/ea.



WHEEL LUG STUD
Sold individually; Five required per wheel.
1955-57 #154..... \$2.95/ea.



BEL AIR WHEEL COVERS

These replacement wheel covers fit and look like the originals, except for the center crest. They are chrome over stainless and fit original style wheels.

1955.....	#1128.....	\$134.95/ea.
1956 Full	#15559.....	\$131.95/ea.
1957 Full w/o Crest	#15560.....	\$130.95/ea.



150 AND 210 WHEEL COVERS

These gems are available once again. Cannot be used with replacement steel wheels, parts #12146-#12148, sold separately.

1955.....	#1136.....	\$84.95/ea.
1956.....	#1137.....	\$84.95/ea.
1957 w/o Crest.....	#15561.....	\$71.95/ea.



1956 WIRE WHEEL COVER

Add some sparkle to your car with these stylish, stainless steel wire wheel covers. Mounting clips included.

1956.....	#2086.....	\$155.95/ea.
-----------	------------	--------------



1956 WIRE WHEEL HUBCAP RETAINER CLIPS

1956 1-Wheel	#15686.....	\$29.95/set
1956 4-Wheel	#15687	\$99.95/set

BEL AIR HUBCAP DECALS



If you're sporting polished stainless steel hubcaps, you need these. Easier to apply than paint, our hubcap decals are essential to the well-detailed auto. Each decal sheet is made of quality adhesive-backed vinyl. One sheet needed per hubcap.



Made in the USA. 

1955 White	#963.....	\$10.95/ea.
1956 Black (Shown)	#964.....	\$10.95/ea.
1957 Black	#610.....	\$9.95/ea.



TORQ-THRUST RIMS O/S

If these don't bring back memories of "Hot Rodding" in the 60's and 70's we don't know what will. These American-made Torq-Thrust rims are top quality replicas of the originals. If you're looking for a little extra shine, try the 2-piece polished versions. Includes standard center cap. 15-inch x 7-inch wheels have a backspacing of 3-3/4-inch, 16-inch x 7-inch and 17-inch x 7-inch wheels have backspacing of 4-inch and 16-inch x 8-inch and 17-inch x 8-inch have a 4-3/4-inch backspacing. Installation kit sold separately.

All 15" x 7", "D", Gray.....	#10219.....	\$224.95/ea.
All 15" x 7", "D", Chrome	#13055.....	\$311.95/ea.
All 15" x 7", "II", Polished	#10220.....	\$295.95/ea.
All 16" x 7", "II", Polished	#13056.....	\$300.95/ea.
All 16" x 8", "II", Polished (Shown)	#13057.....	\$389.95/ea.
All 17" x 7", "II", Polished	#14567.....	\$318.95/ea.
All 17" x 8", "II", Polished	#14568.....	\$349.95/ea.
All 15" x 7", Original (T.T.O.), Polished.....	#13054.....	\$259.95/ea.



AMERICAN RACING OAKLAND TORQ-THRUST CENTER CAPS

Caps fit Torq Thrust, Salt Flat and Hopster rims.
All..... #13053..... \$364.95/set



AMERICAN RACING TORQ-THRUST II SHORT CENTER CAP

Caps fit Torq Thrust, Salt Flat and Hopster rims.
All..... #13052..... \$19.95/ea.



CRAGAR GT WHEELS O/S

Cragar Vintage GT wheels are a one-piece cast design with a 5-spoke center and the Cragar Logo cast into the lip face. Available in chrome or with a grey spoke and machined lip, these wheels are drilled to be used with a conical lug nut. Center cap included, lug nuts sold separately.

All 15" x 7", Chrome	#18583.....	\$320.95/ea.	All 18" x 7", Chrome	#18587.....	\$288.95/ea.
All 15" x 8", Chrome	#18584.....	\$349.95/ea.	All 15" x 7", Grey	#18589.....	\$163.95/ea.
All 17" x 7", Chrome	#18585.....	\$324.95/ea.	All 15" x 8", Grey	#18590.....	\$169.95/ea.
All 17" x 8", Chrome	#18586.....	\$359.95/ea.	All 17" x 7", Grey	#18591.....	\$208.95/ea.



CRAGAR "SS" WHEELS O/S

All 15" x 6", 3-1/4" Backspace	#18506.....	\$224.95/ea.
All 15" x 7", 4" Backspace	#18507.....	\$243.95/ea.
All 15" x 8", 4-1/4" Backspace	#18508.....	\$246.95/ea.
All 17" x 7", 3-3/4" Backspace	#18509.....	\$319.95/ea.
All 17" x 8", 4-1/2" Backspace	#18510.....	\$319.95/ea.
All 17" x 9", 5-1/2" Backspace	#18511.....	\$329.95/ea.

CRAGAR SS TRI-CAR SPINNER WHEEL CENTER CAPS

One of the most popular mods on Cragar wheels is this Tri-Bar bolt on center cap that replaces the originals. Chrome plated aluminum these will take your wheels and your classic up to a new level.

All.....	#19004.....	\$76.95/pr.
----------	-------------	-------------



CRAGAR "SS" CENTER CAP

All.....	#18512.....	\$21.95/ea.
----------	-------------	-------------



AMERICAN LEGEND CRUISER WHEELS O/S

Includes chrome lug nuts and center caps.

All 17" x 7", Argent Silver	#18469.....	\$179.95/ea.
All 17" x 7", Polished.....	#18470.....	\$179.95/ea.
All 17" x 8", Argent Silver	#18471.....	\$179.95/ea.
All 17" x 8", Polished.....	#18472.....	\$179.95/ea.
All 18" x 7", Argent Silver	#18473.....	\$204.95/ea.
All 18" x 8", Argent Silver	#18475.....	\$204.95/ea.
All 18" x 8", Polished.....	#18476.....	\$204.95/ea.



AMERICAN LEGEND STREETER WHEELS O/S

American Legend Streeters, with their beautiful deep-machined lips, are some of the best looking and fitting rims around. They clear most brake upgrades and are available with the traditional polished center. 4.75-inch backspacing is available for #16209 and #16211 by special order. Includes chrome lug nuts and center caps.



These sizes have a 4.25-inch backspacing.

All 17 x 7, Polished	#16208.....	\$189.95/ea.
All 18 x 7, Polished	#16210.....	\$205.95/ea.

These sizes have a 4.5-inch backspacing.

All 17 x 8, Polished	#16209.....	\$189.95/ea.
All 18 x 8, Polished	#16211.....	\$209.95/ea.

These sizes have a 5.25-inch backspacing.

All 18 x 9, Polished	#16368.....	\$254.95/ea.
All 20 x 8.5, Polished	#16369.....	\$254.95/ea.

These sizes have a 5.5-inch backspacing and includes chrome lug nuts and center cap.

All Polished, 20 x 10	#16370.....	\$259.95/ea.
-----------------------------	-------------	--------------



AMERICAN LEGEND RACER WHEELS O/S

Rugged, durable, pressure cast 1-piece construction and detailed finish makes American Legend "Racer" wheels an excellent value for the money. Modeled after the early Halibrand wheels these have the same classic styling but in larger diameters and widths. Available with centers painted in light gray or beautifully polished these are the perfect upgrade to your current wheels. American Legend wheels are precision engineered and manufactured to meet USA, SAE and Australian standards. 4.5-inch backspacing. Includes chrome lug nuts and center caps.

All 17" x 7", Polished.....	#18478.....	\$183.95/ea.
All 17" x 8", Polished.....	#18480.....	\$183.95/ea.
All 18" x 7", Polished.....	#18482.....	\$215.95/ea.
All 18" x 8", Polished.....	#18909.....	\$215.95/ea.
All 18" x 9", Polished.....	#19039.....	\$215.95/ea.
All 17" x 7", Light Gray.....	#18477.....	\$183.95/ea.
All 17" x 8", Light Gray.....	#18479.....	\$183.95/ea.
All 18" x 7", Light Gray.....	#18481.....	\$215.95/ea.
All 18" x 8", Light Gray.....	#19037.....	\$215.95/ea.
All 18" x 9", Light Gray.....	#19038.....	\$215.95/ea.



CHROME VALVE STEMS

All Set of 4..... #18990..... \$6.95/set



CHROME WHEEL LOCK SET

All 7/16"..... #13048..... \$29.95/set



CHROME LUG NUT

All 7/16", Acorn..... #13049..... \$1.95/ea.



CHROME WHEEL INSTALLATION KIT

All 7/16", Acorn..... #13047A..... \$36.95/kit



B.F. GOODRICH SILVERTOWN WHITEWALL RADIAL TIRES O/S

If it's a classic look with a great ride you're after then these radials are your answer. The beautiful 2-3/8-inch white walls will class-up your classic and compliment your show car. Just like your modern day car these radials feel like heaven on the pavement. The 1955-56 application is sized 205/75R15 and replaces the 6:70-15. The 1957 application is sized 205/75R14 and replaces the 7:50-14.

1955-56 #872 \$279.95/ea.
 1957 #873 \$279.95/ea.

RADIAL WHITEWALL TIRES WITH BIAS PLY LOOK O/S



Coker Tire's new American Classic radials are **Made in the USA** and thoroughly tested to ensure superb quality for your collector vehicle. You can trust that American Classic radials are ready for the road, but they're also ready for the show field with beautiful styling whitewall that is built in to the tire from day one. The true whitewall construction, along with the "pie crust" shoulder and vintage-style tread pattern give this tire the original look, while the radial internals make it the perfect choice for a car that will see plenty of miles. **Made in the USA.**

1955-56 670/R15, 2-3/4" WW #17881 \$279.95/ea.
 1957 750/R14, 2-1/4" WW #17882 \$289.95/ea.



B.F. GOODRICH WHITEWALL TIRES O/S

If you don't own a set of these beautiful tires, you are missing out. These genuine B.F. Goodrich whitewall tires are the most original and highest quality we can offer. Next time you need new tires or are just looking to upgrade, you can't go wrong with these babies.

1955-56 6:70 x 15, 2-1/2" Whitewall #740 \$209.95/ea.
 1957 7:50 x 14, 2-1/4" Whitewall #741 \$209.95/ea.

COKER TIRE WARRANTY INFORMATION

Coker Tire guarantees their tires to be free from defects in workmanship and materials for the life of the tread. Adjustment is made on a prorated basis (you pay for the tread used). In some cases tread wear is not an issue. The tires get old and start to crack due to age. Any judgements made regarding a guarantee in this situation is at the sole discretion of Coker Tire based on your purchase date, so be sure to keep your receipt. They are not responsible for tire and tube failure due to improper mounting, mechanical failure or improper alignment of the vehicle. Coker Tire does not offer any guarantee of fitment for any particular purpose and limits its liability to the purchase price of the item. All tires and tubes should be installed by properly trained individuals. Dimensions for tires listed are not scientifically measured and may vary depending on rim widths and inflation. Warranty returns require an RMA number and a valid purchase receipt. **ALL WARRANTIES ARE HANDLED BY COKER TIRE DIRECTLY.** Danchuk does not handle or offer any warranties on tires.

11. Engine & Trans.

SECTION AT A GLANCE:

Engines & Related	486
Motor Mount	490
Engine Dipsticks.....	493
Timing Chain.....	495
Milodon	496
Oil Pan Related	498
Oil Filter	499
Balancers	500
Crankshaft Pulleys	501
Belts & Pulleys.....	502
Water Pump Pulleys.....	503
Water Pumps.....	504
Pulleys & Brackets.....	505
Bill's Hot Rod Brackets	506
Pulley Systems	508
Transmission Mounts	510
Cross Members.....	512
Transmissions.....	513
MSD Controllers	514
Torque Convertor.....	515
Transmission Pans	516
Oil Cooler.....	517
Transmission Dipsticks.....	520
Speedometer.....	522
Shift Linkage	523
Clutch Related	524
Shifters	528
Throttle Cables.....	530
Kickdown.....	531
Neutral Safety Switch	532



EDELBRUCK PERFORMER 350 ENGINES

These 9.0:1 compression engines have 320 HP and 382 ft/lbs of torque. Custom assembled by Edelbrock technicians, they include the Edelbrock Performer EPS manifold, 600 CFM carb with electric choke, aluminum heads with guide plates, aluminum valve covers with a custom badge, cast iron crank, cast aluminum pistons and powdered metal rods. They are covered by Edelbrock's 24-month unlimited mileage, zero deductible warranty.

All 320 HP/382 Torque, Cast..... #13205... \$6863.95/ea.

All 320 HP/382 Torque, Polished Package (Shown)

..... #13206... \$7293.95/ea.



EDELBRUCK PERFORMER HI-TORQUE 350 ENGINE

Available with a 650 CFM carb, you are assured to get Edelbrock's proven performance and reliability. We offer these in the Endurashine finish for the ultimate in visual impact.

All 363 HP/405 Torque, Single Carb, Endurashine

..... #15138... \$7878.95/ea.



EDELBRUCK PERFORMER RPM E-TEC 350 ENGINES

The 9.5:1 compression engines have 435 HP and 435 ft/lbs of torque. Custom assembled by Edelbrock technicians, they include the Edelbrock RPM Air Gap manifold, 800 CFM carb with electric choke, E-Tec heads with guide plates, aluminum valve covers with a custom badge, forged steel crank, hypereutectic pistons, powdered metal rods and Milodon oil pan. They are covered by Edelbrock's 24-month unlimited mileage, zero deductible warranty.

All 435 HP/435 Torque, Cast..... #13209... \$8445.95/ea.

All 435 HP/435 Torque, Polished Package

..... #13210... \$8663.95/ea.



EDELBRUCK PERFORMER RPM 350 ENGINES

These 9.5:1 compression engines have 410 HP and 408 ft/lbs of torque. Custom assembled by Edelbrock technicians, they include the Edelbrock RPM Air Gap manifold, 800 CFM carb with electric choke, aluminum heads with guide plates, aluminum valve covers with a custom badge, forged steel crank, hypereutectic pistons, powdered metal rods and Milodon oil pan. They are covered by Edelbrock's 24-month unlimited mileage, zero deductible warranty.

All 410 HP/408 Torque, Cast..... #13207... \$8564.95/ea.

All 410 HP/408 Torque, Polished Package

..... #13208... \$9016.25/ea.

**EDELBROCK/MUSI 555
BIG BLOCK ENGINES**

Edelbrock/Musi 555 crate engines are a powerful big cubic inch package that features the all new Edelbrock E-CNC cylinder heads for the ultimate in Edelbrock performance. E-CNC cylinder heads are fully CNC ported to achieve optimal air-flow for maximum horsepower and torque in high performance street and light duty racing applications. They feature exhaust port exits in the stock location, which allows for the use of off-the-shelf headers. Each engine is assembled by 8-time Pro Street World Champ Pat Musi. They deliver maximum hp and torque on 91 octane fuel. Comes complete with a #2902 Victor Jr. intake, Rolling Thunder #2264 hydraulic roller camshaft, Pro-Flo 2 Electronic Fuel Injection, E-CNC # 79555 cylinder heads and cast aluminum valve covers. Available carbureted or with Pro-Flow 2 EFI.



All Carbureted, 676HP	#18778	\$16674.95/ea.
All Fuel Injection, 697 HP	#18779	\$15808.95/ea.



EDELBROCK PERFORMER 350 V8 ENGINE

This is an affordably priced, entry level small-block Chevy crate engine for any street rod or muscle car driver on a budget that wants affordable 300+ horsepower performance on 87-octane fuel. Edelbrock E-Street crate engines start out with a 100% brand new GM short-block with 4-bolt main and 2-piece rear main seal. This new crate engine features black powder coated intake manifold, carburetor, valve covers and breathers, E-Street cylinder heads, Performer Series carburetor, Performer EPS intake manifold, Performer Series camshaft and quality distributor. E-Street heads are designed for high performance street applications and feature larger than stock intake and exhaust ports to improve engine efficiency. Sold without a water pump.

All 315 HP/381 Torque	#17231 ...	\$6552.95/ea.
------------------------------------	-------------------	----------------------



EDELBROCK PERFORMER 350 ENGINES

These 8.5:1 compression engines have 310 HP and 375 ft. lbs. of torque. Custom assembled by Edelbrock technicians, they include the Edelbrock Performer EPS manifold, 600 CFM carb with electric choke, aluminum heads with guide plates, Elite Series valve covers with a custom badge, cast iron crank, cast aluminum pistons and powered metal rods. They are covered by Edelbrock's 24-month unlimited mileage, zero deductible warranty.

All 310 HP/375 Torque, Cast..... #13203... \$6850.95/ea.

**All 310 HP/375 Torque, Polished Package
..... #13204... \$7281.95/ea.**



GM FLEXPLATE FOR EDELBROCK CRATE ENGINES

This Chevrolet Performance flexplate is an externally balanced unit with a 168-tooth ring gear and a dual 10.75/11.50 inch blot pattern for use with 86-up small blocks with a 1-piece rear main seal. GM #14088761. Not SFI approved.

1986-Up #14261..... \$154.95/ea.



TCI FLEXPLATE

TCI forged flexplates are .035-inch thicker than stock and the starter ring is welded on both sides for added strength. This is a 168 tooth, internally balanced, dual bolt patterned unit with dual GM bolt patterns sized for stock 3/8-inch mounting bolts, but they can be drilled out to 7/16-inch if needed. For use with Chevy V8 engines with a two piece rear main seal. SFI approved. Will not work with cast iron Powerglides or any 6-cylinder applications.

**All 168 Tooth, Internal Balance, Dual Bolt Pattern,
All Chevy V8..... #13023..... \$99.95/ea.**



ARP FLEXPLATE BOLT KITS

ARP Pro Series flexplate bolts are far superior to OEM hardware. Forged from aerospace alloy and heat-treated prior to thread rolling and machining, they feature an exclusive, flat 12-point head design and a larger-than-stock shank diameter for increased strength and improved register.

All SB/BB w/ 2-Piece Rear Seal #18764.....\$22.95/kit

All SB/BB w/ 1-Piece Rear Seal #18765.....\$22.95/kit

All Gen 3/4 LS #18766.....\$36.95/kit

All Gen 3/4 LS w/ TH350/400, 700R4 or 200-4R

..... #18767.....\$39.95/kit

All Gen 5 6.2L LT1 #18768.....\$47.95/kit



EDELBRÖCK TOP END KITS

The Edelbrock Power Package top end kits are dyno matched kits all in one box. Just about everything you need to top off your small or big block Chevy.

1957-87 SB, E-STREET, 315 HP/381 Torque	#18466.....	\$1627.95/kit
1957-87 SB, RPM 410 HP/408 Torque (Shown)	#18467.....	\$2266.95/kit
1965-95 BB, RPM 540 HP/539 Torque	#18468.....	\$2901.95/kit



ARP STAINLESS ENGINE AND ACCESSORY FASTENER KITS

Kits include bolts for intake, oil pan, valve covers, thermostat housing, headers, timing cover, distributor, water pump, fuel pump, and side motor mounts. '87 & newer engines require additional fasteners.

All SB, Hex.....	#13989.....	\$194.95/set
All SB, 12-Pt.	#13990.....	\$194.95/set
All BB, Hex.....	#13991.....	\$214.95/set
All BB, 12-Pt.	#13992.....	\$219.95/set



ENGINE INSTALL KITS

These kits works with all Vortec and most LS engines except LS7. They may not work with LSX heads, and dry sump oil systems. Kits include oil pan, windage tray, oil pick up tube, engine side mount adapters, transmission crossmembers, transmission pads and Fit Rite engine mount adapters and all the mounting hardware. Part #19408 includes cast exhaust manifolds with headpipes, while part #19409 includes headers.

1955-57 Manifolds w/Headpipes	#19408.....	\$799.95/kit
1955-57 Headers (Shown)	#19409.....	\$1249.95/kit

MOTOR MOUNTS



MOTOR MOUNT CONVERSION BRACKETS

For installing an LS1 or LS6 engine into a vehicle that is set up for a Chevy small block V8. Part #16546 is a 1-inch setback LS conversion to move your LS motor 1-inch closer to the firewall, which may be required for additional oil pan and header clearance.

All	#12524*\$67.95/pr.
All w/ 1" Set Back	#16546\$85.95/pr.

*Note: For use with Parts #871 and #976 shown on page 491.



MOTOR MOUNT KITS

Kit includes motor mounts, conversion brackets and hardware. Welding required.

1955-57 3/4" Forward	#12184.....	\$179.95/kit
1955-57 Standard	#12185.....	\$179.95/kit



ADJUSTABLE LS ENGINE ADAPTER BRACKETS

These universal adjustable adapter kits allow the engine to move from 1/2-inch rearward (great for oil pan to cross-member clearance) up to 2-1/2-inch forward allowing for a completely custom range of positions. The exclusive design no-weld brackets are CNC laser cut steel and features a durable black powder coat finish. Available with rubber or poly mounts.

1955-57 w/ Poly Mounts (Shown)	#17758.....	\$139.95/pr.
1955-57 w/ Rubber Mounts	#17759.....	\$119.95/pr.

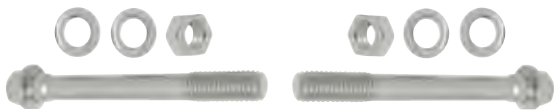

ARP STAINLESS V8 MOTOR MOUNT BOLTS

All Hex Mount to Block	#14021.....	\$23.95/set
All Hex Head to Bracket Bolt	#14022.....	\$23.95/set



MOTOR MOUNT-TO-ENGINE BRACKETS

For stock mount applications use with part #198.
1955-57 V8 Driver..... #251..... \$17.95/ea.
1955-57 V8 Passenger..... #250..... \$17.95/ea.

SIDE MOTOR MOUNT

This side motor mount is for use on all 1958 and later small or big block engines in conjunction with the engine side mount conversion kit, part #871. Mounts on either side of the engine. Two required per car. Sold individually.



1955-57 #976..... \$14.95/ea.



ORIGINAL MOTOR MOUNT SET

Set includes rubbers, washer, and shaft; all parts you need to replace one side. Two sets needed per car.

Made in the USA.

1955-57 V8, 6-Cyl..... #198..... \$38.95/set

MOTOR MOUNT RUBBER CUSHIONS

If your motor mount hardware is in good shape but your rubber mounts are shot, this is the solution for you. Set of four cushions replaces one side. Two sets needed per car. **Made in the USA.**

1955-57 V8, 6-Cyl..... #198A..... \$18.95/set



POLYURETHANE MOTOR MOUNT CUSHIONS

1955-57 Both Sides..... #14225..... \$31.95/set

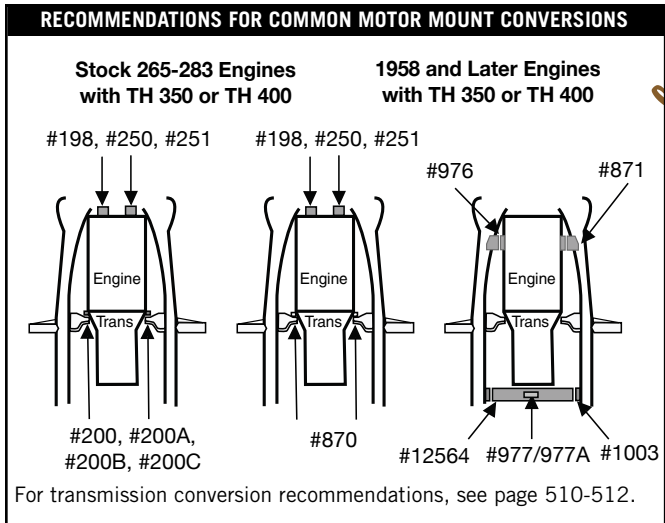

ENGINE SIDE MOUNT CONVERSION KIT

Race-proven and time-tested, this conversion kit is the best way to add modern motor mount strength to 1958 and later small and big block engines. Brackets



are easily welded to the frame, and side motor mounts (part #976 shown at left) are bolted to the block. Please verify frame style before ordering. Part #871 comes with motor mount to bracket bolt only.

1955-57 Seamed Frame, SB, Stock Location

..... #871..... \$69.95/kit



SIDE MOUNT CONVERSION KITS

These updated versions of our #871 series motor mount kits are a true bolt-in kit. Save time and guesswork when converting to side mount and be able to do it with hand tools. Utilizes two of the rivet points in crossmember mounts to mount/locate the brackets to help insure proper placement every time. Fits all frame styles, seamed and seamless.

1955-57 SB, All Frames..... #17756..... \$65.95/kit

1955-57 SB/BB, All Frames, 3/4" (Shown)

..... #17757..... \$65.95/kit

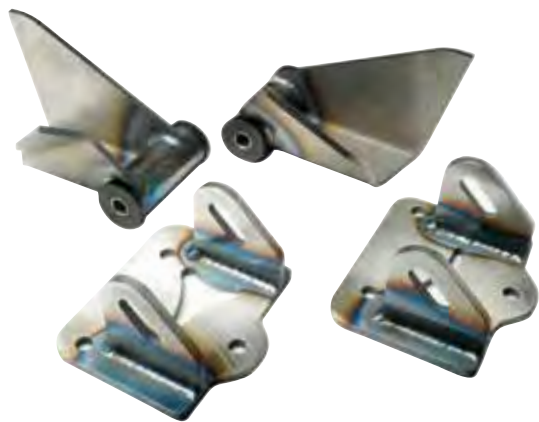

WELD-IN STYLE MOTOR SIDE MOUNT CONVERSION KITS

This design fits both small block (stock and 3/4" forward) and big block engines. Kit includes all the parts to complete the conversion. Welding required.

- 1955-57 SB/BB #16339.....\$274.95/kit
- 1955-57 LS..... #16339A.....\$307.95/kit



POLYURETHANE SIDE MOTOR MOUNTS

Fits with 1955-57 side mount. Polyurethane mounts offer the best of both worlds, smooth running for the street, yet strong enough for the track. Motor mounts also feature safety interlock. Your transmission mount should be the same type as the motor mounts. For a urethane transmission mount that fits autos and standard be sure to order part #15047 or #15048.

- All Zinc #12815..... \$47.95/ea.
- All Chrome #12816..... \$67.95/ea.

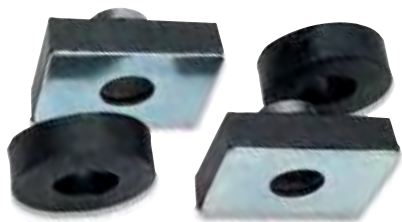

CAB MOUNTS

- 1955-57 Rear Only (Truck)..... #1CAB..... \$27.95/set

BILLET SPECIALTIES MOTOR MOUNT PLATES

Billet Specialties LS Motor Swap Mounts make it easy to put an LS motor in your classic. Multiple mount points allow the bell housing to be located in the same position as the small block in the frame as well as increments of 1/2-inch, 1-3/4-inch and 2-1/4-inch forward for more firewall clearance if needed. Precision machined from 6061-T6 aluminum for strength.



- 1955-57 LS Adj, Black..... #19368.....\$59.95/pr.



ENERGY SUSPENSION LSX MOTOR MOUNT CONVERSION KITS

This set of conversion plates is just what you need if you are installing an LS series engine in your classic Chevy, or any situation where the car is set up to use a standard three bolt motor mount. This set includes two of Energy Suspension's superior Hyperflex polyurethane mounts, adapter plates and all necessary hardware for installation.

- 1955-57 Gold w/ Polyurethane Mounts #16265.....\$135.95/kit
- 1955-57 Chrome w/ Polyurethane #16266.....\$220.95/kit



MOTOR LIFT PLATE FOR LS MOTORS

Bolts in place of the valley cover and includes the mounting bolts and lifting pin-bolt.

- All..... #16545 \$74.95/ea.





#16289

#16290

#16291

#11270

#16290

#16291

#16292

#16293

LOKAR HI-TECH ENGINE DIPSTICKS

1980 & Later SB, Black	#16289.....	\$83.95/ea.
1979 & Earlier SB, Black	#16290.....	\$83.95/ea.
All BB exc. 502, Black	#16291.....	\$83.95/ea.
All 502 BB, Black	#16292.....	\$83.95/ea.
All LSX, Black.....	#16293.....	\$83.95/ea.

LOKAR FLEXIBLE ENGINE DIPSTICKS

Flexible engine dipstick designed with machined aluminum handle to coordinate with Lokar's flexible transmission dipstick. Slim design allows mounting inside headers. Designed for use with factory cast manifolds. E-Z read stainless stick for accurate measure of the engine oil.

1980 & Later SB, Silver	#11271.....	\$75.95/ea.
1979 & Earlier, Silver	#11272.....	\$75.95/ea.
All BB exc. 502, Silver.....	#11273.....	\$75.95/ea.
All 502 BB, Silver	#11274.....	\$75.95/ea.
All LSX, Silver	#15070.....	\$75.95/ea.
1979 & Earlier SB, Dipstick ONLY	#11270.....	\$36.95/ea.





#15077

LOKAR ANCHOR-TIGHT LOCKING ENGINE DIPSTICKS

- 1979 & Earlier SB, Silver..... #15077..... \$109.95/ea.
- 1980 & Later SB, Silver..... #15073..... \$109.95/ea.
- All BB exc. 502, Silver..... #15081..... \$109.95/ea.

- All 502 BB, Silver..... #15085..... \$109.95/ea.
- All LSX, Silver..... #15089..... \$109.95/ea.
- All SB RamJet /Vortec, Silver..... #15093..... \$109.95/ea.

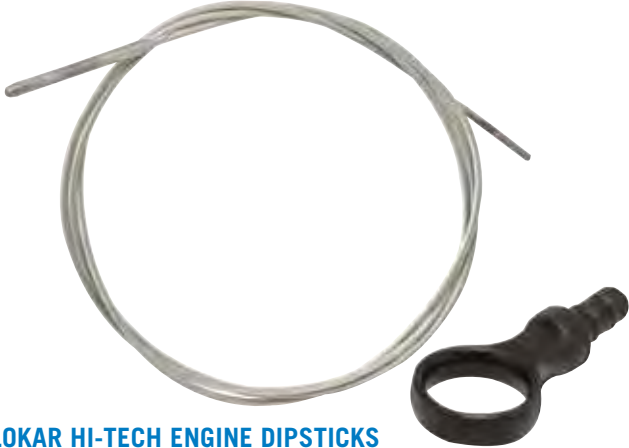

LOKAR HI-TECH ENGINE DIPSTICKS

Lokars "Gauge-to-fit" Dipstick for LS engines is a simple upgrade over the factory plastic handled that not only looks out of place, but can be easily broken. Just use your factory dipstick to measure against and trim the excess and install the billet handle. Available in polished or black.

- All LS1, Polished..... #18280..... \$39.95/ea.
- All LS1, Black..... #18281..... \$39.95/ea.



CHROME DIPSTICKS

Kits consist of both the stick and the tube. Dipstick has the original hook handle. Some modification may be required for trans dipsticks, parts #1977 and 1978.

- 1958-77 SB..... #1975..... \$7.95/ea.
- 1965-91 BB..... #1976..... \$12.95/ea.
- All TH350 (Shown)..... #1977..... \$11.95/ea.
- All TH400..... #1978..... \$11.95/ea.



DIPSTICKS AND TUBES

- 1956-57 Dipstick, V8 & 56-57 Vette 2nd Design..... #10130..... \$18.95/ea.
- 1957-59 Lower Tube, V8..... #10131..... \$21.95/ea.
- 1956-57 Upper Tube, V8..... #10132..... \$13.95/ea.

MILODON ENGINE DIPSTICKS



These engine dipsticks have a unique sleek design. The fittings, stick and hose are all stainless steel and the O-ring sealed handle is billet stainless as well, so they stay bright and rust free even with daily use. **Made in the USA.**



- 1955-79 SB..... #12797..... \$64.95/ea.
- 1986-Up SB..... #12798..... \$64.95/ea.
- All BB..... #12799..... \$69.95/ea.
- All LS1 & LS7..... #14630..... \$69.95/ea.



1955 OIL DIPSTICK TUBE

The 55 V8 block requires this unique, one year only, dipstick tube.

- 1955 V8, Upper Tube..... #13191..... \$13.95/ea.



TIMING CHAIN COVER INSTALLATION KITS

- All SB..... #13393..... \$15.95/kit
- All BB..... #13394..... \$19.95/kit

TIMING TABS

Chrome plated for a perfect match to the timing chain cover.
Note: Parts #1972 and #1974 may be used for some pre-1969 engines by relocating the top dead center on the balancer.



- 1969-91 SB w/ 6-3/4" or 7" Balancer..... #1972..... \$5.95/ea.
- 1969-91 BB w/ 8" Balancer..... #1973 \$4.95/ea.



POLISHED BILLET TIMING CHAIN COVER

- All SB..... #12509..... \$29.95/ea.



MILODON TIMING CHAIN COVER

- All SB w/ Reinforced Thrust Plate..... #13392..... \$33.95/ea.

TIMING CHAIN COVERS

Produced according to GM standards for reliable installation.
 1969-91 SB #1968..... \$26.95/ea.
 1965-91 BB #1969..... \$11.95/ea.



MILODON TIMING COVER BOLTS

- All Front, V8 #13385..... \$5.95/set



TIMING CHAIN SETS

Performer link timing sets, made by Cloyes, are for use with Edelbrock or stock cams except factory roller cams. True roller timing sets have three keyway settings to ensure accurate timing.



- All SB..... #13150..... \$54.95/set
- All BB..... #13151..... \$55.95/set

MILODON SMALL BLOCK TIMING COVERS

Milodons front timing covers are precision checked for proper placement of seal and dowl pins to avoid leaks. Be sure to order the timing cover installation kits for proper installation.



- All SB, Chrome #16919..... \$17.95/ea.
- All BB, Chrome #16920..... \$28.95/ea.
- All BB, Gold #16921..... \$33.95/ea.



ARP STAINLESS TIMING CHAIN COVER BOLTS

- All Hex, V8 #14011..... \$27.95/set
- All 12-Pt., V8 #14012..... \$28.95/set



OE TIMING COVER SCREWS AND WASHERS

- 1955-57 V8 #1537..... \$8.95/set



#12768



#16996

MILODON

MILODON OIL PANS

Milodon oil pans are designed for street performance and dragstrip applications and will clear stock chassis and steering as well as rack-and-pinion. They clear most header styles. These well engineered pans free up additional horsepower through better oil control which is necessary when high volume oil pumps and high RPM ranges are used. Be sure to order the correct pump, pump pick-up and pan gasket for your application. Low profile gives adequate oil supply and maximum available ground clearance. Will not fit '55 V8's. Parts #12768 and #12769 will work with 1955-57 vehicles with big block engines installed.

Pan Profiles:

#12765-67 Street performance pans offer stock appearance, but with an internal mounted windage tray for better oil control and increased horsepower.

#12768-69 Extra low profile designed specifically for 1955-57 big blocks conversions. Offers adequate clearance even if the motor is moved/forward.

- 1956-1979 SB, Low Profile, 8-1/4", 7-Quart #12762..... \$199.95/ea.
- 1980-85 SB, Low Profile, 8-1/4", 7-Quart #12763..... \$219.95/ea.
- 1986-Up SB, Low Profile, 8-1/4", 7-Quart #12764..... \$219.95/ea.
- 1956-79 SB, Street Performance, 7-1/2", 5-Quart #12765..... \$199.95/ea.
- 1980-85 SB, Street Performance, 7-1/2", 5-Quart #12766..... \$199.95/ea.
- 1986-Up SB, Street Performance, 7-1/2", 5-Quart #12767..... \$199.95/ea.
- 1965-90 BB, 8-1/2", 7-Quart #12768..... \$309.95/ea.
- 1991 BB, 8-1/2", 7-Quart..... #12769..... \$369.95/ea.
- All LS1-LS7, 6" Deep, 7-Quart #14627..... \$369.95/ea.

MILODON OIL FILTER RELOCATION KIT

This Milodon oil filter relocation kit for LS1 and LS7 engines gives you the flexibility to mount the oil filter in any desired location for ease of access or just to gain space for your engine transplant. The kit includes two braided hoses 36-inches long with -AN fittings and an oil filter mount
 All LS1 & LS7 #14629..... \$239.95/kit

MILODON REPLACEMENT OIL PANS

These Milodon replacement pans are the perfect replacement for your original pan. Unlike imported chrome pans, Milodon pans have flat unwrapped pan rails for a perfect glove fit. They feature very effective internal horizontal baffles for efficient oil control and their gold irradiated finish assures quality and a distinctive look. Drivers side dipstick. Pan holds five quarts, plus the filter. Measures 8-inch deep at the lowest point. Note: These pans require the use of the "thick" oil pan end gaskets. Danchuk #16996 will work on any 1955-1979 small block Chevy engine. Danchuk #16997 will work on any 1986 and up small block Chevy engine and for use with engines that have a 1-piece rear main.

- 1956-79 SB #16996..... \$129.95/ea.
- 1986-UP SB #16997..... \$139.95/ea.

MILODON OIL PAN OIL FILTER MOUNT KIT

This LS oil filter mount kit is exactly what you need when doing that LS conversion in your classic. CNC machined from T-6061 billet aluminum it is designed to mount the oil filter on the pan rail in the stock location allowing you to use the standard LS oil filter or the 40% larger GM filter for maximum filtration. Keeps the filter from hanging below the oil pan.

- 1955-57 LS1 & LS7 #18517 \$99.95/kit



MILODON LS OIL PAN WINDAGE TRAY

- All LS #14631 \$69.95/ea.



MILODON OIL PAN GASKETS

Milodon's one-piece pan gaskets end leaks at the corner where conventional individual pieces meet. These molded rubber gaskets are reusable and have steel inserts at each bolt hole so the pan bolts can be securely tightened yet the gasket can never be overtightened.

- 1956-79 SB exc. '55 V8 #12804..... \$32.95/ea.
- 1986-Up SB #12805..... \$37.95/ea.
- 1965-90 BB Mark IV..... #18752..... \$33.95/ea.
- All BB..... #12806..... \$40.95/ea.
- All LS..... #19041..... \$38.95/ea.



MILODON OIL PAN GASKETS

Milodon's crush-proof pan gaskets will not crush, split, shrink or squeeze out like inferior gaskets. For a leak free pan installation use the right gaskets the first time.

- 1956-85 SB #12784..... \$20.95/ea.
- 1965-85 BB #12785..... \$20.95/ea.



MILODON OIL PUMP PAN BAFFLES

Installs between the oil pump and rear main cap. This baffle prevents oil from climbing up the rear of the pan into the crankshaft during hard acceleration. An easy addition to assure added horsepower.

- All SB..... #12782..... \$9.95/ea.
- All BB..... #12783..... \$9.95/ea.

MILODON OIL PUMP PICK-UP'S

Milodon oil pans require the correct pick-up. Stock pick-up's are too big. Danchuk #18674 is designed for use with Milodon extra low profile pans, Danchuk # 12768 & 12769. Be sure to order the correct one for your Milodon pan.

- All Street Performance Pans..... #12771..... \$50.95/ea.
- All BB (Shown) #12772..... \$56.95/ea.
- All LS..... #14628..... \$100.95/ea.
- All BB for #12678 Pan..... #18674..... \$56.95/ea.



MILODON OIL PUMPS

Milodon hi-volume/hi-pressure pumps provide 20%-30% increase in volume and pressure. All BB..... #12773.... \$90.95/ea. All SB (Shown) #12774.... \$75.95/ea.



MILODON OIL PUMP PRIMER

Be sure to prime that fresh crate motor or rebuild with this priming tool from Milodon. All V8..... #13380..... \$42.95/ea.



MILODON OIL PUMP STUD KIT

A must for your high performance Chevy. Torque to 50 ft./lbs. with oil. Made from 8740 chrome moly steel.

- All SB/BB #12777..... \$9.95/kit





STAINLESS OIL PAN BOLTS

All SB, Hex.....	#13999.....	\$56.95/set
All SB, 12-Pt.	#14000.....	\$59.95/set
All BB, Hex.....	#14001.....	\$73.95/set
All BB, 12-Pt.	#14002.....	\$77.95/set



OIL PAN STUD KITS

1955-85 SB	#12786.....	\$22.95/ea.
All BB.....	#12787.....	\$31.95/ea.
All Auto, TH350, TH400 & PG.....	#13382.....	\$25.95/kit



OE OIL PAN BOLT SET

1955-64, '55-64 Vette	#1536.....	\$11.95/set
-----------------------------	------------	-------------



OE OIL PAN DRAIN PLUG

1955-57 w/ Gasket.....	#15439.....	\$1.25/ea.
------------------------	-------------	------------



REAR AXLE HOUSING/ OIL PAN DRAIN PLUG GASKETS

This gasket will work on both the oil pan and the rear axle housing drain plugs to prevent leaks.

1955-72	#14176.....	\$3.00/pr.
---------------	-------------	------------



1955 OE OIL FILTER LINES WITH FITTINGS

No substitutions here! Original design fittings and bends are combined in these high quality oil lines. Accurately restore the look and function of your lubrication system with this faithful reproduction.

1955 V8.....	#1526.....	\$32.95/set
1955 V8 W/ Factory A/C.....	#19147.....	\$34.95/set



MILODON OIL PUMP DRIVE SHAFTS



This race proven shaft is CNC machined from 4130 chrome moly and eliminates breakage-prone stock units. Good insurance regardless of applications.

All SB.....	#12775.....	\$15.95/ea.
All BB.....	#12776.....	\$15.95/ea.



OIL PAN GASKET SET

1955 265, 55-56 Corvette	#17912.....	\$20.95/set
--------------------------------	-------------	-------------



OIL PAN GASKET SET

1955-57 6-Cyl.....	#18135.....	\$16.95/set
--------------------	-------------	-------------

SMALL BLOCK V8 SPIN-ON OIL FILTER ADAPTER BOLT



Two of these bolts are required to install oil adapter shown above, part #16242.

1968-Up GM.....	#16243.....	\$2.95/ea.
-----------------	-------------	------------

#191



OIL FILTER ELEMENTS #192

It is interesting to note that only 1956 and 1957 V8 engines had integrated oil filter systems. All 6-cylinder and 1955 V8 engines had optional bolt-on units. These unique filters may be rare, but you can always find them at Danchuk.

- 1940-57 6-Cyl., '55 V8..... #191..... \$16.95/ea.
- 1956-57 V8 Long Canister, 7-5/8 . #192..... \$9.95/ea.
- 1958-67 V8 Short Canister, 6-3/4 #192A..... \$8.95/ea.

POWERFILTER OIL FILTERS

These Powerfilter oil filters have fully CNC machined housings and a washable double mesh stainless steel filter elements. Powerfilter oil filters feature quad bypass design to keep unfiltered oil from reaching the engine, O-rings on all sealing joints, 45 micron stainless filter element and a magnet in the base to collect tiny particles. This is the last filter you will ever have to buy for your classic.



- All 86 & Earlier V8 w/ Spin-On Filter..... #15600 \$119.95/ea.
- All Replacement Element, Standard, Large..... #15668..... \$25.95/ea.
- All O-Ring Replacement Kit #15667..... \$19.95/kit

REAR MAIN SEAL

This rubber rear main seal replaces the old rope seal and is much easier to install. Please make sure you offset the ends of the seal so they don't line up with the split between the main cap and block to prevent leaks.



- 1955-58 V8 #10309..... \$36.95/ea.

OIL PRESSURE SENDING UNIT

An excellent replacement to the original, this sending unit is top notch. If your old unit no longer works, this will fix your problem. 1955's will need to change wire terminal.



- 1955-57 #016..... \$9.95/ea.



OE OIL FILTER HOSES

Both the pressure and return hoses, reproduced to the original specifications, are included in this set.

- 1955-57 6-Cyl..... #1491..... \$43.95/set

OIL FILTER BYPASS VALVE KIT

Required with part #16642 when converting from canister type oil filter to spin-on type filters.



- 1956-67 #16643..... \$49.95/kit

OIL FILLER TUBES

Part #1981 is for use on early model small-block intake manifolds. Part #2335 includes return spring bracket.



- All..... #1981..... \$5.95/ea.
- 1956-65 V8 #2335..... \$39.95/ea.

OIL FILTER SPIN-ON CONVERSION KIT

With this conversion kit along with the required By-Pass Valve (part #16643) you can start using the more common and more economical spin-on filter.



- 1956-67 #16642..... \$29.95/kit

SMALL BLOCK V8 SPIN-ON OIL FILTER ADAPTER

This genuine GM adapter is made for 1968 and later GM motors. Works with all factory spin-on oil filters.



- 1968-Up GM..... #16242..... \$52.95/ea.



#14903



#13739



#13741



#13738

PROFESSIONAL PRODUCTS POWERFORCE HARMONIC DAMPERS

The Powerforce line of high performance street dampers are the highest quality, cost effective damper you can buy and are intended for non-SFI performance applications.

All SB, 6-3/4", Internal, Black	#13738.....	\$69.95/ea.
All SB, 6-3/4", External, Black	#13739.....	\$84.95/ea.
All SB, 8", External, Black	#13741.....	\$89.95/ea.
All SB, 6-3/4", Internal, Stainless.....	#14902.....	\$245.95/ea.
All SB 6-3/4", External, Stainless	#14903.....	\$249.95/ea.

PROFESSIONAL PRODUCTS POWERFORCE PLUS HARMONIC DAMPERS

The Powerforce Plus line are intended for racing applications or high performance street use and meet SFI spec #18-1 which means they can be safely revved in excess of 10,000 RPM.



All SB, 6-3/4", Internal..... #13747..... \$169.95/ea.

REPLACEMENT HARMONIC BALANCER

Accepts bolt-on pulleys. Timing mark is in a different location than the original '55-'57 V8. 6-inch balancer features 60 degrees of timing marks with engraved marks every 90 degrees.



All SB, 6", Internal #12601..... \$79.95/ea.

CRANK GEAR INSTALLATION TOOL

Use this tool with the balancer installer making it easy to press on crank gears straight.



All..... #13842..... \$21.95/ea.

HARMONIC BALANCER PULLER/INSTALLER

Works with all GM, Ford and Chrysler engines. This heavy-duty, professional tool equipped with roller thrust bearings, can also be used for steering wheels and pulley installation and removal. Kit includes 7/16"-20, 5/8"-18, and 3/4"-16 adapters and various removal hardware.



All..... #13840..... \$89.95/kit

ARP SQUARE DRIVE BALANCER BOLTS

All SB..... #14032..... \$57.95/ea.
All BB..... #14033..... \$57.95/ea.



OE HARMONIC BALANCER BOLTS

Use with steel bolt-on pulleys.
1955-57 #2891..... \$8.95/set



HARMONIC BALANCER INSTALLATION TOOL

This tool makes installing the balancer simple, just thread the proper end into the crankshaft and then rotate the nut which presses the bearing against the balancer which slides onto the crankshaft smoothly.

All..... #13841..... \$31.95/ea.



1-GROOVE CRANK PULLEY

Add-on pulley fits inside single groove pulleys to run power steering.

All SB, Short Water Pump..... #15031 \$47.95/ea.



2-GROOVE CRANK PULLEY

1955-57 SB, Short Water Pump.... #14986..... \$48.95/ea.

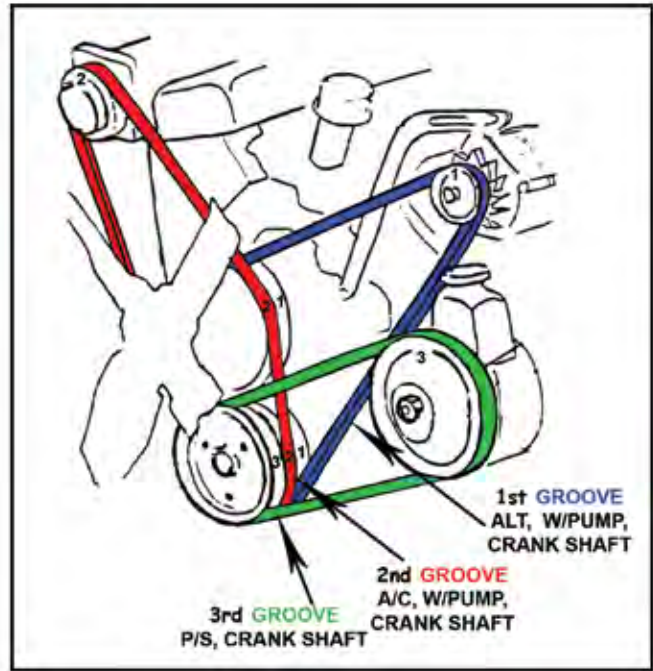

POLISHED BILLET ALUMINUM CRANKSHAFT PULLEY

All BB, 3-Groove, Short Pump #12475..... \$51.95/ea.

CRANK TURNING SOCKET TOOLS

This non-marring aluminum tool fits over the end of the crank when the balancer is removed and allows you to rotate the engine easily with a 1/2 drive ratchet or breaker bar.



All SB..... #13843..... \$21.40/ea.

All BB..... #13844..... \$21.95/ea.



#17053



#17054



#17055



#17056

BILLET SPECIALTIES CRANK PULLEYS

- All SB, Short Water Pump, 2-Groove, Polished #17053..... \$74.95/ea.
- All SB, Short Water Pump, 3-Groove, Polished #17054..... \$82.95/ea.
- All SB, Long Water Pump, 2-Groove, Polished #17055..... \$79.95/ea.
- All SB, Long Water Pump, 3-Groove, Polished #17056..... \$89.95/ea.
- All BB, Short Water Pump, 2-Groove, Polished #17057..... \$84.95/ea.
- All BB, Short Water Pump, 3-Groove, Polished #17058..... \$82.95/ea.



#16337

ALUMINUM CRANKSHAFT PULLEY BOLTS

For use with our aluminum crankshaft pulleys, one set per pulley.

All SB..... #16337 \$3.95/set

All BB..... #16338..... \$3.25/set



#16336



SHOW QUALITY AIR CONDITIONING BELTS

These belts are made to GM specifications with correct materials, and bear the GM logo as it appeared on original 5-6-7 belts.

1955.....	#2504.....	\$39.95/ea.
1956.....	#2505.....	\$39.95/ea.
1957.....	#2506.....	\$39.95/ea.



DRIVER QUALITY FAN BELTS

High-quality parts are as reliable as they come!

1955-57 6-Cyl. w/ Power Steering	#042.....	\$17.95/ea.
1955-57 6-Cyl. w/o Power Steering (Shown)	#043.....	\$14.95/ea.
1955-57 V8 w/ Power Steering	#040.....	\$18.95/ea.
1955-57 V8 w/o Power Steering	#041.....	\$19.95/ea.



SHOW QUALITY FAN BELTS

Designed to stand up to tremendous heat and friction, these sturdy belts are made to General Motors' specifications with correct materials, and bear the GM logo as it appeared on original 5-6-7 belts.

1955-57 V8 w/ Heavy Duty Generator	#2500.....	\$38.95/ea.
1956 V8 w/ Dual 4BC, RPO 411	#2501.....	\$36.95/ea.
1957 V8 w/ Dual 4BC, RPO 411	#2502.....	\$37.95/ea.
1957 V8 w/ Fuel Injection, RPO 578	#2503.....	\$36.95/ea.
1955-57 V8 w/o Power Steering (Shown)	#2498.....	\$36.95/ea.
1955-57 V8 w/ Power Steering (Shown)	#2499.....	\$36.95/ea.



#17048

#17052

BILLET SPECIALTIES WATER PUMP PULLEYS

All SB, 2-Groove, Short, Polished..	#17048.....	\$79.95/ea.
All SB/BB, 2-Groove, Long, Polished		
.....	#17052.....	\$89.95/ea.
All BB, 1-Groove, Short, Polished..	#18523.....	\$89.95/ea.
All BB, 2-Groove, Short, Polished..	#18524.....	\$89.95/ea.



#12443

#12441

WATER PUMP PULLEYS

1955-68 SB, 1-Groove, Short Pump, 7.08" Diameter	#2278.....	\$18.95/ea.
All SB, 1-Groove, Polished Billet, Short Pump	#12441.....	\$51.95/ea.
All SB, 2-Groove, Polished, Short Pump	#12443.....	\$59.95/ea.
All BB, 2-Groove, Polished, Short Pump	#12469.....	\$49.95/ea.



BILLET SPECIALTIES SHORT WATER PUMP PULLEY NOSE CONE

All SB/BB, Polished.....	#17049.....	\$19.95/ea.
--------------------------	-------------	-------------



BILLET SPECIALTIES LONG WATER PUMP PULLEY NOSE CONE

All Polished.....	#17345.....	\$19.95/ea.
-------------------	-------------	-------------



OE ORIGINAL STYLE WATER PUMP PULLEY

This is a replacement, double groove pulley for power steering and air conditioning conversions.

1955-68 2-Groove, SB, Short Pump
 #12727 \$69.95/ea.



WATER PUMP REBUILD KIT

This rebuild kit includes the impeller, shaft, seals, bearings, gaskets, and fasteners.

1955-57 #1530 \$69.95/kit



POLISHED BILLET WATER PUMP PULLEY NOSES

All Short Pump..... #12449..... \$17.95/ea.
All Long Pump #12465..... \$17.95/ea.



WATER PUMP PULLEY SHIMS

This 3-piece kit helps you to fine tune water pump pulley alignment.

All..... #13722 \$7.95/set

ALUMINUM WATER PUMP PULLEY BOLTS

For use with our aluminum water pump pulley. One set per pulley required.

All SB/BB..... #16336 \$3.95/set

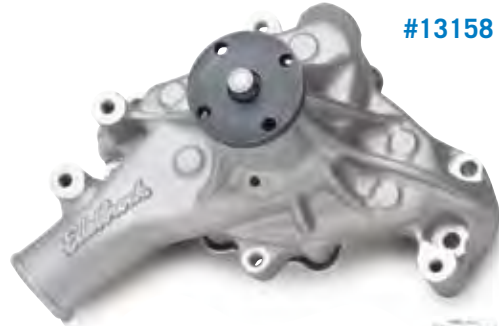

EDELBROCK ALUMINUM WATER PUMPS

Edelbrock water pumps are ideal to prevent overheating in street machines and feature state of the

art cooling technology. These supercooling water pumps provide equal distribution to both sides of the block and flow in only one direction for maximum efficiency. Pumps listed are standard rotation only.

All SB, Short, Satin #13154..... \$269.95/ea.
All SB, Long, Satin #13158..... \$248.95/ea.
All SB, Short, Endurashine..... #13365..... \$346.95/ea.
All SB, Long, Endurashine #13366..... \$338.95/ea.



OE STAINLESS WATER PUMP BOLTS

Rust and corrosion make periodic replacement of these bolts a necessity. Make sure you replace them when installing a new water pump. Short pumps only.

1955-72 #2244 \$10.95/set



WATER PUMP FITTINGS

1955-56 5/8" #10067 \$17.95/ea.
1957 3/4" #12226 \$11.95/ea.



STAINLESS WATER PUMP BOLT KITS WITH BOWTIE

All SB, Short Water Pump..... #14292..... \$8.95/kit

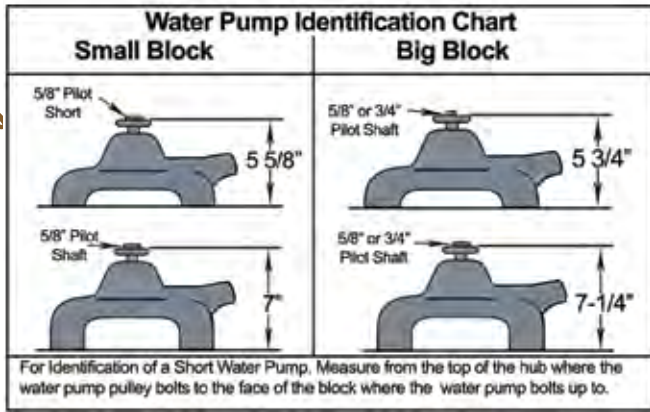

BILLET SPECIALTIES TOP MOUNT AIR CONDITIONER COMPRESSOR BRACKETS

- All SB w/ Short Water Pump (Shown) #18824..... \$125.95/ea.
- All SB Vortec w/ Short Water Pump #18826..... \$146.95/ea.
- All BB w/ Short Water Pump #18828..... \$146.95/pr.



REPLACEMENT WATER PUMPS

These replacement water pumps are brand new and function like the originals.

- 1955-57 6-Cyl. #170..... \$64.95/ea.
- 1955-68 V8 #171..... \$39.95/ea.



WATER PUMP GASKETS

- All 235 6-Cyl. (Shown)..... #19461..... \$1.45/ea.
- All V8..... #19462..... \$1.55/ea.



BILLET SPECIALTIES TOP MOUNT ALTERNATOR BRACKETS

- All SB w/ Short Water Pump #18825..... \$125.95/ea.
- All SB Vortec w/ Short Water Pump (Shown) #18827..... \$146.95/ea.
- All BB w/ Short Water Pump #18829..... \$125.95/ea.



ARP STAINLESS WATER PUMP BOLTS

- All Hex, All V8 Pumps #14013..... \$36.95/set
- All 12-Pt., All V8 Pumps..... #14014..... \$36.95/set

HEATER HOSE TO WATER PUMP FITTING

- These fittings are for use on small-block and big block water pumps.
- All Chrome, 3/4" V8..... #1961..... \$5.95/ea.



VINTAGE AIR FRONT RUNNER ENGINE COMPONENT DRIVE SYSTEMS

Each system includes a main truss bracket, tensioner, power steering (or power steering delete) bracket, crankshaft pulley, water pump pulley, alternator, high volume aluminum water pump, power steering pump with pulley (with power steering kit), serpentine belt, and hardware kit. Bright finish pulley kits include polished tensioner cover and clutch cover.



FRONT RUNNER COMPLETE COMPONENT KITS

With Power Steering:

All SB, Black	#12535	\$2245.95/kit
All SB, Bright.....	#12537	\$2295.95/kit
All BB, Black	#12535A	\$2380.95/kit
All BB, Bright.....	#12537A	\$2410.95/kit
All LS1/LS6, Bright.....	#15008	\$2925.95/kit
All LS1/LS6, Black.....	#15010	\$2825.95/kit
All LS7, Bright	#15012	\$2925.95/kit
All LS7, Black.....	#15014	\$2825.95/kit

Without Power Steering:

All SB, Bright.....	#12536	\$2105.95/kit
All BB, Black	#12534A	\$2170.95/kit
All BB, Bright.....	#12536A	\$2225.95/kit
All LS1/LS6, Bright.....	#15009	\$2705.95/kit
All LS1/LS6, Black.....	#15011	\$2605.95/kit
All LS7, Bright	#15013	\$2675.95/kit



#12542



#12543

FRONT RUNNER TENSIONER COVER KITS

All Satin	#12542.....	\$42.95/kit
All Polished.....	#12543.....	\$54.95/kit



BILLET SPECIALTIES TOP MOUNT AIR CONDITIONING & ALTERNATOR BRACKETS

Designed for use with GM 60 to 80 amp alternators & Sanden 508 AC compressor. This bracket is CNC machined from 6061-T6 billet aluminum and polished to a mirror finish. Ideal for small block Chevrolet motors that do not have mounting holes in the cylinder heads. This bracket mounts to the water pump and intake manifold to ensure stability and belt tension. Designed for use with short water pumps, GM 10SI / 12SI alternator and Sanden 508 AC compressor.

All Polished..... #17045..... \$249.95/ea.

BILL'S HOT ROD BRACKETS

For strength and durability, these brackets are made of 1/4" mild steel plate, finished off in your choice of bare steel, black or chrome plating. Each bracket comes completely assembled, with adjusting arms, all the necessary stainless steel washers and allen head bolts, an illustrated instruction sheet, belt size recommendations and adjusting tips for an easy installation. The alternator used is a GM, and the air conditioning compressor is a Sanden SD-508. Stock steel or aluminum aftermarket pulleys can be used with these brackets.

BILL'S HOT ROD BRACKETS



BILL'S HOT ROD ALTERNATOR BRACKETS

Mounts alternator on driver side.

All SB w/ Late Style Heads, Short Water Pump, Black	#18194.....	\$119.95/ea.
All SB w/ Late Style Heads, Long Water Pump, Black	#18196.....	\$119.95/ea.
All SB w/ Early Style Heads, Short Water Pump, Black	#18198.....	\$149.96/ea.
All SB w/ Late Style Heads, Short Water Pump, Bare	#18205.....	\$124.95/ea.
All SB w/ Late Style Heads, Short Water Pump, Black	#18206.....	\$144.95/ea.
All SB w/ Late Style Heads, Short Water Pump, Chrome	#18207.....	\$199.95/ea.
All SB w/ Late Style Heads, Short Water Pump, Bare	#12546.....	\$99.95/ea.
All SB w/ Late Style Heads, Short Water Pump, Chrome	#12547.....	\$169.95/ea.
All SB w/ Late Style Heads, Long Water Pump, Bare.....	#12548.....	\$99.95/ea.
All SB w/ Late Style Heads, Long Water PumpChrome	#12549.....	\$164.95/ea.
All SB w/ Early Style Heads, Short Water Pump, Bare.....	#12550.....	\$109.95/ea.
All SB w/ Early Style Heads, Short Water Pump, Chrome	#12551.....	\$199.95/ea.
All BB w/ Short Water Pump, Black	#18202.....	\$124.95/ea.
All BB w/ Short Water Pump, Bare.....	#12556.....	\$119.95/ea.
All BB w/ Short Water Pump, Chrome	#12557.....	\$199.95/ea.



ALTERNATOR BRACKETS

This alternator bracket is for use on big-block engines equipped with the long water pump.

All..... #1985..... \$12.95/ea.

For use with small-blocks when converting the alternator to a side mount with headers. Use with #1982 and #1987.

All..... #1986..... \$10.95/ea.

For use on small-blocks with headers and a short style water pump. Use with #1986.

All..... #1982..... \$11.95/ea.

All..... #1987..... \$11.95/ea.



BILL'S HOT ROD AIR CONDITIONING BRACKET ADD-ONS

Use these air conditioning bracket with part #12550, #12551, #12556 and #12557 when adding air conditioning to your classic.

All SB, Bare..... #13718..... \$87.95/ea.

All SB, Chrome
 #13719..... | \$159.95/ea. |

All BB, Bare..... #13720..... \$93.95/ea.

All BB, Chrome
 #13721..... | \$164.95/ea. |

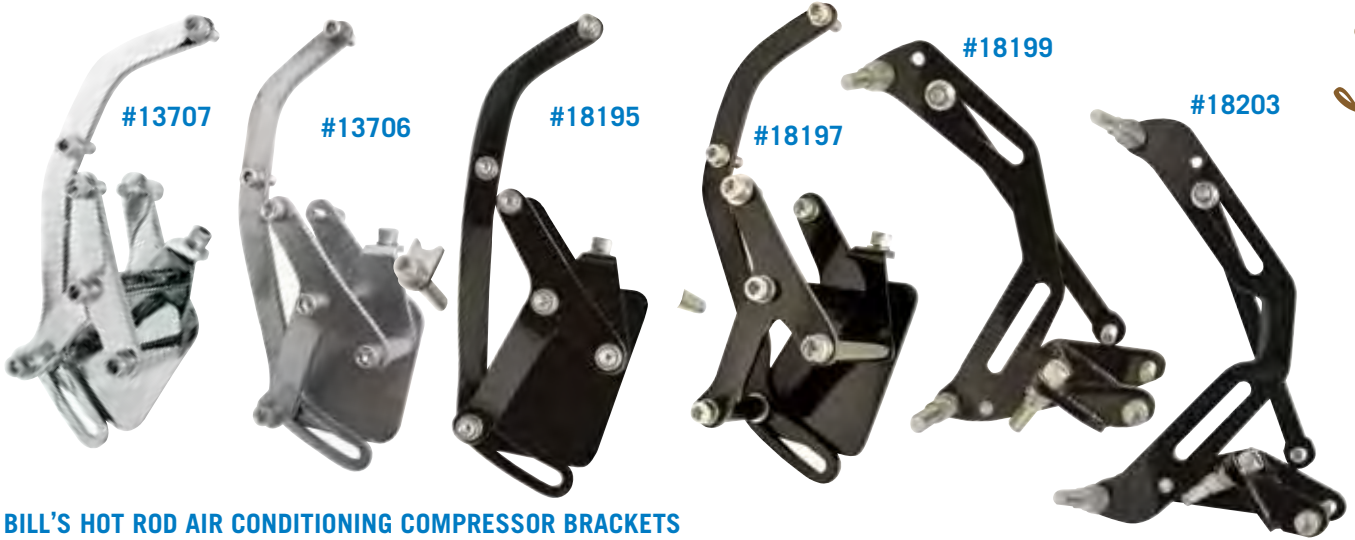

BILL'S HOT ROD AIR CONDITIONING COMPRESSOR BRACKETS

Mounts on passenger side.

All SB w/ Late Style Heads, Short Water Pump, Bare.....	#13706.....	\$99.95/ea.
All SB w/ Late Style Heads, Short Water Pump, Chrome	#13707.....	\$169.95/ea.
All SB w/ Vortec Heads, Short Water Pump, Bare	#13708.....	\$109.95/ea.
All SB w/ Vortec Heads, Short Water Pump, Chrome.....	#13709.....	\$189.95/ea.
All SB w/ ZZ Fast Burn Heads, Short Water Pump, Bare	#13710.....	\$109.95/ea.
All SB w/ ZZ Fast Burn Heads, Short Water Pump, Chrome.....	#13711.....	\$199.95/ea.
All SB w/ Late Heads, Long Water Pump, Chrome.....	#13713.....	\$189.95/ea.
All SB w/ Vortec Heads, Long Water Pump, Bare.....	#13714.....	\$122.95/ea.
All SB w/ Vortec Heads, Long Water Pump, Chrome	#13715.....	\$199.95/ea.
All SB w/ ZZ Fast Burn Heads, Long Water Pump, Bare	#13716.....	\$122.95/ea.
All SB w/ ZZ Fast Burn Heads, Long Water Pump, Chrome	#13717.....	\$199.95/ea.
All SB, w/ Late Style Heads, Short Water Pump, Black	#18195.....	\$119.95/ea.
All SB, w/ Late Style Heads, Long Water Pump, Black	#18197.....	\$119.95/ea.
All BB, Short Water Pump, Black	#18203.....	\$145.95/ea.
All SB, w/ Late Style Heads, Short Water Pump, Plain	#18208.....	\$124.95/ea.
All SB, w/ Late Style Heads, Short Water Pump, Black	#18209.....	\$139.95/ea.
All SB, w/ Late Style Heads, Short Water Pump, Chrome	#18210.....	\$199.95/ea.

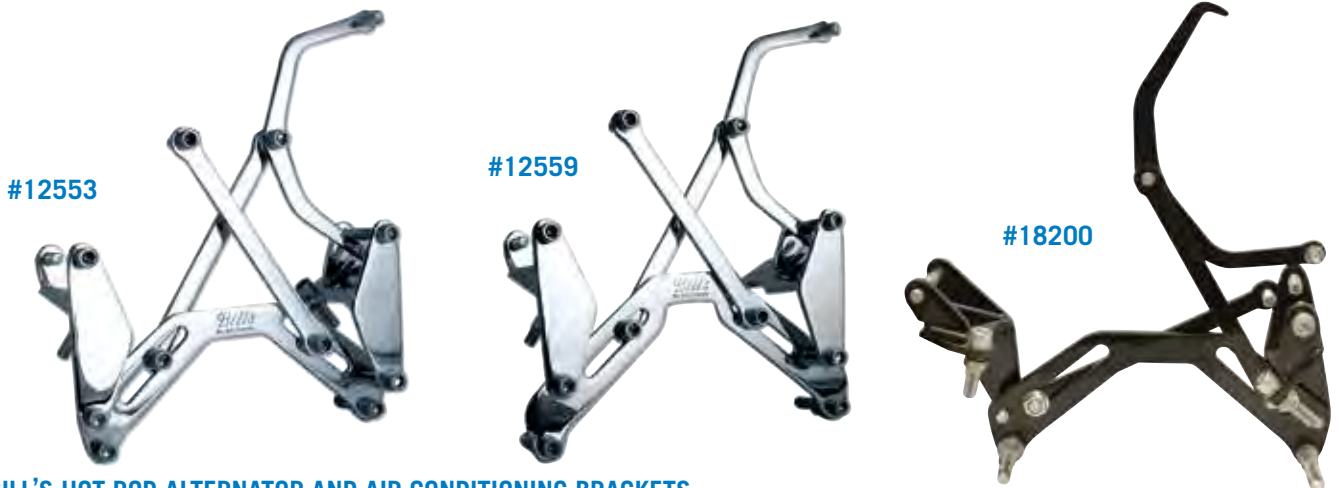

BILL'S HOT ROD ALTERNATOR AND AIR CONDITIONING BRACKETS

All SB w/ Early Style Heads, Short Water Pump, Bare.....	#12552.....	\$179.95/kit
All SB w/ Early Style Heads, Short Water Pump, Chrome	#12553.....	\$314.95/kit
All SB w/ Early Style Heads, Short Water Pump, Black	#18200.....	\$219.95/ea.
All BB w/ Short Water Pump, Bare.....	#12558.....	\$219.95/kit
All BB w/ Short Water Pump, Chrome	#12559.....	\$349.95/kit

**BILLET SPECIALTIES
V-TRAC PULLEY
SYSTEM**

Superior engineering, high tech styling, quality components combine to create a compact package for the small block Chevy. V-Trac systems are polished and include a 150 amp alternator with a billet one-piece alternator fan and pulley, natural finish Edelbrock water pump, billet water pump pulley, billet bridge bracket, billet crank pulley, polished ARP 12-point stainless hardware, Sanden SD-7 compressor, billet compressor clutch cover, power steering pump with AN fittings, billet power steering pump pulley, Goodyear Gatorback V-belts and a comprehensive installation manual. Not designed for use with hydro boost brake systems.



#17042



#17040

- All SB, w/ Power Steering & A/C, Polished
..... #17044... \$1395.95/ea.
- All BB, w/o Power Steering & A/C, Polished
..... #18823... \$1565.95/ea.

**EDDIE MOTORSPORTS
S-DRIVE
SERPENTINE PULLEY
SYSTEMS**

S-Drive pulley systems offer the latest in serpentine drive systems. They feature all new components and **Made in the USA** billet pulleys and brackets. Components included are: Sanden SD7 compressor, Type 2 P/S pump w/reservoir (remote on LS models), alternator and water pump. LS versions include an ATI damper. All components are matched to take the guesswork out of getting the right parts. Available in either machined satin finish or highly polished. Polished versions include a polished compressor, alternator and water pump. Non-power steering versions and custom colors are available by special order.



**BILLET SPECIALTIES
PREMIUM TRU TRAC SERIES PULLEY SYSTEMS**

Premium Tru Trac Pulley Systems are designed with the discriminating hot rodder in mind. They feature a polished 140 amp alternator, billet alternator fan and pulley, Edelbrock Endurashine reverse rotation water pump (except LS7), billet pulleys and brackets, ARP stainless fasteners, serpentine belt, installation manual and the Billet Specialties patent pending billet aluminum tensioner engineered specifically for the Tru Trac systems. Tru Trac is not designed to be used with hydroboost brake systems.

- Black finish available by special order.**
- All SB, Power Steering & A/C, Polished
..... #17040... \$2395.95/ea.
- All BB, Power Steering & A/C, Polished
..... #17041... \$2495.95/ea.
- All LS1-LS6, Power Steering & A/C, Polished
..... #17042... \$2779.95/ea.
- All LS7, Power Steering & A/C, Polished
..... #17043... \$2779.95/ea.
- 1955-57 LT4, Black..... #19369... \$2495.95/ea.
- 1955-57 LS1-6 W/PS & AC, Black
..... #19370... \$3064.95/ea.
- 1955-57 Tru Trac, SB W/PS & AC, Black
..... #19371... \$2549.95/ea.
- 1955-57 Tru Trac, BB W/PS & AC, Black
..... #19372... \$2654.95/ea.
- 1955-57 LS 7, W/PS & AC, Black. #19385... \$3064.95/ea.

VICTORY PULLEY SYSTEMS

The Victory Series pulley systems are designed to keep the accessory drive components within the boundaries of the engine block and are available in either a polished or machined finish. All kits feature Sanden SDT compressor with billet manifold, short style aluminum water pump, 150 amp alternator, all pulleys, covers, brackets, belts and chrome plated hardware. Kits with power steering also include aluminum pump and pulley with mounted billet aluminum mini reservoir.



#14781



#14783

Kit Includes all new components; Tuff Stuff water pump, Maval power steering pump, Sanden style SD7 A/C compressor, Powermaster 140-amp alternator, Gates v-belts, and all necessary stainless steel fasteners. Polished kits include a polished finish A/C compressor and alternator. Colored kits come with natural cast finished components. Specify type of steering (gear box or rack & pinion) when placing your order.

All SB w/ Power Steering, Polished (Shown)	#14781	\$2150.95/set
All SB w/ Power Steering, Machined	#14782	\$2395.95/set
All SB w/o Power Steering, Polished (Shown)	#14783	\$1845.95/set
All SB w/o Power Steering, Machined	#14784	\$1650.95/set
All BB w/ Power Steering, Polished	#14785	\$2245.95/set
All BB w/ Power Steering, Machined	#14786	\$2195.95/set
All BB w/o Power Steering, Polished	#14787	\$1995.95/set
All BB w/o Power Steering, Machined	#14788	\$1700.95/set
All LS w/o Power Steering, Polished	#16518	\$2150.95/set
All LS w/o Power Steering, Machined	#16519	\$1950.95/set
All LS w/ Power Steering, Polished	#16520	\$2495.95/set
All LS w/ Power Steering, Machined	#16521	\$2300.95/set

V-DRIVE PULLEY KITS

The new V-Drive systems from Eddie Motorsports offer the same complete, compact design and simple installation as their S-Drive serpentine drive systems but at a more affordable price. One part number gives you everything you need to accessorize your engine with American made billet aluminum and new, name brand components.



#18187



#18191

Also available for big block applications. Kit Includes all new components; Tuff Stuff water pump, Maval power steering pump, Sanden style SD7 A/C compressor, Powermaster 140-amp alternator, Gates v-belts, and all necessary stainless steel fasteners. Polished kits include a polished finish A/C compressor and alternator. Colored kits come with natural cast finished components. Specify type of steering (gear box or rack & pinion) when placing your order.

All SB w/ Plastic Power Steering Reservoir, Polished	#18187	\$1495.95/kit
All SB w/ Plastic Power Steering Reservoir, Gloss Black	#18188	\$1575.95/kit
All SB w/ Billet Power Steering Reservoir, Polished	#18189	\$1670.95/kit
All SB w/ Billet Power Steering Reservoir, Gloss Black	#18190	\$1790.95/kit
All SB for Remote Power Steering Reservoir, Polished	#18191	\$1395.95/kit
All SB for Remote Power Steering Reservoir, Gloss Black	#18192	\$1495.95/kit

WARNING! Products on these pages may contain chemicals known to the State Of California to cause cancer and/or birth defects or reproductive harm. www.p65warnings.ca.gov

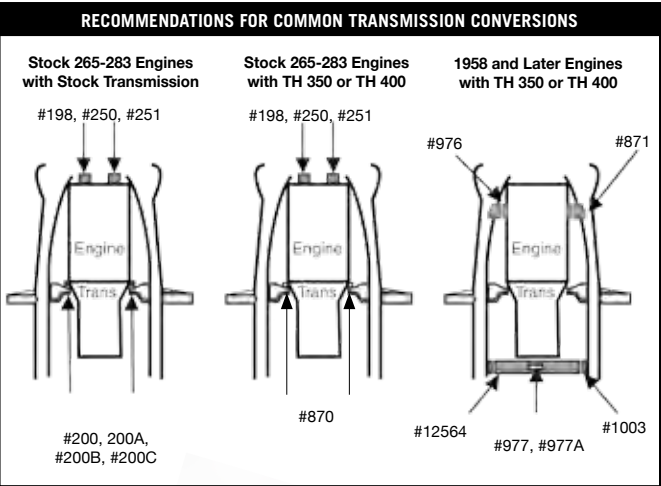

OE TRANSMISSION MOUNT TO FRAME BOLTS
 1955-57 All #15419..... \$3.95/set



OE TRANSMISSION MOUNT TO BELL HOUSING BOLTS
 1955-57 Standard #15417 \$2.95/set
 1955-57 Powerglide..... #15418 \$2.95/set



ARP STAINLESS STEEL BELL HOUSING BOLT KITS
 ARP stainless bell housing bolts are designed to securely attach your transmission bell housing to your engine block.

All Hex.....	#18756.....	\$32.95/kit
All 12-Pt.	#18757.....	\$38.95/kit
All LS, Hex	#18758.....	\$59.95/kit
All LS, 12-Pt.....	#18759.....	\$59.95/kit



#200/200A

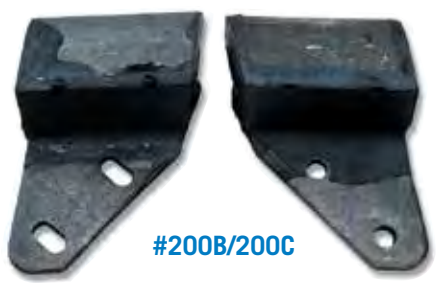

#200B/200C



#977

#977A

TRANSMISSION MOUNTS

1955-57 Auto, Driver (Shown).....	#200.....	\$21.95/ea.
1955-57 Auto, Passenger	#200A.....	\$21.95/ea.
1955-57 Standard, Driver	#200C.....	\$21.95/ea.
1955-57 Standard, Passenger (Shown)	#200B.....	\$21.95/ea.
1955-57 TH350, 700R4, 200-4R & All 4-Speeds	#977A.....	\$14.95/ea.
1955-57 TH400	#977.....	\$14.95/ea.



URETHANE TRANSMISSION MOUNTS
 Urethane mounts feature a safety interlock design and are impervious to oils and chemicals. They are strong for hi-performance use, yet soft enough for a smooth operation.

All Auto & Standard, Zinc.....	#15047.....	\$36.95/ea.
All Auto & Standard, Chrome	#15048.....	\$74.95/ea.



- A: Upper Brackets (1 rh, 1 lh)
- B: Upper Bracket Spacers (4)
- C: Lower Brackets (1 rh 1 lh)
- D: Rubber Bushing (4)
- E: Bolts (2)
- F: Fat Washers (4)
- G: Nuts (2)

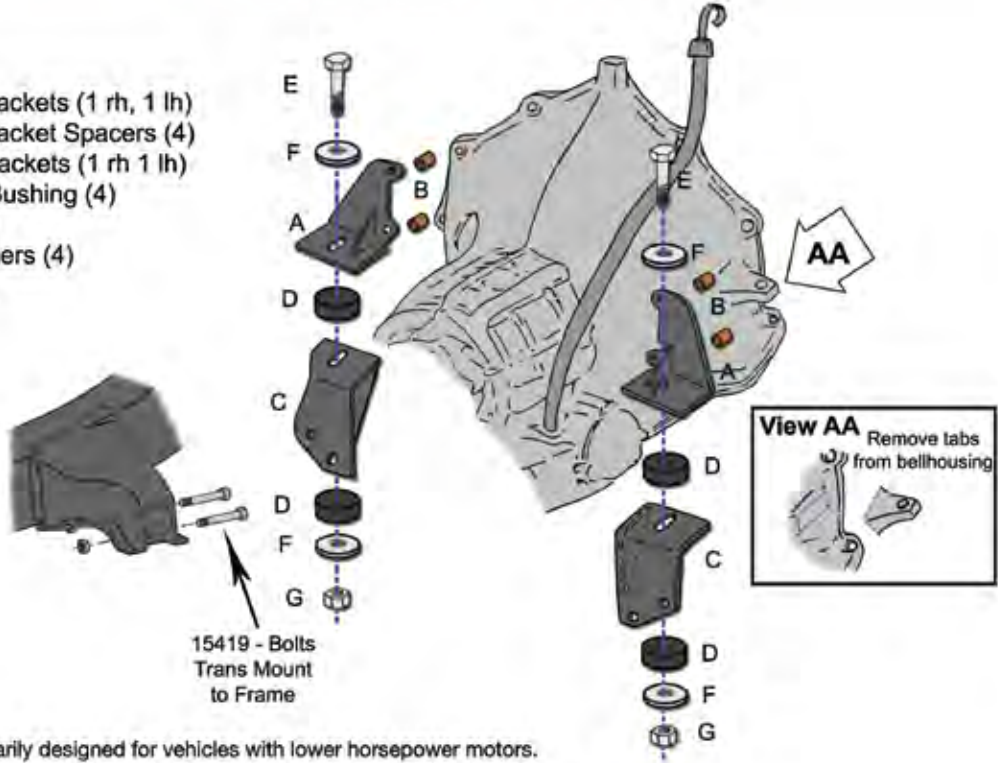

This kit is primarily designed for vehicles with lower horsepower motors.

TRANSMISSION SIDE MOUNT CONVERSION KITS

This conversion kit makes mounting the TH350, 400 and 700R4 transmissions a breeze. (This kit will also fit late model Chevrolet transmissions, such as the 200-4R, with minor modifications.) Engineered to last, our conversion kit is built with components that far exceed the strength that is required of them. Rubber cushioned to absorb shock and vibration. Easy to install; simply bolt it to the frame. Must use with front factory motor mounts. Not recommended for high performance applications. **Made in the USA.**

1955-57 TH350, TH400, 700R4, 200-R4	#870.....	\$119.95/kit
1955-57 Hardware Only.....	#870A.....	\$27.95/kit

WARNING! Products on these pages may contain chemicals known to the State Of California to cause cancer and/or birth defects or reproductive harm. www.p65warnings.ca.gov



TRANSMISSION CROSS MEMBERS

Unless otherwise noted these work with TH350, TH400, 700R4, 200-4R, and 4L60-4L80 transmissions (these we know for sure, there may be more). Part #12564 needs transmission cross member end brackets #1003, shown below. Parts #12196 through #12199 end brackets require welding for installation. For complete installation, use transmission mounts #977 or #977A, shown on page 510.

1955-57 Convertible Only, Aluminum Powerglide & TH350 Only	#875A.....	\$59.95/ea.
1955-57 Rear, exc. 5 & 6-Speed, Black	#12564.....	\$99.95/ea.
1955-57 5 & 6-Speed, Bare.....	#12196.....	\$199.95/ea.
1955-57 Bare.....	#12198.....	\$134.95/ea.
1955-57 Powdercoated Black.....	#12199.....	\$229.95/ea.



TUBULAR TRANSMISSION CROSS MEMBER

The best of both worlds, hassle-free installation and mega exhaust clearance. The unique drop of this crossmember allows oversized exhaust pipes to tuck up high between the frame rails. Its balanced NO-weld design makes installation easy. No need to juggle the mounts, crossmember, transmission and brackets at the same time, simply rest the crossmember and brackets on the frame and transmission on the crossmember. Bolt it all down after it is centered between the rails. This fits all GM transmissions with popular 2-bolt mount.

1955-57	#14789.....	\$109.95/kit
---------------	-------------	--------------



TRANSMISSION CROSS MEMBER END BRACKETS

Required when using part #12564. Hardware not included. Made in the USA.

1955-57	#1003.....	\$18.95/pr.
---------------	------------	-------------

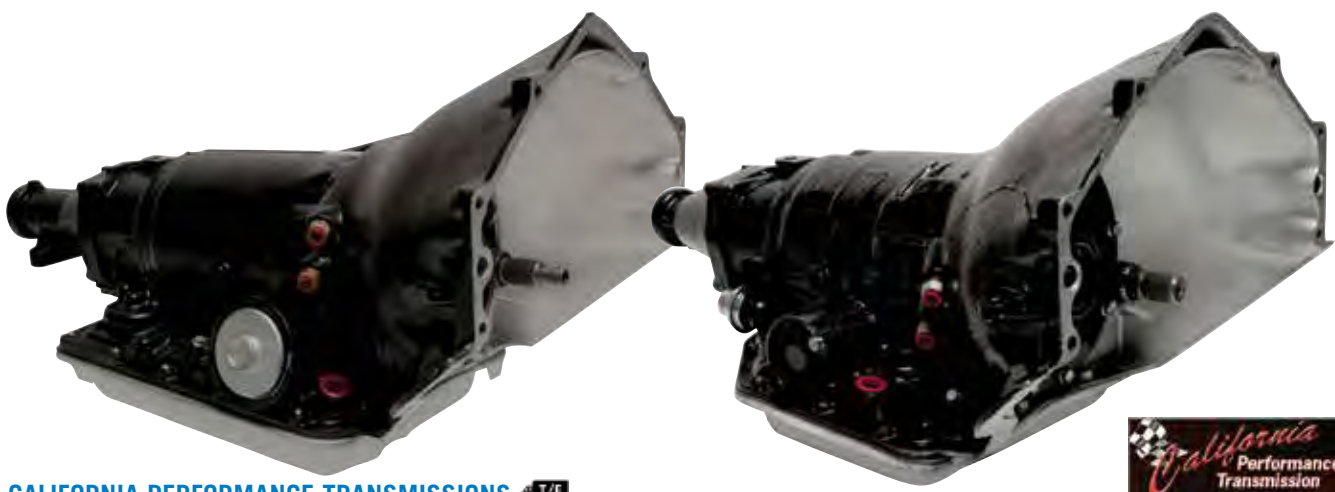

CALIFORNIA PERFORMANCE TRANSMISSIONS 

Built by California Performance Transmissions, home to Hot Rod Hall of Famer Art Carr, Danchuk carries a transmission for every need. The 200-4R transmissions have long been a great transmission for street rods and with the addition of an overdrive gear it can give you better mileage, lower cruise RPM, up to 300% longer engine life. Another benefit is the 200-4R is the same length as a TH350 and cast iron Powerglide. This means the stock driveshaft from your original cast iron Powerglide can be reused by just changing the slip yoke (See #11295). The gear shift and cooler lines are located the same as the TH350 so hook up is easy with off the shelf parts. For cooler lines see (# 1551/1597/2191) and shift linkage kit #11283 for column shift. The 200-4R uses a throttle valve cable and bracket that hooks to your carburetor or throttle body and gives you control over your shift points. The #18981 TH350 transmission comes with the six-inch long tail. It is the same size as a manual set up or powerglide so you can use your existing driveshaft without cutting, just change the yoke. The #18981 can handle an engine which puts out between 250 and 400 HP. The #18984 can handle an engine which puts out up to 400 HP. And the #18985 can handle an engine which puts out between 400 and 500 HP. All are excellent choices when choosing a GM transmission to put into your classic. Truck freight shipping required.

All 200-4R, 400-500 HP	#16966	\$1995.95/ea.
All 200-4R, 200-400 HP	#16967	\$1499.95/ea.
All TH350 with 6" Tail, 250-400 HP	#18981	\$1249.95/ea.
All 700R4, up to 400HP	#18984	\$1699.95/ea.
All 700R4, 400-500HP	#18985	\$2149.95/ea.



DRIVE SHAFT YOKE
 1955-57 27 Spline, Muncie, Aluminum Powerglide, TH350, 700R4 & 200-4R..... **#11295..... \$101.95/ea.**

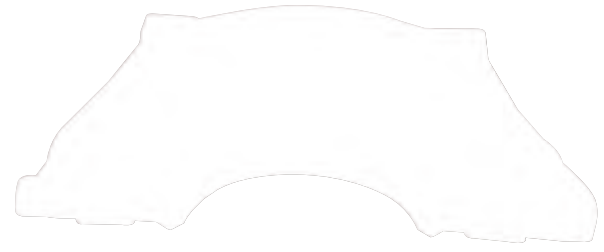

UNIVERSAL DUST COVER
 This plastic universal converter cover has guide templates for various starter location cut-outs and slotted mounting holes to fit.
All 700R4 & 200-4R..... **#16974..... \$39.95/ea.**



UNIVERSAL JOINT
 This heavy-duty universal joint comes complete with retainer clips; two required per car.
1955-57
 #007..... | **\$15.95/ea.** |



TCI DRAIN PLUG KIT
All Universal..... **#13039..... \$8.95/kit**

#18986



#18982

CALIFORNIA PERFORMANCE TRANSMISSIONS TORQUE CONVERTERS



- All TH350/400, 12" 2200 Stall #18982..... \$289.95/ea.
- All TH350/400, 10" 2600-2800 Stall #18983..... \$559.95/ea.
- All 700R4, 12" 2200 Stall #18986..... \$289.95/ea.
- All 700R4, 10" 2600-2800 Stall #18987..... \$559.95/ea.

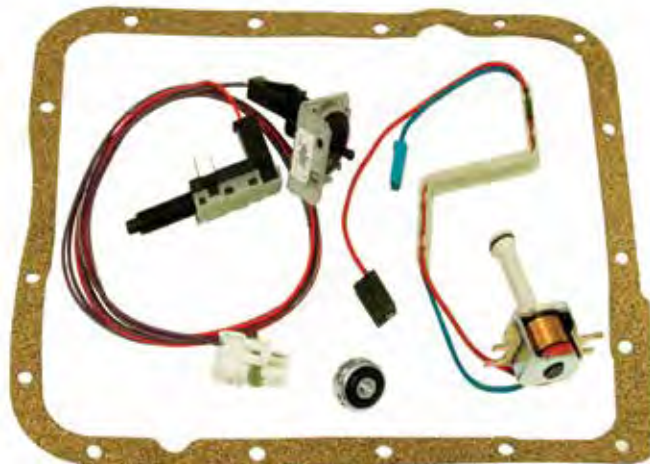

TORQUE CONVERTER LOCK-UP KITS

Now you can control the lock-up function on your over-drive transmission with your carbureted engine and not have to buy any expensive computer. A vacuum controlled switch and a fourth gear pressure switch/lock up solenoid combination controls the lockup. Kit comes complete with everything to complete the installation including a new pan gasket.

- All 700R4..... #14604..... \$236.95/ea.
- All 200-4R #14605..... \$208.95/ea.

200-4R NON-LOCKUP TORQUE CONVERTERS

The revolutionary Street Converter (2000-2200 RPM stall speed) came from research and development of off road competition. These converters offer a slightly higher stall speed that will allow greater torque bands at medium and high speeds, and increased lock-up at higher RPM ranges. In addition there's an increase in fuel mileage at cruise speed. The 10-inch converter is recommended for vehicles in excess of 450hp. You'll get 52 extra horsepower over stock converters with the HD Super Torque converter. Heavy duty converters feature; furnace brazed, 4130 steel turbine hubs, billet stator caps, 3 Torrington bearings and balanced within 5 grams.



- All 10", Heavy Duty #16968..... \$589.95/ea.
- All 12" #16976..... \$289.95/ea.



TRANSMISSION INSPECTION PLATE COVER

- 1955-57 #16091..... \$9.95/ea.

ARP TORQUE CONVERTER BOLT KITS

ARP torque converter bolts are manufactured from 8740 chromoly steel and feature 200,000 psi tensile strength.



- All 3/8-24, TH350/400 #18760..... \$25.95/kit
- All 7/16-20, TH350/400 #18761..... \$17.95/kit
- All 3-Piece M10X1.5, 700R4, 200-4R/kit #18762..... \$18.95/kit
- All 6-Piece M10X1.5, 700R4, 200-4R #18763..... \$34.95/kit



TORQUE CONNECTOR LOCK-UP SWITCH

This wire and switch kit allows the installation of computer controlled transmissions without all the work involved to install the computer control unit.

- All 700R4 & 200-4R #12347 \$79.95/ea.

OIL PANS



PML ALUMINUM DEEP TRANSMISSION PANS

Help make your transmission last longer with a deep sump transmission pan. By adding an additional 2 to 2.5 quarts of fluid this helps keep transmission temps down while the cooling fins help dissipate heat. Available for most popular transmissions.

All 200-4R, Cast.....	#17393.....	\$239.95/ea.
All TH350, Cast.....	#17394.....	\$229.95/ea.
All TH400, Cast.....	#17395.....	\$229.95/ea.
All 700R4/4L60E, Cast.....	#17396.....	\$234.95/ea.



TCI CAST ALUMINUM TRANSMISSION PANS

These are designed with cooling fins to help dissipate heat faster. They require no modifications for installation. Pans include drain plug, fluid pick up extension, when required, pan gasket and new bolts and washers. 2-quart extra capacity.

All TH400.....	#13036.....	\$179.95/ea.
All TH350.....	#13037.....	\$185.95/ea.
All 700R4.....	#13038.....	\$199.95/ea.



TRANSMISSION OIL PAN

We offer two styles of transmission oil pans to match your vehicle. All pans have a ribbed pattern making these parts real beauties. Flawless chrome plating produces a transmission pan that's smooth and brilliant. Fluid is easily changed through the chrome drain plug, included with each pan.

All 700R4 w/o Logo	#2288	\$20.95/ea.
--------------------------	-------------	-------------



ARP STAINLESS TRANSMISSION PAN BOLTS

All 12-Pt, TH350/400	#14031	\$31.95/set
----------------------------	--------------	-------------

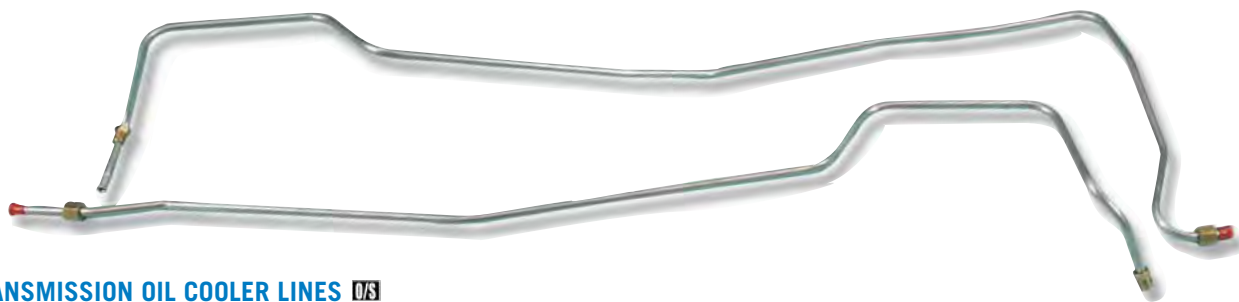

TRANSMISSION OIL COOLER LINES 0/8

As with our fuel and brake lines, our transmission oil cooler lines are reproduced to original specifications with correct contours and dimensions. **Note:** 200-4R and 700R4 applications may require slight bending on the transmission side. If your car has a stock 6-cylinder core support, use our #1597 transmission oil cooler lines. If using a stock V8 core support, use our #1551 lines. Cooler line clips included.

1955-57 6-Cyl. Powerglide	#1548.....	\$53.95/set
1955-56 V8 Powerglide.....	#1549.....	\$44.95/set
1957 V8 Powerglide	#1550.....	\$44.95/set
1957 V8 Turboglide	#1598.....	\$41.95/set
1955-57 SB, TH350/400, Engine Side of Core Support (Shown).....	#1551.....	\$44.95/set
1955-57 SB, TH350/400, Grille Side of Core Support.....	#1597.....	\$53.95/set
1955-57 BB, TH350/400 (Shown)	#2191.....	\$44.95/set
1955-1957 700R4 6-Cyl. Position.....	#19140.....	\$44.95/set
1955-1957 700R4 V8 Position	#19141.....	\$44.95/set



HEAT SINK STYLE TRANSMISSION COOLERS

These all aluminum two-pass Heat Sink cooler kits use both external and internal fins to maximize heat transfer. They are 3-inch in diameter with the inlet and outlet ports on the same end. Kit comes with a complete transmission cooler hardware kit to easily install onto vehicles with 5/16-inch transmission cooler lines, making it a perfect solution for light duty transmission cooling needs.

All 12" (Shown).....	#19464.....	\$89.95/kit
All 15".....	#19465.....	\$94.95/kit



TCI TRANSMISSION COOLER

TCI's transmission cooler is a must-have for any transmission. Measures 15-1/2-inch x 7-1/2-inch x 3/4-inch. 18,000 GVW rating.

All Universal.....	#13219.....	\$64.95/ea.
--------------------	-------------	-------------



TRANSMISSION OIL COOLER MOUNT KIT

All.....	#13464.....	\$11.95/kit
----------	-------------	-------------

TRANSMISSION OIL COOLER LINE CLIPS

The only way to hold your new transmission oil cooler lines in position is with these correct clips.



1955-57	#1552.....	\$3.95/pr.
---------------	------------	------------

TRANSMISSION OIL COOLER LINE FITTINGS

1955-57	#034.....	\$9.95/pr.
---------------	-----------	------------





DERALE STACKED PLATE TRANSMISSION COOLER KITS

With Deraled's top of the line 10000 Series stack plate cooler, -6AN aluminum fittings and hose barb adapters, this highly efficient kit extends transmission life by preventing heat-related transmission failures while also improving shifting performance. This kit comes with a complete transmission cooler hardware kit to easily install onto vehicles with 5/16-inch transmission cooler lines.

All 10-Row	#18490.....	\$104.95/kit
All 16-Row	#18491.....	\$129.95/kit
All 19-Row	#18492.....	\$149.95/kit

TRANSMISSION COOLER



DERALE STACKED PLATE SCOOP COOLER

Deraled Performance's Scoop Cooler is another industry exclusive, using Ram Air technology to force-feed air to their highly-efficient 10-Row stack plate cooler. As expected from the Deraled team, it can be used for a wide variety of cooling needs from engine and transmission to power-steering and fuel. Featuring a unique mounting bracket that sandwiches the cooler and the intake scoop, there are a wide variety of mounting options, all of which are designed to provide a clean, attractive and highly efficient cooler. Cooler equipped with 7/8-inch-14 (-10AN) inlet/outlets. -6 AN available, but sold separately.

All 10-Row	#18484.....	\$149.95/ea.
-------------------------	--------------------	---------------------

DERALE STACKED PLATE COOLER BRACKETS

Pair of single stacked plate brushed aluminium brackets. Kit includes fastener hardware.

All Single	#18489.....	\$64.95/pr.
-------------------------	--------------------	--------------------

Pair of dual stacked plate brushed aluminium brackets. For use when installing two coolers side-by-side. Kit includes fastener hardware.

All Dual	#18488.....	\$77.95/pr.
-----------------------	--------------------	--------------------



DERALE PLATE AND FIN TRANSMISSION COOLER KITS

Very popular with original equipment manufacturers for use on their towing applications, our plate and fin coolers feature strong furnace-brazed construction, 1-1/4-inch wide plates and embossed turbulators which maximize heat transfer while also minimizing pressure drop. It greatly extends transmission life by preventing heat-related transmission failures. Built with 1/2-inch NPT female cooler ports and includes 1/2-inch NPT x 3/8-inch hose barb adapters. This kit comes with a complete transmission cooler hardware kit to easily install onto vehicles with 5/16-inch transmission cooler lines.

All 5-Row	#18493.....	\$79.95/kit
All 9-Row	#18494.....	\$82.95/kit
All 13-Row	#18495.....	\$84.95/kit



DERALE STACKED PLATE COOLER ADJUSTABLE BRACKETS

Set of full length black powdercoated mounting brackets for use with Derale stacked plate cooler line. Kit includes bolts, nuts and washers.

All.....	#18487.....	\$39.95/pr.
----------	-------------	-------------



DERALE STACKED PLATE COOLER BRACKET KIT

Set of four black powder coated mounting brackets for use with Derale stacked plate cooler line. Unique design allows four plane mounting and kit includes bolts, nuts and washers.

All.....	#18486.....	\$18.95/kit
----------	-------------	-------------



DERALE STACKED PLATE COOLER FITTING

Cooler fittings for Derale fluid coolers.

All -6AN-10AN.....	#18485.....	\$10.95/ea.
--------------------	-------------	-------------

Transmission

MILODON STAINLESS TRANSMISSION DIPSTICKS

These transmission dipsticks have a unique sleek design. The fittings, stick and hose are all stainless steel and the o-ring sealed handle is billet stainless as well so they stay bright and rust free even with daily use. The stainless dipstick is pre-calibrated with the required "Add" and "Full" levels. Can be mounted to either firewall or transmission bell housing. **Made in the USA.**

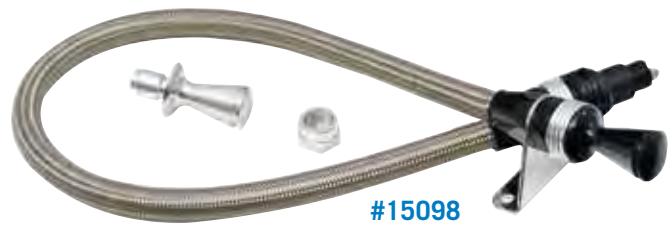
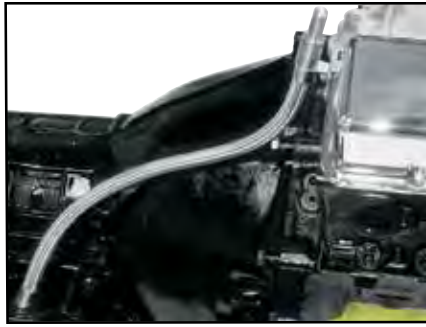

LOKAR ANCHOR-TIGHT LOCKING TRANSMISSION DIPSTICKS

Anchor-Tight dipstick assemblies are NHRA accepted and feature a locking mechanism to eliminate dipstick blowout under transmission pressure. The flexible tube also has a bolt-in sealed case fitting to prevent leaks even further and the larger filler tube accepts standard funnels so there's no need to carry around an adapter.

- All TH350/400, Black #15098..... \$153.95/ea.
- All 700R4, 3" Firewall Mount, Silver #16228..... \$169.95/ea.
- All 200-4R, 3" Firewall Mount, Silver #16229..... \$169.95/ea.

DIPSTICKS

- All TH350..... #12801..... \$110.95/ea.
- All TH400..... #12802..... \$104.95/ea.
- All 700R4..... #12803..... \$104.95/ea.

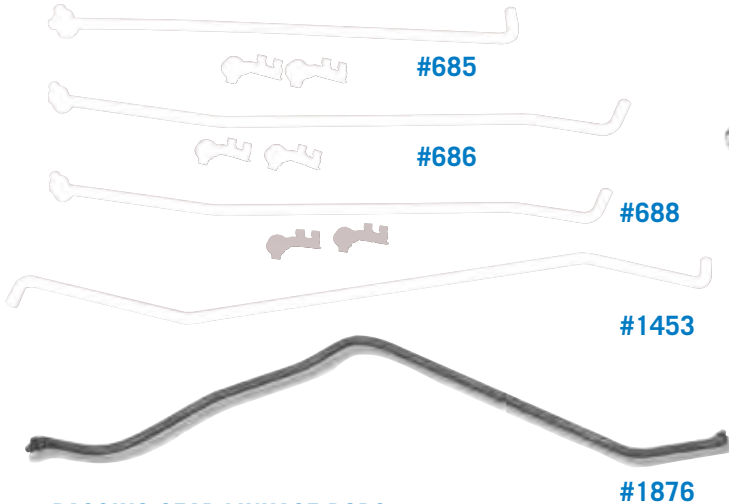

CHROME TRANSMISSION OIL DIPSTICKS

- All TH350..... #1977..... \$11.95/ea.
- All TH400..... #1978..... \$11.95/ea.

PASSING GEAR LINKAGE RODS

- 1955-56 Upper, V8 2BC, 9-1/2" ... #685..... \$24.95/set
- 1955-56 Upper, V8 4BC, 10-3/4" . #686..... \$24.95/set
- 1957 V8 Upper, 2BC, 11-1/2" #687..... \$24.95/ea.
- 1957 V8 Upper, 4BC, 12-5/8" #688..... \$24.95/set
- 1955-57 Upper, 6-Cyl., 12-3/4" ... #1453..... \$24.95/ea.
- 1955 Upper, Early Model 4BC, 7-1/2" #2199..... \$24.95/set
- 1955-56 Lower (Shown) #1876..... \$34.95/ea.
- 1957-62 Lower..... #1884..... \$16.95/ea.



LOCKING TRANSMISSION DIPSTICK AND TUBE

- All Chevy Engine, 200-4R..... #16975..... \$49.95/ea.

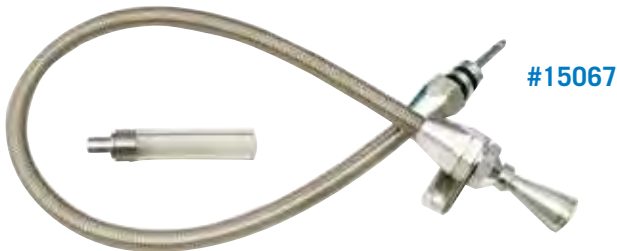

#15067

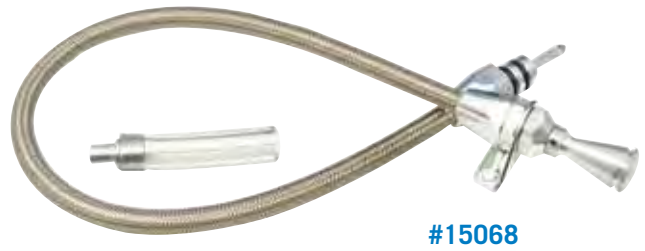

#15068



#15069



#16286



CLOSE UP

LOKAR HI-TECH TRANSMISSION DIPSTICKS

You can have unlimited flexibility with the teflon-lined flexible braided stainless transmission dipstick. Kit comes complete with braided stainless outer housing and heat resistant E-Z to Read Teflon inner rod. Inner rod is stamped with appropriate transmission fluid levels. Machined aluminum handle and aluminum fittings compliment Lokar's flexible engine dipstick. Firewall mount is recommended for 55-56-57's. Designed for "push-in" style transmission. Kit includes complete instructions.

All TH350/400, Firewall Mount.....	#11260.....	\$108.95/ea.
All TH350, Transmission Mount.....	#11261.....	\$101.95/ea.
All TH400, Transmission Mount.....	#11263.....	\$101.95/ea.
All 700R4, Firewall Mount.....	#11264.....	\$108.95/ea.
All 700R4, Transmission Mount.....	#11265.....	\$101.95/ea.
All 200-4R Firewall Mount.....	#14155.....	\$108.95/ea.
All Aluminum Powerglide, Firewall Mount.....	#11266.....	\$101.95/ea.
All Aluminum Powerglide Only, Trans. Mount.....	#11267.....	\$101.95/ea.
All 4L60, Firewall Mount.....	#15067.....	\$108.95/ea.
All 4L60E, Firewall Mount.....	#15068.....	\$108.95/ea.
All 4L80E, Firewall Mount.....	#15069.....	\$108.95/ea.
All LS 1997 & Later SB.....	#15070.....	\$75.95/ea.
All TH350/400, Firewall Mount, Black.....	#16286.....	\$118.95/ea.
All 700R4, Firewall Mount, Black.....	#16287.....	\$118.95/ea.
All 200-4R, Firewall Mount, Black.....	#16288.....	\$118.95/ea.



LOKAR BILLET DIPSTICK HANDLES WITH INNER CABLES

Replaces the loop on the end of your engine or transmission dipsticks. Complete with double o-rings and an E-Z-Read flexible inner cable. Will NOT work with Anchor-Tight dipsticks.

All 9-Ball.....	#18813.....	\$20.95/ea.	All Deco.....	#18818.....	\$20.95/ea.
All Bullet.....	#18814.....	\$20.95/ea.	All Solid Round.....	#18819.....	\$20.95/ea.
All Keg.....	#18815.....	\$20.95/ea.	All 8-Ball.....	#18820.....	\$20.95/ea.
All Shift Lever.....	#18816.....	\$20.95/ea.	All Piston.....	#18821.....	\$20.95/ea.
All Venetian.....	#18817.....	\$20.95/ea.			



ENGINE STARTER PLATE

If you want to put a TH350/400 transmission in your 1955-56 with a 265 V8 and would like to continue using the stock starter, then this is just what you'll need. Requires 168 tooth flex plate. 1957's will require '55-'56 style starters. Will also work with 700R4 and 200-4R transmissions. Note: Can also be used on 1957 with broken starter mounts.

Made in the USA.

1955-56 #10100..... \$159.95/ea.



SPEEDOMETER GEARS

This gear goes on the speedo drive that gets inserted into the transmission and are color coded. Match color to original. For use with original powerglides and 3-speed transmissions only.

1955-56 Red w/ 21 Teeth, Powerglide

..... #15542..... \$11.95/ea.

1957 Blue w/ 20 Teeth, Automatic

..... #15543..... \$11.95/ea.

1955-57 White w/ 25 Teeth, 3-Speed w/ Overdrive

..... #15545..... \$11.95/ea.

1955-57 Green w/ 22 Teeth, 3-Speed except Overdrive

..... #15544..... \$11.95/ea.

SPEEDOMETER SENSOR LEADS

If you are looking for a speedometer sensor plug for your late model overdrive conversion, look no further.



All 700R4..... #13678..... \$18.95/ea.

All 4LE60/4LE80..... #13679..... \$18.95/ea.

All 4L60..... #13680..... \$18.95/ea.

SPEEDOMETER CONVERTER

The Dakota Digital Electronic Cable Drive allows the use of a mechanical-cable speedometer to be used in conjunction with a modern drivetrain which provides only an electronic output. Quiet operation from the powerful motor allows the user to place the module inside the cabin or the waterproof case allows it to be mounted under the hood, or even inside a fenderwell. Simple calibration with a remotely-mounted switch means there are no DIP-switches to hassle with; access to ECD module is not required! Industry-standard 'measured-mile' calibration as well as speed adjustment while driving, based on a GPS or other known-speedometer reading, keep setup ultra simple.



All Electronic Signal-Cable Drive

..... #18676..... \$304.95/ea.

SPEEDOMETER CABLE WITH CASING

A heavy duty casing with threaded ends protects this well made cable. GM made this replacement cable and casing a bit longer than the original, but it functions identically. Fits most standard and auto transmissions.



1955-57 #228..... \$63.95/ea.

SPEEDOMETER CABLE

This is a replacement cable and does not include casing. It's a bit longer than the original, but easy-to-follow instructions make installation a snap. Fits both standard and automatic transmissions.



1955-57 #227..... \$31.95/ea.



TURBO HYDRA-MATIC SHIFT LINKAGE KIT

Here's what you need to keep stock steering column shifting when converting to the TH350 or 400. Proper contours correctly follow the floor and work in conjunction with our transmission conversion kit. Plated hardware and a powder coated finish make this linkage resistant to rust and corrosion, and as beautiful to look at as it is to operate. **Made in the USA.** See part #11283, above right, for overdrive transmissions.

1955-57 TH350/400 #952.....\$32.95/kit



ADJUSTABLE COLUMN SHIFT LINKAGE ARM KIT

All TH350/400, 700R4, 200-4R ... #11283.....\$58.95/kit



#2358A



#2359



#2358



#2359A

SHIFT DETENTS

These shift detents make using your stock style steering column with your new, or existing, transmission a breeze. Our #2358 and #2359 cover any applications that are using the original "Powerglide" and #2358A and #2359A cover later model transmissions like the TH350 on up to the 700R4. **Made in the USA.**

1955-56 Powerglide..... #2358..... \$18.95/ea.

1955-56 TH350/400, 700R4, 200-4R
..... #2358A..... \$18.95/ea.

1957 Powerglide #2359..... \$18.95/ea.

1957 TH350/400, 700R4, 200-4R #2359A..... \$18.95/ea.



SHIFT INDICATOR WIRE RODS

These reproductions are made with original gauge wire, and all bends and contours are accurate . . . that's quality you can rely on.

1955-56 Auto..... #936..... \$6.95/ea.

1957 Auto (Shown)..... #936A..... \$5.50/ea.



SHIFT LINKAGE ADJUSTMENT SWIVEL NUT

Automatic transmissions require one, while standards require two.

1955-57 #1175..... \$10.95/ea.

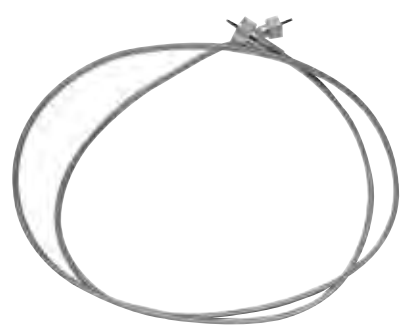

SPEEDOMETER CABLE WITH SPIRAL HOUSING

1955-57 70" #17418..... \$17.95/ea.

SHIFT COLUMN LEVER LINKAGE BUSHING

Just a little wear on this important bushing and your shift linkage will feel sloppy. Replacing this bushing will solve the problem and may spare you from more repairs.



1955-57 #1178..... \$6.95/ea.

Transmission



#15416

SHIFT LINKAGE HARDWARE KITS

1955-57 3-Speed Standard..... #15415.....\$18.50/kit
 1955-57 Auto Powerglide #15416.....\$19.95/kit

CLUTCH RELATED



#2262

#12035

#17147

SHIFT LINKAGE RETAINING CLIP

1955-70 #2262.....\$1.50/ea.

SHIFT LINKAGE BELL CRANK BUSHING

Two required per car.

1955-57 #12035.....\$2.50/ea.

DETENT SLIDE BUMPER

This snaps into a hole on the shift arm and contacts the back of the shift detent for smoother shifting. For automatic applications only.

1955-57 Auto Trans..... #17147.....\$3.50/ea.

TRANSMISSION LINKAGE GROMMETS

These are rubber linkage grommets in the bell crank area of the transmission linkage. Replacing these rubber parts will help to reduce the play in the shift linkage.



1955-57 Standard #1792.....\$4.95/set

CLUTCH PEDAL CROSS SHAFT SPACER

This small ring fits on the end of the clutch pedal cross shaft and acts as a spacer between the cross shaft sleeve and splined bellcrank arm.



1955-57 #16982.....\$3.95/ea.

CLUTCH PEDAL SHAFT BUSHING

Two bushings per car needed. Also fits 1964-72 Chevilles. **Made in the USA.**



1955-57 #352.....\$3.95/ea.

Just because your car is 60 years old you don't have to settle for a clutch that will not operate smoothly. Virtually all the necessary parts to completely rebuild your clutch linkage are available from Danchuk Manufacturing. Inspect your clutch assembly closely and give us a call.

1955 CLUTCH LINKAGE

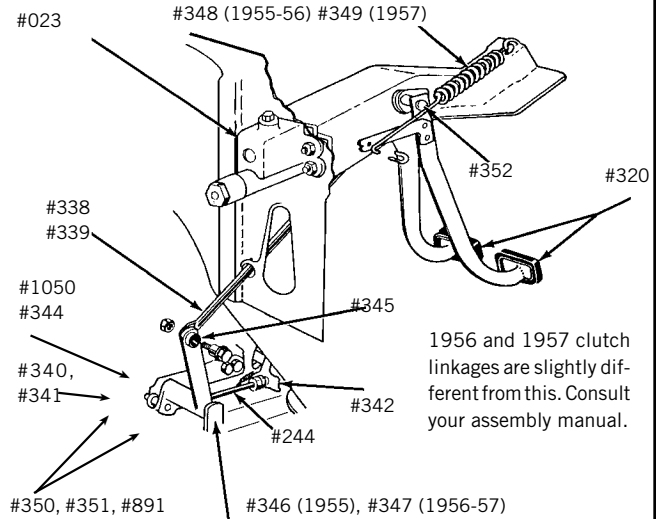

CLUTCH PEDAL CROSS SHAFT SLEEVE

This part is the sleeve which fits through the brake/clutch pedal housing.

1955-57 #16983.....\$15.95/ea.



CLUTCH PEDAL REBOUND BRACKET AND STOPPER

1955-56 #12577.....\$9.95/kit



CLUTCH PEDAL SPLINED OUTPUT ARM

1955-57 #12578.....\$15.95/kit



HEAVY DUTY CLUTCH PEDAL SHAFT

This heavy duty clutch pedal splined shaft replaces your original and really beefs up your clutch pedal. No more stripped splines.

1955-57 Splined Shaft..... #19300..... \$39.95/ea.



HEAVY DUTY CLUTCH PEDAL OUTPUT ARM

This is a heavy duty improved version of our #12578.

1955-57 Splined Lever #19301..... \$17.95/ea.



CLUTCH ROD KIT

Another great part from Danchuk. We made sure these parts were not only dimensionally correct but spared no expense on materials. The rod connects the clutch arm to the cross shaft. **Technical Note:** This kit and the clutch fork, part #342, on page 526, work together to replace early 1955 threaded clutch rods.

1955-57 #244..... \$23.95/kit



CLUTCH FRAME BRACKETS WITH PIVOT STUDS

1955..... #346..... \$18.95/ea.

1956-57 #347..... \$18.95/ea.



CLUTCH PEDAL RODS

Exact reproductions of the originals.

1955-56 #338..... \$13.95/ea.

1957..... #339..... \$13.95/ea.

BRAKE AND CLUTCH PEDAL BUMPER



This is a reproduction of the original for 1955 and 1956 models; it's an excellent functional replacement for the 1957.

Made in the USA.

1955-57 #818..... \$4.95/ea.



CLUTCH RELEASE BEARING

1955-57 #006..... \$62.95/ea.

#344



#1050

CLUTCH CROSS SHAFTS

Exact reproductions of the originals.

1955..... #1050..... \$33.95/ea.

1956-57 #344..... \$28.95/ea.

CLUTCH CROSS SHAFT BUSHING KIT



Everything about our clutch cross shaft bushing is custom. The bolt is turned from raw stock, case-hardened and plated with black oxide to protect it from rust. We've specified a bright plated, corrosion-resistant lock nut that features a nylon insert to hold it in place. The heart of the bushing kit are the two bushings, custom-made of Delrin, a high-tech material designed to provide smoother movement and greater durability.

Made in the USA.

1955-57 #345..... \$16.95/kit



CLUTCH CROSS SHAFT FELT WASHER



These install at either end of the clutch cross shaft to help keep dirt out and grease in around the pivot studs. Two are needed per car. **Made in the USA.**

1955-57 #891 \$2.95/ea.



FELT FLOOR SEAL

This installs inside the car under the steering column seal between it and the firewall seal. The clutch pedal rod goes thru this.

1955-57 Standard Transmission... #867..... \$6.95/ea.





LOWER BELL HOUSING COVER

1955-59 Standard, V8 #14951 \$39.95/ea.



CLUTCH BELL HOUSING BRACKETS WITH PIVOT STUDS

1955..... #340..... \$26.95/ea.

1956-57 (Shown) #341 \$26.95/ea.



CLUTCH PIVOT STUDS

1955..... #350..... \$16.95/ea.

1956-57 #351..... \$16.95/ea.



ANTI-RATTLE CLUTCH LINKAGE SPRING

1955-57 #12331 \$1.50/ea.



FLYWHEEL DUST COVER

This triple chrome plated flywheel dust cover will add the finishing touch to your engine/transmission installation. Some trimming may be necessary when using large starters.

All TH350/400 w/ 2-7/8" Starter Slot

..... #2277 \$23.95/ea.



CLUTCH FORK

Made from the original GM tooling these are an exact reproduction of the originals. A Danchuk exclusive.

1955-57 & '55-62 Vette #342..... \$74.95/ea.

ADJUSTABLE GM BELL HOUSING CLUTCH FORK PIVOT

This adjustable pivot ball allows you to adjust the clutch fork/throwout bearing assembly for proper alignment. Adjusts from a minimum of 1-5/16-inch to a maximum of 1-11/16-inch. Bell-housing side threads are 13/16-inch x 16. Equivalent to GM 5503855.

All..... #19463..... \$19.95/ea.



CLUTCH BELL HOUSING BOOTS

Beautiful reproduction of the leather bell housing boots with retainer for the 55-57's.

1955-56 #197A..... \$21.95/ea.

1957..... #197..... \$21.95/ea.

#349



#348

CLUTCH PEDAL RETURN SPRINGS AND HANGERS

These complete kits are made with high-quality spring steel, manufactured to duplicate angles and dimensions of the original part. **Made in the USA***.

1955-56 Best..... #348* \$31.95/set

1955-56 Good..... #16772..... \$15.95/set

1957..... #349* \$31.95/set



DELUXE CLUTCH PEDAL UPGRADE KITS

The clutch pedal upgrade kit is the cure for stripped clutch pedal shaft to actuator arm problems, common to original equipment. The partially splined shaft in the pedal U-clamped arm is replaced with a fully splined shaft and a heavy-duty splined indexable arm. The kit includes clutch pedal with shaft installed, a redesigned clutch return spring bracket, weld on spring anchor tab, return spring, 4130 chrome moly push rod with heim joints, reworked cross shaft, lower linkage, clutch fork, pivot brackets, felt washers and all necessary bushings and grade 8 hardware.

1955-56	#15899	\$599.95/kit
1957	#15899A	\$599.95/kit



OE CLUTCH PEDAL KITS

Contains everything but the clutch pedal pad (part #320 on page 152). With this kit your linkage is almost 100% new!

1955-56	#1180	\$94.95/kit
1957 (Shown)	#1181	\$94.95/kit



BASIC CLUTCH PEDAL UPGRADE KITS

Includes pedal and arm only.

1955-56	#15900	\$245.95/kit
1957 (Shown)	#15900A	\$245.95/kit

LOKAR FLOOR MOUNT SHIFTERS

The exclusive floor mount brackets allow for installation above or below the floor on the transmission tunnel. Kits include splined shift arms with three optional offset arms for mounting to right or left. Removal of the transmission is not necessary. Floor mount shifter is equipped with the expected safety features of a Lokar shifter. Requires the use of rectangular shifter boots.



- All TH350, 12" #18394..... \$259.95/ea.
- All TH400, 12" #18395..... \$259.95/ea.
- All 700R4, 12" #18396..... \$259.95/ea.
- All 200-4R, 12" #18397..... \$259.95/ea.
- All 4L60, 12" #18398..... \$259.95/ea.
- All 4L60E, 12" #18399..... \$259.95/ea.
- All 4L80E, 12" #18400..... \$259.95/ea.

LOKAR FLOOR MOUNT SHIFTERS, BENCH BEND WITH KNOBS

The exclusive floor mount brackets allow for installation above or below the floor on the transmission tunnel. Kit includes splined shift arm with three optional offset arms for mounting to right or left. Removal of the transmission is not necessary. The Bench Bend shifter arm is designed to help clear the factory bench seats.

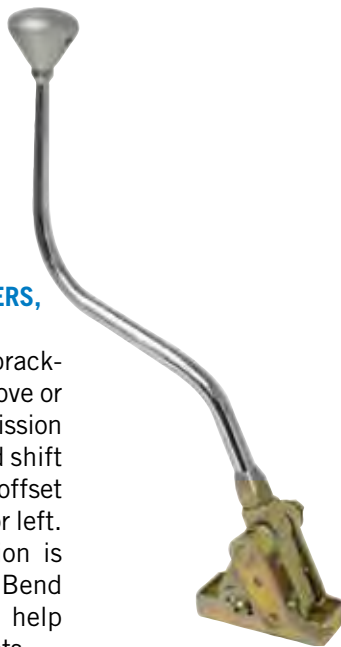

- All TH350, 16" #16841..... \$308.95/ea.
- All TH400, 16" #16842..... \$308.95/ea.
- All 700R4, 16" #16843..... \$308.95/ea.
- All 4L60, 16" #16844..... \$308.95/ea.
- All 200-4R, 16" #16845..... \$308.95/ea.
- All 4L60E, 16" #17402..... \$308.95/ea.



LOKAR LED BOOT INDICATOR WITH SENSOR KITS

Lokar's cable operated LED shift indicator sensor is designed for the flexibility to mount it in a variety of locations under the hood such as on the transmission, attached to the frame rail, to the floor pan, on the firewall or on the inner fender well. Remote mounting kit available for those out of the way, distant locations inside the vehicle, such as under the dash, behind the seat or in the trunk. Note: Round boot kits don't clear Lokar's floor mount shifters.

- All TH350/400, Round #16848..... \$283.95/kit
- All 700R4 & 200-4R, Round..... #16849..... \$283.95/kit
- All TH350/400, Rectangular..... #16850..... \$294.95/kit
- All 700R4 & 200-4R, Rectangular #16851..... \$294.95/kit



LOKAR MUSCLE CAR SHIFT KNOB ADAPTERS

Enjoy the look and feel of a classic Muscle Car Shifter on your Lokar shifter by installing this muscle car shift knob adapter. This shifter will give you the same "pull up to shift" tactile feel as the early Corvette but engineered for your updated Lokar shifter. Kit includes a shifter knob and installation instructions.

- All Black #18725..... \$76.95/ea.
- All Bright..... #18726..... \$76.95/ea.
- All White..... #18727..... \$76.95/ea.



LOKAR SHIFTER BOOTS WITH BILLET RINGS

Lokar boot kits include a rectangular or round billet ring with a ball milled edge, stainless screws and a black naugahyde boot. Note: Round boot kits do not clear Lokar's floor mount shifters.

- All Rectangular w/ Black Boot #16852..... \$77.95/ea.
- All Round w/ Black Boot..... #16853..... \$68.95/ea.



LOKAR DELUXE TOP SHIFTER BOOTS WITH SLIDING BEZELS

With Lokar's deluxe top rectangular boots with O-Ring sliding boot bezels, the boot can be placed anywhere along the length of the shifter lever allowing a portion of the lever to be exposed. O-ring sliding boot bezels are available separately to upgrade your existing shifter boot.

- All 5/8", Rectangular Boot w/ Aluminum Bezel #18388..... \$31.95/ea.
- All 5/8", Rectangular Boot w/ Chrome Bezel #18389..... \$36.95/ea.
- All 5/8", Rectangular Boot w/ Black Bezel #18390..... \$31.95/ea.
- All 5/8", Round Boot w/ Aluminum Bezel #18391..... \$31.95/ea.
- All 5/8", Round Boot w/ Chrome Bezel #18392..... \$36.95/ea.
- All 5/8", Round Boot w/ Black Bezel #18393..... \$31.95/ea.



LOKAR 2-INCH SHIFT KNOBS

Plain button shifter knobs are for use on Lokar shifters. Others are universal. 3/8-24 Thread.

- All Round, Satin..... #17511..... \$36.95/ea.
- All Round, Black..... #17512..... \$36.95/ea.
- All Venetian Polished..... #17516..... \$50.95/ea.
- All Round, Satin, Plain Button..... #17517..... \$39.95/ea.
- All Round, Black, Plain Button..... #17518..... \$39.95/ea.
- All Round Polished, Plain Button... #17519..... \$52.95/ea.
- All Round, Polished..... #17513..... \$50.95/ea.
- All Venetian Satin #17514..... \$36.95/ea.
- All Venetian Black #17515..... \$36.95/ea.
- All Venetian Satin, Plain Button #17520..... \$39.95/ea.
- All Venetian Black, Plain Button ... #17521..... \$39.95/ea.
- All Venetian Polished, Plain Button #17522..... \$52.95/ea.
- All Deco, Satin, Plain Button..... #17523..... \$39.95/ea.
- All Deco, Black, Plain Button..... #17524..... \$39.95/ea.
- All Deco, Polished, Plain Button ... #17525..... \$52.95/ea.



LOKAR SLIDING BEZELS

- All 5/8", Aluminum #18385..... \$18.95/ea.
- All 5/8", Chrome..... #18386..... \$23.95/ea.
- All 5/8", Black #18387..... \$18.95/ea.

LOKAR SHIFTER KNOB ADAPTERS

While personal style is important, at Lokar, "safety is never an extravagance". To fill the void between personal preference and personal safety, Lokar developed a shifter knob adapter which allows you to express yourself with highly custom knobs, yet still retain all of the safety features and benefits of a Lokar Shifter, including the positive lock-out in park and neutral. The adapter is offered with common 3/8-16 or 3/8-24 thread sizes.



- All 3/8-16 Knob #16846 \$35.95/ea.
- All 3/8-24 Knob #16847 \$35.95/ea.

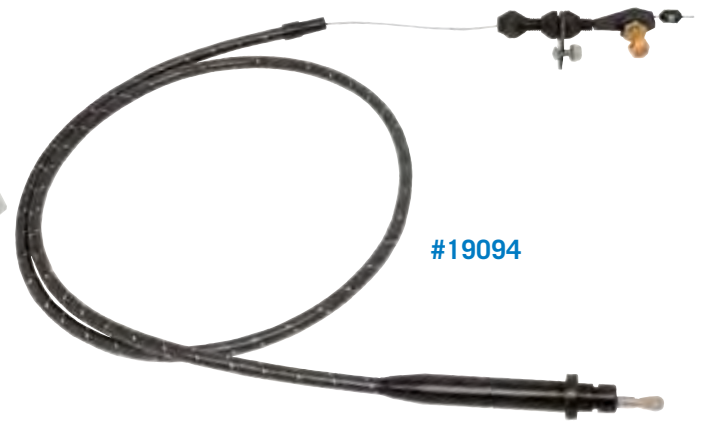

#19094

LOKAR VINTAGE SERIES THROTTLE CABLES

- All Black/White, 24" #19085 \$67.95/ea.
- All Black/Blue, 24" #19086 \$67.95/ea.
- All Black/Red, 24" #19087 \$67.95/ea.
- All Black/White, 36" #19088 \$76.95/ea.
- All Black/Blue, 36" #19089 \$76.95/ea.
- All Black/Red, 36" #19090 \$76.95/ea.
- All Black/White, 36", LS1 #19091 \$76.95/ea.
- All Black/Blue, 36", LS1 #19092 \$76.95/ea.
- All Black/Red, 36", LS1 #19093 \$76.95/ea.



THROTTLE/VALVE/UNIVERSAL CABLE

- All 700R4 & 200-4R #16969 \$64.95/ea.



OVERDRIVE WIRE HARNESS SWITCH PLUG

This new overdrive connector plug holds the four wires that plug onto the kick down switch on the carburetor.
 1955-68 #18935 \$21.95/ea.



#16970



#16971



#16972



#16973

THROTTLE/VALVE CABLE BRACKETS

TV brackets for the 700R4 and 200-4R. All are carb mount except #16970, which is a manifold mount.

- All Holley Carb/Manifold Mount #16970 \$31.95/ea.
- All QuadraJet Carb #16972 \$39.95/ea.
- All Holley Carb #16971 \$41.95/ea.
- All Edelbrock Carb #16973 \$54.95/ea.

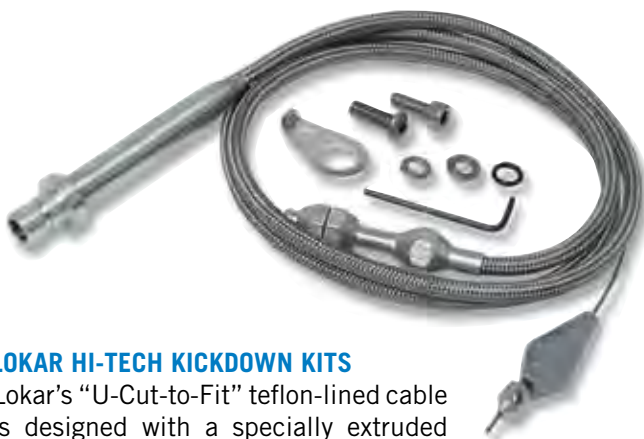

LOKAR HI-TECH KICKDOWN KITS

Lokar's "U-Cut-to-Fit" teflon-lined cable is designed with a specially extruded liner for extended life of the cable. Kick-down features aluminum fittings with ferrule to eliminate frayed cable ends. Kickdowns are adaptable for all types of manifolds. Mount the kickdown with the stainless steel carburetor bracket and return springs. Complete instructions included in the kit.

- All TH350, Braided Stainless..... #12025.....\$109.95/kit
- All TH350 Tuned Port, Braided Stainless
..... #12026.....\$109.95/kit
- All 700R4, Braided Stainless..... #12028.....\$109.95/kit
- All 700R4 Tuned Port, Braided Stainless
..... #12029.....\$109.95/kit
- All 200-4R, Braided Stainless #14154.....\$99.95/kit
- All TH350, Black #16281.....\$105.95/ea.
- All 700R4, Black #16282.....\$105.95/ea.
- All 200-4R, Black #16283.....\$105.95/ea.

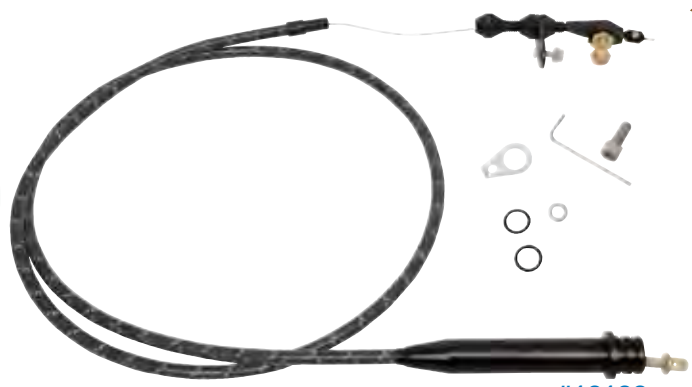

#19100

LOKAR VINTAGE SERIES KICKDOWN CABLES

- All Black/White, TH350..... #19094..... \$104.95/ea.
- All Black/Blue, TH350..... #19095..... \$104.95/ea.
- All Black/Red, TH350..... #19096..... \$104.95/ea.
- All Black/White, TH400..... #19097..... \$116.95/ea.
- All Black/Blue, TH400..... #19098..... \$116.95/ea.
- All Black/Red, TH400..... #19133..... \$116.95/ea.
- All Black/White, 700R4..... #19099..... \$104.95/ea.
- All Black/Blue, 700R4..... #19100..... \$104.95/ea.
- All Black/Red, 700R4..... #19101..... \$104.95/ea.



LOKAR ELECTRIC KICKDOWN KIT

Lokar's TH400 electric kickdown is cable operated. Electric switch is housed in a billet aluminum box that mounts with the transmission pan bolts. This design eliminates mounting unsightly electrical switches on the carburetor, manifold or near the gas pedal.

- All..... #12027.....\$106.95/kit



OVERDRIVE KICKDOWN BRACKETS

This bracket attaches to the carburetor and holds the overdrive kick down switch. The actuator attaches to the throttle lever. Use with Carter WCFB # 2218S 4-bbl carburetor..

- 1955 2218S..... #18936.....\$124.95/pr.



KICKDOWN CONNECTOR

Molded connector for TH400 GM transmission kickdown which is located on the side of the transmission.

- All TH400..... #12348..... \$13.95/ea.



TRANSMISSION KICKDOWN STUD

- 1986 & Up TH350 #13354..... \$6.95/ea.



LOKAR STAINLESS KICKDOWN BRACKET AND CABLE

Standard adjustable GM detent with Lokar's stainless mounting bracket mounts onto the two back manifold bolts. Designed for 4-barrel-type carburetors for small block Chevs. Kit includes extender for more versatility in adjusting cable length where needed.

All TH350..... #12024..... \$56.95/ea.



NEUTRAL SAFETY/BACK-UP LIGHT SWITCH ASSEMBLIES

These complete assemblies are for use on the TH350 and 400 transmissions. All necessary mounting hardware and connectors are included.

1955-57 TH350 #1345..... \$115.95/ea.

1955-57 TH400 (Shown) #1346..... \$115.95/ea.

STAINLESS KICKDOWN BRACKET

This mounts on the driver side of the engine on the two rear intake manifold bolts.

All TH350..... #11268..... \$28.95/ea.



THROTTLE/KICKDOWN CABLE BRACKETS

This bracket, when used with Lokar throttle cables, will allow the Ramjet 350 to work properly in any vehicle. When using this bracket with an automatic transmission be sure to order the correct transmission specific Lokar kickdown cable.

All Stainless, TH350 Ramjet..... #13015..... \$75.95/ea.



NEUTRAL SAFETY BACK-UP LIGHT SWITCHES

Without this important part, your car won't start. Part #035 will also work for TH350/400, 200-4R and 700R4 applications on 57 columns as a bolt in and on 55-56 columns with minor modification.

1955-56 Powerglide..... #1104..... \$26.95/ea.

1957 Powerglide..... #1105..... \$26.95/ea.

1957 Turboglide (Fits '64-'66)..... #035..... \$17.95/ea.



TRANSMISSION KICKDOWN LEVER ASSEMBLY

1955-56 Middle, V8 #15440..... \$29.95/ea.



NEUTRAL SAFETY OR BACK-UP LIGHT SWITCH KIT

This kit offers the choice of back-up light switch or neutral safety switch kit. Kit fits TH350, TH400, TH700R4, TH2004R, 4L60, 4L60E and 4L80E transmissions. Single trigger for back-up light switch, or double trigger for neutral safety switch. KIT NOT INTENDED TO FUNCTION AS BOTH. All mounting hardware included. Works with Lokar and may work with others.

All Auto #15880..... \$41.95/kit



12. Sheet Metal

SECTION AT A GLANCE:

Front End Sheet Metal Components.....	534
Hood Assemblies	536
Headlight.....	540
Filler Panels.....	541
Radiator.....	542
Splash Shields	545
Fenders	546
Firewall	552
Cowl Panels	554
Rocker Panels	556
Pillar Panels.....	558
Doors.....	560
Seat Back Braces	563
Door Related	564
Diagrams	566
Complete Floors	568
Full Length Floor Pans	570
Trunk Floors.....	571
Complete Floor & Trunk.....	572
Floor Braces.....	574
Floor Pans	576
Toe Boards.....	578
Trunk Patch Panels.....	579
Trunk to Quarter Patch Panels.....	580
Trunk Splash Panels	581
Trunk Assemblies.....	582
Quarter Panels	584
Roof	590
Tailgate.....	592
TailPans.....	594
Cargo Floor	595
Wheel Housing.....	597
Convertible	600
GM Licensed Bodies	602
Anti-Squeak, Seals & Mounts.....	604

1955 FRONT END SHEET METAL LAYOUT



1955 FRONT END SHEET METAL COMPONENTS

1955 Hood Assembly w/ Holes	#16128		\$529.95/ea.
1955 Front Filler Panels, 3-Piece	#12253		\$199.95/set
1955 Inner & Outer Fender Assemblies w/o Apron, Driver	#16879		\$729.95/pr.
1955 Inner & Outer Fender Assemblies w/o Apron, Passenger	#16880		\$729.95/pr.
1955 Radiator Core Support Side Filler Panels, Driver, Black	#16049		\$22.95/ea.
1955 Radiator Core Support Side Filler Panels, Passenger, Black	#16050		\$22.95/ea.
1955 Radiator Core Supports w/ Upper Bars, 6-Cylinder	#16040		\$239.95/ea.
1955 Radiator Core Supports w/ Upper Bars, V8	#16041		\$239.95/ea.

1957 FRONT END SHEET METAL LAYOUT



1957 FRONT END SHEET METAL COMPONENTS

1957 Hood Assembly.....	#16129			\$649.95/ea.
1957 Full Fender, Driver, 210 & Bel Air	#1357			\$479.95/ea.
1957 Full Fender, Passenger, 210 & Bel Air.....	#1358			\$479.95/ea.
1957 Full Fender, Driver, 150, No Holes	#1359			\$479.95/ea.
1957 Full Fender, Passenger, 150, No Holes.....	#1360			\$479.95/ea.
1957 Fender Support to Cowl Brackets	#17233			\$34.95/pr.
1957 Front Filler Panel	#1342			\$249.95/ea.
1957 Radiator Core Support Side Filler Panels, Driver.....	#17892			\$21.95/ea.
1957 Radiator Core Support Side Filler Panels, Passenger	#17893			\$21.95/ea.
1957 Front, Inner Fenders, Driver	#16135			\$269.95/ea.
1957 Front, Inner Fenders, Passenger.....	#16136			\$269.95/ea.
1957 Front Splash Shields, Driver, 13" x 12".....	#16087			\$87.95/ea.
1957 Front Splash Shields, Passenger, 13" x 12".....	#16088			\$87.95/ea.
1956-57 Lower Front Radiator Splash Shields, Driver, Black.....	#16051			\$89.95/ea.
1956-57 Lower Front Radiator Splash Shields, Passenger, Black	#16052			\$89.95/ea.



1955 HOOD ASSEMBLY  
1955 w/ Holes..... #12401..... \$749.95/ea.



1955 HOOD ASSEMBLY  
1955 w/ Holes..... #16128..... \$529.95/ea.



1955 "SMOOTHIE" STYLE HOOD ASSEMBLY  

1955..... #17908..... \$599.95/ea.



1956 HOOD ASSEMBLIES  

1956 Original	#18922.....	\$599.95/ea.
1956 "Smoothie" Style	#18923.....	\$629.95/ea.



1955 HOOD BAFFLE BRACE  

1955.....	#16214.....	\$88.95/ea.
-----------	-------------	-------------



1957 HOOD BAFFLE BRACE  

1957.....	#15215.....	\$89.95/ea.
-----------	-------------	-------------



1957 CUSTOM HOOD BAFFLE BRACE  

Allows use of 1955-56 center outlet 6-cylinder radiators. Ideal for long water pumps or big block applications.

1957.....	#18304.....	\$94.95/ea.
-----------	-------------	-------------



1957 HOOD ASSEMBLY  
1957 w/ Holes.....

#14637..... \$799.95/ea.



1957 HOOD ASSEMBLY  
1957 w/ Holes.....

#16129..... \$649.95/ea.

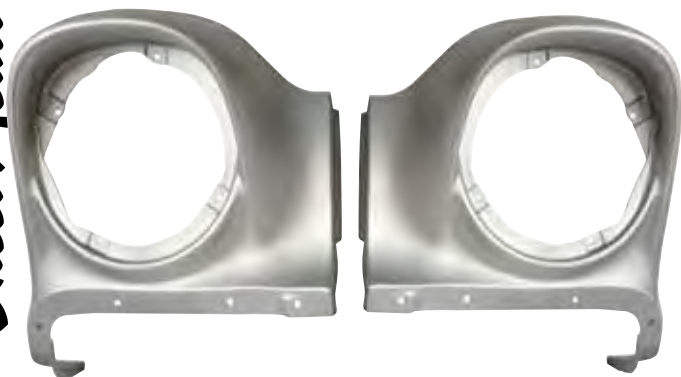

1956 FRONT FENDER HEADLIGHT PATCH PANELS 
 1956 Driver..... #17203..... \$239.95/ea.
 1956 Passenger #17204..... \$239.95/ea.



 **1955 FRONT FENDER HEADLIGHT PATCH PANELS**
SHOW QUALITY
 Dimensions are 8-inch x 8-inch. **Made in the USA.**
 1955 Driver..... #10013..... \$99.95/ea.
 1955 Passenger #10014..... \$99.95/ea.



1956 FRONT FENDER HEADLIGHT PATCH PANELS 
 Dimensions are 7-inch x 5-inch. **Made in the USA.**
 1956 Driver..... #1365..... \$80.95/ea.
 1956 Passenger #1366..... \$80.95/ea.



 **1955 FRONT FENDER HEADLIGHT MOUNTING BRACKET**
 Fits both sides. Welds inside part #10013 and #10014 to support the headlight bucket. Measures 9½-inch x 2-inch x 5¾-inch. **Made in the USA.**
 1955..... #12409..... \$58.95/ea.



 **1956 FRONT FENDER HEADLIGHT INNER PATCH PANELS**
 Dimensions are 11-inch x 2-inch.
 1956 Driver #1367..... \$57.95/ea.
 1956 Passenger #1368..... \$57.95/ea.

#288
1957 SPLASH PAN SEALS

These rubber dust seals were installed at the outer edges the splash pan on both sides. The "C" edge slips up over the edge of the splash pan with the flap facing up and forward. It was originally stapled in four places on each side. It will be necessary to poke a hole in the outer edge so the outer splash pan to fender bolt may be installed.

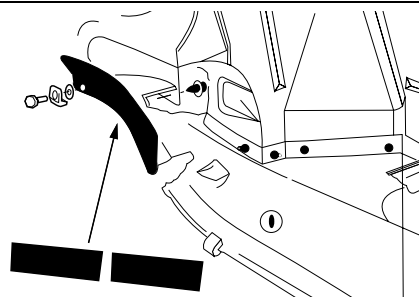



CHROME FRONT FILLER PANEL  **O/S**

1957..... #18719..... \$349.95/ea.



#12253



#1340



#1342

FRONT FILLER PANELS **O/S**

1955 3-Piece.....	#12253.....	\$199.95/set
1956	#1340.....	\$239.95/ea.
1957.....	#1342.....	\$249.95/ea.

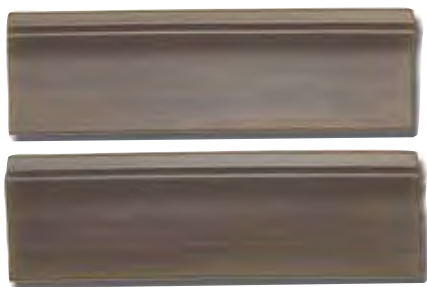

1957 FRONT SPLASH PAN SEALS 

These rubber dust seals were installed at the outer edges the splash pan on both sides to help protect your engine compartment from water and dirt. The "C" edge slips up over the edge of the splash pan with the flap facing up and forward. It was originally stapled in four places on each side. It will be necessary to poke a hole in the outer edge so the outer splash pan to fender bolt may be installed.

Made in the USA.

1957..... #288..... \$12.95/pr.



1955 RADIATOR SPLASH PAN CENTER SUPPORT BRACKET

Riveted to the splash pan for extra strength, the radiator splash pan center support bracket prevents the pan from sagging, keeping dirt and grime out of the engine compartment. Bolts or screws may be used as an alternative to rivets. This bracket also holds up the hood latch support.

Made in the USA.

1955 #2074..... \$27.95/ea.



#16043



#16047



#10015



#15214

RADIATOR CORE SUPPORTS WITH UPPER BARS O/S

These core supports are just what you need for a big block transplant, small block with a long water pump or an original restoration with a 6-cylinder or V8.

1955 6-Cyl.....	#16040.....		\$239.95/ea.
1956 6-Cyl.....	#16043.....		\$239.95/ea.
1957 6-Cyl.....	#16046.....		\$239.95/ea.
1955 V8.....	#15214.....		\$499.95/ea.
1955 V8.....	#16041.....		\$239.95/ea.
1956 V8.....	#16044.....		\$239.95/ea.
1957 V8.....	#16047.....		\$239.95/ea.
1955-57 V8 w/o Bar	#10015.....		\$599.95/ea.



RADIATOR STRAP ASSEMBLY

1955-57 V8 #10016..... \$199.95/ea.



CHROME RADIATOR SUPPORTS O/S

1955 6-Cyl.....	#18419.....	\$295.95/ea.
1956 6-Cyl. (Shown).....	#18420.....	\$289.95/ea.
1957 6-Cyl.....	#18421.....	\$289.95/ea.



RADIATOR CORE UPPER SUPPORT BARS O/S

Your front sheet metal won't line up properly if you don't have a straight core support.

1955 Bare.....	#11946.....	\$99.95/ea.
1955 Black.....	#16042.....	\$89.95/ea.
1955 Chrome.....	#18410.....	\$209.95/ea.
1956 Black.....	#16045.....	\$89.95/ea.
1956 Chrome.....	#18411.....	\$215.95/ea.
1957 Bare.....	#2034.....	\$98.95/ea.
1957 Black.....	#16048.....	\$89.95/ea.
1957 Chrome.....	#18412.....	\$209.95/ea.

RADIATOR



CHROME RADIATOR CORE SUPPORT KITS O/S

1956 6-Cyl.....	#18130.....	\$499.95/kit
1957 6-Cyl.....	#18131.....	\$499.95/kit
1956 V8 (Shown).....	#17611.....	\$499.95/kit

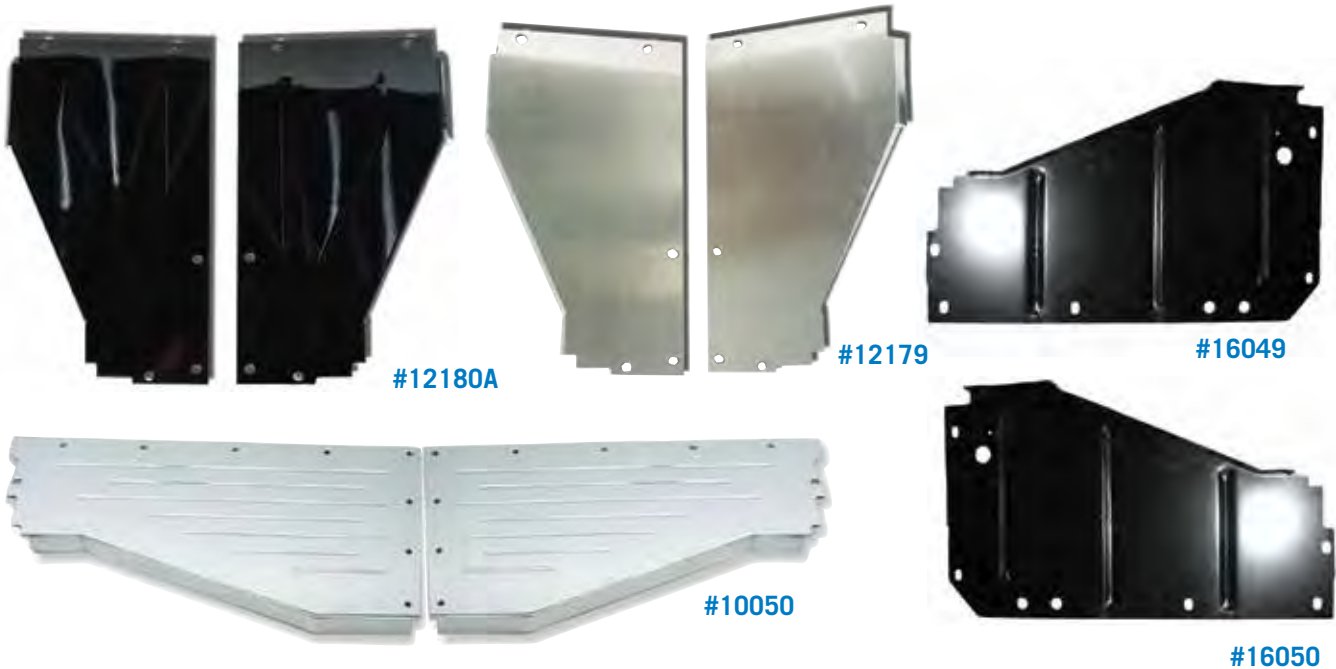

RADIATOR

RADIATOR CORE SUPPORT SIDE FILLER PANELS

Filling in between the radiator and the inner fender wall, these top-quality filler panels are a great way to help keep dirt and grime out of the engine compartment.

1955 Driver & Passenger, Second Design	#2093		\$49.95/pr.
1957 Driver.....	#1880		\$58.95/ea.
1957 Passenger	#1881		\$58.95/ea.
1955 Custom Smooth Aluminum, Plain.....	#12179		\$145.95/pr.
1956 Custom Smooth Aluminum, Plain.....	#12179A		\$145.95/pr.
1957 Custom Smooth Aluminum, Plain.....	#12179B		\$145.95/pr.
1955 Custom Smooth Steel, Plain, Bare	#12180		\$134.95/pr.
1956 Custom Smooth Steel, Plain, Bare	#12180B		\$134.95/pr.
1957 Custom Smooth Steel, Plain, Bare	#12180C		\$134.95/pr.
1955 Custom Smooth Steel, Plain, Black Powder Coat.....	#12180A		\$159.95/pr.
1956 Custom Smooth Steel, Plain, Black Powder Coat.....	#12180D		\$159.95/pr.
1957 Custom Smooth Steel, Plain, Black Powder Coat.....	#12180E		\$159.95/pr.
1955-56 Polished Aluminum w/ Lines	#10049		\$417.95/pr.
1957 Polished Aluminum w/ Lines	#10050		\$417.95/pr.
1955 Driver, Black.....	#16049		\$22.95/ea.
1955 Passenger, Black	#16050		\$22.95/ea.
1956 Driver, Black.....	#17890		\$21.95/ea.
1956 Passenger, Black	#17891		\$21.95/ea.
1957 Driver., Black.....	#17892		\$21.95/ea.
1957 Passenger, Black	#17893		\$21.95/ea.



#19049



RADIATOR CORE SUPPORT CENTER FILLER PANEL

This was only used on V8 applications.

1955-57 V8 #1895..... \$25.95/ea.

CHROME RADIATOR SUPPORT FILLER PANELS

1955..... #19048..... \$179.95/pr.
 1956..... #19049..... \$179.95/pr.
 1957..... #19050..... \$179.95/pr.

#16051



#16052



#2109



#2108

LOWER FRONT RADIATOR SPLASH SHIELDS

Attaches to the bottom edge of the inner fender behind the core support and fills the gap between the core support and the cross member. Measures 17¹/₂-inch x 1¹/₂-inch x 3¹/₄-inch.

1956-57 Driver.....	#2108.....		\$74.95/ea.
1956-57 Passenger.....	#2109.....		\$74.95/ea.
1956-57 Driver.....	#16051.....		\$89.95/ea.
1956-57 Passenger.....	#16052.....		\$89.95/ea.

#10017 & #10018



#1131 & #1132



#16085

#16086



#16087

#16088



SPLASH SHIELDS

Rear shields are the rear portion of the inner front fender which measure 15¹/₂-inch x 4-inch x 14¹/₂-inch, while the front splash shields fill the gap between the front edge of the inner fender, the front filler panel and outer fender just behind the grille and measure 11¹/₂-inch x 11¹/₂-inch x 6³/₄-inch.

1955 Rear, Driver	#10017.....		\$54.95/ea.
1955 Rear, Passenger.....	#10018.....		\$54.95/ea.
1955 Rear, Driver	#16085.....		\$69.95/ea.
1955 Rear, Passenger.....	#16086.....		\$69.95/ea.
1957 Front, Driver	#1131.....		\$98.95/ea.
1957 Front, Passenger.....	#1132.....		\$98.95/ea.
1957 Front, Driver	#16087.....		\$87.95/ea.
1957 Front, Passenger.....	#16088.....		\$87.95/ea.

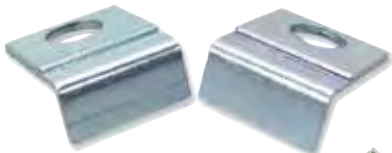

FRONT SPLASH PAN TO FENDER RETAINERS

These splash pan to fender retainers keep the corners of your splash pan and one end of the splash pan seal in place.

1957	#2252.....		\$9.95/pr.
------------	------------	--	------------

SEE SHIPPING INFORMATION ON PAGES 723-727 FOR EXPLANATIONS ON TRUCK FREIGHT AND OVERSIZED SHIPPING.

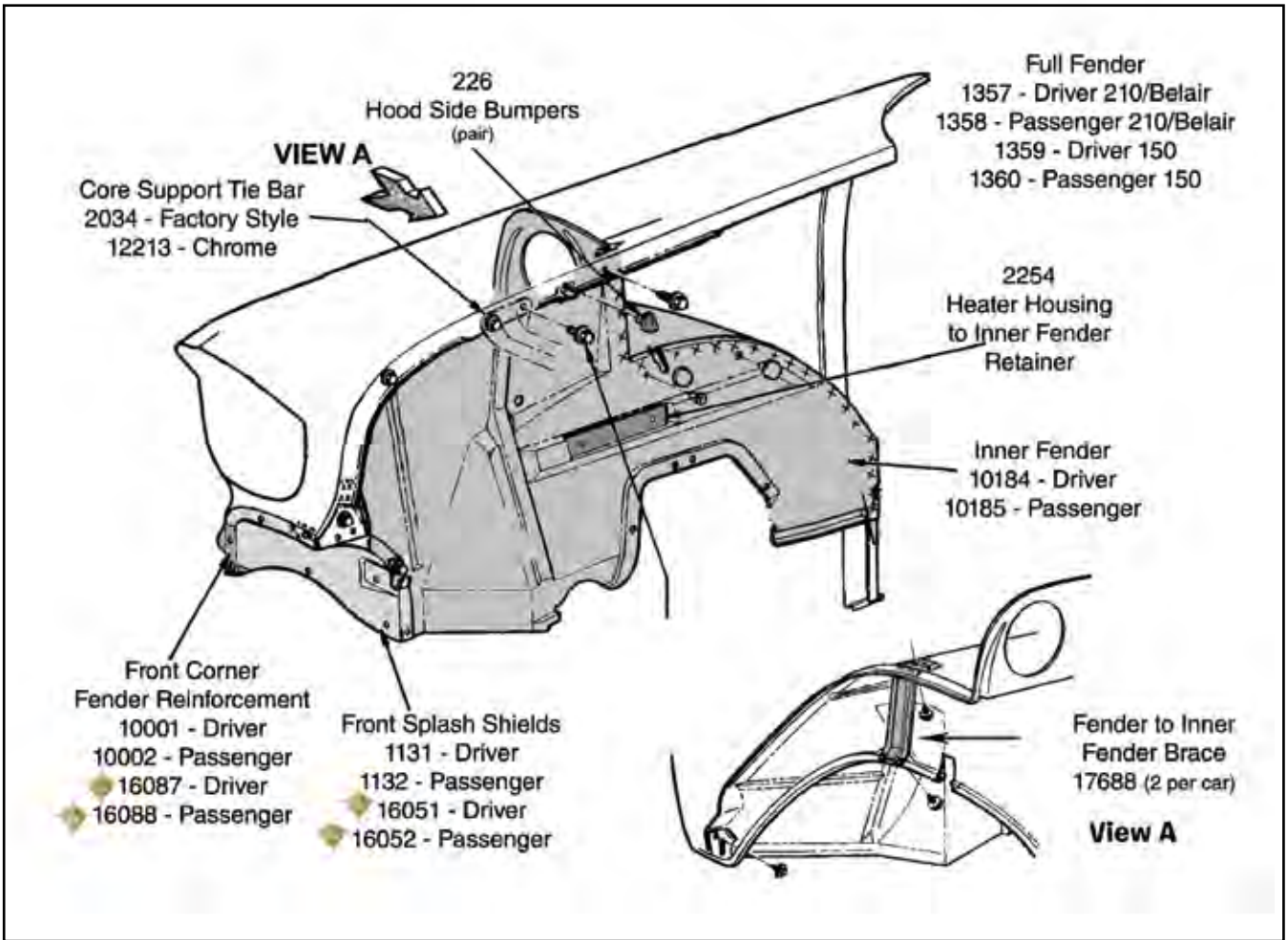
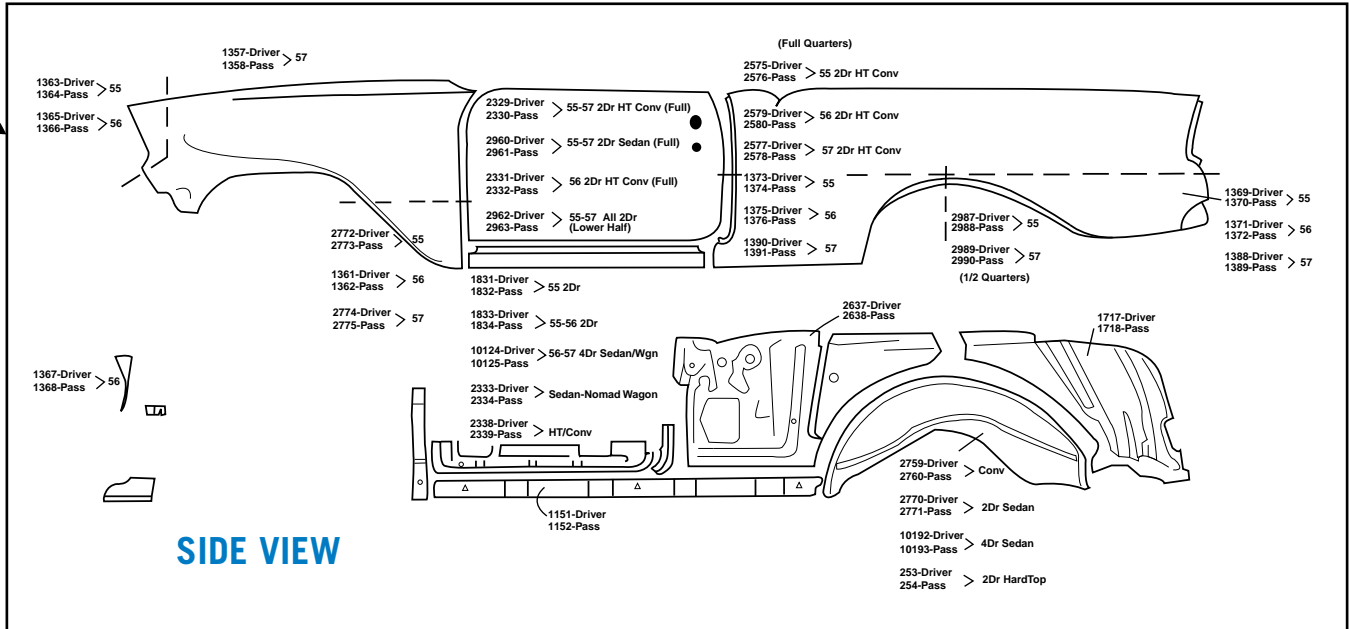



#18264





#18265



#1357

FULL FENDERS 

See page 549 for inner fenders.

1956 Driver.....		#18264.....	\$899.95/ea.
1956 Passenger.....		#18265.....	\$899.95/ea.
1957 Driver, 210 & Bel Air.....		#1357.....	\$479.95/ea.
1957 Passenger, 210 & Bel Air.....		#1358.....	\$479.95/ea.
1957 Driver, 150, w/o Holes.....		#1359.....	\$479.95/ea.
1957 Passenger, 150, w/o Holes.....		#1360.....	\$479.95/ea.



#16879



#16880

FENDERS





1955 INNER AND OUTER FENDER ASSEMBLIES WITHOUT APRON 

This part includes the inner and outer fender assembly.

1955 Driver.....	#16879.....	\$729.95/ea.
1955 Passenger	#16880.....	\$729.95/ea.



1956 LOWER INNER FRONT FENDER EXTENSIONS

1956 Driver.....	#15765 	\$88.95/ea.
1956 Passenger	#15766 	\$88.95/ea.
1956 Driver.....	#19419 	\$69.95/ea.
1956 Passenger	#19420 	\$69.95/ea.



1957 FENDER SUPPORT TO COWL BRACKETS 

This mounts at the top of the cowl at the rear of the fender and connects the fender to the cowl. One for each side, fits either side. **Made in the USA.**

1957.....	#17233.....	\$34.95/pr.
-----------	-------------	-------------

1955 FRONT FENDER TO UPPER COWL BRACKET 

This mounts at the top of the cowl at the rear of the fender and connects the fender to the cowl. One for each side, fits either side.

Made in the USA.

1955 Either Side	#15217.....	\$34.95/ea.
------------------------	-------------	-------------



#12832



#2072

INNER FENDER SUPPORT TO COWL BRACKETS 

The 1955-56 brackets attach to the lower cowl forward leg and secure the inner fender to the cowl leg. The 1957 mount on the top of the cowl at the back of the fender and secure the fender to the cowl. **Made in the USA.**

1955-56	#12823.....	\$21.95/pr.
1957	#2072.....	\$21.95/pr.

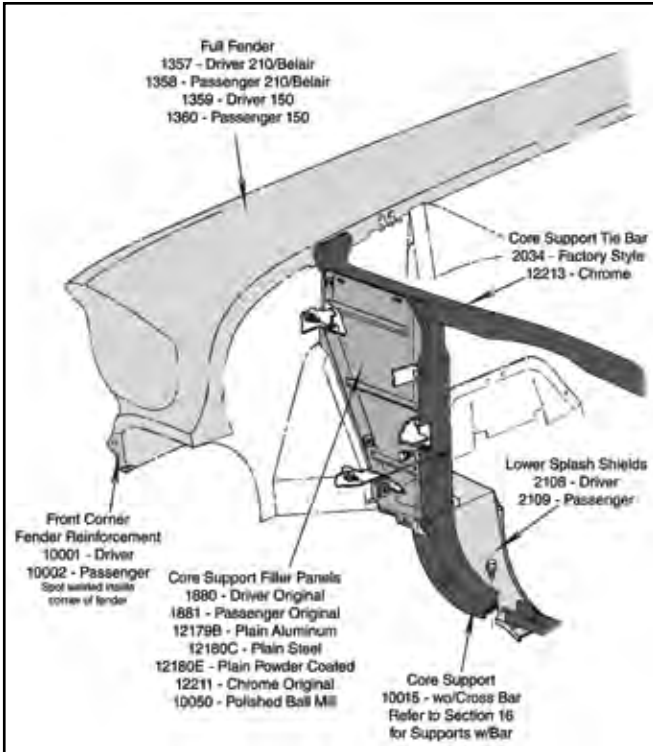

1957 FRONT FENDER TO INNER FENDER BRACE

This often overlooked item mounts between the front inner fender and fender at the inside fender lip and keeps the fender from shaking. Two needed per car. Fits both sides. 1957..... #17688..... \$16.95/ea.



FRONT INNER FENDERS

1955 Driver.....	#12372.....	\$189.95/ea.
1955 Passenger.....	#12373.....	\$189.95/ea.
1956 Driver.....	#17776.....	\$239.95/ea.
1956 Passenger.....	#17777.....	\$239.95/ea.
1957 Driver.....	#10184.....	\$418.95/ea.
1957 Passenger.....	#10185.....	\$418.95/ea.
1957 Driver.....	#16135.....	\$269.95/ea.
1957 Passenger.....	#16136.....	\$269.95/ea.

1957 FRONT FENDER REINFORCEMENT

This front fender reinforcement welds to the front fenders at the front bumper mounting point on both the driver and passenger sides. Measures 23 1/2-inch x 2 1/4-inch x 4-inch. 1957 Driver & Passenger..... #2998..... \$11.95/ea.



INNER FENDER WIRE HARNESS CLIPS



Made in the USA.

1955-57 #1006..... \$49.95/set

FENDERS



FRONT FENDER, LOWER REAR PATCH PANELS 

Dimensions for #2772 and #2773 are 18-inch x 15-inch; #1361 and #1362 are 18-inch x 16-inch; and #2774 and #2775 are 19-inch x 15½-inch. **Made in the USA.**

1955 Driver.....	#2772.....	\$104.95/ea.	1956 Passenger.....	#1362.....	\$88.95/ea.
1955 Passenger.....	#2773.....	\$104.95/ea.	1957 Driver.....	#2774.....	\$78.95/ea.
1956 Driver.....	#1361.....	\$88.95/ea.	1957 Passenger.....	#2775.....	\$78.95/ea.



FRONT FENDER REAR BRACES 

Located at the rear of the fender at the door. 1955 parts measure 23½-inch x 2¼-inch x 4-inch. 1957 parts measure 31-inch x 5-inch x 5-inch.

1955 Driver.....	#2994.....	\$89.95/ea.
1955 Passenger.....	#2995.....	\$89.95/ea.
1957 Driver.....	#2996.....	\$104.95/ea.
1957 Passenger.....	#2997.....	\$104.95/ea.



1955 FRONT FENDER SUPPORT BRACKETS 

This brace rivets to the fender lip in the wheel opening. Helps to secure fender lip to inner fender.

1955 Driver.....	#1893.....	\$58.95/ea.
1955 Passenger.....	#1894.....	\$58.95/ea.



PHOTO COURTESY OF GERTMAN2000

INNER FENDER SEALS 

Our fender seals are manufactured with rubber formulas that far outlast the original parts. These inner fender seals are an absolute must when replacing or repairing front fenders or inner fender wells. **Made in the USA.**



1949-56.....	#558.....	\$20.95/pr.
1957.....	#559.....	\$20.95/pr.



FENDER SKIRTS WITH BRACKETS

Seals available below.

1955 (Shown)	#385.....	\$157.95/pr.
1956 (Shown)	#389.....	\$138.95/pr.
1957.....	#380A.....	\$139.95/pr.



STAINLESS FENDER SKIRT SCUFF PADS

1955.....	#1032.....	\$22.95/pr.
1956 (Shown)	#1039.....	\$22.95/pr.
1957.....	#1043.....	\$22.95/pr.

FENDER SKIRT BRACKETS



Don't forget to re-
place the brackets when repainting and resealing those
old fender skirts. Fits all Foxcraft fender skirts. Set of four.

Made in the USA.

1955-64	#236.....	\$5.95/set
---------------	-----------	------------

REAR ACCESSORY FENDER-TO-FENDER SKIRT SEALS



All accessory fender skirts should be wrapped with these seals before installation to protect the paint finish on the fenders. Sold as a pair. **Made in the USA.**



1955-57	#554.....	\$11.95/pr.
---------------	-----------	-------------

#294



#295



#390



FENDER ANTI-SQUEAK GASKET KITS



These kits contain an assortment of specialized parts, each one die cut or extruded to exact specifications. Whether you are doing a front clip removal for an engine detail, or a complete frame-off restoration, this is the only way to totally eliminate front end body panel squeaks. **Made in the USA.**

1955.....	#294.....	\$16.95/kit
1956.....	#390.....	\$21.95/kit
1957.....	#295.....	\$18.95/kit

#857



HOOD ANTI-SQUEAK GASKET KITS



These kits are die cut to exact specifications and are necessary to prevent the hood panels from squeaking.

Made in the USA.

1955-56	#857.....	\$8.95/kit
1957.....	#391.....	\$10.95/kit

FIREWALL



#16090

FIREWALLS  

What a work of art these sought after parts are. These firewalls are all there top to bottom with the toe boards and stamped in one piece just like GM did it! The firewall to frame braces are in place and the kick panel retainers are attached, including all captive nuts.

1955-56	#16089.....	\$599.95/ea.
1957.....	#16090.....	\$599.95/ea.



FIREWALL COVERS 

Smooth your firewall with these panels for a clean look. Welding required. **Made in the USA.**

1955-56	#12181.....	\$258.95/ea.
1957.....	#12182.....	\$258.95/ea.



PHOTO COURTESY OF GERTMAN2000



 FIREWALL BRACES

1955-56	#19152.....	\$219.95/pr.
1957.....	#19153.....	\$219.95/pr.



SMOOTHIE FACTORY FIREWALL 🚗 ⚡

Reproduction of the original firewall with all the small holes inboard of the hood hinges removed. Great for customs and right hand drive conversions. The holes removed are: heater box, heater valve, wiper motor, gas pedal, steering column, clutch rod, and master cylinder holes have been eliminated. Includes firewall and main cowl braces with forward body mount point.

1955-56	#17961	\$599.95/ea.
1957	#16888	\$599.95/ea.



#15468



#19299

REPLACEMENT SMOOTH FIREWALL PANELS 📏

1957 will require trimming.

1955-57 w/ 4-inch Setback	#15468	\$489.95/ea.
1955-57 w/ 4-inch Setback, Custom Curved	#19299	\$499.95/ea.

1957 REALDUCTION FIREWALL DUCT BLOCK-OFF PANELS

These block-off panels allow you to easily and cleanly remove the fresh air ducts from the inner fender. Made from sturdy 18-gauge steel and powder coated black, the firewall block off plates cover the holes in the firewall and install with your original sheet metal screws. The front fender block off insures that your front headlight buckets will install just like when the fresh air ducts were there.



1957 Firewall Plates Only	#18643	\$47.95/pr.
1957 w/ Fender Block-Off (Shown)	#18644	\$154.95/pr.



COMPLETE DASH PANEL **O/S** 

1957..... #18969..... \$649.95ea.

COWL PANELS



1957 UPPER COWL PANEL WITH WINDSHIELD FLANGE **O/S** 

This beautiful part covers the entire bottom of the windshield! It goes from the top of the firewall to the front of the dash panel. Included is the lower glass drains, cutouts for the defroster ducts and cutouts for the wipers.

1957 Upper..... #16057..... \$469.95/ea.



UPPER COWL PANEL WITH WINDSHIELD FLANGE **T/F** 

1955-56 #17433..... \$469.95/ea.



LOWER COWL PANEL **O/S** 

1955-56 #16651..... \$374.95/ea.



WINDSHIELD VISORS O/S

These reproduction sheet metal visors capture the trend of the times and add a retro touch to your classic Chevy.

- 1955-57 Sedan & Wagon..... #18446..... \$599.95/ea.
- 1955-57 Hardtop & Nomad #18447..... \$649.95/ea.



COWL VENT GRILLE PANEL O/S

This smoothie style cowl vent grille panel is just the thing for giving the area under the windshield a little jazzing up.

- 1955-56 Smoothie Style #19291..... \$129.95/ea.

#12658



#16058



1955-56 OUTER COWL SIDE PANELS

This piece replaces cowl side panels in front of door hinge area. Dimensions are 24-inch x 7-inch x 10¹/₂-inch.

- 1955-56 Driver..... #12658 \$84.95/ea.
- 1955-56 Passenger..... #12659 \$84.95/ea.
- 1955-56 Driver..... #16055 \$79.95/ea.
- 1955-56 Passenger..... #16056 \$79.95/ea.

#16059



1957 COWL SIDE PANELS

These are very nice and complete pieces including the threaded inserts.

- 1957 w/ A-Pillar Section, Driver.. #16058..... \$79.95/ea.
- 1957 w/ A-Pillar Section, Passenger
..... #16059..... \$79.95/ea.



1957 OUTER COWL SIDE PANELS

This piece replaces cowl side panels in front of door hinge area. Measures 24-inch x 3¹/₂-inch x 9-inch. **Made in the USA.**

- 1957 Driver..... #12136..... \$68.95/ea.
- 1957 Passenger #12137..... \$68.95/ea.



1957 COWL SIDE EXTENSION HINGEMOUNTS

Located in front cowl area where the door hinge attaches. Measures 27-inch x 5¹/₂-inch x 3¹/₂-inch. **Made in the USA.**

- 1957 Driver..... #12140..... \$78.95/ea.
- 1957 Passenger #12141..... \$78.95/ea.

ROCKER PANELS



#17384

#17385

#17386

#17387

#17782

#17783



#16881

#16882

#16883

#16884

#16885

#16886

FACTORY STYLE, 4-DOOR OUTER ROCKER PANELS

1955 Sedan/Wagon, Driver	#17782.....	\$144.95/ea.
1955 Sedan/Wagon, Passenger....	#17783.....	\$144.95/ea.
1956 Sedan/Wagon, Driver	#17384.....	\$149.95/ea.
1956 Sedan/Wagon, Passenger....	#17385.....	\$149.95/ea.
1956 Hardtop, Driver	#17387.....	\$149.95/ea.
1956 Hardtop, Passenger.....	#17386.....	\$149.95/ea.
1957 Sedan/Wagon, Driver	#17380.....	\$149.95/ea.
1957 Sedan/Wagon, Passenger.....	#17381.....	\$149.95/ea.
1957 Hardtop, Driver	#17382.....	\$149.95/ea.
1957 Hardtop, Passenger.....	#17383.....	\$149.95/ea.

FACTORY STYLE, 2-DOOR ROCKERS WITH FENDER BRACKETS

These factory style outer rockers include the front fender bracket and endcaps already installed.

1955 Driver.....	#16881.....	\$99.95/ea.
1955 Passenger	#16882.....	\$99.95/ea.
1956 Driver.....	#16883.....	\$119.95/ea.
1956 Passenger	#16884.....	\$119.95/ea.
1957 Driver.....	#16885.....	\$119.95/ea.
1957 Passenger	#16886.....	\$119.95/ea.

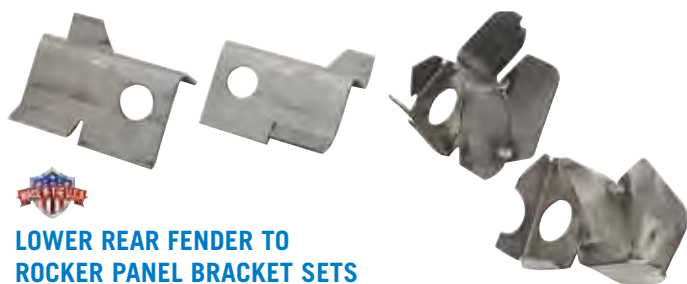

LOWER REAR FENDER TO ROCKER PANEL BRACKET SETS

4-piece set that includes the rocker panel end caps.

Made in the USA.

1955 (Shown)	#15033.....	\$99.95/ea.
1956	#15034.....	\$99.95/ea.
1957	#15035.....	\$99.95/ea.



1957 OUTER FRONT ROCKER PANEL INSERTS

Outer rocker panel front insert welds to the inside of the outer rocker panel. Made in the USA.

1957 Driver	#2966.....	\$43.95/ea.
1957 Passenger	#2967.....	\$43.95/ea.

1955 LOWER REAR FENDER TO ROCKER MOUNT BRACKETS

This is the fender to rocker mounting bracket that connects the bottom of the fender to the front of the rocker panel. Measures approx. 3¹/₂-inch x 3-inch.

1955 Driver.....	#15310.....	\$33.95/ea.
1955 Passenger	#15311.....	\$33.95/ea.



ROCKER PANEL PLUGS

These install in the bottom of the rocker between the B-pillar and the rear wheel opening on 2-Door models and about the center of the rear door on 4-door models. Made in the USA.

1955-57	#826.....	\$8.95/pr.
---------------	-----------	------------





#1831-1832



#2975



#2974

#10124



#10125



ROCKER PANELS  **O/S**

Our rocker panels are factory reproductions, (with the exception of part #2970-2977) featuring the same structural backside flanging found on the original parts.

Dimensions for #1831-1834 are 46-inch x 4-inch x 3¹/₂-inch. Fits 2-Door hardtop and wagons, sedan, convertible, and Nomads. Parts #2970-2977 are replacement patch panel caps only. Be sure to order rocker panel brackets #15033 - #15035 to complete the job. **Made in the USA.**

1955 2-Door, Driver (Shown).....	#1831.....	\$104.95/ea.
1955 2-Door, Passenger (Shown).....	#1832.....	\$104.95/ea.
1956-57 2-Door, Driver.....	#1833.....	\$104.95/ea.
1956-57 2-Door, Passenger.....	#1834.....	\$104.95/ea.
1956-57 4-Door Sedan & Wagon, Driver.....	#10124.....	\$158.95/ea.
1956-57 4-Door Sedan & Wagon, Passenger.....	#10125.....	\$158.95/ea.
1955 2-Door, Replacement Cap, Driver.....	#2970.....	\$56.95/ea.
1955 2-Door, Replacement Cap, Passenger.....	#2971.....	\$56.95/ea.
1955 4-Door, Replacement Cap, Driver.....	#2972.....	\$64.95/ea.
1955 4-Door, Replacement Cap, Passenger.....	#2973.....	\$64.95/ea.
1956-57 2-Door, Replacement Cap, Driver (Shown).....	#2974.....	\$56.89/ea.
1956-57 2-Door, Replacement Cap, Passenger.....	#2975.....	\$56.95/ea.
1956-57 4-Door, Replacement Cap, Driver.....	#2976.....	\$64.95/ea.
1956-57 4-Door, Replacement Cap, Passenger.....	#2977.....	\$64.95/ea.



#1151 & #1152

#16176







#16177



INNER ROCKER PANEL BRACES  **O/S**

Installs between the bottom lip of the rocker panel and the floor. Measures 69-inch x 1-inch x 3¹/₂-inch.

1955-57 Driver.....	 #1151.....	\$64.95/ea.
1955-57 Passenger.....	 #1152.....	\$64.95/ea.
1955-57 Driver.....	 #16176.....	\$59.95/ea.
1955-57 Passenger.....	 #16177.....	\$59.95/ea.

SEE SHIPPING INFORMATION ON PAGES 723-727 FOR EXPLANATIONS ON TRUCK FREIGHT AND OVERSIZED SHIPPING.



A-PILLAR UPPER COWL SIDE REPAIR KITS

These five-piece kits will repair the upper cowl area and A-pillar starting just below the top door hinge all the way up to the complete windshield pillar and upper hinge post. 5-piece kit makes installation and repair much easier.

- 1955-56 2-Door Hardtop & Nomad, 1956 4-Door Hardtop, Driver..... #18740.....\$429.95/kit
- 1955-56 2-Door Hardtop & Nomad, 1956 4-Door Hardtop, Passenger #18741\$429.95/kit
- 1955-56 2 & 4-Door Sedan & Wagon, Driver #18742.....\$429.95/kit
- 1955-56 2 & 4-Door Sedan & Wagon, Passenger #18743.....\$429.95/kit
- 1955-56 Convertible, Driver..... #18744.....\$429.95/kit
- 1955-56 Convertible, Passenger . #18745.....\$429.95/kit
- 1957 2 & 4-Door Hardtop & Nomad, Driver #18746\$429.95/kit
- 1957 2 & 4-Door Hardtop & Nomad, Passenger #18747\$429.95/kit
- 1957 2 & 4-Door Sedan & Wagon, Driver #18748..... \$429.95/kit
- 1957 2 & 4-Door Sedan & Wagon, Passenger #18749.....\$429.95/kit
- 1957 Convertible, Driver..... #18750.....\$429.95/kit
- 1957 Convertible, Passenger #18751\$429.95/kit



A-PILLAR PARTIAL PANELS

These panels will repair from the curve at the bottom at the rocker panel up 18-inch into the A-pillar. **Made in the USA.**
 1955-56 Driver (Shown) #12266..... \$119.95/ea.
 1955-56 Passenger (Shown)..... #12267..... \$119.95/ea.
 1957 Driver..... #12268..... \$118.95/ea.
 1957 Passenger #12269..... \$118.95/ea.



A-PILLAR REINFORCEMENTS

Welds to lower inner cowl area below door hinge to reinforce the door hinge pillar.

- 1955-57 Driver..... #12134..... \$44.95/ea.
- 1955-57 Passenger #12135..... \$44.95/ea.
- 1955-56 Sedan, Hardtop & 1957 Conv., Driver #17566..... \$43.95/ea.
- 1955-56 Sedan, Hardtop & 1957 Conv., Passenger #17567..... \$43.95/ea.
- 1957 Sedan, Hardtop, Driver #17568..... \$44.95/ea.
- 1957 Sedan, Hardtop, Passenger . #17569..... \$44.95/ea.



A-PILLAR PANELS WITH COWL **O/S**

This repair panel covers the A-pillar to the outer cowl side and also the outer windshield post.

- 1955-56 2-Door Hardtop & Nomad, 1956 4-Door Hardtop, Driver #17899..... \$491.95/ea.
- 1955-56 2-Door Hardtop & Nomad, 1956 4-Door Hardtop, Passenger #17900..... \$491.95/ea.
- 1955-56 Convertible, Driver..... #17901..... \$491.95/ea.
- 1955-56 Convertible, Passenger .. #17902..... \$491.95/ea.
- 1955-56 2 & 4-Door Sedan & Wagon, Driver #17903..... \$491.95/ea.
- 1955-56 2 & 4-Door Sedan & Wagon, Passenger #17904..... \$491.95/ea.
- 1957 2 & 4-Door Hardtop & Nomad, Driver #18641..... \$491.95/ea.
- 1957 2 & 4-Door Hardtop & Nomad Hardtop, Passenger #18642..... \$491.95/ea.
- 1957 2 & 4-Door Sedan & Wagon, Driver #17905..... \$491.95/ea.
- 1957 2 & 4-Door Sedan & Wagon, Passenger #17906..... \$491.95/ea.
- 1957 Convertible, Driver #16516..... \$491.95/ea.
- 1957 Convertible, Passenger #16517..... \$491.95/ea.



CONVERTIBLE B-PILLAR BRACKETS

- Connects the B-pillar to the B-pillar brace. Measures 14¹/₂-inch x 1-inch x 2-inch. **Made in the USA.**
- 1955-57 Driver..... #1141..... \$31.95/ea.
- 1955-57 Passenger #1142..... \$31.95/ea.



UPPER B-PILLAR REINFORCEMENTS

- 1955-57 Sedan, Wagon & Sedan Del., Driver #16077..... \$204.95/ea.
- 1955-57 Sedan, Wagon & Sedan Del., Passenger #16078..... \$204.95/ea.



B-PILLAR FULL PANELS

Fits 2-door hardtop and convertibles. See below for convertible B-pillar braces. Dimensions are 27¹/₂-inch x 3¹/₂-inch x 7¹/₂-inch. **Made in the USA.**

- 1955-57 Driver #10116..... \$174.95/ea.
- 1955-57 Passenger #10117..... \$174.95/ea.

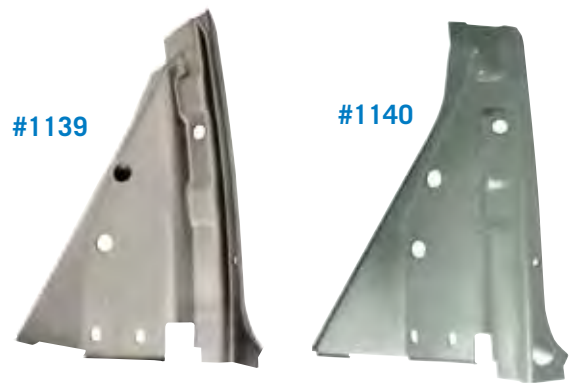















CONVERTIBLE B-PILLAR BRACES

Welds to the rear floor pan and the inner quarter just behind the door. Dimensions 17-inch x 3³/₄-inch x 12³/₄-inch. **Made in the USA.**

- 1955-57 Driver..... #1139..... \$158.95/ea.
- 1955-57 Passenger #1140..... \$158.95/ea.



COMPLETE DOORS 

1955 & 57 2-Door Hardtop, Driver.....		#12113.....	\$948.95/ea.
1955 & 57 2-Door Hardtop, Passenger		#12114.....	\$948.95/ea.
1955 & 57 Convertible, Driver.....		#12115.....	\$948.95/ea.
1955 & 57 Convertible, Passenger		#12116.....	\$948.95/ea.
1956 2-Door Hardtop, Driver		#12117.....	\$948.95/ea.
1956 2-Door Hardtop, Passenger.....		#12118.....	\$948.95/ea.
1956 Convertible, Driver.....		#12119.....	\$948.95/ea.
1956 Convertible, Passenger		#12120.....	\$948.95/ea.
1955-57 2-Door Sedan, Wagon & Sedan Delivery, Driver (Shown)		#16065.....	\$729.95/ea.
1955-57 2-Door Sedan, Wagon & Sedan Delivery, Passenger (Shown)		#16066.....	\$729.95/ea.
1955 & 57 2-Door Hardtop, Driver.....		#16067.....	\$729.95/ea.
1955 & 57 2-Door Hardtop, Passenger		#16068.....	\$729.95/ea.
1956 2-Door, Hardtop, Driver		#19383.....	\$729.95/ea.
1956 2-Door, Hardtop, Passenger.....		#19384.....	\$729.95/ea.
1955 & 57 Convertible, Driver.....		#16069.....	\$729.95/ea.
1955 & 57 Convertible, Passenger		#16070.....	\$729.95/ea.

#16079 OUTSIDE VIEW



#16081 OUTSIDE VIEW



#16068



#16067















#16070











#16069











FULL DOOR SKINS

1955 & 57 2-Door Hardtop & Conv., Driver, Show Quality		#2329		\$238.95/ea.
1955 & 57 2-Door Hardtop & Conv., Passenger, Show Quality		#2330		\$238.95/ea.
1956 2-Door Hardtop & Convertible, Driver, Show Quality		#2331		\$258.95/ea.
1956 2-Door Hardtop & Convertible, Passenger, Show Quality		#2332		\$258.95/ea.
1955 & 57 2-Door Sedan, Driver, Show Quality		#2960		\$248.95/ea.
1955 & 57 2-Door Sedan, Passenger, Show Quality		#2961		\$248.95/ea.

NOTE: Inside top rail must be re-used from original door.

1955 & 57 2-Door Hardtop & Conv., Driver, Driver Quality		#2956		\$199.95/ea.
1955 & 57 2-Door Hardtop & Conv., Passenger, Driver Quality		#2957		\$199.95/ea.
1956 2-Door Hardtop & Convertible, Driver, Driver Quality		#2958		\$229.95/ea.
1956 2-Door Hardtop & Convertible, Passenger, Driver Quality		#2959		\$229.95/ea.

1955 & 57 2-Door Hardtop, Convertible except 1956, Driver		#16079		\$232.95/ea.
1955 & 57 2-Door Hardtop, Convertible except 1956, Passenger		#16080		\$232.95/ea.
1955 & 57 2-Door Sedan, Wagon & Sedan Delivery, Driver		#16081		\$299.95/ea.
1955 & 57 2-Door Sedan, Wagon & Sedan Delivery, Passenger		#16082		\$299.95/ea.



COMPLETE NOMAD DOORS  

- 1955-57 Driver..... #18670..... \$699.95/ea.
- 1955-57 Passenger #18671..... \$699.95/ea.



SEAT BACK BRACE  

A beautiful piece! This large brace mounts behind the rear seat back between the rear wheel wells and the floor to the deck filler panel.

- 1955-57 2-Door Hardtop, Rear #16178..... \$239.95/ea.



CONVERTIBLE SEAT BACK BRACE PANEL  

- 1955-57 Rear..... #16652..... \$249.95/ea.



DOOR SKINS, LOWER HALF OF DOOR  **O/S**

Dimensions are 47¹/₂-inch x 23³/₄-inch.

1955-57 All 2-Door, Driver (Shown)	#2962	\$68.95/ea.
1955-57 All 2-Door, Passenger	#2963	\$68.95/ea.



CONVERTIBLE REAR SEAT FLOOR BRACKET

This seat bracket welds to the rear underseat floor pan on convertibles. Requires two per car.

1955-57	#16887	\$19.95/ea.
----------------------	---------------------	--------------------



REAR SEAT FLOOR MOUNTS 

1955-57 4-Door Wagon, Driver	#17390	\$52.95/ea.
1955-57 4-Door Wagon, Psngr	#17391	\$52.95/ea.

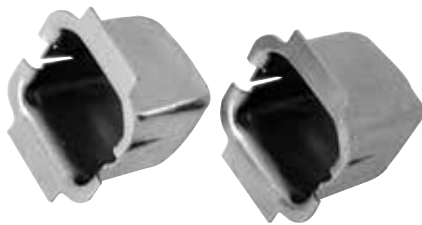

REAR SEAT FLOOR POCKETS 

These install into the rear floor underseat pan to retain the seat bottom.

1956-57 4-Door Hardtop, 1955-57 Sedan	#16893	\$20.95/pr.
---	---------------------	--------------------



PHOTO COURTESY OF GERTMAN2000



#2338

INNER SHEET METAL DOOR BOTTOMS  O/S

These will also work on 2-door sedans and wagons with minor modifications. Dimensions are 46-inch x 4¹/₄-inch x 8¹/₂-inch. **Made in the USA.**

- 1955-57 2-Door Hardtop & Convertible, Driver #2338..... \$158.95/ea.
- 1955-57 2-Door Hardtop & Convertible, Passenger #2339..... \$158.95/ea.



B-PILLAR LOWER PATCH PANELS 

Welds in between the outer skin and the inner quarter panel at the door jamb. Measures 13-inch x 4³/₄-inch x 5¹/₂-inch. Fits 2-door hardtops and convertibles.

- 1955-57 Driver..... #1235..... \$104.95/ea.
- 1955-57 Passenger #1236..... \$104.95/ea.



INSIDE DOOR HANDLE REINFORCEMENTS 

Spot welds on the inside door skin and provides support for the outside door handle. **Made in the USA.**

- 1955-57 #11332.....\$49.95/pr.



REAR SEAT DOOR PANEL RETAINERS

These retainers mount/weld to the inner quarter structure and provide a mounting point for the rear armrests.

- 1955-57 2-Door Hardtop & Convertible #16104.....\$13.95/pr.



#18302



#18303



#16892



#16262

REAR DOOR JAMB DOG LEG REPAIR PANELS

The rear door jamb dog leg to rocker panel repairs the rear bottom section of the rear door jamb where it meets the rocker. Parts #2698 and #2699 measure 23-inch high. Part #18302 and #18303 measures 14¹/₂-inch high. Parts #16261 and 16262 measures 19-inch high.

- 1955-57 4-Door Sedan & Wagon, Passenger #16262..... \$49.95/ea.
- 1956-57 4-Door Hardtop, Driver & Passenger #16892..... \$149.95/pr.
- 1956-57 4-Door Hardtop, Driver ... #18302..... \$82.95/ea.
- 1956-57 4-Door Hardtop, Passenger #18303..... \$82.95/ea.
- 1957 4-Door Sedan & Wagon, Driver #2968..... \$75.95/ea.
- 1957 4-Door Sedan & Wagon, Passenger #2969..... \$75.95/ea.

SEE SHIPPING INFORMATION ON PAGES 723-727 FOR EXPLANATIONS ON TRUCK FREIGHT AND OVERSIZED SHIPPING.

DOOR ADJUSTMENTS

Check clearance around all doors. Clearance at top and sides should be 1/16" to 3/16". Clearance at bottom should be 1/8" to 1/4". If the door fit is not within these limits, proceed as follows:

WHEN MAKING ADJUSTMENTS, ALWAYS:

- Scribe and remove striker plates and shims to permit door to hang free.
- Support the door when adjusting hinges.
- Make adjustments at one or both hinges as indicated by the door fit.
- Reseal all hinges and hinge plates as recommended
- After fitting doors, install and adjust striker plates.

For more information on door alignment and adjustments turn to page 663 to order part #13292 - Body and Convertible Top Adjustments Guide, for more detailed instructions.

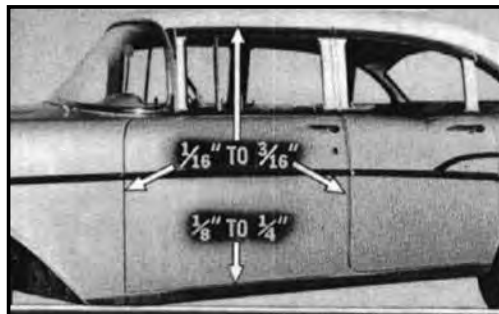

DOOR JAMB AND WINDOW SKIN PATCH PANELS

This patch panel includes the outer bit of the the rear quarter door jamb, the rear quarter window skin, the belt area and a little bit of the front quarter upper.

1955-57 2-Door Sedan, Driver.....	#18270.....	\$469.95/ea.
1955-57 2-Door Sedan, Passenger.....	#18271.....	\$469.95/ea.

#16075



DOOR HINGES

1955-57 Upper or Lower Driver	#16075.....	\$84.95/ea.
1955-57 Upper or Lower Passenger	
.....	#16076.....	\$84.95/ea.



REAR DOOR JAMB BRACES

1955-57 2-Door Hardtop, Driver ..	#17038.....	\$149.95/ea.
1955-57 2-Door Hardtop, Passenger	
.....	#17039.....	\$149.95/ea.



WIRE HARNESS DOOR SILL COVERS

1955-57 2-Door	#10133.....	\$38.95/pr.
1955-57 2-Door Sedan, Rear	#17607.....	\$43.95/pr.
1955-57 4-Door Sedan & Wagon, 4-Piece	
.....	#17605.....	\$94.95/set
1956-57 4-Door Hardtop, 4-Piece	#17606.....	\$94.95/set



DOOR JAMB REINFORCEMENTS

These fit in behind the B-pillar at the front of the rear quarter panel. Measures 26 1/2-inch x 4-inch x 6-inch. Can be used on 2-door sedans with minor modifications. **Made in the USA.**

1955-57 2-Door Hardtops & Conv., Driver	#10199.....	\$151.95/ea.
1955-57 2-Door Hardtops & Conv., Passenger	#10200.....	\$151.95/ea.



COMPLETE SHEET METAL ASSEMBLY

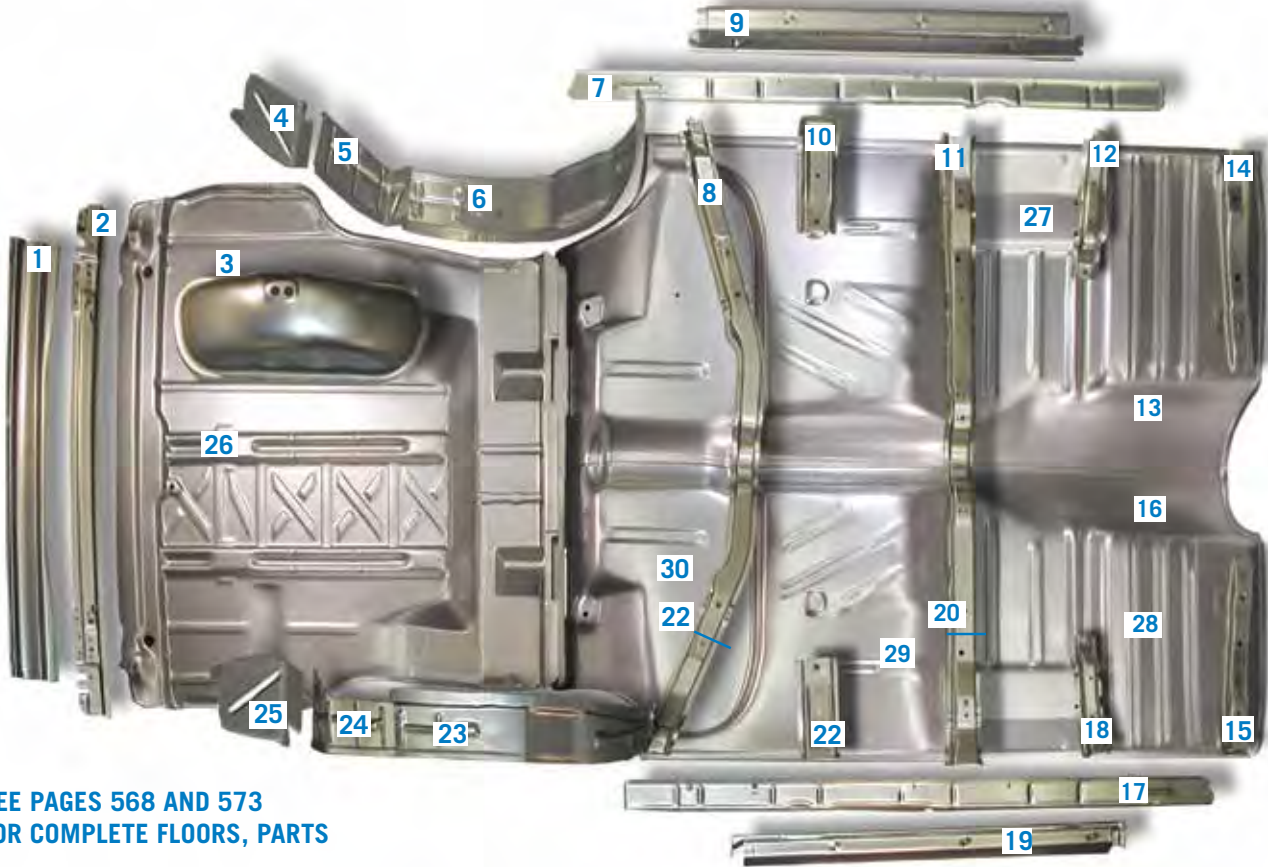

SEE PAGES 568 AND 573
FOR COMPLETE FLOORS, PARTS

DESCRIPTION	PART#	PAGE#
1. Trunk Splash Panels.....	318, 318C	581
2. Trunk Splash Panel Brace	318A, 12131.....	581, 594
3. Spare Tire Well	317	596
4. Rear Wheel Well Extensions, Passenger	2949, 2951,10191	598
5. Rear, Rear Wheel Well, Passenger	2943, 1709, 1713	597, 598
6. Front, Rear Wheel Well, Passenger.....	2945, 2947, 1706,1710	597, 598
7. Inner Rocker Panel Brace, Passenger.....	1152	557
8. Long Center Floor Brace.....	1392	575
9. Original Style Rocker Panel, Passenger.....	1832, 1834,10125	557
10. Hardtop/Convertible Short Rear Floor Brace, Passenger	1385	574
11. Long Front Floor Brace	1381, 1382.....	575
12. Short Floor Brace.....	1383	574
13. Full Half Floor Pan, Passenger	1720	570
14. Front Floor at Cowl Brace, Passenger.....	1380	574
15. Front Floor at Cowl Brace, Driver	1379	574
16. Full Half Floor Pan, Driver	1719	570
17. Inner Rocker Panel Brace, Driver.....	1151.....	557
18. Short Floor Brace.....	1383	574
19. Original Style Rocker Panel, Driver.....	1831, 1833, 10124	557
20. End Section of Long Front Floor Brace, Passenger	2921	574
Driver	2920	574
21. Hardtop/Convertible Rear Floor Brace, Driver	1384	574
22. End Sections of Long Center Floor Brace, Passenger	2312	574
Driver	2311	574
23. Front, Rear Wheel Well, Driver.....	2944, 2946, 1706, 1711.....	597, 598
24. Rear, Rear Wheel Well, Driver.....	2942, 1708, 1712.....	597, 598
25. Rear Wheel Well Extensions, Driver	2948, 2950, 10190	598
26. Full Trunk Floor	10490	571
27. Under Seat Front Floor Pan, Passenger.....	2923	576
28. Front Floor Pan, Driver	237A.....	577
29. Rear Floor Pan, Driver	238A.....	577
30. Under Seat Rear Floor Pan, Driver.....	2926	576

Passenger side

Front

Driver side

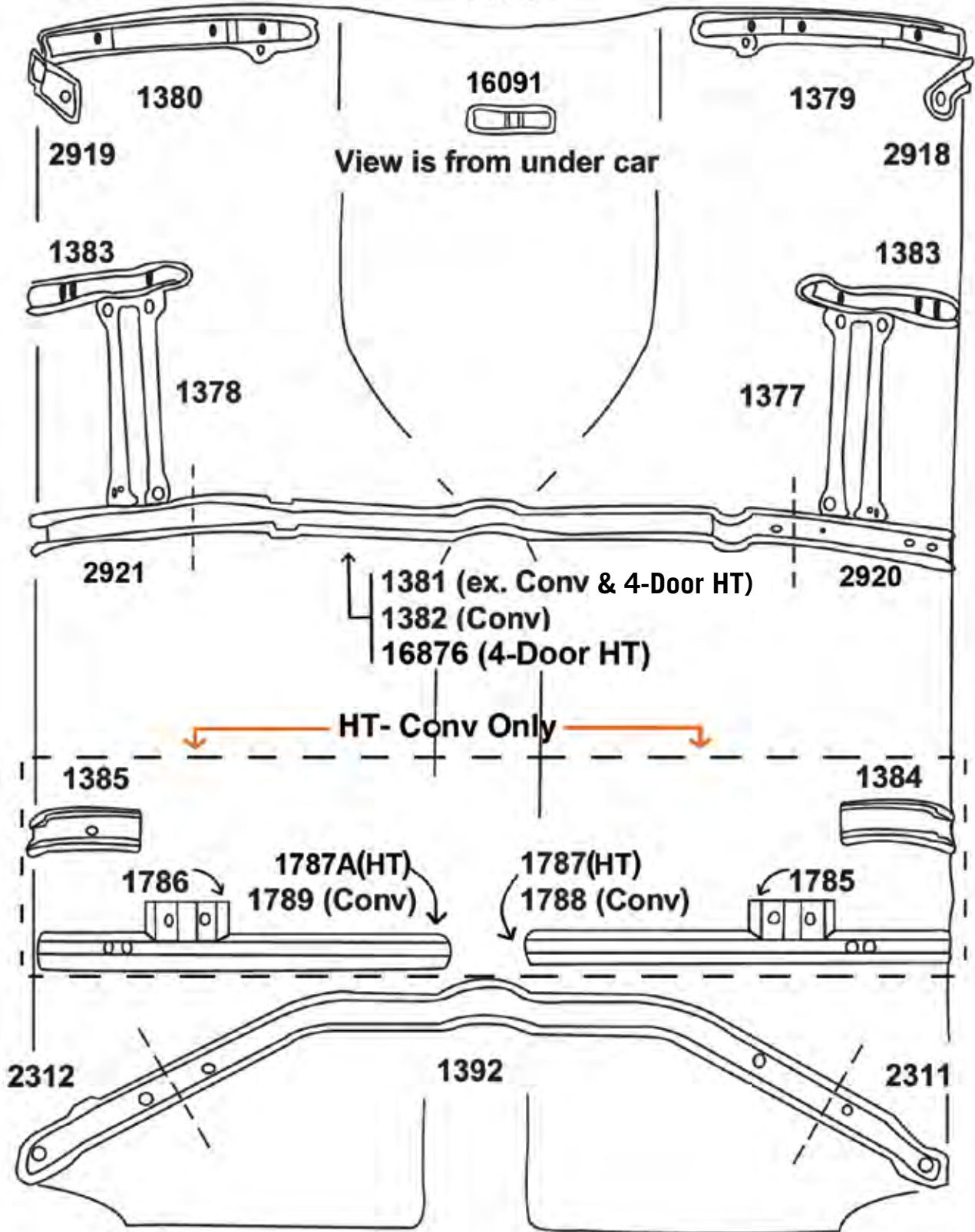



Revised 7-15-14

Floor Braces



#16092

CONVERTIBLE FLOORS WITH BRACES 

1955-57 Fully Welded	 #16092.....	\$994.95/ea.
1955-57 Fully Welded	 #12138A.....	\$1699.95/ea.

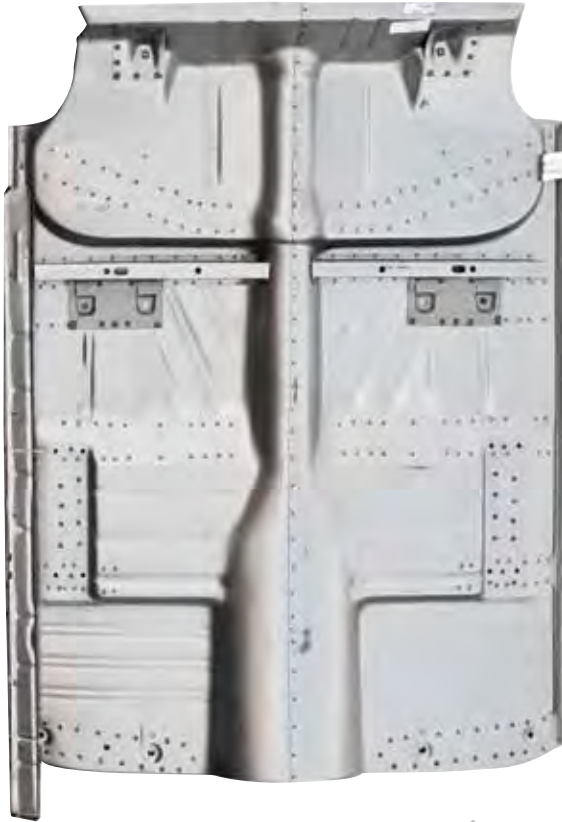

COMPLETE FLOOR FOR 2-DOOR HARDTOPS  
1955-57 Fully Welded w/ Braces.. #12138B. \$1699.95/ea.

COMPLETE FLOOR FOR SEDANS AND WAGONS  
1955-57 Fully Welded w/ Braces.. #12138... \$1699.95/ea.



COMPLETE FULLY WELDED FLOORS FOR HARDTOPS  
1955-57 w/ Braces, 2-Door..... #16113..... \$995.95/ea.
1956-57 w/ Braces, 4-Door..... #17306... \$1099.95/ea.

COMPLETE FLOOR FOR SEDANS AND WAGONS  
1955-57 Fully Welded w/ Braces.. #16119..... \$995.00/ea.



#16121



#16122



#1719

FULL LENGTH FLOOR PANS 🚗

1955-57 Hardtop & Convertible, Driver.....	🚗 #1719.....	\$238.95/ea.
1955-57 Hardtop & Convertible, Driver.....	🚗 #16097.....	\$249.95/ea.
1955-57 Hardtop & Convertible, Passenger	🚗 #1720.....	\$238.95/ea.
1955-57 Hardtop & Convertible, Passenger	🚗 #16098.....	\$249.95/ea.
1955-57 Sedan & Wagon, Driver.....	🚗 #14251.....	\$248.95/ea.
1955-57 Sedan & Wagon, Driver.....	🚗 #16121.....	\$249.95/ea.
1955-57 Sedan & Wagon, Passenger	🚗 #14252.....	\$248.95/ea.
1955-57 Sedan & Wagon, Passenger	🚗 #16122.....	\$249.95/ea.

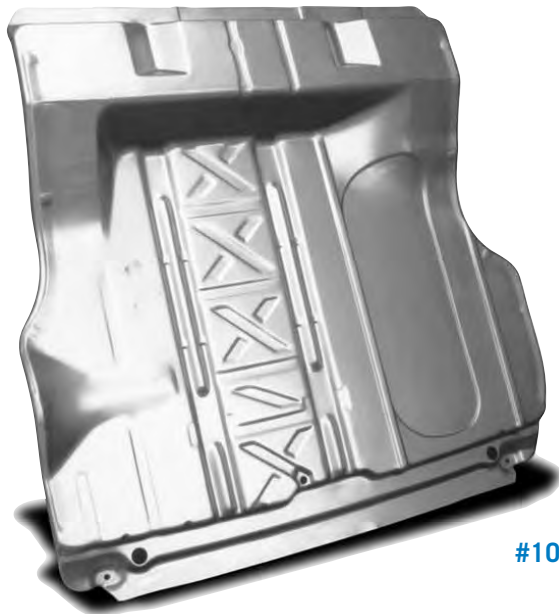

#10490



#16188



#16189



#16190



#16191

FULL TRUNK FLOORS 🚗

High quality original gauge full trunk floors. Does not include wheel well or braces.

- 1955-57 #10490 🚗 \$398.95/ea.
- 1955-57 #16191 🚗 \$419.95/ea.

COMPLETE FULL TRUNK FLOORS 🚗

These complete trunk floors come fully welded including the braces and spare tire well. Includes the gas tank straps.

- 1955-57 **Hardtop, Sedan & Convertible** #12139 🚗 \$899.95ea.
- 1955-57 **Hardtop & Sedan** #16188 🚗 \$729.95/ea.
- 1955-57 **Hardtop & Sedan, Wheel Well Delete** #16189 🚗 \$729.95/ea.
- 1955-57 **Convertible**..... #16190 🚗 \$729.95/ea.



NARROWED TRUNK FLOOR WITH BRACES WITH WIDER WHEEL TUBS KIT 🚗🚙💰

This kit includes the factory style mini-tubs #17018 saving you even more money. Trunk floor has already been modified and flanged to accept mini-tubs saving you again time and money. Spare tire well is deleted. Fits non-wagon body styles including convertible. Allows use of 13-inch wide tires when used with leaf spring pocket kit.

1955-57 #17278..... \$1079.95/kit

NARROWED TRUNK FLOOR WITH BRACES FOR WIDER WHEEL TUBS 🚗🚙💰

For use with factory style mini-tubs #17018. Trunk floor has already been modified and flanged to accept mini-tubs. Spare tire well is deleted. Fits all body styles except wagons. Allows use of 13-inch wide tires when used with leaf spring pocket kit.

1955-57 Floor Only..... #17277..... \$749.95/ea.

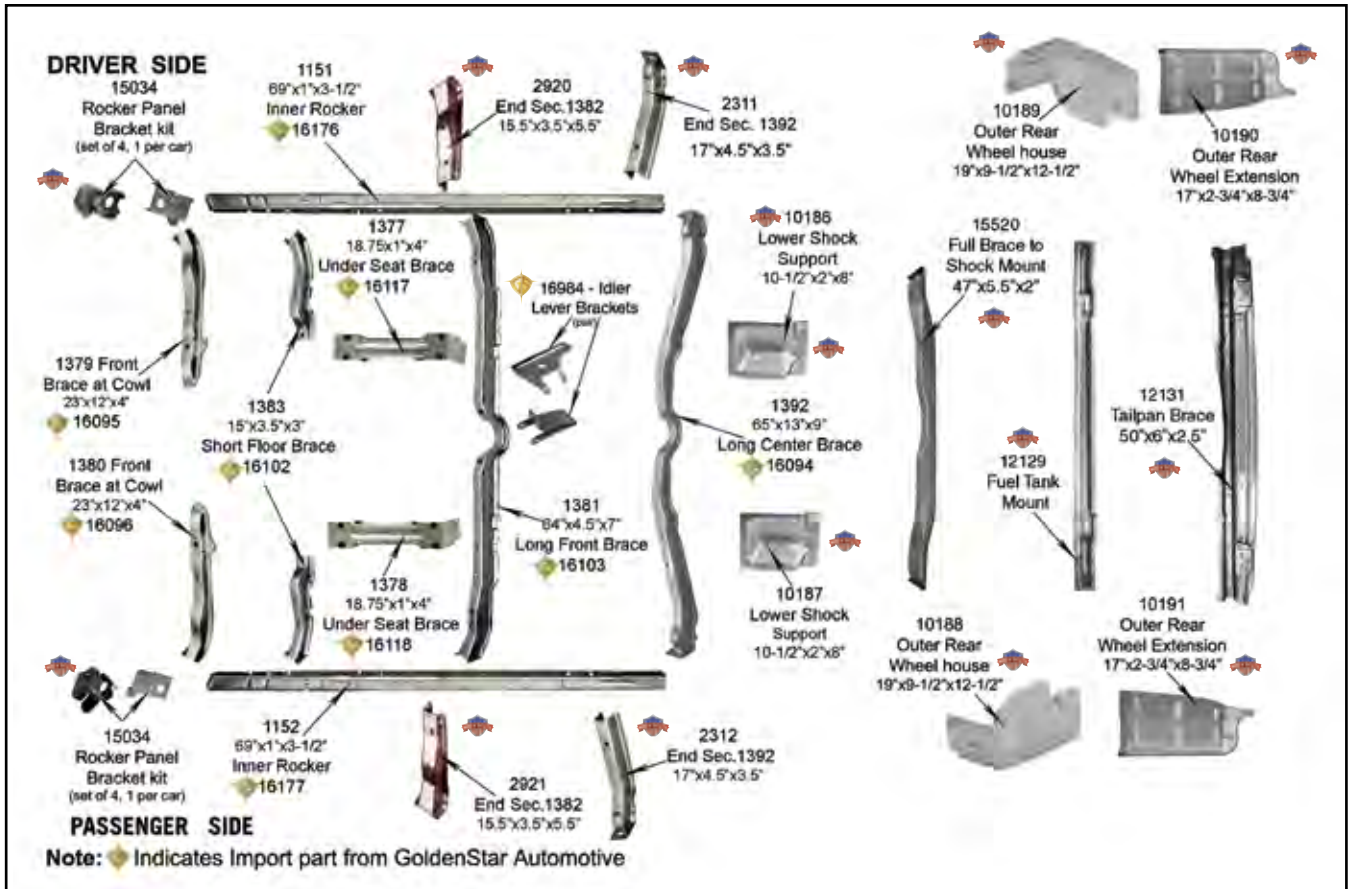



OUTER CENTER FLOOR BRACES

These are the end sections of part #1392, shown on next page. **Made in the USA.**

1955-57 Driver.....	#2311.....	\$74.95/ea.
1955-57 Passenger.....	#2312.....	\$74.95/ea.



#2920-2921



OUTER LONG FRONT FLOOR BRACES

These are the end sections of parts #1381 and #1382 shown on next page. **Made in the USA.**

1955-57 Driver.....	#2920.....	\$74.95/ea.
1955-57 Passenger.....	#2921.....	\$74.95/ea.

FLOOR TO COWL BRACES



This complete lower inner foot braces the inner dash kick panel area down to the front corners of the front floor pans. **Made in the USA.**



1955 All, '56-'57 Conv., Driver.....	#2918.....	\$104.95/ea.
1955 All, '56-'57 Conv., Passenger.....	#2919.....	\$104.95/ea.



#1384 & #1385

#16099

#16100

SHORT REAR FLOOR BRACES FOR HARDTOPS AND CONVERTIBLES

1955-57 Driver.....	#1384.....	\$36.95/ea.
1955-57 Passenger.....	#1385.....	\$36.95/ea.
1955-57 Driver.....	#16099.....	\$29.95/ea.
1955-57 Passenger.....	#16100.....	\$29.95/ea.



#1383

#16102

SHORT FRONT FLOOR BRACES

Either side, two required.

1955-57.....	#1383.....	\$34.95/ea.
1955-57.....	#16102.....	\$35.95/ea.



#1379 & #1380

#16096

#16095

SEAT RISER TO B-PILLAR SUPPORT BRACES



This is the support brace that reinforces the connection between the B-pillar support brace and the seat riser.

1955-57 Driver.....	#16481.....	\$18.95/ea.
1955-57 Passenger.....	#16482.....	\$18.95/ea.

FRONT FLOOR AT COWL BRACES

1955-57 Driver.....	#1379.....	\$62.95/ea.
1955-57 Passenger.....	#1380.....	\$62.95/ea.
1955-57 Driver.....	#16095.....	\$59.95/ea.
1955-57 Passenger.....	#16096.....	\$59.95/ea.

SEE SHIPPING INFORMATION ON PAGES 723-727 FOR EXPLANATIONS ON TRUCK FREIGHT AND OVERSIZED SHIPPING.



FULL FLOOR BRACE **O/S**

Mounts at rear shock mounts 47-inch x 5¹/₂-inch x 2-inch. **Made in the USA.**

1955-57 Wagon, Rear #15520..... \$184.95/ea.

#16116



#16103



#1381



LONG FRONT FLOOR BRACES **O/S**

1955-57 exc. Convertible and 4-Door Hardtop #1381..... \$168.95/ea.

1955-57 exc. Convertible and 4-Door Hardtop #16116..... \$159.95/ea.

1955-57 Convertible..... #1382..... \$198.95/ea.

1955-57 Convertible..... #16103..... \$194.95/ea.

MAIN FLOOR CENTER BRACE **O/S**

This is the main center brace that mounts at the center door pillar which is often rust damaged.

1956-57 4-Door Hardtop..... #16876..... \$299.95/ea.



#1392

#16094



LONG CENTER FLOOR BRACES **O/S**

1955-57 #1392..... \$148.95/ea.

1955-57 #16094..... \$159.95/ea.



#16117

#16118



#1378

#1377

FLOOR UNDER SEAT BRACES

1955-57 Driver..... #1377..... \$38.95/ea.

1955-57 Passenger #1378..... \$38.95/ea.

1955-57 Driver..... #16117..... \$39.95/ea.

1955-57 Passenger #16118..... \$39.95/ea.



UNDER SEAT FRONT FLOOR PANS O/S

Dimensions are 31-inch x 18-inch x 4-inch.

1955-57 Driver.....	#2922.....	\$68.95/ea.
1955-57 Passenger	#2923.....	\$68.95/ea.



TRANSMISSION CENTER PANEL

Dimensions are 20-inch x 36-inch. **Made in the USA.**

1955-57	#185.....	\$108.95/ea.
---------------	-----------	--------------



UNDER SEAT REAR FLOOR PANS O/S

Dimensions are 28¹/₂-inch x 23¹/₂-inch x 3-inch.

1955-57 Driver	#2926.....	\$84.95/ea.
1955-57 Passenger	#2927.....	\$84.95/ea.



#16114



#16115

#1788-1789



REAR FLOOR SEAT SUPPORTS

The rear floor seat supports are located just behind the rear floor pans. Dimensions of part #1787 and #1787A are 25⁵/₈-inch x 3³/₈-inch x 3-inch. Dimensions of parts #1788 and #1789 are 24-inch x 3³/₈-inch x 3-inch.

1955-57 exc. Convertible, Driver..	#1787.....	\$64.95/ea.
1955-57 exc. Convertible, Passenger	

.....	#1787A.....	\$64.95/ea.
1955-57 Convertible, Driver.....	#1788.....	\$68.95/ea.
1955-57 Convertible, Passenger ..	#1789.....	\$68.95/ea.
1955-57 Hardtop, Driver	#16114.....	\$66.95/ea.
1955-57 Hardtop, Passenger	#16115.....	\$66.95/ea.
1955-57 Convertible, Driver.....	#16105.....	\$69.95/ea.
1955-57 Convertible, Passenger ..	#16106.....	\$69.95/ea.



#1785

REAR FLOOR REINFORCEMENTS #16108







After replacing the rear floor sections, these panels are welded into position for added strength at the body-to-frame mount position. Adding these structural parts is an important step in the floor replacement operation. Dimensions are 10³/₈-inch x 18-inch x 7⁷/₈-inch.

1955-57 Driver.....	#1785.....	\$58.95/ea.
1955-57 Passenger	#1786.....	\$58.95/ea.
1955-57 Hardtop & Conv., Driver .	#16107.....	\$52.95/ea.
1955-57 Hardtop & Conv., Psngr..	#16108.....	\$52.95/ea.



FRONT FLOOR PANS 





Sold separately or in pairs. These fit all models, although some may require minor modification. Dimensions are 24-inch x 19-inch.

1955-57 Driver & Passenger.....	#237.....		\$116.95/pr.
1955-57 Driver.....	#237A.....		\$68.95/ea.
1955-57 Passenger.....	#237B.....		\$68.95/ea.
1955-57 Driver & Passenger.....	#17999.....		\$99.95/pr.
1955-57 Driver.....	#17999A.....		\$54.95/ea.
1955-57 Passenger.....	#17999B.....		\$54.95/ea.



REAR FLOOR PANS 

These rear pans are easily welded in. Some may require minor modification. Dimensions are 28-inch x 22-inch.

1955-57 exc. Convertible, Driver & Passenger.....	#238.....		\$153.95/pr.
1955-57 exc. Convertible, Driver.....	#238A.....		\$88.95/ea.
1955-57 exc. Convertible, Passenger.....	#238B.....		\$88.95/ea.
1955-57 exc. Convertible, Driver.....	#19417.....		\$59.95/ea.
1955-57 exc. Convertible, Passenger.....	#19418.....		\$59.95/ea.

CONVERTIBLE REAR FLOOR PANS  

Made in the USA.

1955-57 Driver (Shown).....	#2924.....	\$108.95/ea.
1955-57 Passenger.....	#2925.....	\$108.95/ea.

FLOOR PAN PLUG

For those replacing their floor pans or just replacing those old rubber parts, this plug is a necessity. Molded in tough rubber to last for years. Four per car.



1955-57.....	#813.....	\$3.50/ea.
--------------	-----------	------------



TOE BOARD PANELS  

These one-piece toe board panels include the center hump area and are designed to weld easily in place. Installs between the bottom of the firewall and the floor pans.

1955-56 1-Piece	#18639	\$239.95/ea.
1957 1-Piece	#18640	\$239.95/ea.

TOE BOARDS



TOE BOARD FLOOR PANS  

Dimensions are 25-inch x 16 1/2-inch x 1 1/2-inch.

1955-57 Driver	#2952	\$78.95/ea.
1955-57 Passenger	#2953	\$78.95/ea.









#1790 & 1791

#16109



BODY MOUNT REINFORCEMENTS

Similar to the rear floor reinforcement, the body mount reinforcements are located at the rear of the body and are the structural points for mounting the body to the frame.

1955-57 Convertible, Driver	#1790	 \$48.95/ea.
1955-57 Convertible, Passenger ..	#1791	 \$48.95/ea.
1955-57 exc. Conv., Driver	#15665	 \$49.95/ea.
1955-57 exc. Conv., Passenger	#15666	 \$49.95/ea.
1955-57 exc. Conv., Driver	#16109	 \$47.95/ea.
1955-57 exc. Conv., Passenger	#16110	 \$47.95/ea.



1957 DIMMER SWITCH MOUNT PLATE 

1957	#12133	\$38.95/ea.
-------------------	---------------------	--------------------



KICK PANEL RETAINER 

These are welded to the toe boards next to the kick panel area and hold the lower edge of the kick panel in place. For both driver and passenger sides. Measures 11-inch x 1-inch x 1-inch. **Made in the USA.**

1955-57 On Floor	#2954	\$19.95/ea.
-------------------------------	--------------------	--------------------

REAR BODY MOUNT ACCESS PLUGS

These install in the floor pan in the body mount access holes to keep out dirt and moisture.

1955-57	#812	\$9.95/pr.
----------------------	-------------------	-------------------





UPPER TRUNK FLOOR SHOCK SUPPORTS



Installing these shock supports will return the strength to your trunk floor so that it can bear the load it was designed to. Dimensions are 13-inch x 11-inch. See part #950 in the Steering and Suspension section for steel frame shock supports. Fits hardtops and sedans. **Made in the USA.**

1955-57 Driver #1441..... \$84.95/ea.

1955-57 Passenger #1442..... \$84.95/ea.



LOWER TRUNK/CARGO FLOOR SHOCK SUPPORTS

Parts #2761 and #2762 should be used in conjunction with parts #1441 and #1442. Parts #1441 and #1442 are what you see when you are looking inside the trunk, while parts #2761 and #2762 are seen when looking up from the underside of the car. Parts #10186 and #10187 fit Nomads, wagons and sedan delivery models.

1955-57 exc. Nomad & Wagon, Driver #2761..... \$68.95/ea.

1955-57 exc. Nomad & Wagon, Passenger #2762..... \$68.95/ea.

1955-57 Nomad & Wagon, Driver. #10186..... \$78.95/ea.

1955-57 Nomad & Wagon, Psngr. #10187..... \$78.95/ea.

1955-57 Nomad & Wagon, Driver. #17296..... \$58.95/ea.

1955-57 Nomad & Wagon Psngr. #17297..... \$58.95/ea.



CONVERTIBLE REAR WINDOW TO TRUNK FILLER PANEL BRACE

Supports the rear window to trunk panel. Dimensions are 28-inch x 6-inch x 7¹/₄-inch with a curve on one end.

1955-57 Driver..... #1714..... \$98.95/ea.

1955-57 Passenger..... #1715..... \$98.95/ea.



TRUNK FLOOR REAR SECTION



This is the rear portion of the trunk, approximately 10-inch x 54-inch in size. Fits all models except wagons. **Made in the USA.**

1955-57 #318B..... \$98.95/ea.



TRUNK FLOOR CENTER SECTION



This high-quality stamping is identical to the original in dimension and contour. Drops into the trunk in place of the corroded or rusted original. Dimensions are 34-inch x 35-inch. Fits all models except wagons. **Made in the USA.**

1955-57 #1234..... \$124.95/ea.



TRUNK FLOOR SECTIONS SIDE 10-INCH



Dimensions are 44-inch x 12-inch x 7-inch.

1955-57 Driver #2770..... \$84.95/ea.

1955-57 Passenger #2771..... \$84.95/ea.



TRUNK FLOOR PLATE



Two required per car.

1955-57 #2940..... \$31.95/ea.

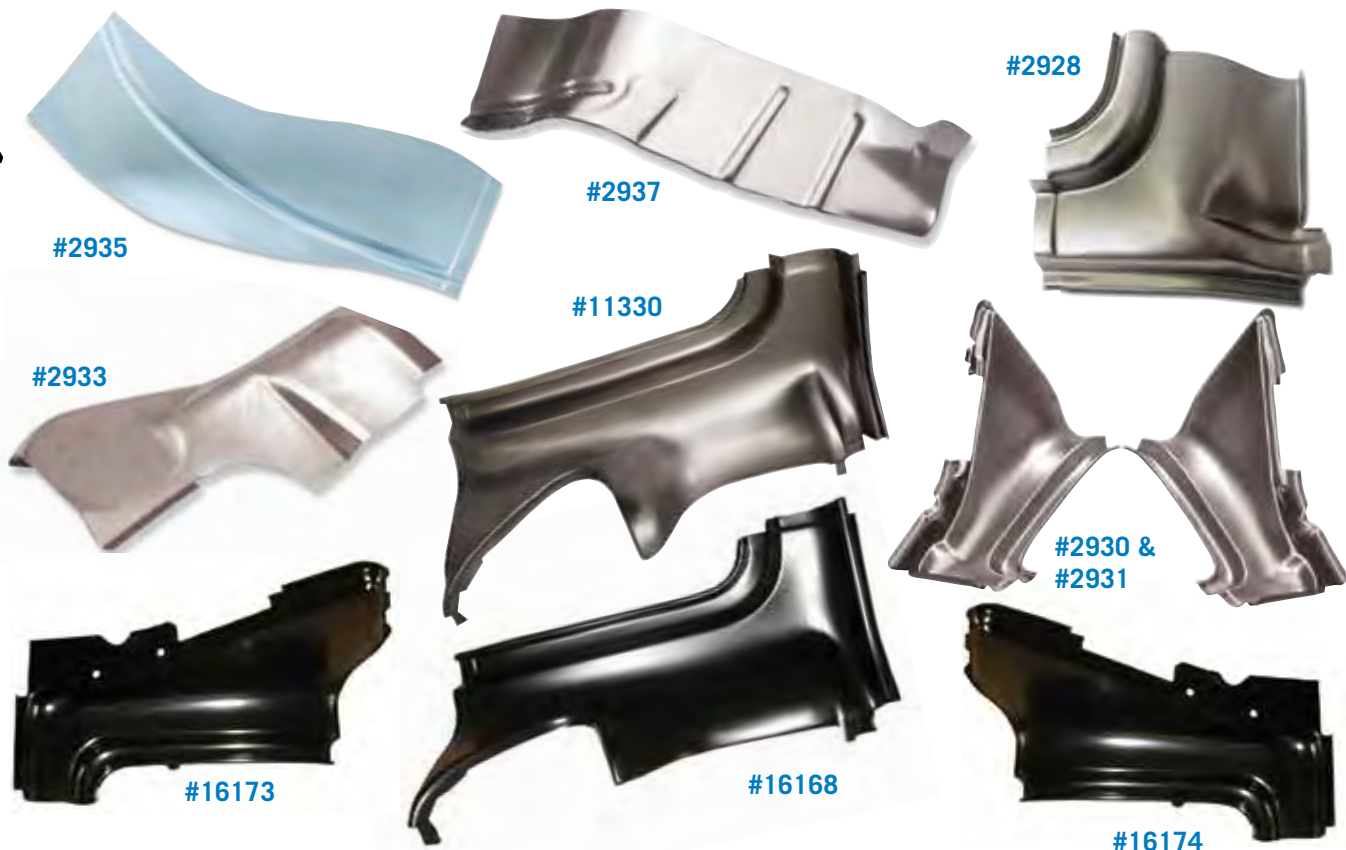

FULL OUTER TRUNK TO QUARTER PANEL PATCH PANELS

Fits all models except Nomad, wagon and sedan delivery. Partial panels shown on page 581.

1955 Driver.....	#11330.....	\$189.95/ea.
1955 Passenger.....	#11331.....	\$189.95/ea.
1955 Driver.....	#16168.....	\$184.95/ea.
1955 Passenger.....	#16169.....	\$184.95/ea.
1957 Driver.....	#2930.....	\$174.95/ea.
1957 Driver.....	#16173.....	\$174.95/ea.
1957 Passenger.....	#2931.....	\$174.95/ea.
1957 Passenger.....	#16174.....	\$174.95/ea.
1957 Driver & Passenger.....	#16175.....	\$299.95/pr.

INNER TRUNK PATCH PANELS

1955-57 Inner Trunk Wall Corner Behind Taillight Area, Driver.....	#2932.....	\$38.95/ea.
1955-57 Inner Trunk Wall Corner Behind Taillight Area, Passenger.....	#2933.....	\$38.95/ea.
1955-57 Inner Wheelhouse Lower Rear Corner Section, Driver, Hardtop & Conv ...	#2934.....	\$48.95/ea.
1955-57 Inner Wheelhouse Lower Rear Corner Section, Psngr., Hardtop & Conv...	#2935.....	\$48.95/ea.
1955-57 Inner Trunk Wall Front Lower Half, Driver, Convertible.....	#2936.....	\$58.95/ea.
1955-57 Inner Trunk Wall Front Lower Half, Passenger, Convertible.....	#2937.....	\$58.95/ea.



REAR FLOOR CENTER REINFORCEMENTS

Attaches to the underside of the rear floor in front of the shock mounts. Measures 40-inch x 1½-inch x 2½-inch.

1955-57.....	#2941.....	\$48.95/ea.
1955-57.....	#16112.....	\$52.95/ea.

#318



TRUNK SPLASH PANELS O/S

Trunk splash panel dimensions for the hardtop and sedan are 45³/₄-inch x 5¹/₂-inch; Nomad and wagon dimensions are 46³/₈-inch x 7¹/₂-inch. **Made in the USA.**

1955-57 Hardtop, Sedan & Convertible	#318.....	\$88.95/ea.
1955-57 Nomad, Wagon & Sedan Delivery	#318C.....	\$114.95/ea.

Trunk splash panel dimensions for the hardtop and sedan are 45³/₄-inch x 5¹/₂-inch.

1955-57 Hardtop, Sedan & Convertible	#16186.....	\$74.95/ea.
--	-------------	-------------



TRUNK SPLASH PANEL BRACES O/S

318A

This rear body support is the structure behind the trunk splash panels (#318 above). **Made in the USA*.**

1955-57 exc. Wagon	#318A.....	\$114.95/ea.
--------------------------	------------	--------------

This rear body support is the structure behind the trunk splash panels.

1955-57 exc. Wagon	#16187.....	\$129.95/ea.
--------------------------	-------------	--------------



NOMAD & WAGON REAR SPLASH PANEL O/S

The rear splash panel sits behind the bumper under the tailgate and between the lower rear quarter panels in the rear. Dimensions are 45³/₄-inch x 7¹/₂-inch. Will not work on sedan delivery. Oversized shipping required.

1955-57	#18902.....	\$109.95/ea.
---------------	-------------	--------------



TAILPAN TO QUARTER PATCH PANELS

The are the bottom sections of the tailpan to quarter panel. Below the taillights in the corners. Fits all models except Nomad and wagon. **Made in the USA.**

1955 Driver	#2928.....	\$89.95/ea.
1955 Passenger	#2929.....	\$89.95/ea.
1956 Driver	#10019.....	\$168.95/ea.
1956 Passenger	#10020.....	\$168.95/ea.
1957 Driver	#1704.....	\$128.95/ea.
1957 Passenger	#1705.....	\$128.95/ea.

TAILPAN TO QUARTER PATCH PANELS

The are the bottom sections of the tailpan to quarter panel. Below the taillights in the corners. Fits all models except Nomad and wagon.

1955 Driver	#18970.....	\$99.95/ea.
1955 Passenger	#18971.....	\$99.95/ea.
1956 Driver	#16170.....	\$99.95/ea.
1956 Passenger	#16171.....	\$99.95/ea.



#14152

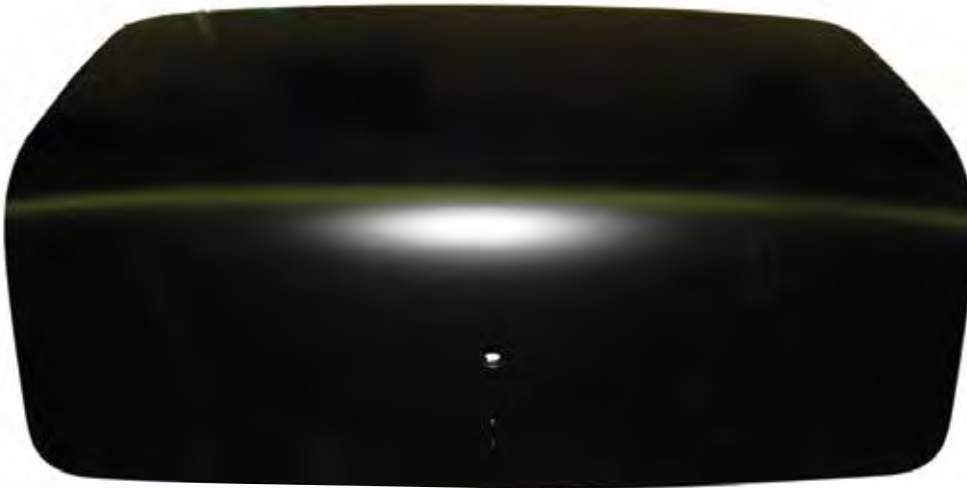





#16196



#16197

COMPLETE TRUNK LID ASSEMBLIES 

Parts #14206 and #14152 fit all passenger models and their components are die formed on electro-galvanized steel and phosphate treated, so they're ready to paint right out of the box.

1955-56	#14206 	\$849.95/ea.
1955-56 w/o Holes.....	#16196 	\$589.95/ea.
1957.....	#14152 	\$849.95/ea.
1957 w/o Holes.....	#16197 	\$589.95/ea.



OUTER TRUNK LID SKIN  

Welds to the existing trunk lid framework. Inner framework is not available. See complete trunk lid assemblies at left. **Made in the USA.**

1955-56 w/ Holes.....	#2769.....	\$398.95/ea.
1957 w/ Holes.....	#2980.....	\$398.95/ea.
1955-57 Replacement, w/o Holes.....	#2768.....	\$378.95/ea.



TRUNK INNER LID PANEL  

This is the lower end of the trunk lid inner above the rear splash pan. Dimensions are 52-inch x 2³/₄-inch x 6-inch.

1955-57	#2573.....	\$148.95/ea.
---------------	------------	--------------

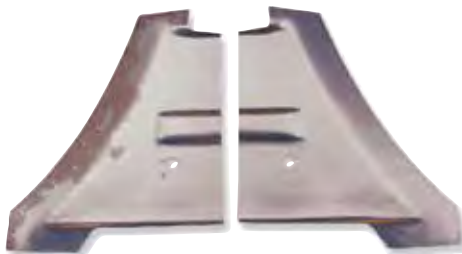

CONVERTIBLE LOWER TRUNK LID HINGE SUPPORT BRACES

This welds in between the inner wheel tub and the inner trunk wall. Dimensions are 8-inch x 2-inch x 7-inch.

1955-57 Driver.....	#1700.....	\$68.95/ea.
1955-57 Passenger	#1701.....	\$68.95/ea.



LOWER TRUNK LATCH MOUNT BRACKETS

1955-57	 #12132.....	\$49.95/ea.
1955-57	 #16195.....	\$32.95/ea.



**REAR END
SNUBBER BRACKET** 

Rubber bumper included, this bracket welds to the underside of the floor right above the differential.

1955-57	#16101 ...	\$28.95/ea.
---------------	------------	-------------

QUARTER PANELS

Stamped in heavy gauge steel with a fit and finish restorers can be proud of. The panels labeled with the "GS" logo are a factory style panel that includes the door jamb and continues to the trunk area which means less parts to buy. The American flag labeled panels are more of a skin/large patch panel. Due to the size of these parts, **all must be shipped by truck freight.**

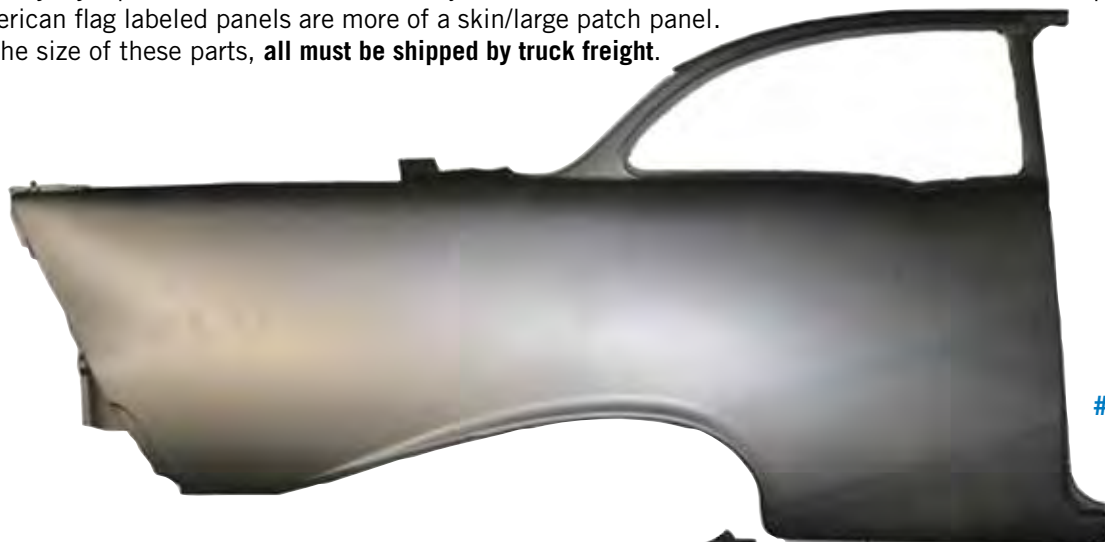

#16159



#19414





#19413



#16153

QUARTER PANELS 🚗

1955 2-Door Hardtop & Convertible, Driver, w/ Holes	#2575.....	\$748.95/ea.
1955 2-Door Hardtop & Convertible, Passenger, w/ Holes.....	#2576.....	\$748.95/ea.
1955 2-Door Hardtop & Convertible, Driver, w/o Holes.....	#2981.....	\$748.95/ea.
1955 2-Door Hardtop & Convertible, Passenger, w/o Holes.....	#2982.....	\$748.95/ea.
1955 Nomad, Driver.....	#11335.....	\$869.95/ea.
1955 Nomad, Passenger.....	#11336.....	\$869.95/ea.
1956 2-Door Hardtop & Convertible, Driver, w/o Holes.....	#2983.....	\$799.95/ea.
1956 2-Door Hardtop & Convertible, Passenger, w/o Holes.....	#2984.....	\$799.95/ea.
1956 2-Door Hardtop & Convertible, Driver, w/ Holes	#2579.....	\$768.95/ea.
1956 2-Door Hardtop & Convertible, Passenger, w/ Holes.....	#2580.....	\$768.95/ea.
1957 2-Door Hardtop & Convertible, Driver	#2577.....	\$728.95/ea.
1957 2-Door Hardtop & Convertible, Passenger	#2578.....	\$728.95/ea.
1957 2-Door Hardtop & Convertible, Driver, w/o Holes.....	#2985.....	\$728.95/ea.
1957 2-Door Hardtop & Convertible, Passenger, w/o Holes.....	#2986.....	\$728.95/ea.
1957 2-Door Hardtop, Driver, w/ Holes.....	#16154*	\$799.95/ea.
1957 2-Door Hardtop, Passenger, w/ Holes	#16155*	\$799.95/ea.
1957 Convertible, Driver, w/ Holes	#16156*	\$849.95/ea.
1957 Convertible, Passenger, w/ Holes.....	#16157*	\$849.95/ea.
1955 2-Door Sedan, Driver, w/ Window Frame.....	#16152*	\$849.95/ea.
1955 2-Door Sedan, Passenger, w/ Window Frame	#16153*	\$849.95/ea.
1956 2-Door Hardtop, Driver, No Holes	#19413. 	\$849.95/ea.
1956 2-Door Hardtop, Passenger, No Holes	#19414. 	\$849.95/ea.
1957 2-Door Sedan, Driver, w/ Window Frame, w/ SEAM.....	#16158**/**	\$899.95/ea.
1957 2-Door Sedan, Passenger, w/ Window Frame, w/ SEAM	#16159**/**	\$899.95/ea.
1955 2-Door Hardtop, Driver w/o Trim Holes	#16956*	\$799.95/ea.
1955 2-Door Hardtop, Passenger w/o Trim Holes.....	#16957*	\$799.95/ea.
1955 Convertible, Driver w/o Trim Holes	#16958*	\$799.95/ea.
1955 Convertible, Passenger w/o Trim Holes	#16959*	\$799.95/ea.

* Note: These are a full factory style quarter panel from factory weld to factory weld which includes the door jamb, outer part of the trunk channel and they wrap around the rear taillight area. ** Note: Please note these numbers have a finished seam.



#2990

REAR FULL QUARTER SECTIONS 

Measures 65-inch x 28-inch.

1957 4-Door Sedan, Driver	#2989.....	\$201.95/ea.
1957 4-Door Sedan, Passenger	#2990.....	\$201.95/ea.

#2989



CONVERTIBLE UPPER QUARTER PANELS 

These panels can be modified to use with sedan and hardtop.

1955 Driver (Shown).....	#15212.....	\$268.95/ea.
1955 Passenger	#15213.....	\$268.95/ea.

#16165
OUTSIDE



#16165
INSIDE

COMPLETE INNER QUARTER PANELS 🚗💎

These gorgeous parts cover from the rear of the door all the way back to the trunk opening. These parts include the complete inner wheelhouse, complete outer wheelhouse and extension plus the outer wheel well to quarter support.

1955-57 Sedan, Driver	#16162.....	\$695.95/ea.
1955-57 Sedan, Passenger.....	#16163.....	\$695.95/ea.
1955-57 Hardtop, Driver.....	#16164.....	\$760.95/ea.
1955-57 Hardtop, Passenger	#16165.....	\$760.95/ea.
1955-57 Convertible, Driver.....	#16166.....	\$760.95/ea.
1955-57 Convertible, Passenger	#16167.....	\$760.95/ea.



LOWER SECTION QUARTER PANELS 🚗💎

Dimensions are 88-inch x 3-1/2-inch x 20-inch.

1955 Factory Type, Driver	#2987.....	\$478.95/ea.
1955 Factory Type, Passenger (Shown)	#2988.....	\$478.95/ea.



QUARTER PANEL FIN BLOCK OFF PLATE 🚗💎

The quarter panel fin block off plate fills in the end of the quarter panel that is behind the fin moulding on the passenger side. The driver side is the fuel filler box.

1957 Passenger	#18952.....	\$29.95/ea.
----------------------	-------------	-------------



CONVERTIBLE INNER QUARTER PANELS  **O/S**

These are exact duplicates of the original rear inner quarter panels. Made of high-quality heavy gauge steel. Parts #2637 and 2638 are the sections next to the rear seat area to cover the rear wheel housing (with a cutout for the window access cover). Parts #1717 and #1718 are the sections that start over the rear wheel housing and run to the end of the inner trunk area. Use with rear inner wheel housings #2759 and #2760 shown on page 599 and you will have restored the entire inner rear quarter of your convertible. **Made in the USA.**

1955-57 Front, Driver	#2637.....	\$304.95/ea.
1955-57 Front, Passenger.....	#2638.....	\$304.95/ea.
1955-57 Rear, Driver.....	#1717.....	\$268.95/ea.
1955-57 Passenger, Rear	#1718.....	\$268.95/ea.



FACTORY STYLE QUARTER PANELS  

These 4-door hardtop full quarters have not been available until now, and they are just like they came from the factory...they cover from lead line to lead line to lead line. Will work on 1957 Chevy 4-door hardtops.

1957 4-Door Hardtop, Driver w/ Holes	#17016.....	\$499.95/ea.
1957 4-Door Hardtop, Passenger w/ Holes	#17017.....	\$499.95/ea.



SHOW QUALITY LOWER FRONT QUARTER PANELS **O/S**

These patch panels are made from new tooling assuring clean accurate lines. Measures 20-inch x 40-inch. **Made in the USA.**



1955 2-Door, Driver	#17692.....	\$164.95/ea.
1955 2-Door, Passenger	#17693.....	\$164.95/ea.



REAR QUARTER, LOWER FRONT PATCH PANELS  O/S

Dimensions are as follows: the 1955 and the 1956 are 45-inch x 19-inch, and the 1957 is 38-inch x 18-inch. Show quality pieces require less work to install and feature cleaner detail. **Made in the USA.**

1955 2-Door exc. Nomad, Driver Side, Driver Quality	#1373.....	\$95.95/ea.
1955 2-Door exc. Nomad, Passenger Side, Driver Quality	#1374.....	\$95.95/ea.
1955 2-Door, Show Quality, Driver	#17692.....	\$164.95/ea.
1955 2-Door, Show Quality, Passenger	#17693.....	\$164.95/ea.
1956 2-Door, Show Quality, Driver	#1375.....	\$164.95/ea.
1956 2-Door, Show Quality, Passenger	#1376.....	\$164.95/ea.
1957 2-Door, Driver Side, Driver Quality	#1390.....	\$113.95/ea.
1957 2-Door, Passenger Side, Driver Quality	#1391.....	\$113.95/ea.
1957 2-Door, Show Quality, Driver	#1390A.....	\$164.95/ea.
1957 2-Door, Show Quality, Passenger	#1391A.....	\$164.95/ea.



REAR QUARTER PANEL DOOR JAMB PATCH PANELS 

This is door jamb fits the 4-door hardtops only and covers from the striker plate mount down to the rocker panel. This patch panel repairs the quarter panel/door jamb area.

1956-57 Driver.....	#16985.....	\$119.95/ea.
1956-57 Passenger	#16986.....	\$119.95/ea.



GASSER BODY WHEEL WELL OPENING PATCH PANEL KIT

1955.....	#17989.....	\$164.95/kit
-----------	-------------	--------------

SEE SHIPPING INFORMATION ON PAGES 723-727 FOR EXPLANATIONS ON TRUCK FREIGHT AND OVERSIZED SHIPPING.



#1369



#1370

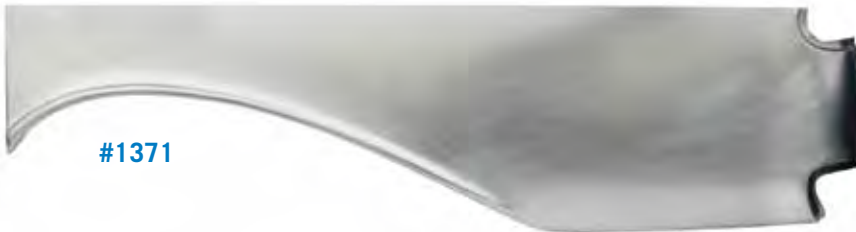

#1371



#1388



#1389

REAR QUARTER, LOWER REAR PATCH PANELS - DRIVER QUALITY  **O/S**

Dimensions are as follows: the 1955 is 45-inch x 19-inch, the 1956 is 61-inch x 19-inch, and the 1957 is 59-inch x 16-inch. **Made in the USA.**

1955 exc. Nomad, Driver	#1369	\$89.95/ea.
1955 exc. Nomad, Passenger	#1370	\$89.95/ea.
1956 Driver	#1371	..	\$109.95/ea.
1957 Driver	#1388	..	\$109.95/ea.
1957 Passenger	#1389	..	\$109.95/ea.



1957 QUARTER PANEL SUPPORT BRACES

These go in behind the rear tire and bolt to the body of the car to keep the quarter from shaking. Sold as a pair, one driver and one passenger side.

1957 Nomad, Wagon & Sedan Delivery	#19437	...	\$33.95/pr.
--	--------	-----	-------------



1955 QUARTER PANEL AND REAR BUMPER REINFORCEMENTS

Welds to inside of quarter panel where the bumper end bracket bolt goes.

Made in the USA.

1955.....	#11333...	\$41.95/pr.
-----------	-----------	-------------



1955 TAILPAN TO QUARTER FILLER PANELS

Welds to the bottom of the quarter panel.

Made in the USA.

1955.....	#11327...	\$48.95/pr.
-----------	-----------	-------------



#15030



#17689

1956 FENDER, REAR QUARTER TO REAR BUMPER BRACES 

These small braces attach to the lower rear quarter panel and to the rear quarter bumper brackets. They keep the long fender panels in place. This is a very important part to have on your car and it is missing a lot of the time. Every 56 Chevy needs a set, all models. **Made in the USA.**

1956 Best	#15030...	\$49.95/pr.
-----------------	-----------	-------------

1956 Good, w/Screws	#17689...	\$29.95/pr.
---------------------	-----------	-------------

.....	#17689...	\$29.95/pr.
-------	-----------	-------------

ROOF

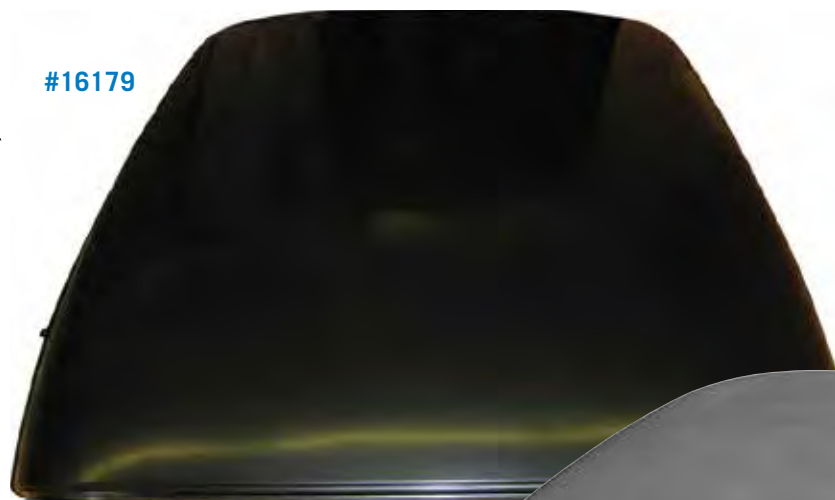

#16179

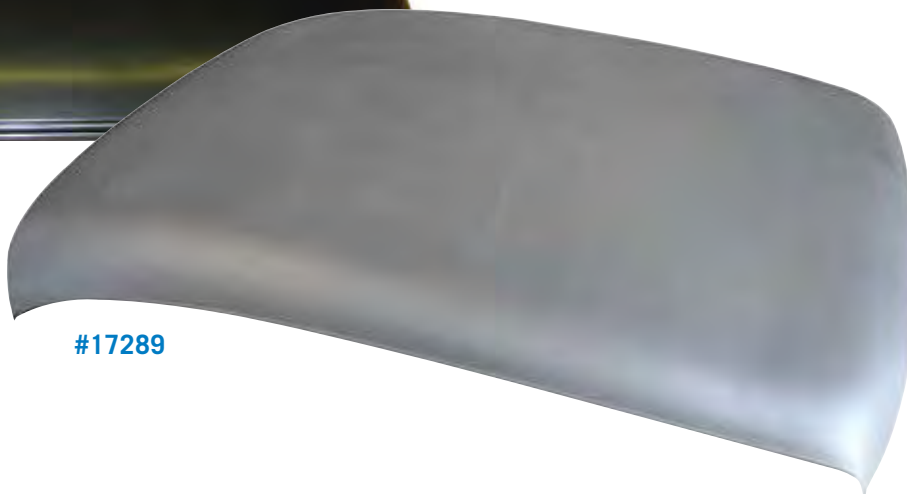

#17289

ROOF PANELS  

These large panels cover from the top of the windshield all the way back to the top of the back glass. Drip rails not included. Available separately.

1955-57 2-Door Hardtop Only	#16179.....	\$599.95/ea.
1955-57 Sedan	#17289.....	\$569.95/ea.

ROOF PANEL FRAME WITH BRACES  

1955-57 2-Door Hardtop Only	#16961.....	\$679.95/ea.
-----------------------------------	-------------	--------------



SEDAN ROOF BRACES  

1955-57 5-Piece.....	#17897.....	\$399.95/kit
----------------------	-------------	--------------



HARDTOP ROOF BRACES 

This is a complete 3-piece brace set. It comes with the center dome light bracket, the inner and outer braces front and rear all welded in and ready to go.

1955-57	#16180.....	\$449.95/set
---------------	-------------	--------------



ROOF RAILS O/S

These roof rail replacement panels are the structural panel that is just under the side of the roof panel at the door opening and quarter window opening. It runs from the windshield post to where the quarter window meets the top of the rear quarter.

1955-57 2-Door Hardtop Only #18903..... \$379.95/pr.

#16084



#16083



DRIP RAILS O/S

Also referred to as rain gutters, these pieces are necessary when replacing your roof panel.

1955-57 Hardtop, Driver	#16083.....	\$74.95/ea.
1955-57 Hardtop, Passenger	#16084.....	\$74.95/ea.
1955-57 Sedan, Driver	#17388.....	\$83.95/ea.
1955-57 Sedan, Passenger.....	#17389.....	\$83.95/ea.



#16061



#16062 TOP VIEW



#1716

REAR WINDOW TO TRUNK PANELS O/S

Part #1716 measures 51³/₄-inch x 1¹/₄-inch x 12-inch.
Part #12228 measures 52-inch x 1¹/₂-inch x 14¹/₄-inch.

1955-57 Convertible.....	#1716.....	\$128.95/ea.
1955-57 2-Door Hardtop.....	#12228.....	\$184.95/ea.
1955-57 Convertible.....	#16061.....	\$109.95/ea.

CONVERTIBLE REAR WINDOW TO TRUNK FILLER PANEL BRACE O/S

Only available as two sections before now, make life a little easier with this one-piece rear window brace assembly.

1955-57 #16062..... \$259.95/ea.



PACKAGE TRAYS

TRUNK AND PACKAGE SHELF PANELS  

These comprehensive parts include the trunk to window panel along with the package tray which runs from the window to the seat back. Comes with the brace attached.

1955-57 2-Door Hardtop Only with Brace.....	#16060.....	\$259.95/ea.
1955-57 Sedan with Brace	#16063.....	\$259.95/ea.
1955-57 Sedan with Brace and Rear Window Gasket Channel	#17434.....	\$299.95/ea.



REAR WINDOW GASKET CHANNEL  

The bottom of your rear window seal sits here and is definitely required if you replace the rear deck pillar.

1955-57 Bottom	#16064.....	\$59.95/ea.
----------------------	-------------	-------------



Thanks for sending your photo!

STEVEN MEDLER FROM ENGLAND



NOMAD TAILGATE ASSEMBLY O/S

1955-57 #17960..... \$979.95/ea.



WAGON TAILGATE ASSEMBLY O/S

1955-57 #17279..... \$699.95/ea.



#14649

#17779



TAILGATE SKINS O/S

Just like a door skin this installs over the existing tailgate inner framework.

1955-57 Nomad	#14941	\$348.95/ea.
1955-57 Nomad	#17779	\$299.95/ea.
1955-57 Wagon	#14649	\$248.95/ea.
1955-57 Wagon	#17280	\$165.95/ea.



TAILPAN BRACE  

Attaches to the underside of the splash panel to provide rear body support. Measures 50-inch x 6-inch x 2 1/2-inch. **Made in the USA.**

1955-57 Nomad & Wagon..... #12131..... \$359.95/ea.

TAILPAN

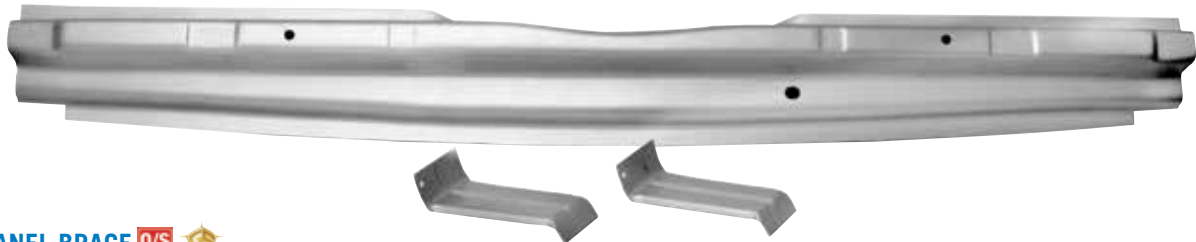

TAIL PANEL BRACE  

Often damaged in an accident this piece gets mounted directly to the tail panel giving it structural integrity

1955-57 Sedan Delivery #17696..... \$166.95/ea.



 **NOMAD AND WAGON TAILPAN SUPPORT**

These tailpan supports will add support and stability to your tailpan brace. These only fit the Nomad and wagon models. Two are required for a complete job. **Made in the USA.**

1955-57 #15599 . \$48.95/ea.



1957 WAGON TAILPAN TO QUARTER PANEL PATCH PANELS 

These patch panels cover from top of the fin pinch weld down to the tailpan and over to the tailgate opening. Comes in weld-thru primer.

1957 Driver #17697 \$279.95/ea.

1957 Passenger #17698 \$279.95/ea.

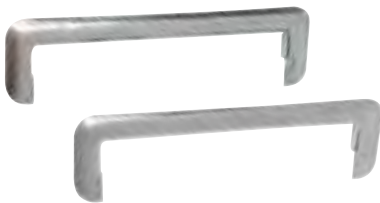

NOMAD & WAGON TAILGATE HINGE TRIM

Finishes the raw edge of the tailgate skin at the lower hinges. Snaps in as original.

1955-57 #16889... \$59.95/pr.



1955 TAILPAN TO QUARTER FILLER PANELS

Welds to the bottom of the quarter panel. **Made in the USA.**

1955..... #11327... \$48.95/pr.



CARGO FLOOR COMPLETE  
 1955-57 with Braces, w/ Extensions & Spare Tire Well
 #17207 ... \$1159.95/ea.



CARGO FLOOR WITH BRACES & EXTENSION  
 1955-57 w/o Spare Tire Well #17291 \$679.95/ea.



CARGO FLOOR  
 1955-57 Nomad, Wagon & Sedan Delivery
 #10182 \$168.95/ea.



CARGO FLOOR  
 1955-57 Nomad, Wagon & Sedan Delivery
 #17294 \$154.95/ea.

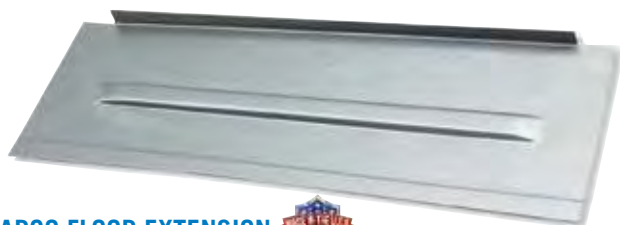

CARGO FLOOR EXTENSION  
 Two required. Made in the USA.
 1955-57 Nomad, Wagon & Sedan Delivery
 #10183 \$38.95/ea.



NOMAD & WAGON CARGO FLOOR EXTENSIONS 
 1955-57 Driver #17292 \$37.95/ea.
 1955-57 Passenger #17293 \$37.95/ea.

CARGO FLOOR TRIM SCREWS
 1955-57 Nomad & Wagon 156-Piece
 #15427 \$17.95/set

CARGO FLOOR SUPPORT BAFFLE SET 
 1955-57 Nomad & Wagon, 4-Piece
 #18417 \$189.95/set

 **WARNING!** Products on these pages may contain chemicals known to the State Of California to cause cancer and/or birth defects or reproductive harm. www.p65warnings.ca.gov



SPARE TIRE

COMPLETE SPARE TIRE WELL  
 1955-57 Nomad & Wagon..... #17205..... \$419.95/ea.

#317

#16192

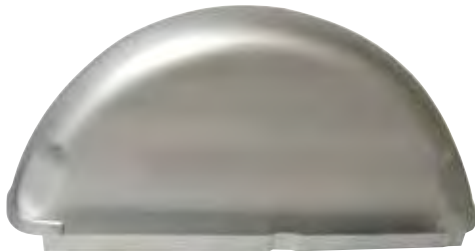

SPARE TIRE WELLS 
 Fits all models **except Nomads, wagons and sedan delivery.**
 Easily welded into place of your old tire well. Dimensions
 are 10¹/₂-inch x 29¹/₄-inch. **Made in the USA.**
 1955-57  #317..... \$104.95/ea.
 1955-57  #16192..... \$87.95/ea.

SPARE TIRE WELL UPPER PATCH  
 1955-57 Nomad & Wagon..... #17206..... \$125.95/ea.

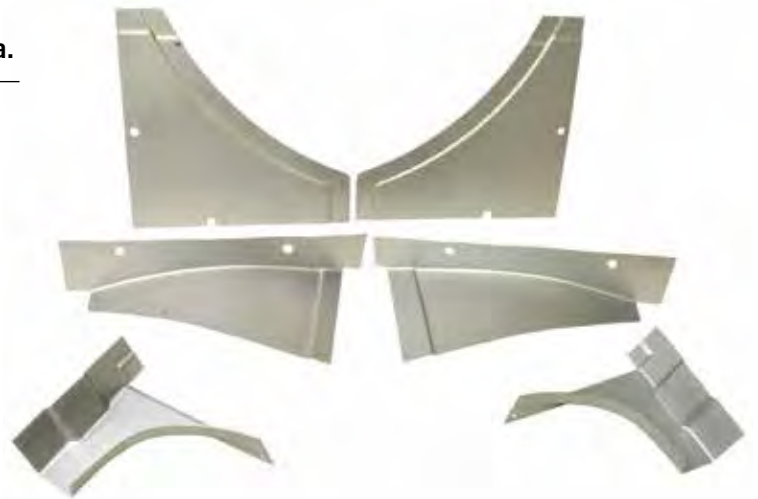

LOWER SPARE TIRE WELL  
 1955-57 Nomad, Wagon & Sedan Delivery
 #17295..... \$199.95/ea.

SPARE TIRE WELL EXTENSION KIT 
 1955-57 Nomad & Wagon..... #17290..... \$89.95/kit



#10181



LOWER SPARE TIRE WELL  
 1955-57 Nomad, Wagon & Sedan Delivery
 #10181..... \$228.95/ea.

SPARE TIRE WELL COVER 
 If you are looking to remove your spare tire well to make more
 room, we've got just the part. Welds in. **Made in the USA.**
 1955-57 #12189..... \$92.95/ea.







#1706-1707



#1713

#1712

OUTER REAR WHEEL HOUSINGS 

1955 Rocker to Mid Wheel, 2-Door Sedan, Driver	#1706		\$104.95/ea.
1955 Rocker to Mid Wheel, 2-Door Sedan, Passenger.....	#1707		\$104.95/ea.
1955 Mid to Rear Wheel, 2-Door Sedan, Driver	#1708		\$84.95/ea.
1955 Mid to Rear Wheel, 2-Door Sedan, Passenger	#1709		\$84.95/ea.
1956-57 Rocker to Mid Wheel, 2-Door Sedan, Driver	#1710		\$114.95/ea.
1956-57 Rocker to Mid Wheel, 2-Door Sedan, Passenger.....	#1711		\$114.95/ea.
1956-57 Mid to Rear Wheel, 2-Door Sedan, Driver.....	#1712		\$104.95/ea.
1956-57 Mid to Rear Wheel, 2-Door Sedan, Passenger	#1713		\$104.95/ea.



#18297



#18299

#18301



#17910

OUTER REAR WHEEL HOUSINGS WITH EXTENSIONS  

These outer wheel housings come with rocker to mid and mid to rear sections welded together and ready to install. The 1955 units come with the rear wheel extensions installed, and the 1956-57 units will require adding the appropriate extensions, which are not included, but can be found on page 598.

1955 Hardtop, Driver	#18296	\$141.95/ea.	1956-57 Hardtop, Driver	#17909	\$141.95/ea.
1955 Hardtop, Passenger.....	#18297	\$141.95/ea.	1956-57 Hardtop, Passenger	#17910	\$141.95/ea.
1955 Convertible, Driver	#18298	\$141.95/ea.	1956-57 Convertible, Driver	#18300	\$141.95/ea.
1955 Convertible, Passenger	#18299	\$141.95/ea.	1956-57 Convertible, Passenger ..	#18301	\$141.95/ea.
1955 Sedan, Driver.....	#16198	\$139.95/ea.	1956-57 Sedan, Driver	#18030	\$141.95/ea.
1955 Sedan, Passenger	#16199	\$139.95/ea.	1956-57 Sedan, Passenger.....	#18031	\$141.95/ea.

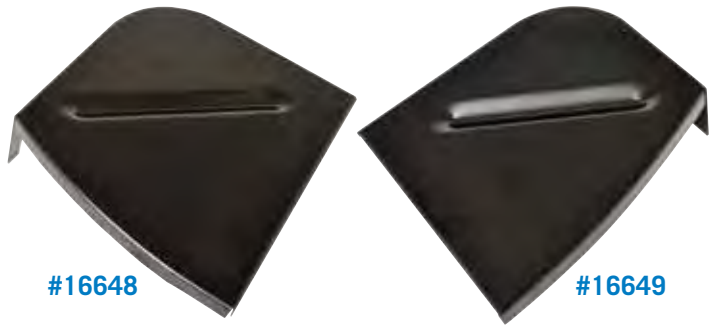

OUTER REAR WHEEL HOUSINGS 

1955-57 Rear Section, Hardtop & Convertible, Driver (Shown)	#2942.....	\$74.95/ea.
1955-57 Rear Section, Hardtop & Convertible, Passenger (Shown)	#2943.....	\$74.95/ea.
1955-57 Front Section, Hardtop, Driver	#2944.....	 \$88.95/ea.
1955-57 Front Section, Hardtop, Passenger	#2945.....	 \$88.95/ea.
1955-57 Front Section, Convertible, Driver	#2946.....	\$94.95/ea.
1955-57 Front Section, Convertible, Passenger	#2947.....	\$94.95/ea.
1956-57 Nomad, Wagon & Sedan Delivery, Driver	#10188.....	\$98.95/ea.
1956-57 Nomad, Wagon & Sedan Delivery, Passenger	#10189.....	\$98.95/ea.

REAR WHEEL HOUSING EXTENSIONS 

1955 exc. Wagon & Sedan Delivery, Driver	#2948.....	\$44.95/ea.
1955 exc. Wagon & Sed. Del., Passenger (Shown)	#2949.....	\$44.95/ea.
1955 exc. Wagon, Driver	#16648.....	\$48.95/ea.
1955 exc. Wagon, Passenger	#16649.....	\$48.95/ea.
1956-57 exc. Wagon & Sedan Delivery, Driver	#2950.....	\$46.95/ea.
1956-57 exc. Wagon & Sedan Delivery, Passenger	#2951.....	\$46.95/ea.
1956-57 Nomad, Wagon, & Sedan Delivery, Driver	#10190.....	\$64.95/ea.
1956-57 Nomad, Wagon, & Sed. Del., Psngr. (Shown)	#10191.....	\$64.95/ea.
1956-57 exc. Wagon & Sedan Delivery, Driver	#16492.....	\$46.95/ea.
1956-57 exc. Wagon & Sedan Delivery, Passenger	#16493.....	\$46.95/ea.



REAR INNER WHEEL WELLS 

Can be trimmed to fit Nomad models.

1955-57 2 & 4-Door Wagon, Driver	#15875.....	\$288.95/ea.
1955-57 2 & 4-Door Wagon, Passenger	#15876.....	\$288.95/ea.



REAR WHEEL HOUSING SEALS 

When replacing the rear quarter panel, the rear wheel housing seal, which seals the quarter panel to the inner fender well, should be replaced also. **Made in the USA.**

1955-57	#851.....	\$24.95/set
---------------	-----------	-------------

SEE SHIPPING INFORMATION ON PAGES 723-727 FOR EXPLANATIONS ON TRUCK FREIGHT AND OVERSIZED SHIPPING.

MINI TUB KIT  **O/S**

This tub kit is steel construction weld-in designed made specifically to fit the shape of stock inner wheel well. Standard size is flush with frame rails, adding 3-inches of tire width potential if leaf spring pocket kit or alternative coil over shock rear suspension is utilized. Requires minor rear seat frame modifications. **Made in the USA.**



1955-57 #12183..... \$432.95/kit

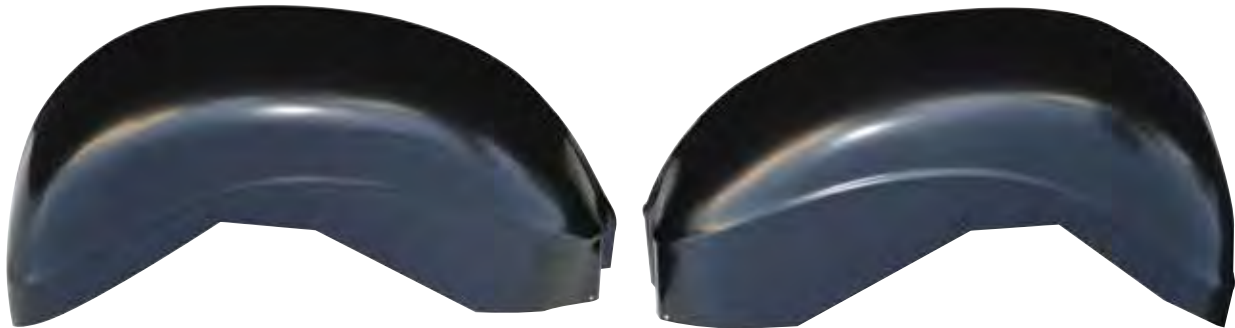

FACTORY STYLE MINI TUBS  **O/S**

These mini tubs appear to be normal wheel wells from Chevrolet but they are a full 2⁵/₈-inches wider to accommodate those larger meats. Sold as a pair. Requires floor pan modification.

1955-57 Sedan & Hardtop #17018..... \$379.95/pr.



REAR INNER WHEEL HOUSINGS  **O/S**

These inner wheel house panels are made of heavy gauge steel just like the originals. Sedans measure 42-inch x 10¹/₂-inch x 25¹/₂-inch. Hardtop measure 42¹/₂-inches x 7¹/₂-inch x 24-inch.

1955-57 2-Door Sedan, Driver #2270..... \$208.95/ea.
 1955-57 2-Door Sedan, Psngr..... #2271 \$208.95/ea.
 1955-57 2-Door Hardtop, Driver ... #253..... \$208.95/ea.
 1955-57 2-Door Hardtop Psngr #254..... \$208.95/ea.



CONVERTIBLE REAR INNER WHEEL HOUSINGS  **O/S**

These inner wheel house panels are made of heavy gauge steel just like the originals. Dimensions are 48-inch x 8¹/₂-inch x 21-inch. **Made in the USA.**

1955-57 Driver..... #2759..... \$214.95/ea.
 1955-57 Passenger..... #2760..... \$214.95/ea.



CONVERTIBLE

CONVERTIBLE WINDSHIELD FRAME  

1955-57 #19423..... \$479.95/ea.



CONVERTIBLE "X" FRAME ASSEMBLY  

1955-57 #10440 \$949.95/ea.



CONVERTIBLE DRAIN CHANNELS 

Drain channels are located behind the rear seat area, just below the rear pinchweld. **Made in the USA.**

1955-57 Driver.. #10004 \$109.95/ea.

1955-57 Psngr. . #10005 \$109.95/ea.

1955-57 Center. #10006 \$174.95/ea.



CONVERTIBLE TOP CYLINDER LOWER BRACES

1955-57  #10009... \$29.95/pr.

1955-57  #16111... \$29.95/pr.



CONVERTIBLE BACKREST SUPPORT  

Replace that worn out area behind the rear seat. Made of heavy gauge sheet metal.

1955-57 #2574 .. \$168.95/ea.



CONVERTIBLE BACKREST SUPPORT BRACKETS 

Attaches the backrest support to the rear inner wheel tubs. **Made in the USA.**

1955-57 Driver.. #10011.. \$39.95/ea.

1955-57 Psngr. . #10012.. \$39.95/ea.

CONVERTIBLE ARMREST AND PISTON COVER ASSEMBLIES  O/S

Chevy made their piston cover assemblies out of steel, not fiberglass. The adherence to Chevy's design makes these piston cover assemblies true reproductions, with a fit and finish that can only be attained in steel. This ready-to-upholster piston cover includes ashtray cutouts and are sold in pairs. Please see page 124 for ashtrays. **Made in the USA.**



1955 (Shown) ... #2204... \$379.95/pr.



CONVERTIBLE DRAIN CHANNEL REINFORCEMENTS 

These drain channels and reinforcements are designed to "channel" away the water around, down and out of your convertible top before it can do damage. Made of high quality sheet metal. **Made in the USA.**

1955-57 Driver.. #2591.... \$28.95/ea.

1955-57 Passenger
..... #2592.... \$28.95/ea.



CONVERTIBLE FRAME RAIL SKID PLATES  O/S

1955-57 Driver..... #10437 \$139.95/ea.

1955-57 Passenger #10438 \$139.95/ea.



CONVERTIBLE INNER QUARTER TO UPPER SUPPORT PANEL BRACKETS

Welded to the top inner wheel hub in the trunk just outboard of the trunk hinge.

1955-57 Driver.. #10021.. \$82.95/ea.

1955-57 Psngr. . #10022.. \$82.95/ea.



CONVERTIBLE OUTER WHEEL WELL TO QUARTER PANEL SUPPORTS 

Welds to the top of the other wheel well and supports the quarter panel.

1955-57 Driver..... #1702 \$77.95/ea.

1955-57 Passenger #1703 \$77.95/ea.



CONVERTIBLE WINDSHIELD CENTER PILLAR 

This is the top center windshield pillar/frame that is subject to the elements and sometimes gets damaged by rust.

1955-57 #16483 \$129.95/ea.

WOODY'S HOT RODZ 1955 AND 1957 LICENSED STEEL BODIES

LICENSED STEEL BODIES



PERFORMANCE
OFFICIAL LICENSED BODIES

After years of dreaming, and anticipating, they are here, licensed steel reproduction bodies, fully assembled and welded, with more high-strength spot welds than the originals. Careful attention is paid to every detail of fit and finish. Built on a stationary jig to eliminate panel shifting for superior body assembly & panel gaps. Features corrosion resistant high strength steel with a white PPG epoxy coating throughout, and is ready for final bodywork and paint.

Complete Bodies include: floor, firewall, dash, trunk floor, tail pan, rear window to trunk panel, trunk walls, wheel housings, outer quarter panels, outer quarter to trunk panels, trunk hinges, inner & outer rockers, roof structure, top skin with drip rail (not convertible), doors, hinges & latches, trunk lid, trunk torsion bars, front fenders, inner fenders, hood, splash pad & core support (6 or 8-cylinder). **Body Shells include:** floor, firewall, dash, trunk floor, tail pan, rear window to trunk panel, trunk walls, wheel housings, outer quarter panels, outer quarter to trunk panels, trunk hinges, inner & outer rockers, roof structure & top skin with drip rail (not convertible).



1955 BODY COMPLETE 

- 1955 Hardtop Body.....#17662\$21995.95/ea.
- 1955 Sedan Body.....#17663\$21995.95/ea.
- 1955 Convertible Body.....#17664\$21995.95/ea.

1955 BODY SHELL 

- 1955 Hardtop Body.....#17668\$15495.95/ea.
- 1955 Sedan Body.....#17669\$15495.95/ea.
- 1955 Convertible Body.....#17670\$15495.95/ea.

1957 BODY COMPLETE 

- 1957 Hardtop Body.....#17665\$21995.95/ea.
- 1957 Sedan Body.....#17666\$21995.95/ea.
- 1957 Convertible Body.....#17667\$21995.95/ea.

1957 BODY SHELL 

- 1957 Hardtop Body.....#17671\$15495.95/ea.
- 1957 Sedan Body.....#17672\$15495.95/ea.
- 1957 Convertible Body.....#17673\$15495.95/ea.

The Dream Begins with a Body Built by Woody's Hot Rodz.

Sheet Metal

LICENSED STEEL BODIES



WHAT IS AN MSO (MCO)?

An MSO or MCO is short for a manufacturer's statement (or certificate) of origin. We are not a vehicle manufacturer, thus we do not issue an MSO or MCO. We do, however, issue a body number and invoice (by selling dealer) that will take the place of the MCO when registering your vehicle in your state.

HOW DO I TITLE AND REGISTER A CAR BUILT USING A NEW BODY?

If you do not have a new or original chassis with a title or MSO, you will need to register the car built with a NEW body as a "Newly Assembled" vehicle with your state. While we do not issue an MSO, you will be issued a Bill Of Sale (your purchase invoice). This invoice will be considered as an MSO by your state DMV (check your local laws and regulations).

WHAT IF I HAVE AN EXISTING TITLE AND VIN?

We DO NOT suggest using the VIN plate from an original car transferred onto a NEW body. Particularly if you are a shop building the car for a customer. This practice can get you into a lot of trouble. However, if you hold clear title to an original frame to be used under your NEW body, have the state inspect the frame and verify the VIN before assembly. For 1955-57 Chevrolet passenger car frames, the VIN is stamped in two places on top of the driver's side frame rail. In most cases, your state will issue you a readable VIN plate/tag that matches your frame and title that may be displayed on the body.

- 50% DEPOSIT REQUIRED ON TOTAL AMOUNT OF ORDER DUE WITHIN 7 DAYS OF PLACING ORDER. PAYMENTS CAN BE MADE VIA MONEY ORDER, CASHIER'S CHECK, WIRE TRANSFER OR PERSONAL CHECK WILL BE ACCEPTED. HOWEVER, ORDER FOR BODY CANNOT BE PLACED UNTIL YOUR PERSONAL CHECK HAS CLEARED. A \$500 CREDIT CARD DEPOSIT MAY BE MADE VIA PHONE AT THE TIME THE ORDER IS TAKEN TO RESERVE THE BODY/CHASSIS.

- ALL BODIES AND FRAMES HAVE A MINIMUM 90 DAY LEAD TIME.

- CONVERTIBLES DO NOT COME WITH TOP BOWS.

- ALL BODIES AND FRAMES WILL BE ASSIGNED A SALES NUMBER BASED ON THE DATE OF THE SALE, SHIPMENTS WILL BE MADE FIRST IN/FIRST OUT.

- DEPOSITS ARE NON-REFUNDABLE ONCE THE ORDER FOR THE BODY OR FRAME HAS BEEN PLACED.



STAINLESS FRONT END SHEET METAL FASTENERS

Uses button head bolts, clip nuts supplied are not stainless.

- 1955..... #14038..... \$68.95/ea.
- 1956..... #14039..... \$71.95/ea.
- 1957..... #14040..... \$78.95/ea.

REAR BODY MOUNT ACCESS PLUGS

These install in the floor pan in the body mount access holes to keep out dirt and moisture.



- 1955-57 #812..... \$9.95/pr.

FLOOR PAN PLUG

For those replacing their floor pans or just replacing those old rubber parts, this plug is a necessity. Molded in tough rubber to last for years. Four per car.



- 1955-57 #813..... \$3.50/ea.

TRUNK AREA INNER ACCESS PLUGS

These install high on the trunk side walls inside the trunk. Set of 4. One set required per car.



- 1955-57 #810..... \$13.95/set

SPARE TIRE WELL PLUG

These plugs fill the holes found in the bottom of the spare tire well. Sold as each, two needed per car. You can also use these for the holes in the ends of the rocker panels.



- 1955-57 #825..... \$3.95/ea.

ROCKER PANEL PLUGS

These install in the bottom of the rocker between the B-Pillar and the rear wheel opening on 2-Door models and about the center of the rear door on 4-door models. **Made in the USA.**



- 1955-57 #826..... \$8.95/pr.

FRONT END SHEET METAL SCREW SETS

Containing over 250 pieces, this is the most complete kit available. Included are body bolts and washers, fender shims, speed nuts, cage nuts, countersunk and self-tapping sheet metal screws, rivets, and SAE washers. Most pieces are cadmium plated or painted, except for the radiator support bolts, which have a black oxide finish.



- 1955 (Shown) #791..... \$71.95/set
- 1956..... #792..... \$71.95/set
- 1957..... #793..... \$71.95/set

BODY MOUNT BOLT AND WASHER KITS

Replace your body mount hardware when you replace the body mounts. These kits are grade 5 bolts and washers, the correct amount for each model.



- 1955-57 Hardtop (Shown)..... #496..... \$15.95/kit
- 1955-57 Sedan, Nomad & Wagon #497..... \$15.95/kit
- 1955-57 Convertible..... #498..... \$15.95/kit



BODY MOUNT KITS

- 1955-57 Hardtop, Good #18849..... \$65.95/kit
- 1955-57 Sedan & Wagon, Good ... #18850..... \$59.95/kit
- 1955-57 Convertible, Good #18851..... \$42.95/kit

POLISHED ALUMINUM BODY MOUNT RETAINERS WITH BOLTS

- 1955-57 Single (Shown) #10058..... \$24.95/ea.
- 1955-57 14-sets #10059..... \$293.95/set



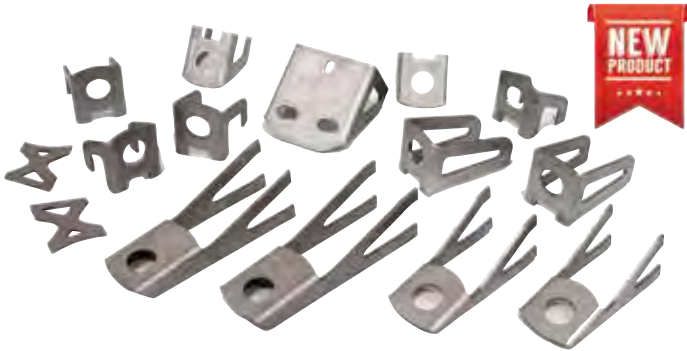

REPLACEMENT BODY MOUNT FRAME BRACKETS

1955-57 #19441 \$274.95/kit



BODY MOUNT BUSHING COVERS

1955-57 Hardtop & Convertible.... #17208..... \$325.95/set



BODY MOUNT SETS  #532

Start your frame-off restoration with our superior body mount sets. If you can't do a complete frame-off, just replace them one by one. Top-quality rubber is molded to cad plated steel. We've upgraded this set to include a set of body mount shims. **Made in the USA.**

1955-57 Hardtop..... #532..... \$99.95/set
 1955-57 Sedan, Nomad & Wagon #532A..... \$89.95/set
 1955-57 Convertible..... #532B..... \$59.95/set
 1955-57 Rear Body Mount Access Plugs
 #812..... \$9.95/pr.



SINGLE RECTANGULAR BODY MOUNTS

1955-57 #15790..... \$5.95/ea.
 1955-57 #15791 \$8.95/ea.
 1955-57 #15794..... \$10.95/ea.

SINGLE SQUARE BODY MOUNT

1955-57 #15789..... \$3.55/ea.

SINGLE ROUND, LARGE BODY MOUNTS

1955-57 #15792..... \$3.95/ea.
 1955-57 #15793..... \$5.50/ea.
 1955-57 w/ Shoulder & Washer ... #15795..... \$7.95/ea.

NOTE: See photos to view shapes and configurations of mounts.

BODY MOUNT SHIMS 



When mounting sheet metal to the body, be sure to use Danchuk body mount shims.

These shims help you to properly shim the body to the frame. They are zinc plated for corrosion resistance with tabs at each corner to prevent shifting. **Made in the USA.**

1955-57 #2094..... \$16.95/set

BODY MOUNT FRAME BRACKET

Missing a body mount bracket on your hardtop or convertible? This replacement steel frame bracket is used on the outside of the frame under the quarter window area on 2-Door hardtops and convertibles and used on the inside of the frame in the forward trunk area on all convertibles.



1955-57 Hardtop & Convertible.... #17959..... \$49.95/ea.



BLACK URETHANE BODY MOUNTS

1955-57 Hardtop..... #981..... \$91.95/set
 1955-57 Conv. #982..... \$91.95/set
 1955-57 Sedan #983..... \$91.95/set



#390



#294



#295

FENDER ANTI-SQUEAK GASKET KITS



These kits contain an assortment of specialized parts, each one die cut or extruded to exact specifications. Whether you are doing a front clip removal for an engine detail, or a complete frame-off restoration, this is the only way to totally eliminate front end body panel squeaks. **Made in the USA.**

1955.....	#294.....	\$16.95/kit
1956.....	#390.....	\$21.95/kit
1957.....	#295.....	\$18.95/kit



HOOD ANTI-SQUEAK GASKET KITS



These kits are die cut to exact specifications and are necessary to prevent the hood panels from squeaking. **Made in the USA.**

1955-56	#857.....	\$8.95/kit
1957.....	#391.....	\$10.95/kit

REAR WHEEL HOUSING SEALS



Complete the job. When replacing the rear quarter panel, the rear wheel housing seal, which seals the quarter panel to the inner fender well, should be replaced also. **Made in the USA.**



1955-57	#851.....	\$24.95/set
---------------	-----------	-------------

REAR ACCESSORY FENDER-TO-FENDER SKIRT SEALS



All accessory fender skirts should be wrapped with these seals before installation to protect the paint finish on the fenders. Sold as a pair. **Made in the USA.**



1955-57	#554.....	\$11.95/pr.
---------------	-----------	-------------

INNER FENDER SEALS



Our fender seals are manufactured with rubber formulas that far outlast the original parts. These inner fender seals are an absolute must when replacing or repairing front fenders or inner fender wells. **Made in the USA.**



1949-56	#558.....	\$20.95/pr.
1957.....	#559.....	\$20.95/pr.

FRONT SPLASH PAN SEALS



These rubber dust seals were installed at the outer edges the splash pan on both sides to help protect your engine compartment from water and dirt. The "C" edge slips up over the edge of the splash pan with the flap facing up and forward. It was originally stapled in four places on each side. It will be necessary to poke a hole in the outer edge so the outer splash pan to fender bolt may be installed. **Made in the USA.**

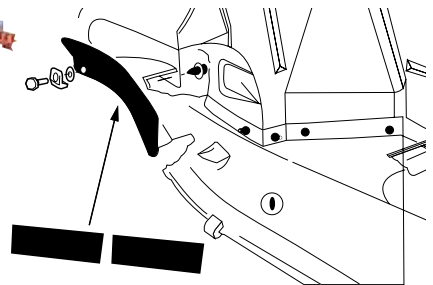

1957.....	#288.....	\$12.95/pr.
-----------	-----------	-------------

13. Doors & Windows

SECTION AT A GLANCE:

Door Handles	608
Door Locks	612
Door Latches	614
Door Lock Related	613
Door Lock Knobs	616
Door Hinge & Related	617
Flippers	618
Door Trim	620
Keyless Entry	621
Window Regulators	622
Power Window	623
Moulding Clips	625
Fur Channel	626
Windshield Moulding	628
Wiper Arms	632
Wiper Kits & Related	634
Glass Channels	635
Quarter Window & Related	638
Vent Window & Related	640
Seals	643
Nomad Trim	646
Liftgate	648
Tailgate	650
Screws & Fasteners	654
Window Glass Sets	655



EDDIE MOTORSPORTS BILLET OUTSIDE DOOR HANDLES
 1955-57 Polished, Sedan, Wagon, Nomad, 4-Door Hardtop #17171 \$315.95/pr.
 1955-57 Satin, Sedan, Wagon, Nomad, 4-Door Hardtop #17172 \$315.95/pr.



#369

#370

DOOR HANDLE GUARDS

Protect your paint with these beautifully die-cast and triple-chrome plated accessories. Reproduced to the original specifications, these guards will add brilliant detail to your car. Our #369 and #370 are the "Best" American versions, while the #V369 is a truly very good American version. Mounting screws included. **Made in the USA***.

1955-56 Best #369* \$54.95/pr.
 1955-56 Good #V369* \$54.95/pr.
 1955-56 Import #16700 \$28.95/pr.
 1957 Best #370* \$54.95/pr.
 1957 Good #16701 \$35.95/pr.



POLISHED BILLET ALUMINUM WINDOW HANDLES
 1955-57 #10454 \$119.95/pr.



POLISHED BILLET ALUMINUM INSIDE DOOR HANDLES
 1955-57 #10452 \$109.95/pr.



POLISHED BILLET ALUMINUM VENT HANDLES
 1955-57 #10453 \$114.95/pr.



OUTSIDE DOOR HANDLE GASKETS

1955-57 #81807 \$5.50/pr.



DECK HANDLE GASKET

We produce this unique gasket specifically for the sedan delivery and wagon.
 1955-57 #848 \$2.95/ea.

PAINT GASKETS

Kit includes gaskets for door handles, door and trunk lock tumblers, antenna, and outside rear view mirror. **Made in the USA.**

1955-57 2-Door #395 \$9.95/set
 1955-57 4-Door (Shown) #395A \$11.95/set



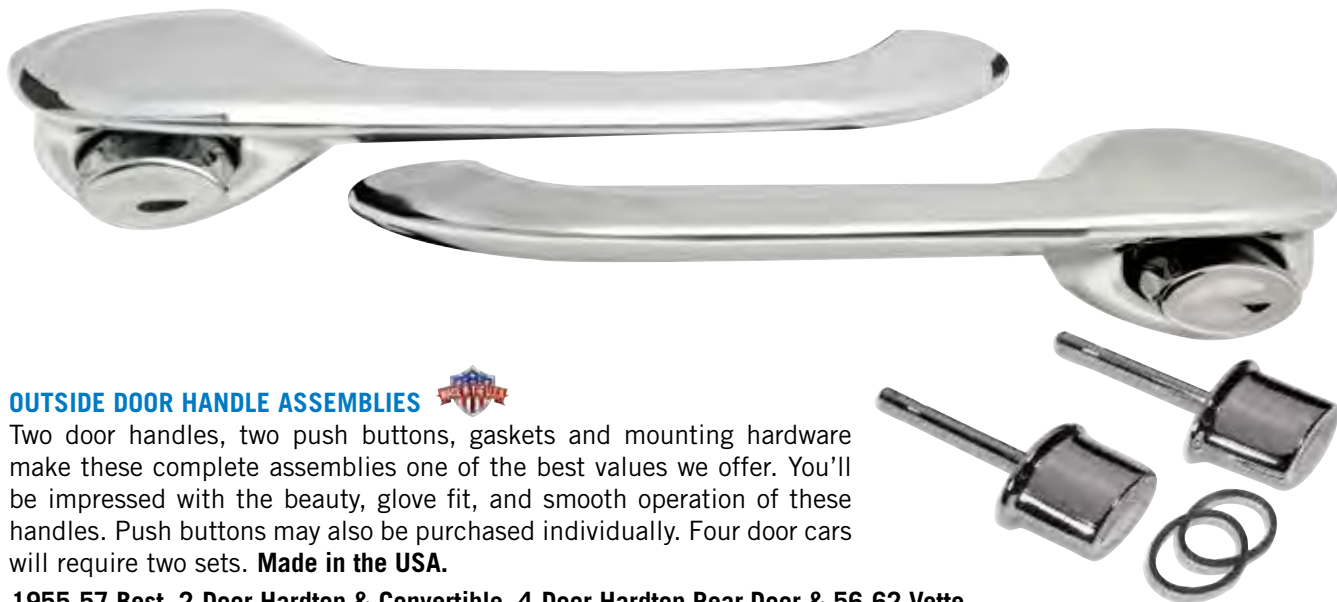

OUTSIDE DOOR HANDLE ASSEMBLIES



Two door handles, two push buttons, gaskets and mounting hardware make these complete assemblies one of the best values we offer. You'll be impressed with the beauty, glove fit, and smooth operation of these handles. Push buttons may also be purchased individually. Four door cars will require two sets. **Made in the USA.**

1955-57 Best, 2-Door Hardtop & Convertible, 4-Door Hardtop Rear Door & 56-62 Vette	#794.....	\$99.95/set
1955-57 Good, 2-Door Hardtop & Convertible, 4-Door Hardtop Rear Door & 56-62 Vette	#16716.....	\$65.95/set
1955-57 Best, Sedan, Nomad, Wagon & 4-Door Hardtop Front Door	#794A.....	\$99.95/set
1955-57 Good, Sedan, Nomad, Wagon & 4-Door Hardtop Front Door	#16750.....	\$74.95/set
1955-57 Push Buttons Only	#359.....	\$29.95/pr.

INSIDE DOOR HANDLES

This is one super quality reproduction, complete with the original groove details and brilliant plating. Includes plastic washers and mounting clips.



1955-57 Best	#367.....	\$34.95/pr.
1955-57 Good	#16741.....	\$17.95/pr.



WINDOW CRANK HANDLES

We mount a glossy, black plastic knob to a beautifully detailed and plated handle. Made with the same quality as the original handles. Plastic backing washers and mounting clips included.

1955-57 Best	#624.....	\$29.95/pr.
1955-57 Good	#16748.....	\$19.95/pr.



VENT WINDOW CRANK HANDLES

A molded, glossy black plastic knob is fastened to a beautifully plated handle, complete with plastic backing washers and mounting clips.

1955-57 Best	#623.....	\$29.95/pr.
1955-57 Good	#16747.....	\$19.95/pr.



LOKAR BILLET CRESCENT OVAL AND OVAL ARM REST DOOR PULLS

All Polished, Crescent Oval	#17269.....	\$150.95/pr.
All Polished, Oval	#17270.....	\$150.95/pr.



LOKAR ALUMINUM INSIDE DOOR HANDLES

Lokars interior handles feature splined arms for fine adjustment and hidden set screws for that extra attention to detail.

All Brushed.....	#15234.....	\$98.95/pr.
All Polished (Shown).....	#15235.....	\$98.95/pr.
All Black	#15240.....	\$98.95/pr.

LOKAR LAKESTER HANDLES

All Door, Chrome.....	#17271.....	\$98.95/pr.
All Window Cranks, Chrome	#17272.....	\$98.95/pr.
All Vent Window Cranks, Chrome..	#17273.....	\$98.95/pr.
All Door, Midnight Series.....	#18401.....	\$98.95/pr.
All Window Crank, Midnight Series	#18402.....	\$98.95/pr.
All Vent Window Crank, Midnight Series	#18403.....	\$98.95/pr.



LOKAR ALUMINUM WINDOW CRANK HANDLES

All Brushed.....	#15236.....	\$98.95/pr.
All Polished.....	#15237.....	\$98.95/pr.
All Black (Shown).....	#15241.....	\$98.95/pr.



LOKAR ALUMINUM VENT WINDOW CRANK HANDLES

All Brushed (Shown)	#15238.....	\$98.95/pr.
All Polished.....	#15239.....	\$98.95/pr.
All Black	#15242.....	\$98.95/pr.



LOKAR OUTSIDE CUSTOM BILLET DOOR HANDLES

Billet exterior 12-volt door handles are a great way to elevate your vehicle to the next level. Lokar's door handle utilizes a 12-volt pressure pad switch to supply power to the electric actuated door latch. Fabrication required.

All Brushed, Goolsby Edition, 10 Degree, 12-Volt
 #17558..... \$412.95/pr.



CHROME HANDLES WITH BLACK AND CARBON INSERTS

All Door Handles..... #18802..... \$100.95/pr.
All Window Cranks..... #18803..... \$100.95/pr.
All Vent Window Cranks #18804..... \$100.95/pr.



GRAY TRUSS-STYLE HANDLES

All Door Handles..... #18805..... \$127.95/pr.
All Window Cranks..... #18806..... \$132.95/pr.
All Vent Window Cranks #18807..... \$116.95/pr.



HANDLE CLIP REMOVAL TOOL

Removes the horseshoe shaped handle clip, part #215, holding the inside door, window, and vent window handles on all cars utilizing that clip. This tool makes handle removal a snap. Fits many makes and models.

1955-57 #637..... \$8.95/ea.

HANDLE CLIP

Interior door, window and vent window handles are all mounted with this retaining clip. You'll need one clip for each handle mounted. When removing interior handles, the handle clip removal tool, part #637, is essential. This tool is shown above right.



1955-57 #215..... \$0.95/ea.

DOOR AND WINDOW HANDLE SPRING

Use this spring to maintain a firm seal between the inside door handle and the door panel.



1955-57 #625..... \$3.50/ea.

DOOR AND WINDOW HANDLE PLASTIC WASHER

This part fits between the inside door and window handles and the interior door panel.



1955-64 #362..... \$2.25/ea.



PHOTO COURTESY OF GERTMAN2000

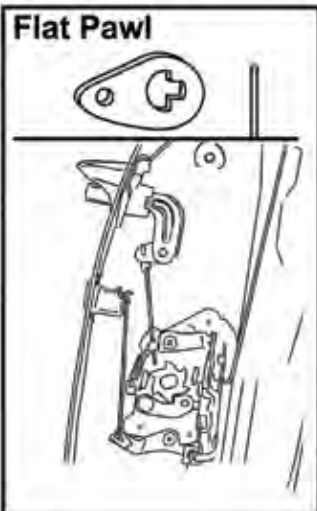

Flat Pawl

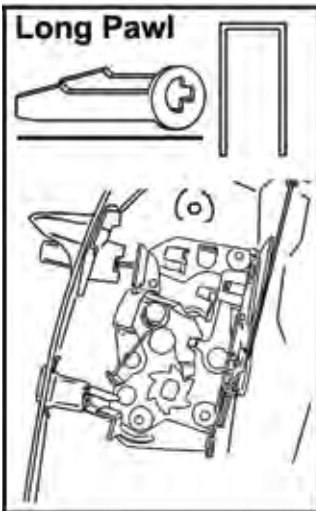

Long Pawl

FLAT PAWL APPLICATIONS

For use on 1956 2 & 4-Door Hardtops and Convertibles and 1957 4-Door Hardtops ONLY.

LONG PAWL APPLICATIONS

All 1955-57 Models except Flat Pawl applications at left.



COMPLETE LOCK SETS

1955-57 Keyed Alike, Long Pawl.. #15517 \$69.95/set
 1955-57 Keyed Alike, Flat Pawl ... #15518..... \$69.95/set



FRONT DOOR HANDLE RELEASE MECHANISMS

This excellent reproduction is made of stamped steel.
 1956-57 4-Door Hardtop, Front #16995.....\$28.95/pr.



DOOR & IGNITION LOCK SETS

Two keys, ignition lock, and two door locks make up each perfectly reproduced set. The faces of the door locks are stainless steel, and the ignition lock turn handles are die-cast and chrome plated. Check your existing lock set carefully before ordering. See pawl chart above.

1955-57 Flat Pawl (Shown)..... #385A..... \$44.95/set
 1955-57 Long Pawl #385B..... \$44.95/set



INTERIOR DOOR RELEASE MECHANISMS

This excellent reproduction is made of stamped steel.
 1955-59 Driver..... #957..... \$21.95/ea.
 1955-59 Passenger #957A..... \$21.95/ea.



DOOR LOCK CATCH MECHANISM SCREW SET

1955-57 #971 \$8.95/set



DOOR LOCK RETAINERS

You can insure that your new door locks will stay in place for good by installing them with new door lock retainers. Our door lock retainers are made of heat treated spring steel for the strongest spring pressure, and are cad plated for rust and corrosion protection. **Made in the USA.**

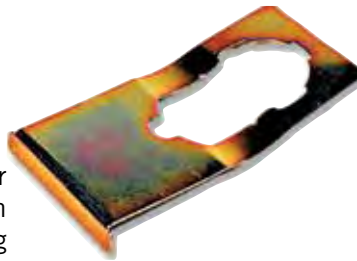

1955-57 2-Door Hardtop, Convertible, 4-Door Sedan & Wagon (Shown) #1905..... \$10.95/ea.
1955-57 2-Door Sedan, Wagon & Sedan Delivery, 4-Door Hardtop & Nomad #2035..... \$9.95/ea.



TRUNK AND GLOVE BOX LOCK SET

A trunk lock, glove box lock, and two keys make up this quality set. The face of the trunk lock is stainless steel. Trunk lock does not fit wagons.

1955-57 #386..... \$29.95/set

RIBBED LOCK CAP

This stainless steel cap, which comes on new locks, accurately finishes off the lock set with the original design contour. Use this to replace caps on original locks.



1955-58 #2107..... \$4.95/ea.

TRUNK LOCK RETAINER



Re-install the trunk lock with a new lock retainer. Each retainer is heated to provide maximum pressure and cad plated to prevent rust and corrosion. **Made in the USA.**

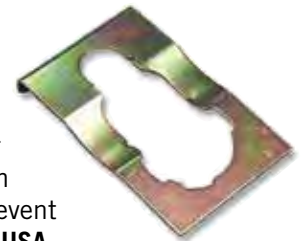

1955-57 #388..... \$11.95/ea.

#17835



LOCK CYLINDER PAWL CLIPS

This clip holds the lock pawl to the lock cylinder.

1955-57 #17835..... \$0.95/ea.
All Half-Moon Shaft..... #19029..... \$0.50/ea.



#19029

TRIDENT STYLE LOCK PAWL RETAINER CLIP

This clip holds the lock pawl to the lock cylinder.

1955-57 #19042..... \$1.95/ea.



TRUNK LOCK SHAFT

This reproduction part is easily installed and will bring back that smooth-operating trunk lock.

1955-57 #387..... \$1.95/ea.

TRUNK LOCK SHAFT RETAINER SPRING

This spring holds the trunk lock shaft into the trunk lock cylinder and often goes missing.

All..... #14946..... \$0.50/ea.



#14160

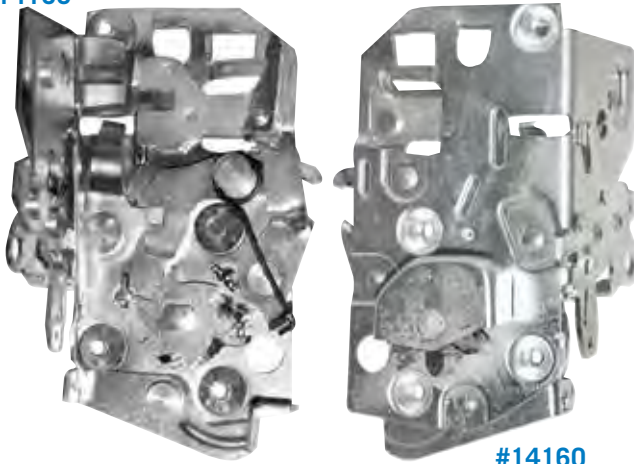

#14160

#16072



#16071

COMPLETE DOOR LATCH ASSEMBLIES

These long pawl style door latches are brand new and ready to replace your troublesome or worn out originals. Chevy used different style latches, the long pawl style was most popular so be sure to check your originals before ordering. Be sure to pick up a set of striker plates, part #1847, to insure you have all the right parts. Door latch assemblies will not work on '56 2-door hardtops and convertibles or 1956-57 4-door hardtops.

1955 Driver.....	#14160.....	\$99.95/ea.
1955 Passenger.....	#14161.....	\$99.95/ea.
1956-57 Driver.....	#14162.....	\$99.95/ea.
1956-57 Passenger.....	#14163.....	\$99.95/ea.



KEY BLANKS

These are Briggs and Stratton replacements. Keys are uncut blanks.

1955-57 Trunk & Glove Box	#097.....	\$2.95/ea.
1955-57 Ignition & Door.....	#098.....	\$2.95/ea.



DOOR LATCH TO TUMBLER RODS AND CLIPS

When you have a problem opening your door with your existing key chances are the your rods might be missing. This is the part you need to replace. **Made in the USA.**

1956 2-Door Hardtop & Convertible	#15533.....	\$16.95/set
---	-------------	-------------



REPLACEMENT KEY BLANKS

These are the correct "A" and "B" key blanks for our reproduction lock cylinders. Pearhead shaped blanks are typically used on trunk and glovebox keys and octagon shaped are typically used for doors and ignition. For original lock cylinders see part #097 and #098.

1955-57 "B" Groove, Pear Head... #17836.....	\$3.95/ea.
1955-57 "A" Groove, Octagon Head	#17837..... \$3.95/ea.



DOOR LATCH TO HANDLE PULL RODS WITH CLIPS

These run from the door latch handle to the door latch. Proper sleeves and clips included.

1955-57 2-Door Sedan, Nomad & 2-Door Wagon	#14223.....	\$25.95/pr.
1955-57 2-Door Hardtop & Convertible.....	#14308.....	\$25.95/pr.
1956-57 4-Door Hardtop, Front Door.....	#18319.....	\$25.95/pr.
1955-57 4-Door Sedan, Rear Door.....	#17955.....	\$9.95/pr.
1955-57 4-Door Sedan, Front Door	#17958.....	\$24.95/pr.

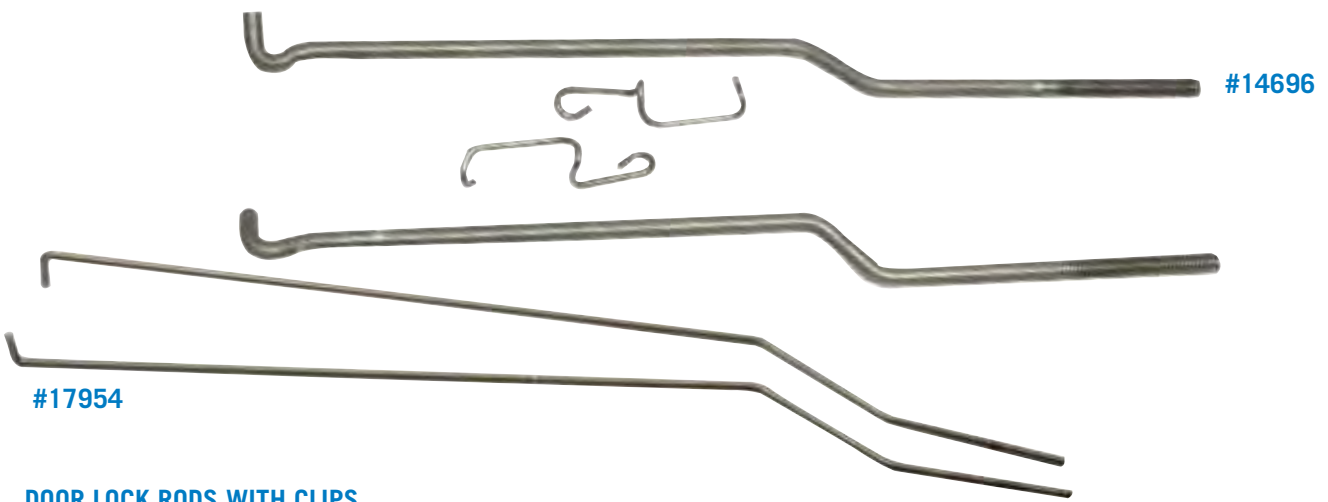

DOOR LOCK RODS WITH CLIPS

These are the rods that the door lock knob, #329, screws onto. Clips are sold separately under part #14698.

1955-57 2-Door Hardtop & Convertible.....	#14696.....	\$9.95/pr.
1955-57 Sedan, Nomad & Wagon	#14697.....	\$9.95/pr.
1955-57 Tailgate/Door, Clips Only	#14698.....	\$2.50/pr.
1956-57 4-Door Hardtop, Front Door.....	#17954.....	\$8.95/pr.



REAR DOOR LOCK ROD ASSEMBLIES

These are the rods for the rear doors that the door lock knob, #329 screws onto. Complete assembly.

1955-57 4-Door Sedan, Driver (Shown)	#17956.....	\$27.95/ea.
1955-57 4-Door Sedan, Passenger.....	#17957.....	\$27.95/ea.



BILLET STAINLESS DOOR POST STRIKER PLATES

Original or even the replacement door strikers are not very attractive. Replace yours with these beautiful polished billet pieces and your open doors will look like jewelry. Hardware included.

1955-57 #19389.....\$284.95/pr.

DOOR POST STRIKER PLATES

These install on the "B" pillar and contact the door latch assembly to keep the door closed. One pair does two doors.



1955-59, 56-60 Vette..... #1847.....\$44.95/pr.

DOOR STRIKER SHIMS

These help line up the striker plate to the latch assembly, used as needed.



1955-57 Driver..... #12325.....\$7.95/ea.

1955-57 Passenger..... #12326.....\$7.95/ea.



DOOR POST STRIKER LOCK PLATES

These mount under the striker plates and help keep them in place. One set will do two striker plates. One installs at the top, one at the bottom.

1955-57 #12324..... \$13.95/set

DOOR POST STRIKER SCREWS

One set per car. **Made in the USA.**



1955-57 2-Door & 56-62 Vette #10253..... \$10.95/set

1955-57 4-Door #10253A..... \$14.95/set

SMOOTH DOOR LOCK KNOBS

These polished CNC machined billet aluminum door lock knobs are the perfect finishing touch for your classic. 6-40 thread and 1-5/8-inch tall.



All..... #18598.....\$25.95/pr.



ORIGINAL STYLE DOOR LOCK KNOBS



Made to look like the originals but produced from billet aluminum. These door lock knobs are made in the good old USA by Danchuk. Available in either regular billet or a beautiful chrome plating. **Made in the USA.**

1955-57 Billet..... #14656\$22.95/pr.

1955-57 Chrome #14656A\$32.95/pr.



DOOR LOCK KNOBS



5-6-7 owners don't have to settle for cheap auto parts store replacement door lock knobs! We've made these repros available in the original colors. **Made in the USA.**

1955-57 Black #329.....\$8.95/pr.

1955-57 Red..... #329A.....\$8.95/pr.

1955-57 Yellow..... #329B.....\$8.95/pr.

1955-57 Dark Blue #329C.....\$8.95/pr.

1955-57 Turquoise #329D.....\$8.95/pr.

1955-57 Green..... #329E.....\$8.95/pr.

1955-57 Sierra Gold..... #329F\$8.95/pr.

1955-57 Light Blue..... #329G.....\$8.95/pr.



UPPER DOOR HINGES WITH WIRE CHANNELS

Woody's Hot Rodz 1955-57 custom upper door hinges are designed to allow easy and clean routing of wires to your door, especially useful with power windows. Simply route wires through the milled groove in the top of the hinge and then screw on the cap with included screws. The stock-style hinge fits all 1955-57 Chevrolet sedan, hardtop, convertible and wagon models. Hinges are sold as a pair, one for each front door.

1955-57 #18128..... \$329.95/pr.



DOOR JAMB REINFORCEMENTS

Fits 2-Door hardtops and convertibles. With minor modifications can be used on 2-Door sedans.

1955-57 Driver #10199..... \$151.95/ea.
1955-57 Passenger #10200..... \$151.95/ea.



FRONT DOOR HINGE TO DOOR BOLTS

Enough for all four hinges.

1955-57 #2062..... \$11.95/set



FRONT DOOR HINGE BACKING PLATES

Door hinge backing plate is the threaded plate that the door hinge gets mounted to and is installed behind the door hinge inside of the A-pillar. 1955-56 require two, while the 1957 requires four.

1955-56 Upper..... #16834..... \$13.95/ea.
1955-56 Lower..... #16835..... \$11.95/ea.
1957..... #16836..... \$11.95/ea.



REAR DOOR HINGE SCREWS

Enough for one hinge.

1955-57 4-Door #1483..... \$11.95/set



FRONT DOOR HINGE TO PILLAR SCREWS

One set does all four hinges.

1955-57 #970..... \$5.95/set



POLISHED ALUMINUM DOOR LOCK KNOBS

1940-57 w/ Plain Head..... #10057A..... \$30.95/pr.



DOOR HINGE PIN

These install in the door hinge along with the door hinge bushings #4821. Replacement of these pins along with new bushings will take up the play in your door hinges. One per hinge required.

1955-57 #1565..... \$1.95/ea.



DOOR HINGE BUSHING

These are used with the door hinge pins #1565 to take up the play in your door hinge. Two per hinge required.

1938-72 #4821..... \$2.95/ea.

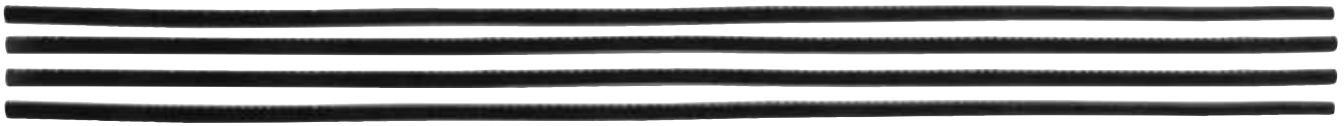

FLIPPER RELINING KIT

Installs with adhesive, one set does both flippers.

1955-57 2-Door Hardtop..... #12406..... \$54.95/kit

DOOR FLIPPERS



PLASTIC FLIPPER LEVER COVERS

Prevents scratching of the vent window frame assembly.

1955-57 2-Door Hardtop..... #10161..... \$6.95/pr.



FLIPPER SPRINGS

One of the cleverest solutions for the hardtop is the flipper unit. Don't let your flipper springs go neglected. Weak springs defeat the purpose of the flipper, never allowing it to close completely. These are must replace items.

1955 2-Door Hardtop..... #149A..... \$11.95/set

1956-57 2-Door Hardtop..... #149..... \$9.95/set

DOOR FLIPPER STOPS AT REAR

This is the rear flipper seal, which mounts inside the flipper opening. Mounted by rearmost flipper screw. Tab faces forward while the opening faces out.



1955-57 2-Door Hardtop..... #832..... \$14.95/pr.



FLIPPER AND REAR WINDOW FUR CHANNEL SCREW SET

1955-57 2-Door Hardtop..... #2071..... \$9.95/set



FLIPPER RIVETS

1955-57 2-Door Hardtop..... #12719..... \$4.95/set



PHOTO COURTESY OF GERTMAN2000

FLIPPER SEALS 

Without the flipper seal the flipper is noisy and practically useless. Keep the drafts and noise out, and allow the flipper to do the job it was designed for. Rolled edge overhangs top of flipper to the outside.

Made in the USA.

1955-57 2-Door Hardtop..... #840.....\$19.95/pr.



DOOR AND SIDE WINDOW ACCESS HOLE COVERS

1955-57 Hardtop..... #2979..... \$85.95/set
 1955-57 Sedans..... #15039..... \$91.95/set
 1955-57 Convertible..... #2978..... \$85.95/set

DOOR FLIPPER STOPS AT FRONT

Mounts inside flipper opening and is held in by glue and by forward-most flipper screw. Open side faces in, while front lower flap sits against windshield pillar.

1955-57 2-Door Hardtop..... #831.....\$17.95/pr.



SEDAN DOOR UPPER ACCESS PLUGS

1955-57 #833.....\$5.95/pr.

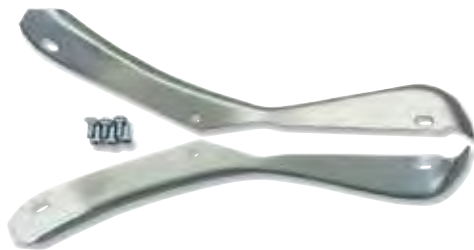

REAR DOOR RUBBER PLUG

This plug covers the access hole for the door handle screw. Two needed per car.

1956-57 4-Door Hardtop..... #828.....\$3.95/ea.



COWL SIDE DRAIN GUTTERS

Don't let the interior of your car be damaged for the lack of a simple part. The cowl side drain gutter prevents water from leaking through the door, keeping your carpet and door panel cardboard dry.

1955-57 #2073.....\$19.95/pr.



INNER DOOR ACCESS PANEL SCREWS

1955-57 #2896..... \$14.95/set

4-DOOR RUBBER BUMPERS 

Doors need these bumpers to close securely and keep from rattling. Part #806 also serves as the liftgate on body rubber bumper for 5-6-7 station wagons.

Made in the USA.

1955-57 Sedan #805..... \$3.95/ea.

1956-57 Hardtop..... #806..... \$4.95/ea.

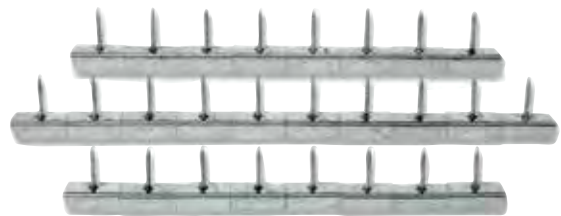
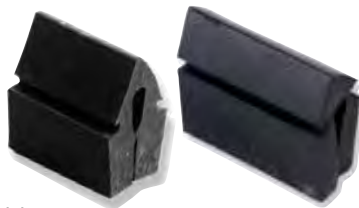

DOOR PANEL CLIP AND NAIL SET

26-Piece. 4-door models require two sets.

1955-57 #078..... \$21.95/set



DOOR BELT MOULDING SCREWS

1955-57 (exc. Sedan & Wagon)... #1028..... \$2.95/set



DOOR PANEL TRIM

STAINLESS STEEL INTERIOR DOOR PANEL TRIM KITS O/S

These kits are a must for those re-upholstering their interiors or just bringing back that original look. All of the kits below are complete, including both front doors and rear quarter trim, or rear door trim, as applicable.

1955 Nomad	#11318.....	\$681.95/set	1956 210 2-Door Sedan	#11323.....	\$208.95/set
1955 Convertible.....	#1437.....	\$404.95/set	1956 Bel Air 4-Door Sedan	#11324.....	\$323.95/set
1955 Del Ray 2-Door Sedan	#2043.....	\$174.95/set	1956 Bel Air 2-Door Sedan	#1438.....	\$324.95/set
1955 210 2-Door Sedan	#2042.....	\$174.95/set	1956 Bel Air 2-Door Hardtop	#2037.....	\$324.95/set
1955 Bel Air 2-Door Hardtop	#1436.....	\$404.95/set	1956 Bel Air 4-Door Hardtop	#2039.....	\$324.95/set
1955 Bel Air 2-Door Sedan	#1911.....	\$365.95/set	1957 Nomad	#2041.....	\$404.95/set
1955 Bel Air 4-Door Sedan	#11319.....	\$404.95/set	1957 Convertible.....	#1397.....	\$404.95/set
1955 Nomad Lower Door Waffle Trim	#17761.....	\$107.95/ea.	1957 210 2 Door Sedan.....	#2044.....	\$324.95/set
1956 Nomad	#2040.....	\$345.95/set	1957 210 4-Door Sedan	#2045.....	\$324.95/set
1956 Bel Air Convertible.....	#2038.....	\$324.95/set	1957 Bel Air 2 Door Hardtop	#1396.....	\$404.95/set
1956 Del Ray 2-Door Sedan	#11320.....	\$182.95/set	1957 Bel Air 2-Door Sedan	#1439.....	\$244.95/set
1956 210 2-Door Hardtop	#11321.....	\$208.95/set	1957 Bel Air 4-Door Hardtop	#1440.....	\$404.95/set
1956 210 4-Door Hardtop	#11322.....	\$208.95/set	1957 Del Ray 2-Door Sedan	#11325.....	\$208.95/set
			1957 Bel Air 4 -Door Sedan	#11326.....	\$244.95/set

DOOR PANEL ATTACHING STRIP

Welds to inner door sheet metal and holds the bottom edge of the door panel.

1955-57



INTERIOR DOOR GARNISH CLIPS

These install under the door interior garnish moulding. One goes at the front of the door and the interior garnish gets screwed into it. The second mounts midway on the top inner area of the door to support the moulding in the center. Two pairs required per car.

1955-57 2-Door Hardtop & Conv. . #974.....\$9.95/pr.



DOOR WEATHERSTRIP RETAINERS AND SCREWS

This is a must for every door weatherstrip replacement job. These retainers and screws also fit wagon and Nomad tailgates. Use as needed. **Made in the USA.**

1955-57



INTERIOR DOOR PANEL TRIM JOINER CLIPS

1955 2 & 4-Door Bel Air

1957 2 & 4-Door 210

1957 2 & 4-Door Hardtop, Convertible & Nomad

.....

.....

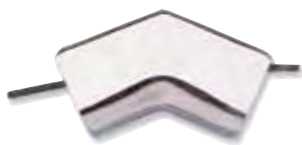

DOOR WINDOW UPPER MOULDING CLIPS

Mounts the moulding above the door glass. End clips not included. One set does two doors.

1955-57 Bel Air Sedan, 2 & 4-Door



DAKOTA DIGITAL COMMANDER KEYLESS ENTRY BASE SYSTEMS

The Commander 10K offers modern conveniences of keyless entry, trunk release and can be expanded up to 10 functions such as remotely opening and closing power windows, doors, trunk etc.

- All 10-Channel #15116..... \$199.95/ea.
- All 10-Channel, with 2 PDR-1 Actuators (Shown)..... #15117..... \$279.95/ea.
- All 10-Channel, with 3 PDR-1 Actuators #15118..... \$299.95/ea.



DAKOTA DIGITAL DOOR ACTUATORS

Extra door actuators will be required when expanding the Commander 10K System. The 10-pound version is typically used in door applications. The 35-pound version is for applications that require more force.

- All 10-Lb. Force..... #15121 \$39.95/ea.
- All 35-Lb. Force, w/ Relay & Hardware #15122..... \$81.95/ea.



POWER KEYLESS REMOTE DOOR LOCK CONVERSION KIT

This kit adds the convenience and safety of modern keyless entry to your classic. The keyless entry module comes with onboard relays for a clean installation, two-two button remote controls, two door lock actuators with 15 lbs. of pull and built in overload protection, two actuator mounting brackets, two rubber door jamb boots, two actuator connecting rods and clips, wire harness, full color step by step instruction manual, and all necessary hardware.

- 1955-57 #18720\$259.95/kit



DAKOTA DIGITAL RELAY KITS

Extra relays may be needed when expanding the functions of the Commander 10K system or can be used with fan controllers in dual fan applications.

- All 30 Amp, Single..... #15119..... \$11.95/kit
- All 30 Amp, Dual..... #15120..... \$29.95/kit

2-DOOR FRONT WINDOW REGULATOR ASSEMBLIES

- 1955-57 Hardtop, Convertible, Driver #11214..... \$94.95/ea.
- 1955-57 Hardtop, Convertible, Passenger #11215..... \$94.95/ea.
- 1955-57 Sedan, Nomad & Wagon, Driver #11216..... \$94.95/ea.
- 1955-57 Sedan, Nomad & Wagon, Passenger #11217..... \$94.95/ea.



2-DOOR REAR WINDOW REGULATOR ASSEMBLIES

- 1955-57 Hardtop, Driver #12402..... \$94.95/ea.
- 1955-57 Hardtop, Passenger #12403..... \$94.95/ea.
- 1955-57 Sedan, Driver #12404..... \$94.95/ea.
- 1955-57 Sedan, Passenger #12405..... \$94.95/ea.
- 1955-57 Convertible, Driver #16200..... \$99.95/ea.
- 1955-57 Convertible, Passenger .. #16201..... \$99.95/ea.

4-DOOR HARDTOP FRONT WINDOW REGULATOR ASSEMBLIES

- 1956-57 Driver..... #17307..... \$116.95/ea.
- 1956-57 Passenger..... #17308..... \$116.95/ea.



VENT WINDOW REGULATORS

- Mounting screws included.
- 1955-57 Driver..... #14864..... \$77.95/ea.
 - 1955-57 Passenger..... #14865..... \$77.95/ea.

WINDOW REGULATOR GEAR PLATES

If the teeth are worn or chipped on your gear plate you'll notice the strain and slipping when rolling up the window. This part is easily replaced when overhauling the window assembly.



- 1955-57 2-Door Hardtop & Conv., Front Only, 20 Teeth #953..... \$24.95/ea.
- 1955-57 2 & 4-Door Sedan, Nomad & Wagon, Front Only 23 Teeth..... #954..... \$24.95/ea.

WINDOW REGULATOR GROMMETS

- This foam grommet surrounds the door and window handle spring and provides a cushion between the door panel and the door. Four per set. **Made in the USA.**
- 1955-57 #827..... \$8.95/set





POWER WINDOW CONVERSION KITS

1955-57 2-Windows, Nomad, Hardtop & Convertible.....	#14846.....	\$438.95/kit
1955-57 2-Windows, Sedan Delivery.....	#14847.....	\$438.95/kit
1955-57 2-Windows, 2-Door Wagon.....	#14848.....	\$438.95/kit
1955-57 2-Windows, 2-Door Sedan.....	#14849.....	\$438.95/kit
1955-57 4-Windows, 2-Door Hardtop	#14850.....	\$834.95/kit
1955-57 4-Windows, 2-Door Sedan & Wagon (Shown).....	#14851.....	\$834.95/kit
1955-57 4-Windows, 2-Door Convertible	#14852.....	\$863.95/kit
1955-57 4-Windows, Universal, 4-Door Sedan & Wagon	#14853.....	\$834.95/kit
1955-57 2-Windows, 2-Door Sedan w/ Vent Removed	#14854.....	\$446.95/kit
1955-57 4-Windows, 2-Door Sedan w/ Vent Removed	#14855.....	\$854.95/kit



VENT WINDOW POWER CONVERSION KIT

This kit is the perfect addition to your power window conversion.

1955-57	#14214.....	\$498.95/kit
---------------	-------------	--------------



POWER WINDOW

POWER WINDOW BUTTON SWITCHES, ORIGINAL STYLE

When purchasing these switches, pigtails shown below, are necessary. Switches include retainers. These are not a direct replacement for original switches.

- 1955-57 4-Button..... #11356..... \$84.95/ea.
- 1955-57 Single Button..... #11357..... \$59.95/ea.
- 1955-57 2-Button..... #11358..... \$99.95/ea.

WINDOW REGULATOR ROLLERS AND RIVETS



If these parts are missing or cracked, window operations cease to exist. Three required per window; 12 per car. **Made in the USA.**



- 1955-57 1/4" Rivet..... #1001..... \$2.95/ea.
- 1955-57 5/16" Rivet..... #11287..... \$4.95/ea.



WINDOW REGULATOR SCREWS

One set mounts two regulators.

- 1955-57 8-Piece..... #15434..... \$4.95/set

UPPER DOOR HINGES WITH WIRE CHANNELS

Woody's Hot Rodz 5-6-7 custom upper door hinges are designed to allow easy and clean routing of wires to your door, especially useful with power windows. Simply route wires through the milled groove in the top of the hinge and then screw on the cap with included screws. Provides a clean look when the door is open and hides the ugly wires that would usually show. The stock-style hinge fits all 5-6-7 Chevrolet sedan, hardtop, convertible and wagon models. Hinges are sold as a pair, one for each front door.



- 1955-57 #18128..... \$329.95/pr.



POWER WINDOW SWITCH RETAINERS AND LOCKS

Not for use with original power window switches.

- 1955-57 4-Button..... #11359..... \$9.35/ea.
- 1955-57 2-Button..... #11359A..... \$9.95/ea.
- 1955-57 Single Button..... #11360..... \$5.95/ea.



STAINLESS FLEXIBLE WIRE CONDUITS

These conduits are a clean solution for running wires between the doors and A-pillar for power window or keyless entry systems.

- All 5/8" w/ Bushings..... #15156 \$36.95/ea.
- All 3/4" w/ Bushings..... #15157..... \$36.95/ea.

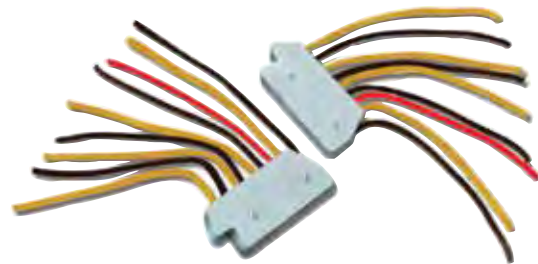

POWER WINDOW SWITCH PIGTAILS

For use with power window switches, parts #11356-11358, only.

- 1955-57 4-Button..... #11356A..... \$43.95/ea.
- 1955-57 Single Button..... #11357A..... \$16.95/ea.
- 1955-57 2-Button..... #11358A..... \$32.95/ea.



POWER WINDOW WIRE CONDUIT

- 1955-57 #11355..... \$48.95/set



SIDE WINDOW UPPER AND LOWER MOULDING CLIPS

Includes all clips and screws to attach the beltline and window area stainless trim.

- 1955-57 Bel Air 2-Door Sedan #2263..... \$84.95/set
- 1955-57 Bel Air 4-Door Sedan (Shown)
..... #2264..... \$106.95/set



WINDOW MOULDING CONNECTORS

Made in the USA*.

- 1955-57 exc. 1955 150, Best, Lower Windshield #2056* \$13.95/ea.
- 1955-57 exc. 1955 150 Good, Lower Windshield #16807..... \$6.95/ea.
- 1955-57 exc. 1955 150 & Conv., exc. 56-57 Conv., Upper Windshield #2057* \$13.95/ea.
- 1955-57 Sedan, 2-Door Hardtop, Best Lower Rear #2058* \$13.95/ea.
- 1955-57 Sedan, 2-Door Hardtop, Good, Lower Rear #16808..... \$6.95/ea.
- 1956-57 4-Door Hardtop, Lower Rear #2059* \$13.95/ea.



REAR WINDOW MOULDING CLIPS

These clips mount the rear window moulding, sometimes called the "reveal moulding."

- 1955-57 #247..... \$8.95/set

REAR QUARTER UPPER WINDOW MOULDING CLIPS

Attaches ONLY the moulding above the quarter glass. One set does both sides. Included in part #2263.

- 1955-57 Bel Air 2-Door Sedan #1076..... \$21.95/set



REAR QUARTER WINDOW MOULDING CLIPS

Attaches the moulding above and below the rear quarter side glass. Upper and lower. One set does both sides. Included in part # 2263.

- 1955-57 Bel Air 2-Door Sedan #1077..... \$23.95/set

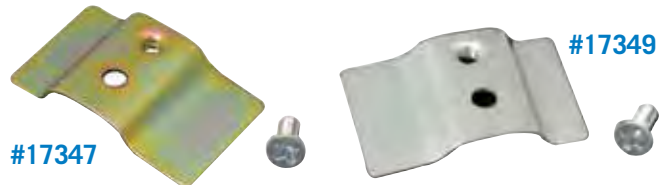

SEDAN UPPER DOOR GLASS MOULDING END CLIPS

For use with Danchuk #940 door upper moulding clips on page 620.

- 1955-57 Driver Front #17347..... \$4.95/ea.
- 1955-57 Driver Rear #17348..... \$4.95/ea.
- 1955-57 Psngr. Front..... #17349..... \$4.95/ea.
- 1955-57 Psngr. Rear #17350..... \$4.95/ea.



SEDAN LOWER DOOR GLASS MOULDING END CLIPS

- 1955-57 Driver Front, Pass. Rear . #17351..... \$5.25/ea.
- 1955-57 Driver Rear, Pass. Front.. #17352..... \$5.25/ea.

DOOR WINDOW MOULDING SCREWS

One set does 2 doors.

- 1955-57 2 & 4-Door Sedan, Lower #19281..... \$3.95/set



WINDOW FUR CHANNEL KITS

Daily window use has usually worn those old fur channels to the point where the windows are loose, and may even rattle. Each kit of our "fuzzies" contains all of the parts you need to completely replace your window channels. We've reproduced these kits with all the correct contours and lengths. The exposed beaded edges of the channels are made of polished stainless steel, just like the factory originals. The hardtop kit does not include the upper portion of the roof line contour, available under part #2070, shown at right. **Made in the USA***.

- 1955-57 2-Door Hardtop..... #172*\$129.95/kit
- 1955-57 2-Door Sedan #174* ^{O/S}\$239.95/kit
- 1955-57 2-Door Wagon #178* ^{O/S}\$239.95/kit
- 1956-57 4-Door Hardtop..... #173*\$129.95/kit
- 1955-57 4-Door Sedan #175* ^{O/S}\$239.95/kit
- 1955-57 4-Door Wagon (Shown).. #179* ^{O/S}\$239.95/kit
- 1955-57 Convertible..... #176*\$129.95/kit
- 1955-57 Nomad #177* ^{O/S}\$179.95/kit
- 1955-57 Sedan Delivery, Utility Sedan
..... #174A ^{O/S}\$139.95/kit
- 1955-57 2-Door Sedan w/ No Vent Windows
..... #174B ^{O/S}\$239.95/kit
- 1955-57 2-Door Sedan, Utility Sedan w/ No Vent
Windows #174C ^{O/S}\$169.95/kit



FUR CHANNEL TRACKS

This track holds the fur channel in place at the front of the rear quarter window on your 2-door sedan and wagon.

- 1955-57 Vertical Post, 2-Door Sedan & Wagon
..... #15767\$21.95/pr.



WINDOW RUNNERS ^{O/S}

These pre-bent window runner fur channels come with the original style "Rosebud" Retaining clips pre-attached ready to install. Front Door runners also work on 2-door wagons.
1955-57, Quarter, 2-Door Sedan... #18105.....\$209.95/pr.
1955-57 Door, 2-Door Sedan..... #18106.....\$209.95/pr.
**1955-57 Front Door, 4-Door Sedan
 #18679.....\$169.95/pr.**

REAR WINDOW CORNER MOULDINGS



This Danchuk reproduction is made of stainless steel, with the threaded clip welded in place. This is an exact duplication of the original.

- 1955-57 2-Door Hardtop..... #161\$21.95/pr.
- 1955-57 Sedan (Shown)..... #162.....\$21.95/pr.

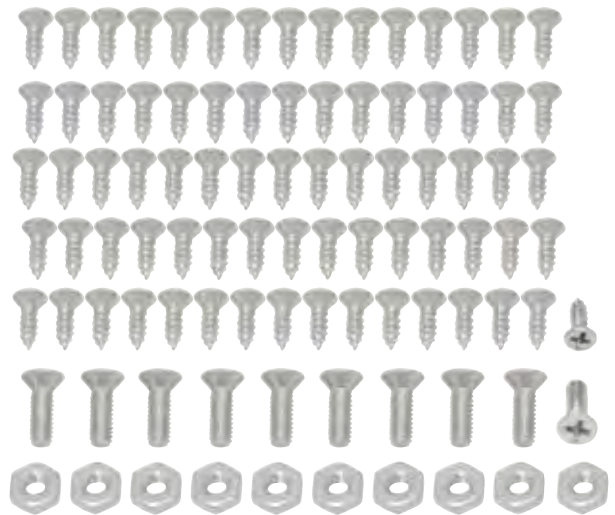

FUR CHANNEL SCREW KIT

- 1955-57 #13349.....\$7.95/kit



WINDOW RELINING KIT

This kit fits the upper portion of the rear. Mounting glue is included.

1955-57 2-Door Hardtop..... #2070..... \$47.95/kit



WINDOW PILLAR SPACER CAPS

These molded rubber pillar caps are often missing or need replacement. They mount on the center interior pillar cover on 2-door wagons. One 4-piece set required.

1955-57 #15534 \$31.95/set



WINDOW ADJUSTING PLATES AND HARDWARE

Located in the door jamb just outside the weatherstrip, this allows you to adjust the vertical glass run channel inside the door. Includes #846 adjusting seal. One set does two doors.

1955-57 2-Door Hardtop, Nomad & Conv.
..... #1164..... \$12.95/set



U-CHANNEL GUIDE

Track for the fur channel located to the rear of the front door on two-door models and on the front doors on 4-door models. Can be modified to work on rear quarter glass on 2 and 4-door front doors.

1955-57 Sedan & Wagon..... #12698..... \$12.95/ea.



WINDOW CHANNEL ADJUSTING SEALS

Replacement seals for the window adjustment plates. One set does two doors. **Made in the USA.**

1955-57 2 & 4-Door Hardtop, Conv., & Nomad
..... #846..... \$4.95/pr.



FRONT DOOR WINDOW ADJUSTING PLATE SET

Located outside the door weatherstrip on the front doors. Includes hardware and seal. One set does two doors.

1956-57 Hardtop, 4-Door..... #18930..... \$16.95/set



PHOTO COURTESY OF GERTMAN2000



WINDSHIELD VISORS O/S

These reproduction sheetmetal visors capture the trend of the times and add a retro touch to your classic Chevy.

1955-57 Sedan & Wagon.....	#18446.....	\$599.95/ea.
1955-57 Hardtop & Nomad	#18447.....	\$649.95/ea.

WINDOW RELATED



REAR WINDOW MOULDINGS

O/S

1955-57 Upper, Sedan.....	#17949.....	\$139.95/ea.
1955-57 Lower, Sedan.....	#17950.....	\$229.95/ea.
1955-57 3-Piece, Sedan.....	#17951.....	\$329.95/set

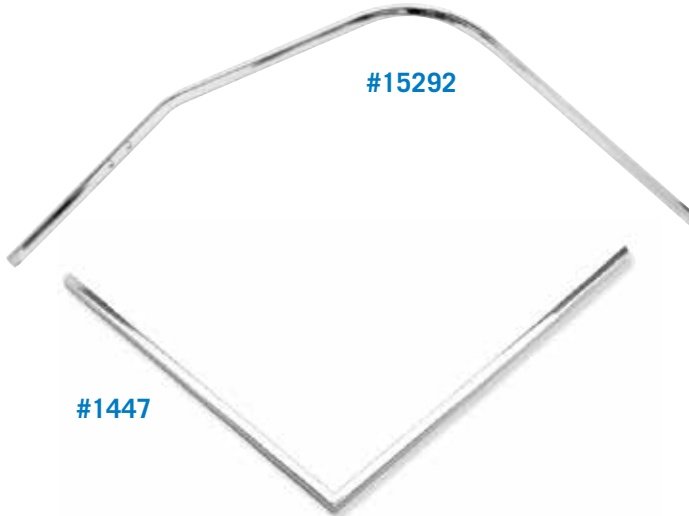

CHROME DOOR WINDOW FRAMES O/S

Get rid of the years of wear and weather with these beautiful reproduction window frames.

1955-57 2-Door Hardtop & Convertible, Either Side	#1447.....	\$73.95/ea.
1955-57 Nomad & Safari, Upper, Either Side	#15292.....	\$79.95/ea.



LOWER WINDSHIELD TO DASH GARNISH TRIM



1955-57 Painted	#16146.....	\$129.95/ea.
-----------------------	-------------	--------------



NOMAD SLIDER GLASS STAINLESS EDGE MOULDINGS

1955-57	#18326.....	\$124.95/pr.
---------------	-------------	--------------



NOMAD STATIONARY GLASS MOULDINGS

These are the moldings that install on the front edge of the curved quarter glass and include the felt pre-installed.

1955-57 w/ Felt.....	#15541	\$144.95/pr.
----------------------	--------------	--------------



UPPER WINDSHIELD MOULDINGS O/S

1955-57 Hardtop & Nomad, Driver & Passenger.....	#17952.....	\$154.95/pr.
1955-57 Sedan & Wagon, Driver.....	#19148.....	\$75.95/ea.
1955-57 Sedan & Wagon, Passenger	#19149.....	\$75.95/ea.

LOWER WINDSHIELD MOULDINGS O/S

1955-56 Driver, Except 150	#18182.....	\$65.95/ea.
1955-56 Passenger, Except 150	#18183.....	\$65.95/ea.
1957 Driver.....	#18184.....	\$65.95/ea.
1957 Passenger	#18185.....	\$65.95/ea.

CORNER WINDSHIELD MOULDINGS

1955-57 Driver.....	#15618.....	\$59.95/ea.
1955-57 Passenger	#15619.....	\$59.95/ea.

1957 LOWER WINDSHIELD GASKET CHANNELS O/S

1957 2-Piece	#17907.....	\$61.95/pr.
--------------------	-------------	-------------



HARDTOP REAR WINDOW MOULDINGS O/S

1955-57 2-Door Hardtop, Upper	#14987.....	\$148.95/ea.
1955-57 2-Door Hardtop, Lower, Left & Right.....	#14987A.....	\$231.95/pr.
1955-57 2-Door Hardtop, 3-Piece Set (Shown)	#14987B.....	\$331.95/set



CONVERTIBLE INSIDE TOP WINDSHIELD MOULDINGS

1955-57 #19422 \$144.95/pr.

#2056



#2059

#2057

#2058

WINDSHIELD/REAR WINDOW MOULDING CONNECTORS



Our moulding connectors include all the original contours, ensuring a correct and easy installation. Replace your pitted and scratched originals with these quality stainless steel connectors. Corner mouldings available on page 626. **Made in the USA*.**

- 1955-57 exc. 1955 150, Best, Lower Windshield #2056* \$13.95/ea.
- 1955-57 exc. 1955 150 Good, Lower Windshield #16807 \$6.95/ea.
- 1955-57 exc. 1955 150 & Conv., exc. 56-57 Conv., Upper Windshield #2057* \$13.95/ea.
- 1955-57 Sedan, 2-Door Hardtop, Best Lower Rear #2058* \$13.95/ea.
- 1955-57 Sedan, 2-Door Hardtop, Good, Lower Rear #16808 \$6.95/ea.
- 1956-57 4-Door Hardtop, Lower Rear #2059* \$13.95/ea.

WINDSHIELD GUTTER INNER COWL PANEL DRAIN SEALS

Whenever replacing glass, the drain seal should be inspected, and replaced if necessary. After 60 years this drain seal is often cracked, clogged, or both.



- 1955 (Shown) #802 \$15.95/pr.
- 1956-57 #803 \$15.95/pr.

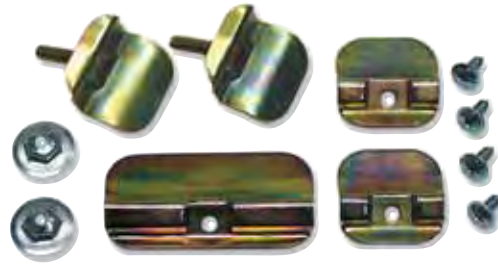

WINDSHIELD MOULDING CLIPS

This set mounts the lower windshield moulding. Use with part # 015A, shown below, to complete your installation. 1955-57 #015 \$12.95/set



WINDSHIELD CORNER MOULDING CLIPS

This set mounts the windshield moulding corner escutcheon. 1955-57 #015A \$9.95/set



INTERIOR LOWER WINDSHIELD CENTER CONNECTOR MOULDINGS



Installs on the front lower center windshield garnish moulding. **Made in the USA.**

- 1955-57 #10319 \$8.95/ea.
- 1955-57 Chrome #10319A \$16.95/ea.



WINDSHIELD SEALS

Body shops, glass shops, painters, and restorers all agree that there is no substitute for our windshield seals. The fit is an absolute match to the original part, and our high quality rubber formulas make these longer lasting than the original Chevrolet versions. Part #568 has no provision for trim. **Made in the USA.**

- 1955-57 All exc. 1955 150 #567..... \$52.95/ea.
- 1955 150 (No Chrome) #568..... \$49.95/ea.



WINDSHIELD PILLAR SEALS

Top quality rubber, new precision molds, and careful research are combined to produce the best sealing, best fitting windshield pillar seal available. Includes plastic installation clips. We recommend 3M weatherstrip adhesive for installation. **Made in the USA.**

- 1955-57 Hardtop, Convertible & Nomad #245..... \$9.95/pr.



INTERIOR PILLAR WEATHERSTRIP CHANNEL MOULDINGS

These install on the back side of the windshield pillar. The vent window frame closes against these parts.

- 1955-57 Convertible... #16141. \$77.95/pr.

PLATED WINDSHIELD PILLAR SCREW SET

The cad plate finish ensures these screws will hold moulding in place, yet be camouflaged from view.

- 1955-57 #070..... \$3.25/set



WINDSHIELD WIPER ESCUTCHEONS

These install around the wiper transmissions where they protrude through the cowl. The nuts hold the transmissions in place against the back of the cowl. Part #208 is used on 1955 150 which has no windshield chrome.

Made in the USA.

- 1955 150..... #208..... \$49.95/set
- 1955-56 (exc. 55-150)..... #210A..... \$49.95/set
- 1957 (Shown) #210..... \$49.95/set



WIPER SAVERS

Wiper savers install on the wiper transmissions when you do not mount wiper blades. Available in two styles, original snub nosed and bullet, both show chrome plated and ready to install. **Made in the USA.**

- All..... #1922..... \$19.95/pr.
- All Bullet Style..... #12621..... \$27.95/pr.

WIPER ESCUTCHEON NUT TOOL

We've upgraded this tool to include the T-handle, making our new version even more convenient to use. Don't worry about losing the handle; it's pressure fit into the tool. With this handy implement escutcheon nuts are easily removed, and scratched hardware is a thing of the past.

- 1953-58 #912..... \$14.95/ea.



WINDSHIELD WIPER WASHER CONTROL CABLE AND HEADLIGHT SWITCH NUT TOOL

- 1955-57 Wiper Switch..... #913..... \$16.95/ea.
- 1957 Headlight Switch #913..... \$16.95/ea.



SHOW QUALITY WIPER ARMS

If the best quality and most correct configuration is what you're after, then these are the wiper arms for you.

1955-56 Vacuum/Electric (exc. '56 Delco), Hook.....	#10137.....	\$56.95/pr.
1957 Vacuum, Hook	#10138.....	\$62.95/pr.
1957 Electric, Straight End	#10139.....	\$56.95/pr.
1955-57 Wiper Blades for Hook End Arms	#17416.....	\$16.95/ea.



POLISHED STAINLESS STEEL WIPER ARMS

Bring the highly polished look back to your windshield wipers with these stainless steel wiper arms. For use with our wiper blades 2518L and 2518R below.

1954-59 Driver.....	#2519.....	\$23.95/ea.
1954-59 Passenger	#2520.....	\$23.95/ea.



POLISHED STAINLESS STEEL WIPER BLADES

This is the blade that belongs on our highly-polished wiper arms, the combination you need to restore your car back to its original look. For use with our #2519 and #2520 wiper arms.

1954-59 Driver.....	#2518L.....	\$23.95/ea.
1954-59 Passenger	#2518R.....	\$23.95/ea.



WINDSHIELD WIPER PIVOT RIVETS

With the introduction of our stainless steel windshield wiper arm pivot rivet, it is now possible to disassemble, rechrome and reassemble the wiper arm assembly for that factory fresh look.

1955-57, '53-62 Vette	#1553	\$2.95/pr.
-----------------------------	-------------	------------



WINDSHIELD WIPER MOTOR SLIDES

Since these under-the-hood connections are plastic, they are prone to heat deterioration and discoloration. Don't let them break unexpectedly. This is a low-cost item that should be replaced regularly. Part #211B is a plastic adapter to be used with #211A for vehicles with factory washer bottles.

1957 & 56-62 Vette	#211	\$9.95/ea.
1955-56 Best	#211A.....	\$8.95/ea.
1955-56 Good	#16768.....	\$5.95/ea.
1955-56 Adapter	#211B.....	\$7.95/ea.



REPLACEMENT ELECTRIC WIPER MOTORS

Bolts to factory wiper motor location and works with original wiper transmissions.

1955-56 2-Speed Switch	#11224.....	\$246.95/ea.
1955-56 Intermittent Switch	#11224A...	\$349.95/ea.
1957 2-Speed Switch w/ Extension	#11225.....	\$274.95/ea.
1957 Intermittent Switch w/ Extension	#11225A...	\$377.95/ea.



DUAL WINDSHIELD WIPER KITS

These kits feature 2-speeds and a standard 72-inch drive cable. Motor mounts under the dash.

1955-57 Intermittent Switch	#2776.....	\$309.95/kit
1955-57 (Shown)	#2777.....	\$362.95/kit

WIPER TRANSMISSIONS

Planning on retaining the factory wiper drive system? These new wiper transmissions are a must. No more searching for usable cores or dealing with damaged or stretched cables. These units replace your original wiper transmissions.



1955-56	#18107.....	\$240.95/pr.
1957.....	#18108.....	\$240.95/pr.

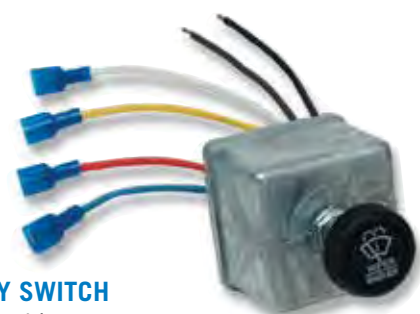

INTERMITTENT DELAY SWITCH

For aftermarket wiper kits.

1955-57	#11226.....	\$117.95/ea.
---------------	-------------	--------------

#12221



#12321



BEL AIR WINDSHIELD WIPER KNOBS

1955.....	#12221.....	\$13.95/ea.
1956.....	#12321.....	\$17.95/ea.
1957.....	#886.....	\$14.95/ea.



1957 WIPER SWITCH CONTROL CABLE ASSEMBLY

1957 w/ Stainless Cable	#16601.....	\$79.95/ea.
-------------------------------	-------------	-------------



TRICO VACUUM WIPER MOTOR GASKETS

1955-57	#11219.....	\$3.75/kit
---------------	-------------	------------

WIPER SWITCH RETAINER NUTS

This often missing retainer is now available, Be sure to order the correct tool, part #913 on page 631, to install.



#17953



#15546

1955-56	#17953.....	\$12.95/ea.
1957.....	#15546.....	\$3.95/ea.

WIPER MOTOR AND DRIVE MOUNTING SCREWS

1955-57 ..	#2267 ...	\$4.95/set
------------	-----------	------------



WARNING! Products on these pages may contain chemicals known to the State Of California to cause cancer and/or birth defects or reproductive harm. www.p65warnings.ca.gov



RAINGEAR WINDSHIELD WIPER KITS

The RainGear wiper system is a rugged and proven lever and link wiper system designed to completely replace the original cable and spool system. This kit uses the original arms and blades and you can use the original knob and bezel to retain originality. Don't forget to order the optional washer kit, #12828, shown below. These kits will not clear Airtique's 1955 only defrost duct or Kugels under dash master cylinder/booster. Motor mounts under the dash.

1955-56 2-Speed	#12824.....	\$476.95/kit
1955-56 2-Speed w/ Delay	#12825.....	\$537.95/kit
1957 2-Speed	#12826.....	\$537.95/kit
1957 2-Speed w/ Delay.....	#12827.....	\$569.95/kit



WIPER TRANSMISSION SPACERS

These die cast spacers are required when re-installing the factory wiper transmission in the cowl area.

1955-56	#17683.....	\$21.95/pr.
---------------	-------------	-------------



RAINGEAR WINDSHIELD WASHER KIT

Add this washer kit to your RainGear system for a complete modern upgrade.

All.....	#12828.....	\$105.95/kit
----------	-------------	--------------

1957 WIPER MOTOR CABLE RETAINER

This mounts to the front of the wiper motor and retains the wiper control cable #16001. Also fits 1957-1962 Corvette.



1957.....	#17406.....	\$13.95/ea.
-----------	-------------	-------------

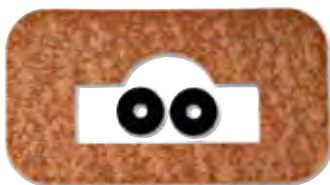

WINDSHIELD WIPER CENTER DRIVE GASKETS

Made in the USA.

1955-57	#863.....	\$7.95/set
---------------	-----------	------------

DIVISION BAR CHANNEL STOPS

Mounts at the top of the vent window frame in the division bar and acts as a stop when you roll up the window.

1955-57 2 & 4-Dr Hardtop, Conv., & Nomad

.....	#147.....	\$12.95/pr.
-------	-----------	-------------





GLASS METAL CHANNELS

There were more than one design for some channels; therefore, some of the channels listed below may not look exactly like the ones in your car. Minor modification may be necessary for some models. Channels are designed to fit all 55-57 model years. Glass setting channels, shown at right, are needed to complete your installation. For those of you who are planning to delete the Vent windows on your 2-door sedan or wagon, part #16522 will make the job easier. This setting channel is made extra long to properly fit the wider door glass on vent delete applications. Part #16522 fits both sides, two required per car.

- 1955-57 Hardtop & Conv., Front, Driver (Shown) #1011 \$24.95/ea.
- 1955-57 Hardtop & Conv., Front, Psngr. (Shown) #1012 \$24.95/ea.
- 1955-57 Nomad, Driver #1013 \$24.95/ea.
- 1955-57 Nomad, Passenger #1014 \$24.95/ea.
- 1955-57 2-Door Sedan & Wagon, Front, Driver #1015 \$21.95/ea.
- 1955-57 2-Door Sedan & Wagon, Front, Passenger #1016 \$21.95/ea.
- 1955-57 2-Door Sedan, Rear, Driver #1017 \$29.95/ea.
- 1955-57 2-Door Sedan, Rear, Passenger #1018 \$29.95/ea.
- 1955-57 2-Door Sedan & Wagon, Vent Delete, Both Sides #16522 \$21.95/ea.
- 1955-57 2-Door Wagon, Rear, Driver #11301 \$25.95/ea.
- 1955-57 2-Door Wagon, Rear, Passenger #11302 \$25.95/ea.
- 1955-57 4-Door Sedan & Wagon, Front, Driver #1019 \$19.95/ea.
- 1955-57 4-Door Sedan & Wagon, Front, Passenger #1020 \$19.95/ea.
- 1955-57 4-Door Sedan & Wagon, Rear, Driver #1021 \$19.95/ea.
- 1955-57 4-Door Sedan & Wagon, Rear, Passenger #1022 \$19.95/ea.

QUARTER GLASS TRACK "L" STOP

This mounts on the quarter glass channel and keeps the glass from moving too far in the channel keeping the glass in place. One per side, two per car required.



- 1955-57 2-Door Hardtop & Sedan #12705 \$12.95/ea.



GLASS SETTING CHANNELS



The glass setting channel is an absolute must when installing glass. With this important part, glass can be safely and securely pressure-fitted into the glass metal channel, shown at right. One set per car required. **Made in the USA.**
 1955-57 Sedan & Wagon (Shown) #842 \$26.95/set
 1955-57 2-Door Hardtop & Conv. . #843 \$26.95/set
 1955-57 Nomad #844 \$26.95/set



REAR OF DOOR VERTICAL GLASS RUN CHANNELS

This is the guide channel that mounts inside of the door and gets lined with fur channel material.
 1955-57 2-Door Hardtop & Conv. Driver #15990 \$38.95/ea.
 1955-57 2-Door Hardtop & Conv. Passenger #15991 \$35.95/ea.



REAR GLASS DRAIN SEALS

- 1955-56 Sedan #815 \$14.95/pr.
- 1956-57 4-Door Hardtop, Trim to Fit '57 Sedan #816 \$14.95/pr.

REAR GLASS TRACK ADJUSTMENT BOLT

This specially designed bolt assembly secures the short and long inner quarter window glass tracks to the inner quarter panels and allows for adjustment of the quarter windows.



- 1955-57 Hardtop #17409 \$7.95/ea.



#11337

#11338

#11339

#11340

GLASS TRACK ROLLER GUIDES

These mount to the glass metal channels and the window rollers run inside. Part #11340 can also be used on 2-door wagon with minor modifications.

1955-57 Front, 2-Door	#11337.....	\$23.95/ea.
1955-57 Rear Quarter, 2-Door Sedan & Wagon	#11338.....	\$23.95/ea.
1955-57 Front, 4-Door Sedan & Wagon	#11339.....	\$24.95/ea.
1955-57 Rear, 4-Door Sedan & Wagon	#11340.....	\$24.95/ea.



1957 BOTTOM WINDSHIELD GASKET CHANNELS

1957 2-Piece.....	#17907.....	\$61.95/pr.
-------------------	-------------	-------------



WINDOW ROLLER GUIDES WITH HARDWARE

1955-57 Inner, Hardtop, Convertible & Nomad	#14970.....	\$11.95/ea.
1955-57 Hardtop, Convertible & Nomad	#2082.....	\$14.95/ea.



WINDOW ROLLER RUBBERS

Replacement rubber rollers for the inner and outer window roller guides. Set of four.

1955-57 Hardtop, Convertible, & Nomad	#088.....	\$7.95/set
---	-----------	------------



NOMAD DOOR GLASS UPPER WINDOW STOP KIT
 1955-57 #18293.....\$23.95/kit



UPPER WINDOW STOPS
 These are the rubber caps that install on the window stop metal adjusters.
1955-57 2 & 4-Door Hardtop, Conv., & Nomad
 #830..... \$9.95/set



INSIDE TOP WINDOW STOP SET
 These mount inside the door at the top and act as a stop for the window and allow for adjustment to the upward travel. One set required per door. Hardtop and convertible only, will not work on sedans.
1955-57 Hardtop & Convertible.... #2193..... \$27.95/set



WINDOW BOTTOMING STOPS
 These are located inside the door at the bottom. They install in a bracket in the door and keep the window from clunking when rolled down.
1955-59 Hardtop & Conv. (Shown) #184.....\$8.95/pr.
1955-59 Sedan & Wagon..... #16695.....\$3.95/pr.



INSIDE WINDOW STOP KITS
 These mount inside the door at the top and act as a stop for the window and allow for adjustment to the upward travel. One set required per front door, two sets required per car. One set required for rear doors, two sets required per car.
1956-57 4-Door Hardtop, Front Doors
 #18294.....\$23.95/kit
1956-57 4-Door Hardtop, Rear Doors
 #18295.....\$11.95/kit



PHOTO COURTESY OF GERTMAN2000



CONVERTIBLE QUARTER WINDOW PIVOT ASSEMBLY

Provides mounting and pivot points for the chrome quarter window frames. Comes with pivot brackets, adjuster plates, studs, bolts and washers. One set required.

1955-57 #15218.....\$271.95/pr.



QUARTER WINDOW WEATHERSTRIP RETAINER

1955-57 Hardtop & Convertible.... #11354..... \$24.50/ea.



CHROME REAR QUARTER WINDOW UPPER FRAMES

1955-57 2-Door Hardtop..... #11299..... \$64.95/ea.

1955-57 Convertible..... #2190..... \$91.95/ea.

CONVERTIBLE QUARTER WINDOW ADJUSTING PLATES

Fits between the pivot assembly and the inner quarter panel.

1955-57 Driver..... #11229..... \$18.95/ea.

1955-57 Passenger #11230..... \$18.95/ea.



QUARTER WINDOW RIVETS

1955-57 Hardtop & Convertible.... #12717..... \$4.25/set

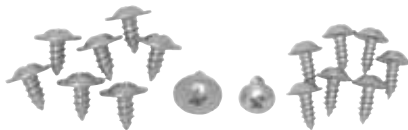

INNER QUARTER WINDOW CURVED MOULDING SCREWS

1955-57 2-Door Hardtop..... #19303..... \$3.95/set

#854



#855

REAR QUARTER WINDOW STOPS

These rear window stops mount in the opening on the "B" pillar at the top by the belt area above the door striker plate. #854 includes the metal steel insert. One set required per car.

1955-57 2-Door Hardtop..... #854.....\$20.95/pr.

1955-57 Conv. #855.....\$14.95/pr.

QUARTER PANEL, QUARTER GLASS "L" STOP

This quarter glass 'L' stops installs on the inner quarter and helps keep the quarter glass in place. Sold as each, two needed per car. Includes the bracket, square nut, bolt and lock washers.

1955-57 2-Door Hardtop..... #18029\$9.95/ea.



REAR QUARTER DRAIN AND UPPER RUBBER STOP BUMPERS

These mount in the top of the quarter at the rear of the window opening. They mount down in the channel of the body. One pair needed per car.

1955-57 Convertible..... #856..... \$32.95/set



NOMAD AND WAGON CURVED QUARTER GLASS RETAINER CLIPS

1955-57 Upper, 8-Piece #15430..... \$21.95/set

1955-57 Lower, 10-Piece #15431 \$24.95/set



CHROME QUARTER WINDOW FRAMES O/S

1955-57 2-Door Hardtop, Upper & Lower.....	#12370.....	\$459.95/set
1955-57 Best, Convertible, Upper & Lower	#16813.....	\$399.95/set
1955-57 Good, Convertible, Upper & Lower	#12371.....	\$349.95/set

#17922



#17923

#17921

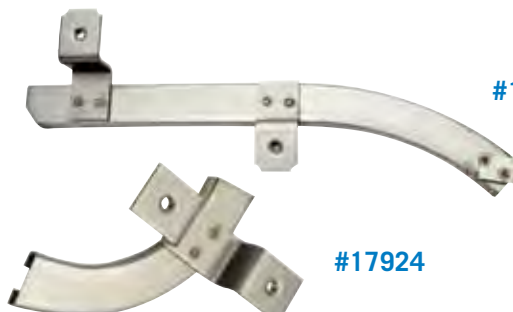

#17924

REAR QUARTER GLASS TRACKS

Installs in the rear quarters and guides the quarter windows on 2-door hardtops and sedans.

1955-57 Hardtop, Small, Driver.... #17921	\$33.95/ea.	1955-57 Hardtop, Long, Driver	#18721	\$44.95/ea.
1955-57 Hardtop, Small, Psngr. ... #17922.....	\$33.95/ea.	1955-57 Hardtop, Long, Psngr.....	#18722.....	\$44.95/ea.
1955-57 Sedan, Small, Driver..... #17923.....	\$29.95/ea.	1955-57 Sedan, Long, Driver	#18723.....	\$44.95/ea.
1955-57 Sedan, Small, Passenger #17924.....	\$29.95/ea.	1955-57 Sedan, Long, Passenger. #18724.....	\$44.95/ea.	

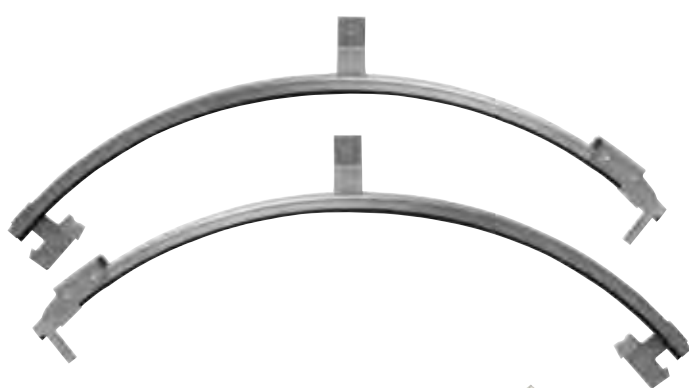

CONVERTIBLE QUARTER WINDOW TRACKS

These window tracks come fully lined and ready for installation. **Made in the USA.**

1955-57 Stainless.....	#17309.....	\$225.95/pr.
------------------------	-------------	--------------



CONVERTIBLE QUARTER WINDOW TRACKS

This curved quarter channel guide mounts inside the rear quarter and guides quarter window down inside rear body and comes with the felt liner installed.

1955-57 Driver.....	#16479.....	\$124.95/ea.
1955-57 Passenger	#16480.....	\$124.95/ea.



VENT WINDOW ASSEMBLIES

These are complete vent window assemblies which includes the fixed window frame, vent window frame, tinted or smoked vent window glass vertical run channels and the vent window seal.

- 1955-57 Hardtop, Clear, Driver #18179 \$359.95/ea.
- 1955-57 Hardtop, Clear, Psngr..... #18180 \$359.95/ea.
- 1955-57 Hardtop, Tinted, Driver #18953 \$359.95/ea.
- 1955-57 Hardtop, Tinted, Psngr #18954 \$359.95/ea.
- 1955-57 Hardtop, Smoked, Driver #18955 \$359.95/ea.
- 1955-57 Hardtop, Smoked, Psngr..... #18956 \$359.95/ea.
- 1955-57 Sedan & Wagon, Clear, Driver #17431 \$359.95/ea.
- 1955-57 Sedan & Wagon, Clear, Psngr..... #17432 \$359.95/ea.
- 1955-57 Sedan & Wagon, Tinted, Driver..... #18961 \$359.95/ea.
- 1955-57 Sedan & Wagon, Tinted, Psngr #18962 \$359.95/ea.
- 1955-57 Sedan & Wagon, Smoked, Driver .. #18963 \$359.95/ea.
- 1955-57 Sedan & Wagon, Smoked, Psngr .. #18964 \$359.95/ea.
- 1955-57 Conv., Clear, Driver #18268 \$359.95/ea.
- 1955-57 Conv., Clear, Psngr #18269 \$359.95/ea.
- 1955-57 Conv., Tinted, Driver #18957 \$359.95/ea.
- 1955-57 Conv., Tinted, Psngr..... #18958 \$359.95/ea.
- 1955-57 Conv., Smoked, Driver..... #18959 \$359.95/ea.
- 1955-57 Conv., Smoked, Psngr #18960 \$359.95/ea.
- 1955-57 Nomad, Clear, Driver..... #18900 \$359.95/ea.
- 1955-57 Nomad, Clear, Psngr #18901 \$359.95/ea.
- 1955-57 Nomad, Tinted, Driver #18965 \$359.95/ea.
- 1955-57 Nomad, Tinted, Psngr..... #18966 \$359.95/ea.
- 1955-57 Nomad, Smoked, Driver..... #18967 \$359.95/ea.
- 1955-57 Nomad, Smoked, Psngr #18968 \$359.95/ea.

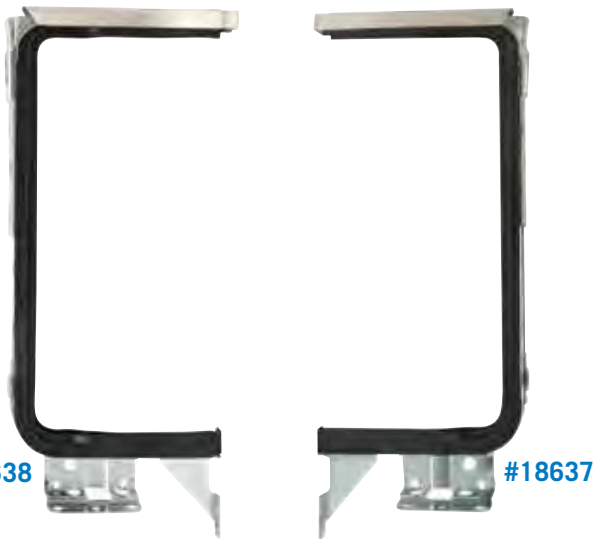

OUTER VENT WINDOW FRAMES

These reproduction fixed, vent window frames fit hardtop and convertible models come with the rubber vent window seal.

- 1955-57 Hardtop & Conv., Driver #18637..... \$179.95/ea.
- 1955-57 Hardtop & Conv., Psngr . #18638..... \$179.95/ea.

OUTER VENT WINDOW FRAMES

- 1955-57 2 & 4-Door Sedan, Wagon, Driver #17234..... \$119.95/ea.
- 1955-57 2 & 4-Door Sedan, Wagon, Passenger #17235..... \$119.95/ea.



VENT DELETE WINDOW CHANNEL KITS

Vent window delete has become the trend on both 2 and 4-door sedans and wagons. One kit does both sides, not available for hardtop models. Ground shipping only.

1955-57 2-Door	#16640.....	\$89.95/kit
1955-57 4-Door	#16641.....	\$89.95/kit



VENT WINDOW FRAMES

1955-57 w/ Latch, Sdn. & Wagon. #11210.....	\$152.95/pr.
1955-57 w/ Latch, HT & Nomad ... #11212.....	\$134.95/pr.
1955-57 Convertible..... #11213.....	\$99.95/pr.



VENT WINDOW VERTICAL MOULDINGS

1955-57 HT, Conv. & Nomad, Driver .. #17917 ..	\$48.95/ea.
1955-57 HT, Conv. & Nomad, Psngr... #17918 ..	\$48.95/ea.
1955-57 Sedan & Wagon, Driver..... #17919 ..	\$48.95/ea.
1955-57 Sedan & Wagon, Psngr. #17920 ..	\$48.95/ea.



VENT WINDOW LATCH ASSEMBLY

1955-57 exc. Convertible	#10251	\$29.95/pr.
---------------------------------------	---------------------	--------------------

VENT WINDOW VERTICAL FRAME CHANNELS WITH FELT AND SEAL

1955-57 Hardtop & Conv., Driver ... #18266 ..	\$115.95/ea.
1955-57 Hardtop & Conv., Psngr. #18267 ..	\$115.95/ea.
1955-57 Sedan, Driver	#18413 .. \$115.95/ea.
1955-57 Sedan, Passenger.....	#18414 .. \$115.95/ea.



VENT WINDOW FRAME CAPS

- 1955-57 2-Door Hardtop, 1955 Convertible & Nomad #15514..... \$21.95/ea.
- 1956-57 4-Door Hardtop, Convertible & Nomad #16953..... \$54.95/pr.
- 1956-57 4-Door Hardtop, Convertible & Nomad, Driver #16954..... \$29.95/ea.
- 1956-57 4-Door Hardtop, Convertible & Nomad, Psngr. #16955..... \$29.95/ea.



VERTICAL WINDOW SEALS

These seals slide into the channel in the rear quarter window and seal the quarter window to the door window keeping out wind, dirt and rain. These can be trimmed to fit 56-57 4-door hardtops. **Made in the USA.**

- 1955-57 2-Door Hardtop & Convertible (Shown) #566..... \$10.95/pr.



VENT WINDOW ASSEMBLY SCREWS

- 1955-57 Hardtop, Conv & Nomad. #15422 \$12.95/set
- 1955-57 Sedan & Wagon..... #15423..... \$4.95/set



VENT WINDOW FRAME LOCK AND PIVOT BRACKET RIVETS

- 1955-57 #12718..... \$2.95/set



VENT WINDOW SEALS

Danchuk vent window seals are made from the finest rubber formulas available today and are an exact fit to the factory originals.

- 1955-57 Best, Hardtop, Convertible & Nomad #565..... \$69.95/set
- 1955-57 Good, Hardtop, Convertible & Nomad #16710..... \$52.95/set
- 1955-57 Best, Sedan & Wagon (Shown) #565A..... \$69.95/set
- 1955-57 Good, Sedan & Wagon ... #16711 \$52.95/set



SIDE AND VENT WINDOW FRAME SCREWS

- 1955-57 Hardtop, Convertible & Nomad #1075..... \$4.95/set



VENT WINDOW ASSEMBLY ADJUSTER BOLTS

This is the adjuster bolt that attaches to the lower stem of the vent window assembly. One for each door required, two per car.

- 1955-57 Sedan & Wagon..... #17404..... \$9.95/ea.
- 1955-57 Hardtop, Nomad & Conv. #17405..... \$9.95/ea.



NOMAD REAR QUARTER GLASS SEALS

1955-57 #651 \$6995.00/pr.

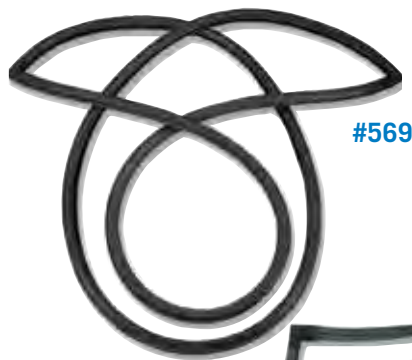

#569

#627



WAGON REAR QUARTER GLASS SEALS

Made in the USA.

1955-57 2-Door Wagon #849 \$64.95/pr.
 1955-57 4-Door Wagon (Shown) .. #850 \$69.95/pr.



REAR WINDOW SEALS

When you replace the glass or paint your car you need to replace the window seals too. Our top quality seals are designed to outlast the originals. **Made in the USA***.

1955 2 & 4-Door 150 Sedan #572* *\$54.95/ea.
 1955 2 & 4-Door 210 & Bel Air Sedan #570* \$52.95/ea.
 1956-57 Sedan #839 \$69.95/ea.
 1956-57 4-Door Hardtop #569A* \$59.95/ea.
 1955-57 2-Door Hardtop (Shown). #569* \$52.95/ea.
 1955-57 Wagon & Sedan Delivery #571* \$26.95/ea.
 1955-57 Nomad (Shown) #627 \$35.95/ea.



LOWER DOOR DRAIN SEALS

These seals are removed to drain the water out of the door. If your seals are rotted, painted over or missing, we've got your replacements. Clips are included. Two sets required for 4-door models. **Made in the USA.**

1955-57 #841 \$11.95/set



REAR QUARTER SIDE GLASS SEAL

This seal is designed to replace the stationary rear and center rear windows on the 150 and 210 models. **Made in the USA.**

1955-57 4-Door Sedan #997 \$79.95/pr.



TRUNK SEALS

#563



Our trunk seals all require glue-in installations, just like the originals. For an excellent bond, we recommend 3M weatherstrip adhesive. In 1957, Chevy added nylon fastening clips to the design for more secure positioning. Our reproduction weatherstrip includes this important upgrade. Careful research, state-of-the-art rubber formulas, and precision tooling make these Danchuk seals the best value available. **Made in the USA*.**

1955-56 Best.....	#562*	\$34.95/ea.
1955-56 Good.....	#16779.....		\$19.95/ea.
1957 Best.....	#563*	\$35.95/ea.
1957 Good.....	#16780.....		\$22.95/ea.



DOOR SEALS WITH MOLDED ENDS

Our modern rubber formulas ensure that you are buying the longest lasting seal available. This 100% accurate door seal is held in position by nylon fasteners. Stamped steel supports are molded into the end clips, just like they were designed by Chevrolet. This show quality part is as close as you can get to the original. We recommend using 3M weatherstrip adhesive for installation. **Made in the USA.**

1955-57 Best, 2-Door Hardtop & Convertible (Shown)	#914.....	\$119.95/pr.
1955-57 Nomad.....	#2091.....	\$78.95/pr.
1956-57 4-Door Hardtop, Front	#12264.....	\$82.95/pr.
1956-57 4-Door Hardtop, Rear.....	#12265.....	\$82.95/pr.

REAR LIFTGATE SEAL



Designed for the sedan delivery, this seal includes the original-style fastening clips. We recommend using 3M weatherstrip adhesive for installation.



Made in the USA.

1955-57.....	#039.....	\$26.95/ea.
--------------	-----------	-------------



DOOR SEALS WITH CLIPS

Our 100% accurate reproduction door seals fit all 1955, 1956, and 1957 Chevy sedans and wagons. They seal the doors just as well, and include the nylon fasteners that hold the seal in place, but lack the molded ends used on the original 2-door hardtop and convertible door seal (#914). For 4-door models, you will need two sets. All Danchuk seals are manufactured with the best rubber, tooling, and craftsmanship available. We recommend using 3M weatherstrip adhesive for installation. **Made in the USA*.**

1955-57 Best, Sedan & Wagon, 55-57 Truck	#552*.....	\$64.95/pr.
1955-57 Good, Sedan & Wagon, 55-57 Truck	#16708.....	\$31.95/ea.
1955-57 Hardtop, Convertible & Nomad	#553*.....	\$64.95/pr.



3M BLACK SUPER WEATHERSTRIP ADHESIVE

Bonds gaskets and weatherstripping to metal surfaces. It withstands vibration and temperature changes; resists oils, fuels, detergents and grease to provide a strong and flexible bond. Danchuk recommends 3M weatherstrip adhesive always be used when you replace your door and trunk seals. 5 oz. tube. Ground shipping only.

All 5 oz.....	#036.....	\$13.95/ea.
---------------	-----------	-------------



ROOF RAILS  O/S

Seal out that wind, water, dirt, and noise with these beautiful rubber seals. In our never-ending struggle for perfection, we made “Class A” tooling for our Nomad & Safari (#296) seals. These incredible seals are made of the highest quality USA rubber and, of course, fitted with the original style metal inserts. We give these seals our highest quality control rating and we are certain you will too. **Made in the USA.**

1956-57 4-Door Hardtop.....	#628.....	\$299.95/pr.
1955-57 Nomad & Safari.....	#296.....	\$169.95/pr.



#223



#224



DOOR HINGE SEALS WITH CLIPS

Our new tooling has made the tolerances on this door seal 100% correct and original. We use only top quality rubber formulas on all our rubber parts. Fits along the slanted portion of the front door near the hinge. We recommend using 3M weatherstrip adhesive for installation.

1955-57	#246.....	\$16.95/pr.
---------------	-----------	-------------

RUBBER BUMPER KITS

These kits contain bumpers for the doors, trunk, glove box and hood. Nomad kits do not include tailgate bumpers, #1822, found on page 654.

1955-57 2-Door Sedan (Shown)...	#224.....	\$14.95/kit
1955-57 4-Door Sedan	#224A.....	\$20.95/kit
1955-57 2-Door Wagon	#224B.....	\$16.95/set
1955-57 4-Door Wagon	#224C.....	\$19.95/set
1955-57 2-Door Hardtop, Conv. & Nomad (Shown)		
.....	#223.....	\$14.95/kit
1955-57 4-Door Hardtop.....	#223A.....	\$15.95/kit



NOMAD VERTICAL SLIDER SEALS 

Designed specifically for Nomad slide-open side windows. **Made in the USA.**

1955-57	#1210.....	\$21.95/pr.
---------------	------------	-------------



NOMAD REAR SLIDING WINDOW AND SEAT LATCH BUMPERS

1955-57 Nomad & Safari	#814.....	\$3.95/pr.
------------------------------	-----------	------------



SEDAN DELIVERY REAR DOOR TORSION BARS

1955-57 #17407 \$119.95/pr.



NOMAD STAINLESS PAINT DIVIDER FILLER TRIM

1956..... #18332..... \$158.95/pr.



NOMAD VERTICAL SLIDER GLASS MOULDINGS

1955-57 #14700..... \$129.95/pr.



NOMAD DOOR ANTI-RATTLE TRIM AND FUR STRIPS

Although not original, these add-on anti-rattle trim and fur strips will help minimize door glass rattle. Originally, the front doors on the Nomad only had a fur strip on the inside of the door against the glass. These install on the outside between the door window channel and the glass.

1955-57 #18331..... \$84.95/pr.



NOMAD STAINLESS WINDOW FUR CHANNEL SLIDER BRACKETS

These install in the sliding window channel at the rear of the curved rear window on the inside. They include the slider stop, part #814.

1955-57 Nomad & Safari #15021..... \$43.95/pr.



NOMAD REAR INTERIOR WINDLACE GARNISH
1955-57 #18329 \$99.95/pr.



NOMAD STAINLESS, REAR QUARTER GLASS BRACKETS #15027
With minor modifications these brackets will work on all station wagons.
1955-57 Inside, Lower, Nomad & Safari #15027 \$79.95/pr.



NOMAD STAINLESS REAR QUARTER GLASS BRACKETS
1955-57 Inside Upper, Nomad & Safari
..... #15025 \$59.95/pr.



NOMAD GLASS SLIDER LATCHES
1955-57 Nomad & Safari #14945 \$39.95/pr.

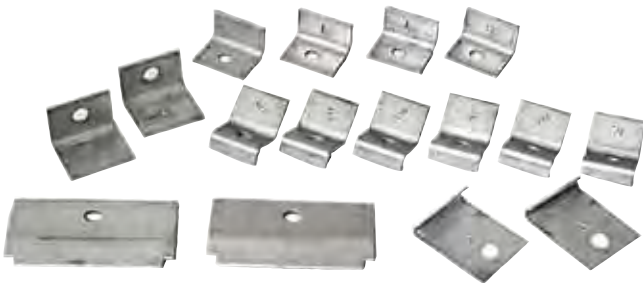

NOMAD STAINLESS WINDOW CLIPS
1955-57 Nomad & Safari #15026 \$59.95/kit



NOMAD REAR QUARTER GLASS SEALS
1955-57 #651 \$69.95/pr.

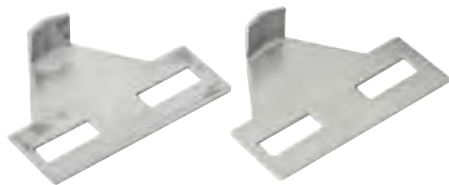

NOMAD STAINLESS SLIDER GLASS LOCK BRACKETS
1955-57 Nomad & Safari #15028 \$24.95/pr.

NOMAD SLIDER GLASS CHANNEL LOCATING CLIPS

Can be used on 150 Sedans rear stationary windows, and stationary center windows on wagons.



1955-57 6-Piece #15429 \$24.95/set



PHOTO COURTESY OF GERTMAN2000



NOMAD AND WAGON STAINLESS LIFTGATE ANTI-RATTLE TRIM WITH CNC STRIKER O/S

Custom one-piece design eliminates the rivets for the center striker plate, which is the primary cause of liftgate rattling. The 14 gauge trim is stamped with factory bends and includes adjustment plate on the backside for the striker. Piece comes with all stainless hardware and Dynamat for additional sound deadening ready to install. CNC machined stainless striker is polished and comes with stainless hardware. Will not break or chip like original potmetal strikers.

1955-57 #18333..... \$335.95/ea.

LIFTGATE



NOMAD AND WAGON CNC MACHINED STAINLESS LIFTGATE STRIKERS

1955-57 Polished..... #18325.....\$117.95/pr.



#17608



#17609

NOMAD & WAGON CHROME LIFTGATE SUPPORTS

1955-57 Wagon #17608.....\$199.95/pr.
1955-57 Nomad #17609.....\$199.95/pr.



NOMAD AND WAGON LIFTGATE GUIDE

1955-57, Nomad, Wagon & Safari #15024..... \$84.95/ea.



NOMAD CARGO AREA ACCESS COVER

1955-57 #17413.....\$7.95/ea.



NOMAD SIDE WINDOW MOULDING SCREWS

1955-57 60-Piece..... #15425 \$7.95/set



NOMAD AND WAGON CARGO AREA ASSEMBLY KIT

1955-57 256-Piece..... #11307.....\$26.95/kit



NOMAD INNER LIFTGATE WINDOW FRAME SCREWS

1955-57 56-Piece..... #15428 \$9.95/set



NOMAD AND WAGON POLISHED STAINLESS LIFTGATE GAS STRUT KITS

Convert your original locking liftgate arms to these polished stainless liftgate gas struts. Stainless brackets and screws included.

1955-57 Nomad	#18339.....	\$255.95/kit
1955-57 Wagon	#18340.....	\$255.95/kit



NOMAD & WAGON POLISHED STAINLESS LIFTGATE RUBBER RETAINERS

This is the piece that installs on the vertical stainless on the rear C-pillar to the left and right side of the liftgate. These keep the liftgate rubber from pulling out of the channel.

1955-57	#18330.....	\$94.95/pr.
---------------	-------------	-------------



LIFTGATE ARM REBUILD KIT

All the parts you need to rebuild your lift gate arms (supports) back to their original state. All parts are dimensionally accurate and the support tabs are chrome plated per the original design. **Made in the USA.**

1955-57 Nomad & Wagon.....	#1463.....	\$18.95/kit
----------------------------	------------	-------------



NOMAD UPPER LIFTGATE TABS

Located on the ends of the upper liftgate, these reproduction tabs look like the originals and fit like them too!

1955-57	#613.....	\$19.95/pr.
---------------	-----------	-------------

#199



#183

LIFTGATE STOP RUBBER BUMPERS

Protects the lower tailgate if the liftgate is accidentally closed over it.

1955-57 Wagon	#183.....	\$5.95/ea.
1955-57 Nomad	#199.....	\$8.95/pr.



STAINLESS LIFTGATE SCREW KIT

1955-57 Nomad & Safari	#15029.....	\$64.95/kit
------------------------------	-------------	-------------



LIFTGATE WINDOW RETAINER CLIPS

1955-57 exc. Nomad, 4-Piece	#15432	\$23.95/set
-----------------------------------	--------------	-------------



WAGON TAILGATE HINGES

1955-57 #17898.....\$132.95/pr.



#18324



BILLET ALUMINUM TAILGATE HINGES WITH STAINLESS HARDWARE

1955-57 Nomad #18323.....\$299.95/pr.

1955-57 Wagon #18324.....\$299.95/pr.



NOMAD TAILGATE HINGE COVERS

1955-57 Stainless..... #18436.....\$150.95/pr.



NOMAD AND WAGON TAILGATE HINGE TRIM

Finishes the raw edge of the tailgate skin at the lower hinges. Snaps in as original.

1955-57 #16889.....\$59.95/pr.

1955-57 Polished Stainless #18328.....\$99.95/pr.

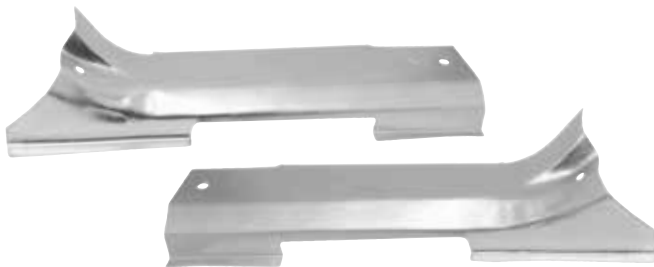

WAGON TAILGATE HINGE COVERS

This reproduction of the original, mounts on the tailpan and covers the hinge screws.

1955-57 #16877.....\$81.95/pr.



LOWER TAILGATE HINGE COVERS

1955-57 Nomad, Wagon & Safari. #15020.....\$24.95/pr.

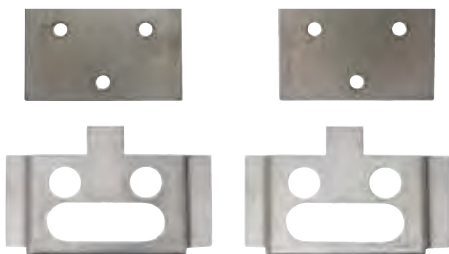

NOMAD AND WAGON LOWER TAILGATE HINGE MOUNTING PLATES

A complete set of replacement lower tailgate mounting plates. Retainers will require welding to install.

1955-57 w/ Holders..... #17679.....\$99.95/pr.



NOMAD INNER TAILGATE STAINLESS TRIM

1955-57 5-Piece..... #18336..... \$225.95/set

STAINLESS TAILGATE LATCHES

These brand new tailgate latches are machined out of stainless steel and polished to a show quality shine. Comes complete with stainless rods, clips and stainless hardware.

1955-57 Nomad w/ Rods & Hardware #18455 \$249.95/pr.
 1955-57 Wagon w/ Rods & Hardware #18456 \$249.95/pr.



LOWER TAILGATE HANDLE TO LATCH RODS

These often missing parts are now available in a kit that includes the rods and clips to connect the tailgate handle to the latches.

1955-57 Nomad w/ Clips #15539..... \$21.95/kit



STAINLESS TAILGATE LATCH RODS

1955-57 Wagon & Sedan Delivery w/ Clips..... #18341..... \$49.95/ea.

NOMAD AND WAGON TAILGATE LATCHES

These brand new latches include the spring, latch and brilliantly chrome plated housing.

1955-57 #18498..... \$129.95/pr.



#1247

NOMAD TAILGATE CLIPS

Sold in five piece sets, these clips securely mount the unique "bananas", found exclusively on the Nomad. See the Exteriors section for the tailgate bars. One set does one bar. Seven sets required.

1955-57 One Bar, 5-Piece #1247 \$16.95/set
 1955-57 Complete, 33-Piece #15426 \$79.95/set



#15428

TAILGATE ROD CLIPS

These clips attach the tailgate latch rods at both ends and are often rusty, damaged or missing. One set required.

1955-57 Nomad, Lower #15540..... \$3.50/set





LIFTGATE AND TAILGATE SEALS



This part fits both the liftgate and the tailgate on all wagons, and the tailgate on Nomads. We recommend using 3M weatherstrip adhesive for installation. Two seals required for wagons and one required for Nomads. **Made in the USA.**
 1955-57 #615..... \$34.95/ea.



NOMAD AND WAGON TAILGATE STRIKERS & LATCHES

1955-57 #18781..... \$179.95/pr.



WAGON UPPER LIFTGATE SEAL

1955-57 w/ Correct Molded Ends

..... #14150..... \$72.95/ea.



NOMAD AND WAGON TAILGATE STRIKERS

1955-57 Stainless w/ Hardware ... #18791..... \$249.95/pr.
 1955-57 Chrome #18780..... \$69.95/pr.



NOMAD LIFTGATE SEAL

This weatherstrip is applied to the body opening. We recommend using 3M weatherstrip adhesive for installation.

1955-57 #614..... \$35.95/ea.

#16832



NOMAD AND WAGON TAILGATE STRIKER COVERS

The striker cover finishes off the tailgate and replaces missing or damaged originals.

1955-57 Chrome #16832..... \$33.95/ea.
 1955-57 Stainless..... #17598..... \$41.95/ea.

REAR LIFTGATE SEAL



Designed for the sedan delivery, this seal includes the original-style fastening clips. We recommend using 3M weatherstrip adhesive for installation. **Made in the USA.**

1955-57 Sedan Delivery #039..... \$26.95/ea.



NOMAD LIFTGATE WEATHERSTRIP

This weatherstrip was originally applied to Nomad liftgates by dealers as a repair part. We recommend using 3M weatherstrip adhesive for installation.

1955-57 #2036..... \$9.95/ea.



TAILGATE SEALS

These tailgate seals feature molded corners.

1955-57 Nomad #11222 \$74.95/ea.
 1955-57 Wagon #11223 ... \$72.95/ea.



NOMAD AND WAGON BILLET STAINLESS TAILGATE CABLE GUIDES W/ SCREWS

These polished stainless tailgate cable guides will outlast any chromed reproduction or originals. Machined from billet 304 stainless for strength and longevity. Opening and closing the tailgate a thousand times with these installed showed very minimum wear. Includes installation hardware. Will also fit Safari. Sold as a pair, 1 pair needed per car.
1955-57 #18904.....\$249.95/pr.



LOWER TAILGATE BALL COVERS WITH CLIPS

1955-57 Nomad, Wagon & Safari #15023..... \$62.95/ea.

NOMAD AND WAGON STAINLESS TAILGATE CABLE BALLS AND BALL COVERS

1955-57 w/ Stainless Hardware ... #18322..... \$129.95/pr.



LOWER TAILGATE BALLS

1955-57 Nomad, Wagon & Safari. #15022.....\$59.95/pr.



NOMAD AND WAGON TAILGATE CABLE RETRACTOR

Danchuk reproduces these exactly per original right here in the USA. We added a zinc plate on the housing for corrosion protection. **Made in the USA.**

1955-57 #1058.....\$57.95/ea.
1955-57 Cable Clevis Pin #1058AA\$4.95/ea.

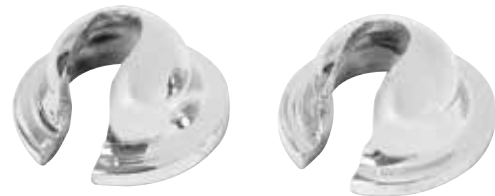

NOMAD AND WAGON CABLE GUIDES

These are the cast iron guides that bolt into the rear body to guide the tailgate cables.

1955-57 #17408.....\$44.95/pr.

TAILGATE CABLES

Replace your worn and frayed originals with these beautiful Danchuk reproductions, correct in every detail. **Made in the USA.**

1955-57 Nomad, 45-1/2" #221 \$29.95/ea.
1955-57 Wagon, 36-3/4" #221A \$34.95/ea.



NOMAD AND WAGON TAILGATE REEL BRACKETS

These mount on the inside wall above the rear wheel wells, right behind the rear seat. The tailgate retractors, #1058 bolt to these brackets.

1955-57 #17412.....\$29.95/pr.

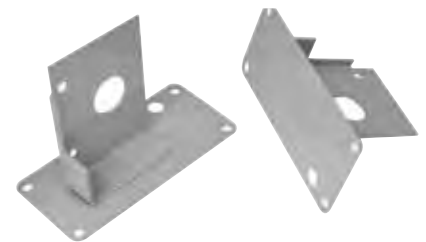

TAILGATE & LIFTGATE FASTENERS

These tailgate and liftgate fastener sets include fasteners for almost everything on the tailgate and liftgate, including the hinge screw (also sold as #2065, shown below) and latch and cable opening screws (also sold as #2052, shown below). This 126-piece set includes bolt and screw locations and uses stainless bolts where chrome was originally used.



- 1955-57 #17630..... \$26.95/set
- 1955-57 Wagon #2063..... \$27.95/set

TAILGATE SCREWS

This handy set mounts the tailgate latches to the tailgate, the striker plates to the body, and the tailgate cable openings to both the tailgate and the body. All hardware is stainless steel. Includes 24 screws and lock washers.



- 1955-57 Nomad & Wagon..... #2052..... \$15.95/set



TAILGATE FASTENERS

- 1955-57 Sedan Delivery #11308.....\$11.95/kit



TAILGATE HINGE TO BODY AND HINGE TO TAILGATE SCREWS

Enough for one hinge.
1955-57 Nomad & Wagon..... #2065..... \$6.25/set



NOMAD AND WAGON INNER TAILGATE ACCESS COVERS

- 1955-57 Polished Stainless..... #18327..... \$99.95/ea.
- 1955-57 Chrome #18383..... \$59.95/ea.



LOWER TAILGATE BUMPER BRACKET ASSEMBLY

- 1955-57 Nomad, Wagon & Sedan Del. #18320..... \$9.95/ea.

WAGON TAILGATE WEDGES WITH SPRINGS

These are the plastic wedges with the springs that install at the center of the tailgate under the chrome tailgate access cover.



- 1955-57 #14699.....\$9.95/pr.

WAGON TAILGATE WEDGE SPRINGS

- 1955-57 #18162.....\$2.50/pr.

1955-56-57 GLASS

Glass is available in clear, factory light green tinted and a 30% Gray smoked tint (10% smoked tint on the windshields). All glass orders are drop shipped directly from our supplier to you. If you are sending in a check or money order for payment please call for a freight quote before ordering. Glass marked with an (*) are date coded and require your car's VIN#.



FOR SMOKED GLASS ADD AN "S" AFTER APPLICABLE TINTED PART NUMBER. SMOKED GLASS NOT AVAILABLE WITH DATE CODE.

DATE CODED GLASS

WINDSHIELD GLASS FOR 1955-56'S

Hardtop, Conv, Nomad, Clear.....	#11048	\$209.95/ea.
HT, Conv, Nomad, Tinted.....	#11049	\$209.95/ea.
Hardtop, Conv, Nomad, Clear.....	#11050*	\$299.95/ea.
HT, Conv, Nomad, Tinted.....	#11051*	\$299.95/ea.
Sedan, Wagon, Clear.....	#11052	\$209.95/ea.
Sedan, Wagon, Tinted.....	#11053	\$209.95/ea.
Sedan, Wagon, Clear.....	#11054*	\$299.95/ea.
Sedan, Wagon, Tinted.....	#11055*	\$299.95/ea.

WINDSHIELD GLASS FOR 1957'S

Hardtop, Conv, Nomad, Clear.....	#11056	\$209.95/ea.
HT, Conv, Nomad, Tinted.....	#11057	\$209.95/ea.
Hardtop, Conv, Nomad, Clear.....	#11058*	\$299.95/ea.
HT, Conv, Nomad, Tinted.....	#11059*	\$299.95/ea.
Sedan, Wagon, Clear.....	#11060	\$209.95/ea.
Sedan, Wagon, Tinted.....	#11061	\$209.95/ea.
Sedan, Wagon, Clear.....	#11062*	\$299.95/ea.
Sedan, Wagon, Tinted.....	#11063*	\$299.95/ea.

VENT WINDOW GLASS FOR 1955-57'S

Hardtop, Conv., Nomad, Clear.....	#10940	\$29.95/ea.
HT, Conv., Nomad, Tinted.....	#10941	\$29.95/ea.
HT, Conv, Nomad, Tinted.....	#10942*	\$74.95/ea.
Hardtop, Conv, Nomad, Clear.....	#10943*	\$74.95/ea.
Sedan, Wagon, Clear.....	#10944	\$29.95/ea.
Sedan, Wagon, Tinted.....	#10945	\$29.95/ea.
Sedan, Wagon, Clear.....	#10946*	\$74.95/ea.
Sedan, Wagon, Tinted.....	#10947*	\$74.95/ea.

FRONT DOOR WINDOW GLASS 1955-57'S

2-Door Hardtop, Conv., Clear.....	#10952	\$59.95/ea.
2-Door Hardtop, Conv., Tinted.....	#10953	\$59.95/ea.
2-Door Hardtop, Conv., Clear.....	#10954*	\$97.95/ea.
2-Door Hardtop, Conv., Tinted.....	#10955*	\$97.95/ea.
Sedan, Wagon, Clear.....	#10956	\$59.95/ea.
Sedan, Wagon, Tinted.....	#10957	\$59.95/ea.
Sedan, Wagon, Clear.....	#10958*	\$97.95/ea.
Sedan, Wagon, Tinted.....	#10959*	\$97.95/ea.
Nomad, Clear.....	#10960	\$59.95/ea.
Nomad, Tinted.....	#10961	\$59.95/ea.
Nomad, Clear.....	#10962*	\$105.00/ea.
Nomad, Tinted.....	#10963*	\$105.00/ea.

FRONT DOOR WINDOW GLASS 1956-57'S

4-Door Hardtop, Clear.....	#10948	\$59.95/ea.
4-Door Hardtop, Tinted.....	#10949	\$59.95/ea.
4-Door Hardtop, Clear.....	#10950*	\$105.00/ea.
4-Door Hardtop, Tinted.....	#10951*	\$105.00/ea.

REAR DOOR WINDOW GLASS 1956-57'S

4-Door Hardtop, Clear.....	#10964	\$59.95/ea.
4-Door Hardtop, Tinted.....	#10965	\$59.95/ea.
4-Door Hardtop, Clear.....	#10966*	\$105.00/ea.
4-Door Hardtop, Tinted.....	#10967*	\$105.00/ea.
4-Door Sedan, Clear.....	#10968	\$59.95/ea.
4-Door Sedan, Tinted.....	#10969	\$59.95/ea.
4-Door Sedan, Clear.....	#10970*	\$105.00/ea.
4-Door Sedan, Tinted.....	#10971*	\$105.00/ea.
4-Door Wagon, Clear.....	#10972	\$59.95/ea.
4-Door Wagon, Tinted.....	#10973	\$59.95/ea.
4-Door Wagon, Clear.....	#10974*	\$105.00/ea.
4-Door Wagon, Tinted.....	#10975*	\$105.00/ea.

QUARTER GLASS FOR 1955-57'S

2-Door Hardtop, Clear.....	#10976	\$59.95/ea.
2-Door Hardtop, Tinted.....	#10977	\$59.95/ea.
2-Door Hardtop, Clear.....	#10978*	\$97.95/ea.
2-Door Hardtop, Tinted.....	#10979*	\$97.95/ea.
Convertible, Clear.....	#10980	\$59.95/ea.
Convertible, Tinted.....	#10981	\$59.95/ea.
Convertible, Clear.....	#10982*	\$97.95/ea.
Convertible, Tinted.....	#10983*	\$97.95/ea.
2-Door Sedan, Clear.....	#10984	\$59.95/ea.
2-Door Sedan, Tinted.....	#10985	\$59.95/ea.
2-Door Sedan, Clear.....	#10986*	\$97.95/ea.
2-Door Sedan, Tinted.....	#10987*	\$97.95/ea.
150 2-Dr Sedan, Fixed, Clear.....	#10984A	\$59.95/ea.
150 2-Dr Sedan, Fixed, Tinted.....	#10985A	\$59.95/ea.
150 2-Dr Sedan, Fixed, Clear.....	#10986A	\$97.95/ea.
150 2-Dr Sed., Fixed, Tinted.....	#10987A	\$97.95/ea.
4-Door Sedan, Clear.....	#10988	\$59.95/ea.
4-Door Sedan, Tinted.....	#10989	\$59.95/ea.
4-Door Sedan, Clear.....	#10990*	\$97.95/ea.
4-Door Sedan, Tinted.....	#10991*	\$97.95/ea.
150 2-Door Wagon, Clear.....	#10992	\$59.95/ea.
150 2-Door Wagon, Tinted.....	#10993	\$59.95/ea.
150 2-Door Wagon, Clear.....	#10994*	\$97.95/ea.
150-2 Door Wagon, Tinted.....	#10995*	\$97.95/ea.
210 2-Door Wagon, Clear.....	#10996	\$59.95/ea.
210 2-Door Wagon, Tinted.....	#10997	\$59.95/ea.
210 2-Door Wagon, Clear.....	#10998*	\$97.95/ea.
210 2-Door Wagon, Tinted.....	#10999*	\$97.95/ea.

SLIDER GLASS FOR 1955-57'S

Nomad, Clear.....	#11020	\$59.95/ea.
Nomad, Tinted.....	#11021	\$59.95/ea.
Nomad, Clear.....	#11022*	\$97.95/ea.
Nomad, Tinted.....	#11023*	\$97.95/ea.

REAR CURVED QUARTER GLASS 55-57'S

2-Dr Wagon, Clear, Right.....	#11024	\$299.95/ea.
2-Dr Wagon, Tinted, Right.....	#11025	\$299.95/ea.
2-Dr Wagon, Clear, Right.....	#11026*	\$350.00/ea.
2-Dr Wagon, Tinted, Right.....	#11027*	\$350.00/ea.
2-Dr Wagon, Clear, Left.....	#11028	\$299.95/ea.
2-Dr Wagon, Tinted, Left.....	#11029	\$299.95/ea.
2-Dr Wagon, Clear, Left.....	#11030*	\$350.00/ea.
2-Dr Wagon, Tinted, Left.....	#11031*	\$350.00/ea.
4-Dr Wagon, Clear, Right.....	#11032	\$299.95/ea.
4-Dr Wagon, Tinted, Right.....	#11033	\$299.95/ea.
4-Dr Wagon, Clear, Right.....	#11034*	\$350.00/ea.
4-Dr Wagon, Tinted, Right.....	#11035*	\$350.00/ea.
4-Dr Wagon, Clear, Left.....	#11036	\$299.95/ea.
4-Dr Wagon, Tinted, Left.....	#11037	\$299.95/ea.
4-Dr Wagon, Clear, Left.....	#11038*	\$350.00/ea.
4-Dr Wagon, Tinted, Left.....	#11039*	\$350.00/ea.
Nomad, Clear, Right.....	#11040	\$299.95/ea.
Nomad, Tinted, Right.....	#11041	\$299.95/ea.
Nomad, Clear, Right.....	#11042*	\$350.00/ea.
Nomad, Tinted, Right.....	#11043*	\$350.00/ea.
Nomad, Clear, Left.....	#11044	\$299.95/ea.
Nomad, Tinted, Left.....	#11045	\$299.95/ea.
Nomad, Clear, Left.....	#11046*	\$350.00/ea.
Nomad, Tinted, Left.....	#11047*	\$350.00/ea.

REAR WINDOW GLASS FOR 1955-57'S

2-Door Hardtop, Clear.....	#11004	\$299.95/ea.
2-Door Hardtop, Tinted.....	#11005	\$299.95/ea.
2-Door Hardtop, Clear.....	#11006*	\$395.00/ea.
2-Door Hardtop, Tinted.....	#11007*	\$395.00/ea.
Sedan, Clear.....	#11008	\$299.95/ea.
Sedan, Tinted.....	#11009	\$299.95/ea.
Sedan, Clear.....	#11010*	\$395.00/ea.
Sedan, Tinted.....	#11011*	\$395.00/ea.

REAR WINDOW GLASS FOR 1956-57'S

4-Door Hardtop, Tinted.....	#11001	\$299.95/ea.
4-Door Hardtop, Tinted.....	#11003*	\$395.00/ea.

LIFTGATE GLASS FOR 1955-57'S

Wagon, Clear.....	#11012	\$299.95/ea.
Wagon, Tinted.....	#11013	\$299.95/ea.
Wagon, Clear.....	#11014*	\$395.00/ea.
Wagon, Tinted.....	#11015*	\$395.00/ea.
Nomad, Clear.....	#11016	\$299.95/ea.
Nomad, Tinted.....	#11017	\$299.95/ea.
Nomad, Clear.....	#11018*	\$395.00/ea.
Nomad, Tinted.....	#11019*	\$395.00/ea.

GLASS SETS

Sets listed as assembled will include chrome frames and lower channels pre-installed, where applicable.

CONVERTIBLE GLASS SETS FOR 55-57'S

6-pc. Side Set, Clear.....	#11064	\$199.95/set
6-pc. Side Set, Tinted.....	#11065	\$199.95/set
6-pc. Side Set, Clear.....	#11066*	\$299.95/set
6-pc. Side Set, Tinted.....	#11067*	\$299.95/set

CONVERTIBLE GLASS SETS 1955-56'S

7-pc. Set, Clear.....	#11068	\$399.95/set
7-pc. Set, Tinted.....	#11069	\$399.95/set
7-pc. Set, Clear.....	#11070*	\$559.95/set
7-pc. Set, Tinted.....	#11071*	\$559.95/set

CONVERTIBLE GLASS SETS 1957'S

7-pc. Set, Clear.....	#11068A	\$399.95/set
7-pc. Set, Tinted.....	#11069A	\$399.95/set
7-pc. Set, Clear.....	#11070A	\$559.95/set
7-pc. Set, Tinted.....	#11071A	\$559.95/set

2-DOOR HARDTOP GLASS SETS FOR 1955-57'S

6-pc. Side Set, Clear.....	#11072	\$216.95/set
6-pc. Side Set, Tinted.....	#11073	\$219.95/set
6-pc. Side Set, Clear.....	#11074*	\$299.95/set
6-pc. Side Set, Tinted.....	#11075*	\$299.95/set

2-DOOR HARDTOP GLASS 1955-56'S

8-pc. Set, Clear.....	#11076	\$659.95/set
8-pc. Set, Tinted.....	#11077	\$649.95/set
8-pc. Set, Clear.....	#11078*	\$799.95/set
8-pc. Set, Tinted.....	#11079*	\$799.95/set

2-DOOR HARDTOP SETS FOR 1957'S

8-pc. Set, Clear.....	#11076A	\$649.95/set
8-pc. Set, Tinted.....	#11077A	\$649.95/set
8-pc. Set, Clear.....	#11078A	\$799.95/set
8-pc. Set, Tinted.....	#11079A	\$799.95/set

SIDE SETS WITH FRAMES FOR 1955-57'S

6-Piece, 2-Dr HT, Clear.....	#14885	\$899.95/ea.
6-Piece, Convertible, Clear.....	#14886	\$1049.95/ea.
6-Piece, 2-Dr HT, Tinted.....	#14887	\$899.95/ea.
6-Piece, Convertible, Tinted.....	#14888	\$1049.95/ea.
6-Piece, 2-Dr HT, Smoked.....	#14889	\$899.95/ea.
6-Piece, Convertible, Smoked.....	#14890	\$1049.95/ea.

4-DOOR HARDTOP SETS FOR 56-57'S

6-pc. Side Set, Clear.....	#11100	\$199.95/set
6-pc. Side Set, Tinted.....	#11101	\$199.95/set
6-pc. Side Set, Clear.....	#11102*	\$525.00/set
6-pc. Side Set, Tinted.....	#11103*	\$525.00/set

4-DOOR HARDTOP SETS FOR 1956'S

7-pc. Set, Clear.....	#11104	\$459.95/set
8-pc. Set, Tinted.....	#11105	\$659.95/set
7-pc. Set, Clear.....	#11106*	\$559.95/set
8-pc. Set, Tinted.....	#11107*	\$759.95/set

4-DOOR HARDTOP SETS FOR 1957'S

7-pc. Set, Clear.....	#11104A	\$459.95/set
8-pc. Set, Tinted.....	#11105A	\$659.95/set
7-pc. Set, Clear.....	#11106A	\$559.95/set
8-pc. Set, Tinted.....	#11107A	\$759.95/set

FOR SMOKED GLASS ORDERS, ADD AN "S" TO THE TINTED PART NUMBER FOR YOUR APPLICATION. SMOKED GLASS NOT AVAILABLE WITH DATE CODE.



NOMAD GLASS SETS FOR 1955-57'S 

- 4-pc. Door/Vent Set, Assembled, Clear
..... #15289 \$496.00/set
- 4-pc. Door/Vent Set, Assembled, Tinted
..... #15290 \$496.00/set
- 4-pc. Door/Vent Set, Assembled, Smoked
..... #15291 \$496.00/set
- 6-pc. Side Set, Clear..... #11080 \$219.95/set
- 6-pc. Side Set, Tinted #11081 \$219.95/set
- 6-pc. Side Set, Clear..... #11082* \$289.95/set
- 6-pc. Side Set, Tinted #11083* \$289.95/set
- 8-pc. Side Set, Clear..... #11084 \$729.95/set
- 8-pc. Side Set, Tinted #11085 \$729.95/set
- 8-pc. Side Set, Clear..... #11086* \$1095.00/set
- 8-pc. Side Set, Tinted #11087* \$1095.00/set

NOMAD GLASS SETS FOR 1955-56'S 

- 10-pc. Set, Clear #11088 \$1295.95/set
- 10-pc. Set, Tinted #11089 \$1295.95/set
- 10-pc. Set, Clear #11090* \$1395.95/set
- 10-pc. Set, Tinted #11091* \$1395.95/set

NOMAD GLASS SETS FOR 1957'S 

- 10-pc. Set, Clear #11088A..\$1295.95/set
- 10-pc. Set, Tinted #11089A...\$1295.95/set
- 10-pc. Set, Clear #11090A* ..\$1395.95/set
- 10-pc. Set, Tinted #11091A* ..\$1395.95/set

2-DOOR SEDAN GLASS SETS FOR 55-57'S 

- 6-pc. Side Set, Clear..... #11092 \$219.95/set
- 6-pc. Side Set, Tinted #11093 \$219.95/set
- 6-pc. Side Set, Clear..... #11094* \$299.95/set
- 6-pc. Side Set, Tinted #11095* \$299.95/set
- 6-pc. Side Set, Assembled, Clear..... #15283 \$479.95/set
- 6-pc. Side Set, Assembled, Tinted
..... #15284 \$479.95/set
- 6-pc. Side Set, Assembled, Smoked
..... #15285 \$479.95/set

2-DOOR SEDAN SETS FOR 1955-56'S 

- 8-pc. Set, Clear #11096 \$649.95/set
- 8-pc. Set, Tinted #11097 \$649.95/set
- 8-pc. Set, Clear #11098* \$799.95/set
- 8-pc. Set, Tinted #11099* \$799.95/set

2-DOOR SEDAN GLASS SETS 1957'S 

- 8-pc. Set, Clear #11096A \$649.95/set
- 8-pc. Set, Tinted #11097A \$649.95/set
- 8-pc. Set, Clear #11098A \$799.95/set
- 8-pc. Set, Tinted #11099A \$799.95/set

4-DOOR SEDAN GLASS SETS FOR 55-57'S 

- 8-pc. Side Set, Clear..... #11108 \$281.95/set
- 8-pc. Side Set, Tinted #11109 \$281.95/set
- 8-pc. Side Set, Clear..... #11110* \$695.00/set
- 8-pc. Side Set, Tinted #11111* \$695.00/set
- 6-pc. Side Set, Assembled, Clear
..... #15286 \$479.95/set
- 6-pc. Side Set, Assembled, Tinted
..... #15287 \$479.95/set
- 6-pc. Side Set, Assembled, Smoked
..... #15288 \$479.95/set

4-DOOR SEDAN GLASS 1955-56'S 

- 10-pc. Set, Clear #11112 \$749.95/set
- 10-pc. Set, Tinted #11113 \$749.95/set
- 10-pc. Set, Clear #11114* \$899.95/set
- 10-pc. Set, Tinted #11115* \$899.95/set

4-DOOR SEDAN GLASS FOR 1957'S 

- 10-pc. Set, Clear #11112A \$749.95/set
- 10-pc. Set, Tinted #11113A \$749.95/set
- 10-pc. Set, Clear #11114A \$899.95/set
- 10-pc. Set, Tinted #11115A \$899.95/set

SEDAN AND WAGON DOOR GLASS WITH VENT DELETE

We now offer glass for those who have removed their vent windows. Please specify bodystyle when ordering.

- 1955-57 Clear..... #17177 \$83.95/ea.
- 1955-57 Tinted #17178 \$83.95/ea.
- 1955-57 Smoked..... #17179 \$83.95/ea.

FOR SMOKED GLASS ORDERS, ADD AN "S" TO THE TINTED PART NUMBER FOR YOUR APPLICATION. SMOKED GLASS NOT AVAILABLE WITH DATE CODE.

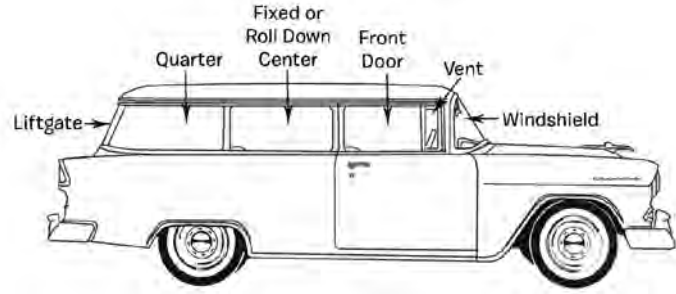
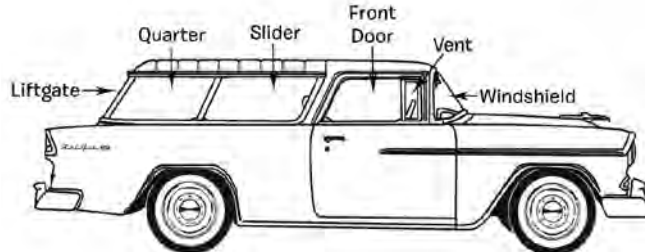
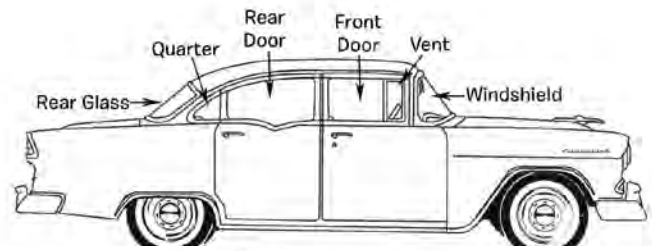
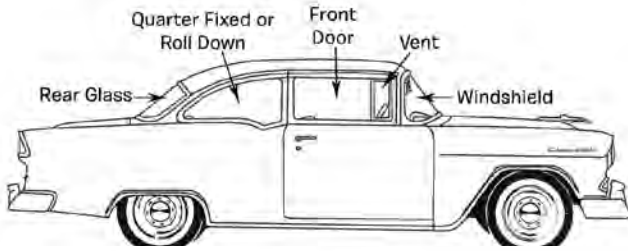

150 WAGON GLASS SETS

The center glass window on 150 wagons is either a stationary glass piece or one that rolls down. Please specify which type you need when placing your order.

150 2-DOOR WAGON SETS FOR 1955-57'S ^{O/S}

6-pc. Side Set, Clear.....	#11116.....	\$219.95/set
6-pc. Side Set, Tinted.....	#11117.....	\$219.95/set
6-pc. Side Set, Clear.....	#11118*.....	\$525.00/set
6-pc. Side Set, Tinted.....	#11119*.....	\$525.00/set
8-pc. Side Set, Clear.....	#11124.....	\$729.95/set
8-pc. Side Set, Tinted.....	#11125.....	\$729.95/set
8-pc. Side Set, Clear.....	#11126*.....	\$1100.00/set
8-pc. Side Set, Tinted.....	#11127*.....	\$1100.00/set

150 2-DOOR WAGON GLASS 1955-56'S ^{1/2}

10-pc. Set, Clear.....	#11132.....	\$1159.95/set
10-pc. Set, Tinted.....	#11133.....	\$1159.95/set
10-pc. Set, Clear.....	#11134*.....	\$1395.95/set
10-pc. Set, Tinted.....	#11135*.....	\$1395.95/set

150 2-DOOR WAGON GLASS FOR 1957'S ^{1/2}

10-pc. Set, Clear.....	#11132A.....	\$1159.95/set
10-pc. Set, Tinted.....	#11133A.....	\$1159.95/set
10-pc. Set, Clear.....	#11134A.....	\$1395.95/set
10-pc. Set, Tinted.....	#11135A.....	\$1395.95/set

SEDAN DELIVERY GLASS FOR 1955-57'S ^{O/S}

4-pc. Side Set, Clear.....	#11152.....	\$154.95/set
4-pc. Side Set, Tinted.....	#11153.....	\$154.95/set
4-pc. Side Set, Clear.....	#11154*.....	\$340.00/set
4-pc. Side Set, Tinted.....	#11155*.....	\$340.00/set

SEDAN DELIVERY GLASS 1955-56'S ^{1/2}

6-pc. Set, Clear.....	#11156.....	\$599.95/set
6-pc. Set, Tinted.....	#11157.....	\$599.95/set
6-pc. Set, Clear.....	#11158*.....	\$774.95/set
6-pc. Set, Tinted.....	#11159*.....	\$774.95/set

SEDAN DELIVERY GLASS FOR 1957'S ^{1/2}

6-pc. Set, Clear.....	#11156A.....	\$599.95/set
6-pc. Set, Tinted.....	#11157A.....	\$599.95/set
6-pc. Set, Clear.....	#11158A.....	\$774.95/set
6-pc. Set, Tinted.....	#11159A.....	\$774.95/set

210 2-DOOR WAGON GLASS FOR 55-57'S ^{O/S}

6-pc. Side Set, Clear.....	#11120.....	\$219.95/set
6-pc. Side Set, Tinted.....	#11121.....	\$219.95/set
6-pc. Side Set, Clear.....	#11122*.....	\$525.00/set
6-pc. Side Set, Tinted.....	#11123*.....	\$525.00/set
8-pc. Side Set, Clear.....	#11128.....	\$729.95/set
8-pc. Side Set, Tinted.....	#11129.....	\$729.95/set
8-pc. Side Set, Clear.....	#11130*.....	\$1100.00/set
8-pc. Side Set, Tinted.....	#11131*.....	\$1100.00/set

210 2-DOOR WAGON GLASS 1955-56'S ^{1/2}

10-pc. Set, Clear.....	#11136.....	\$1159.95/set
10-pc. Set, Tinted.....	#11137.....	\$1159.95/set
10-pc. Set, Clear.....	#11138*.....	\$1259.95/set
10-pc. Set, Tinted.....	#11139*.....	\$1259.95/set

210 2-DOOR WAGON GLASS 1957'S ^{1/2}

10-pc. Set, Clear.....	#11136A.....	\$1159.95/set
10-pc. Set, Tinted.....	#11137A.....	\$1159.95/set
10-pc. Set, Clear.....	#11138A.....	\$1259.95/set
10-pc. Set, Tinted.....	#11139A.....	\$1259.95/set

4-DOOR WAGON GLASS FOR 1955-57'S ^{O/S}

6-pc. Side Set, Clear.....	#11140.....	\$219.95/set
6-pc. Side Set, Tinted.....	#11141.....	\$219.95/set
6-pc. Side Set, Clear.....	#11142*.....	\$525.00/set
6-pc. Side Set, Tinted.....	#11143*.....	\$525.00/set
8-pc. Side Set, Clear.....	#11144.....	\$729.95/set
8-pc. Side Set, Tinted.....	#11145.....	\$729.95/set
8-pc. Side Set, Clear.....	#11146*.....	\$1100.00/set
8-pc. Side Set, Tinted.....	#11147*.....	\$1100.00/set

4-DOOR WAGON GLASS 1955-56'S ^{1/2}

10-pc. Set, Clear.....	#11148.....	\$1295.95/set
10-pc. Set, Tinted.....	#11149.....	\$1295.95/set
10-pc. Set, Clear.....	#11150*.....	\$1395.95/set
10-pc. Set, Tinted.....	#11151*.....	\$1395.95/set

4-DOOR WAGON GLASS FOR 1957'S ^{1/2}

10-pc. Set, Clear.....	#11148A.....	\$1295.95/set
10-pc. Set, Tinted.....	#11149A.....	\$1295.95/set
10-pc. Set, Clear.....	#11150A.....	\$1395.95/set
10-pc. Set, Tinted.....	#11151A.....	\$1395.95/set

FOR SMOKED GLASS ORDERS, ADD AN "S" TO THE TINTED PART NUMBER FOR YOUR APPLICATION. SMOKED GLASS NOT AVAILABLE WITH DATE CODE.

14. Literature

SECTION AT A GLANCE:

Manuals.....	660
Books.....	665
Decals.....	672



COLOR ACCESSORY BOOKLETS

Each booklet fully documents the accessories available for each model year. Included are some items so rare they are almost non-existent today.

- 1955..... #501..... \$11.95/ea.
- 1956..... #502..... \$11.95/ea.
- 1957..... #503..... \$11.95/ea.



1955-56-57 COLORING BOOK AND I.D. MANUAL

All..... #16998.... \$5.95/ea.



CHEVROLET FACTORY ASSEMBLY MANUALS

These bound books are reprints of the manuals used on the assembly line at General Motors and are essential for correct car restoration. Each manual contains detailed assembly drawings, original part numbers, and more. You can save yourself much time and frustration by understanding the complete assembly before you begin a project.

- 1955..... #506..... \$21.95/ea.
- 1956..... #507..... \$21.95/ea.
- 1957..... #508..... \$21.95/ea.



ACCESSORY INSTALLATION MANUALS

These are reprints of the Chevrolet originals used by dealers to install the wide variety of accessories available. 1957 manual includes truck applications.

- 1955..... #504..... \$14.95/ea.
- 1956..... #16658.. \$13.95/ea.
- 1957..... #505..... \$16.95/ea.

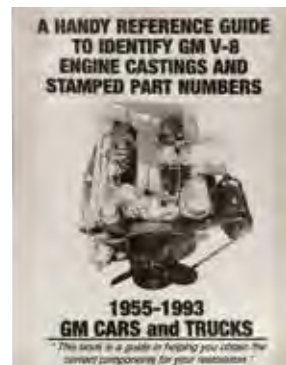

GM CASTING & STAMPED PART NUMBER REFERENCE

Originally published by Chevrolet in 1993, this catalog of Chevy V8 engine casting and stamped numbers was designed as a guide to help restorers get the proper parts for their restorations. It is full of valuable information like part numbers, CID, years, model applications, comments and more.

All..... #18534.. \$19.95/ea.

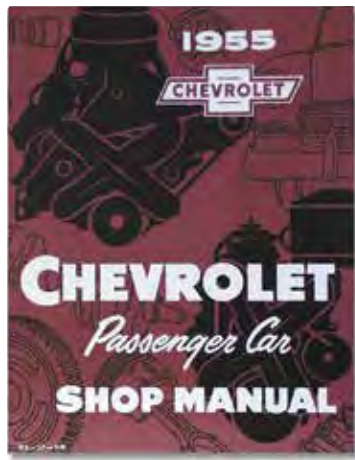

1955 CHEVROLET SHOP MANUAL
 Contains over 500 pages devoted to the 1955 model year. This authorized reprint of a GM manual documents every mechanical operation involved in the care and maintenance of the 1955 Chevy. Used exclusively by mechanics in the Chevrolet garages since the car first hit the streets.
1955..... #522..... \$19.95/ea.



1956 SHOP SUPPLEMENT
 Supplement to the 1955 manual, this book covers only the changes made for 1956, with a section devoted exclusively to factory air conditioning. '56 owners will need both the '55 and '56 manuals for complete information. This is an authorized reprint of the GM original used exclusively by mechanics in the Chevrolet garages.
1956..... #523..... \$13.95/ea.



1957 CHEVROLET SHOP MANUAL
 Filling over 700 pages with detailed information, this book is a must for 1957 owners. This comprehensive manual covers all engines, transmissions, and body styles for the 1957 model year. It's an authorized reprint of the GM original used exclusively by mechanics in Chevrolet dealerships and repair shops.
1957..... #524..... \$28.95/ea.



1958 CHEVROLET SHOP MANUAL
 An authorized reprint of the GM original used exclusively by mechanics in Chevrolet dealerships and repair shops.
1958..... #525..... \$24.95/ea.



1959-60 CHEVROLET SHOP MANUAL/SUPPLEMENT
 This manual is a supplement to the 1958 manual, #525. It only covers the changes made in 1959 and 1960. 1959-1960 owners will require both the 1958 and 1959-1960 manuals for complete information. This is an authorized reprint of the GM original used exclusively by mechanics in Chevrolet dealerships and repair shops.
1959-60 #526..... \$19.95/ea.



CHEVROLET OWNER'S MANUALS
 These 2-color heavy stock reprints contain information needed to safely operate, care for, and maintain your automobile.
1955..... #519..... \$13.95/ea.
1956..... #520..... \$13.95/ea.
1957..... #521..... \$13.95/ea.

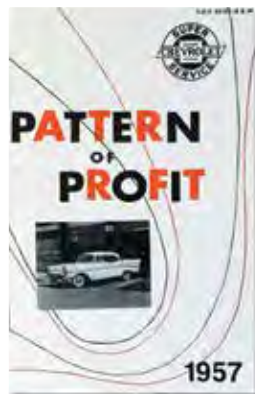

1957 PATTERN OF PROFIT MANUAL

Published by GM Corporation in 1957, this manual is a complete review of a slideshow presentation created for Chevrolet service departments. Pattern of Profit instructed service departments on the correct way to do a "quality conditioning job" quickly and efficiently. A true collector's item for the '57 Chevy buff.

1957..... #2764.... \$13.95/ea.



AIR CONDITIONING SHOP MANUAL

An authorized reprint of the GM original used exclusively by mechanics in Chevrolet repair shops. This manual is designed to provide complete information on the operation, construction, and maintenance of the Chevrolet All-Weather Air Conditioning System.

1955-57 #2763..... \$9.95/ea.

SERVICING THE CHEVROLET SPHERICAL JOINT MANUAL

Published in February of 1955, this manual covers the rebuilding and aligning of the spherical (ball) joint front suspension on the new Chevrolet cars.

1955-57 #17629.... \$9.95/ea.



COLOR SALES BROCHURES

Handed out at car dealerships, these color booklets helped the customer to pick and choose the models, colors, and fabrics available. Sorry, the brochures for the Sedan Delivery models are not available.

1955 (Shown)	#511	\$8.95/ea.
1955 Nomad & Wagon.....	#511A	\$8.95/ea.
1956 (Shown)	#512	\$8.95/ea.
1956 Nomad & Wagon.....	#512A	\$8.95/ea.
1957 (Shown)	#513	\$8.95/ea.
1957 Nomad & Wagon.....	#513A	\$8.95/ea.



CONVERTIBLE OWNER'S BOOKLETS

These 16-page color booklets describe in detail the operation, care, and maintenance of your convertible top. Exactly like the original, and a must-have for collectors.

1955.....	#514	\$8.95/ea.
1956.....	#515	\$8.95/ea.
1957.....	#516	\$8.95/ea.



1955 AIR CONDITIONING MAINTENANCE BOOKS

Use this set of authorized reprints to stay on top of your air conditioning system. The theory and operation book contains illustrations and diagrams that explain how the system works, and the maintenance book has large step-by-step photos that show you how to keep it all in order.

1955..... #1502.....\$16.95/set



DELCO-REMY 12 VOLT ELECTRICAL EQUIPMENT SERVICE MANUAL

This manual covers the 12v electrical equipment for 1955-1957 passenger cars. It covers general troubleshooting of the charging circuit, starting circuit, ignition circuit and miscellaneous electrical.

1955-57 #16952.. \$13.95/ea.



CHEVROLET BODY MOULDINGS AND ATTACHING PARTS

This catalog has been compiled as a quick and easy reference when ordering clips and mouldings.

1953-63 #1119.... \$14.95/ea.

BODY AND CONVERTIBLE TOP ADJUSTMENTS GUIDE

This wonderful little book contains all the information necessary to eliminate the confusion of what to torque, shim and/or adjust to get the lines exact for your doors, windows, trunk lid and convertible top. A real must have for the quality restorer.

1955-57 #13292.. \$14.95/ea.



SUGGESTED DELIVERED PRICES

Chevrolet dealerships used the Suggested Delivered Prices booklets as guides for setting their retail prices. Suggested prices for factory installed options and accessories are also included. This is another interesting addition to any '55-56-57 enthusiast's collection. The 1955 booklet covers trucks and commercial vehicles as well.

1955..... #1829..... \$4.95/ea.
1957..... #1830..... \$3.95/ea.



ROCHESTER FUEL INJECTION MANUAL

General Motors' Rochester Products Division produced this very informative manual to cover the fuel injection systems produced between 1957 and 1962. 1957 owners will find this manual covers many of the same points the Chevrolet Fuel Injection shop manual (shown below) does, but with even more detailed technical information. Photographs depict the 1962 "flat top" design, but in function the units are identical. Every 1957 F.I. owner should have a copy of this valuable book.

1957-62 #1775 \$10.95/ea.

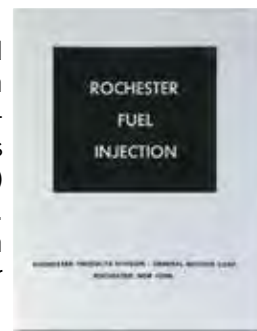

1957 CHEVROLET FUEL INJECTION SHOP MANUAL

With this manual the Chevrolet service man was provided with complete information on construction, operation, maintenance, and repair of the fuel injection system. Plenty of illustrations and photographs detail the step-by-step operations necessary to keep the system working properly. A great collector's item, and best when used with the Rochester Fuel Injection Manual, shown above.

1957..... #1776 \$12.95/ea.



BODY BY FISHER SERVICE NEWS

Published by the Fisher Body Service Division of General Motors, these interesting manuals contain loads of detailed information on the 1955 and 1956 Chevrolet car bodies.

1955 Vol. 1 (Shown) #992 \$9.95/ea.

1955 Vol. 2..... #1115 \$6.95/ea.

1955 Wagon, Sed. Del. #1116 \$9.95/ea.

1956..... #1118 \$6.95/ea.

1956 4-Dr Sport Sedan #1117 \$9.95/ea.



1957 CHEVROLET STOCK CAR COMPETITION GUIDE

This unique manual documents everything Chevrolet did to produce the legendary Black Widow. Fully illustrated, this book is a must for those racing the '57, and a true collector's item. When was the last time an automobile manufacturer stood so firmly behind stock car racing? This step-by-step guide tells all the Chevy secrets.

1957..... #902 \$9.95/ea.

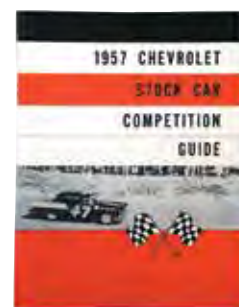

ELECTRIC WINDSHIELD WIPER SERVICE BOOKLET

Do you have a factory original electric wiper motor that needs attention, then this is the booklet for you. Covers all you need to service your electric wiper motor properly. Includes lots of images and easy to read instructions. 35 pages.

1955-57 #16541 \$13.95/ea.





#15570



#15571



#15572



#15574



#15575



#15576



#15578



#15579



#15577



#15580



#15581

PASSENGER CAR WIRING DIAGRAMS

For those who just need a wiring diagram, this is it. Covers the complete chassis, power windows/seats, bulb specs, light switch etc. For 55 A/C info see the 1956 version.

- 1955..... #15570..... \$6.95/ea.
- 1956..... #15571 \$6.95/ea.
- 1957..... #15572..... \$6.95/ea.

1956 ROCHESTER MANUAL

Volume 28, Number 4 Service news covers in detail the new Rochester 4bbl carburetor and goes over adjusting and overhaul of this power pack item.

- 1956..... #15574 \$6.95/ea.

1956 ELECTRIC WIPER MOTOR SERVICE NEWS MANUAL

Volume 28, Number 5 Service News covers in detail the electric wiper motor and also touches on transmission leak detection and more.

- 1956..... #15575 \$8.95/ea.

1957 POSITRACTION SERVICE NEWS MANUAL

Volume 29 Number 1 Service News covers the factory positraction rear axle assembly and also goes over fuel injection starting procedures and steering gear lubricant.

- 1957..... #15576..... \$8.95/ea.

1957 PRE-SEASON A/C CHECK LITERATURE

This 8 page Service News covers items such as Pre-Season A/C check, turbo-glide fluid levels and updates, electric wiper replacement and more.

- 1957 Volume 29, #3..... #15577..... \$3.95/ea.

TURBO-FIRE V8 TUNE-UP MANUAL

This 39 page booklet covers tune-up info on Chevy's new V8.

- 1955-56 #15579..... \$13.95/ea.

1956 SERVICING AIR CONDITIONING SYSTEMS MANUAL

This 38 page manual covers repair and maintenance of the factory air conditioning systems.

The info in this book may also be applied to the 1955 A/C system.

- 1956 #15578..... \$8.95/ea.

1957 TRANSMISSION SERVICE NEWS MANUAL

This 12 page "Service News" trouble-shoots Chevrolets 4-speed transmission and also covers major service, removal, disassembly/assembly and installation.

- 1957 Passenger Car & Vette 4-Speed #15580..... \$6.95/ea.

1957 CHEVY FEATURES SERVICE NEWS

Released in October of '56 this 24 page "Service News" touches on some of the new features and service bulletins of the 1957's.

- 1957 #15581 \$8.95/ea.



PHOTO COURTESY OF GERTMAN2000



“HOW TO RESTORE” BOOK
1955-56 #16657.. \$29.95/ea.

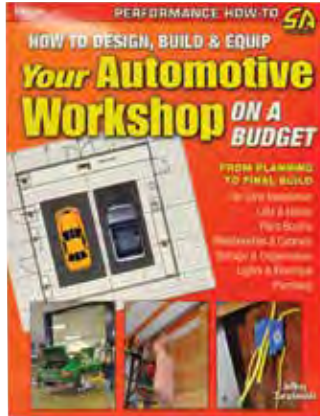

HOW TO DESIGN, BUILD & EQUIP YOUR AUTOMOTIVE WORKSHOP

How to Design, Build and Equip Your Automotive Workshop on a Budget provides the necessary information as the hobbyist considers various tools, designs, installations, and products available for their automotive workspace. Many of the ideas presented for workbenches and storage can be implemented at low cost, or even for free if you're extra resourceful.

All..... #16840.. \$24.95/ea.



AUTOMOTIVE UPHOLSTERY & INTERIOR RESTORATION BOOK

All..... #18979. \$29.95/ea..

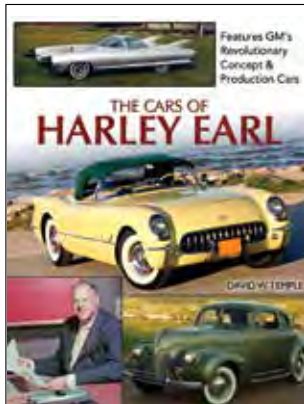

CARS OF HARLEY EARL BOOK

Harley Earl's drive toward bold and innovative design spurred American car design during the mid-twentieth century. His distinctive designs defined the 1950s finned cars and set American automotive design on the path it has followed into the modern era. With this in-depth examination, you learn the inside story of these remarkable cars and the man behind them. 192 pages, hardback.

All..... #18844.. \$39.95/ea.

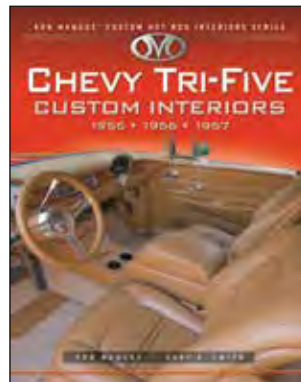

TRI-FIVE CUSTOM INTERIORS BOOKS

Award-winning cars and interiors will inspire you with design possibilities for your own 1955-1957 Chevy hot rod. You will learn the concepts behind a great interior. Large full-color photos and detailed explanations show and explain how Ron Mangus executes these design ideas. Get a detailed look at creative solutions for seats, door, kick, and rear quarter panels, carpet, mats, headliner, trunk, seat bolsters, and many other interior design areas. From the stock look to wild customs, you'll find a wide range of new ideas to adapt to your own car's interior.

All..... #18845.. \$27.95/ea.

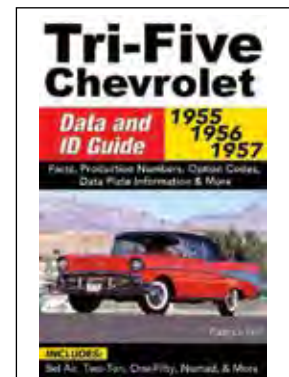

TRI-FIVE CHEVROLET DATA & ID GUIDE

All..... #19171.. \$21.95/ea.



“CHEVROLETS OF THE 50'S” BOOK

All..... #19056.. \$36.95/ea.



MOTORAMA: GM'S LEGENDARY SHOW & CONCEPT CARS

This book features fascinating period photography of Motorama cars at the show, in development, and at different locales. No other automotive show rivaled the Motorama for stunning productions and awe-inspiring cars, which makes this a must-have book. 208 pages, hardback.

All..... #18846.. \$39.95/ea.

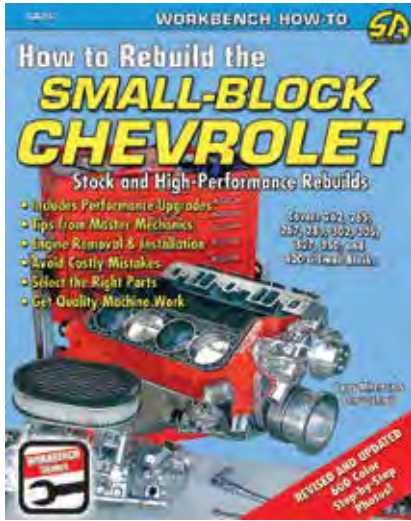

HOW TO REBUILD THE SMALL BLOCK CHEVY

How to Rebuild the Small Block Chevy is a step-by-step book that shows you how to build a street or racing small block in your own garage. Hundreds of photos and easy to read text explain every procedure a pro goes through to assemble an engine from crankshaft to carb. It covers teardown, inspection, replacement parts, machine work and much much more. 144 pages.

All..... #15756.. \$23.95/ea.



HOW TO REBUILD LS-SERIES ENGINES

This is the first book of it's kind that was written to help you rebuild your LS-Series engine. It explains the variations between the different LS-Series engines. This book has more than 600 photos, charts and illustrations to give simple instructions on disassembly thru final assembly and provides instruction for both stock and performance rebuilds. 152 pages.

All..... #15754.. \$29.95/ea.

HOW TO BUILD MAX- PERFORMANCE CHEVY SMALL BLOCK ON A BUDGET

This book shows you how to extract serious horsepower from a small block Chevy, and how to do it on a budget. Included are details of the most desired factory part numbers, easy do-it-yourself cylinder head modifications and inexpensive, but effective, aftermarket parts, blocks, best rotating assemblies, camshaft selections, ignition, induction, exhaust systems and more. It also contains the latest engine-building techniques, profiles current technology and includes today's affordable parts and engines. 160 pages.

All..... #15757.. \$28.95/ea.



REBUILDING THE SB CHEVY: STEP-BY-STEP VIDEOBOOK

This book and DVD combo is perfect for any small block Chevy enthusiast. Over 600 photos and easy to read text explains every procedure a professional engine builder uses to assemble an engine from crankshaft to carburetor. The DVD includes over two hours of coverage showing, in detail, what was covered in the book. The DVD has detailed sections showing how to disassemble a used engine, inspect for damage, select replacement parts, check critical fit and much much more. The DVD also includes a trip to the machine shop and shows you the entire process of machining an engine from start to finish. 160 pages.

All..... #15874..... \$39.95/ea.

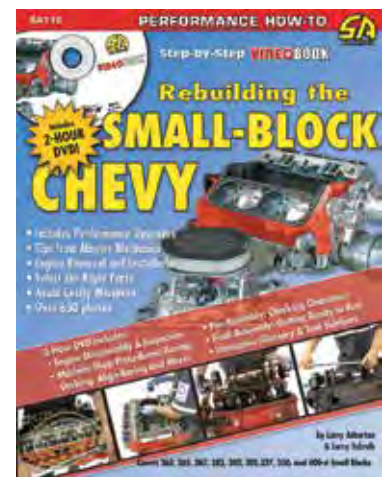

HOW TO SUPER & TURBOCHARGE LS ENGINES BOOK

This is the only book on the market specifically dedicated to forced air induction for LS-series engines. Exceptional guidance on the wide range of systems and kits available.

All..... #19450.. \$29.95/ea.

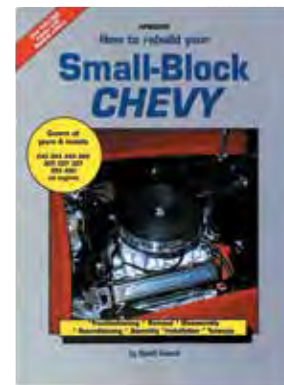

HOW-TO REBUILD YOUR SMALL-BLOCK CHEVY

This books' simple, easy to understand instructions will show you how to remove the engine, strip it down, recondition the parts, rebuild it, and replace it in the chassis. Covers all years and models.

All..... #1867.... \$22.95/ea.

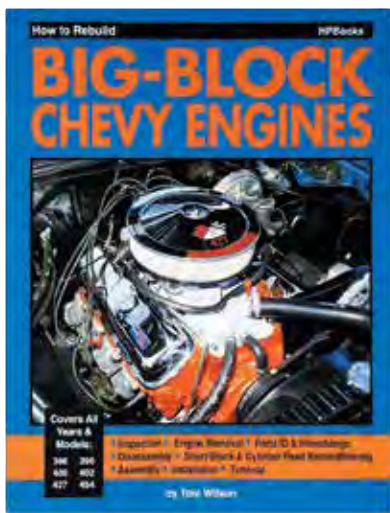

HOW-TO REBUILD YOUR BIG BLOCK CHEVY

From a simple parts swap to a complete overhaul, this handbook is the information source. Parts identification, reconditioning, and interchange, as well as engine assembly and troubleshooting, are thoroughly detailed. Reference material for all Chevy big-blocks produced from 1965 to present is included.

All..... #1868.... \$21.95/ea.

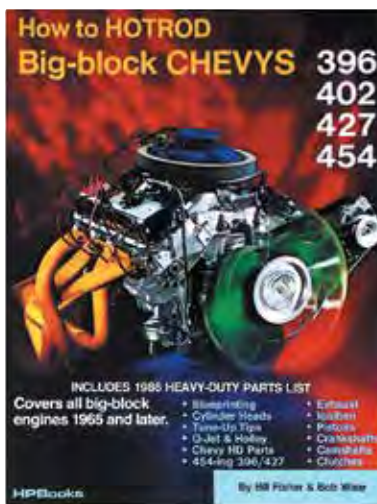

HOW-TO HOT ROD BIG BLOCK CHEVYS

Any 396, 402, 427, or 454 cu. in. engine owner can achieve outstanding acceleration and incredible speed by applying the secrets contained in this book. Everything is covered: manifolds, headers, valves, pistons and more. Material covering all big-block Chevy engines produced from 1965 to present is included.

All..... #1870.... \$21.95/ea.



TURBO HYDRA-MATIC 350

Here's a book that fills in the details that the factory manuals leave out. Now you can successfully do it yourself. Learn how to maintain, troubleshoot, dismantle, recondition, assemble, and install one of the most popular automatic transmissions ever produced.

All..... #1871.... \$21.95/ea.

HOW TO SWAP GM LS- SERIES ENGINE INTO ALMOST ANYTHING

This book is the definitive guide on how to swap an LS-Series engine into popular GM F-Body cars, such as the Camaro or Firebird as well as installing them into non-GM muscle cars, sports cars, trucks and hot rods. It includes an historical review, complete specs and detailed information so you can select and fit the best LS engine for a particular vehicle and application. There is a section on mounting kits explaining how to install these engines using readily available motor mount kits, universal mounts or fabricated mounts as well as information on necessary oil-pan modification and adapt accessory drivers as well as the best fuel pumps, exhaust systems, wiring harnesses and electronic control modules to use. The book also covers which transmissions are compatible with the LS-Series engines. 144 pages.

All..... #15751 .. \$25.95/ea.

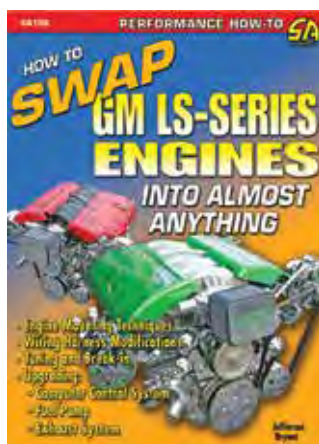

CHEVY BIG BLOCK BOOK

All..... #18000.. \$24.95/ea.



CHEVROLET INLINE SIX-CYLINDER POWER MANUAL

All..... #19172.. \$26.95/ea.

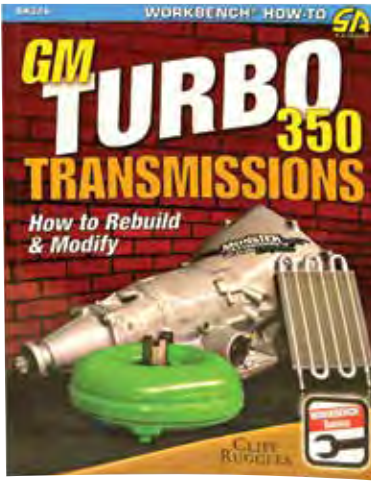

GM TURBO 350 TRANSMISSIONS - HOW TO REBUILD AND MODIFY

In GM Turbo 350 Transmissions: How to Rebuild & Modify, respected automotive technical author Cliff Ruggles guides you through the complex rebuild procedure of GM's popular rear-wheel-drive automatic transmission. With his proven style, Ruggles goes through the step-by-step rebuild and performance upgrade procedures in a series of full-color photos. He includes instruction on removal and installation, tear-down procedures, parts inspection and replacement, as well as performance mods and shift kit installation. Time-saving tips are part of every buildup as well.

All..... #18170.. \$26.95/ea.

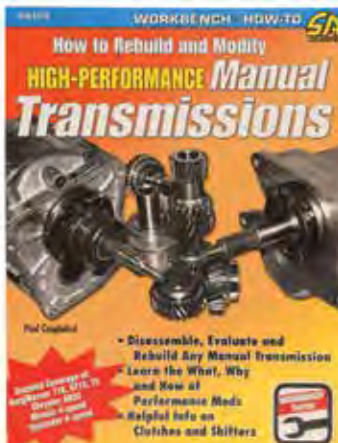

HOW TO REBUILD & MODIFY HIGH-PERFORMANCE MANUAL TRANSMISSION BOOK

All..... #18980.. \$26.95/ea.

HOW TO BUILD AND MODIFY HI-PERFORMANCE MANUAL TRANS BOOK

This book focuses on the manual transmissions that were standard fare with racers and in all the most powerful performance muscle cars of the day. It covers the T-10, Super T-10, GM/Muncie, Ford Toploader, Chrysler A833 and the new Tremec T-5. Hundreds of step-by-step photos guide you through the rebuilding processes as well as performance modifications you can make to ensure your transmission can handle all the power of your high-performance engine. The book also covers peripheral systems like clutches, pressure plates, speedometers, assemblies, shifters and shifter modifications.

Also included are tables, speedometer ratios for GM cars, torque specs, oil capacities and ratio charts for all the popular transmissions. 128 pages.

All..... #15753 .. \$29.95/ea.



GM AUTO OVERDRIVE TRANS BUILDERS/SWAPPERS GUIDE BOOK

This book will explain the history of the GM 700-R4 and 4L60 automatic transmissions. It will provide you the information necessary to identify which transmission you have and will guide you through the disassembly, repair, upgrade and assembly processes including bench testing your transmission to assure proper operation in the vehicle. Covered are high-performance modifications from the factory and aftermarket that include internal parts and external components such as shift kits and torque convertors. There is also a special section devoted to swapping these transmissions into earlier performance and muscular chassis. 128 pages.

All..... #15752 .. \$25.95/ea.

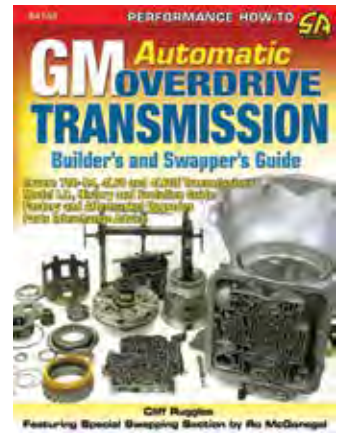

HIGH-PERFORMANCE COOLING SYSTEMS BOOK

Muscle cars and hot rod engines today are pushed to the limit with stroker kits and power adders straining the capabilities of your cooling system to extremes never seen before. Whether you are a fan of modern performance cars or a fan of more modern performance in vintage cars, this book will help you build a robust cooling system to complement your engine.

All..... #19449.....\$29.95/ea.



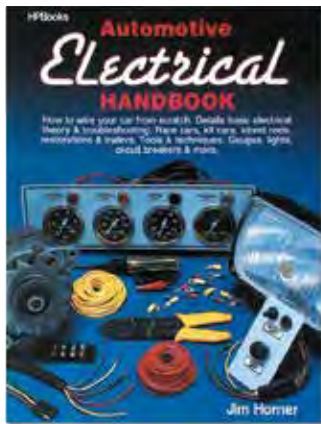

AUTOMOTIVE ELECTRICAL HANDBOOK

Step-by-step explanations of electrical theory and how components work, combined with a detailed glossary of terms and symbols, makes this book the number one reference source for your automotive wiring needs. It covers everything from the basics to how to lay out circuit diagrams.

All..... #1861.... \$21.95/ea.

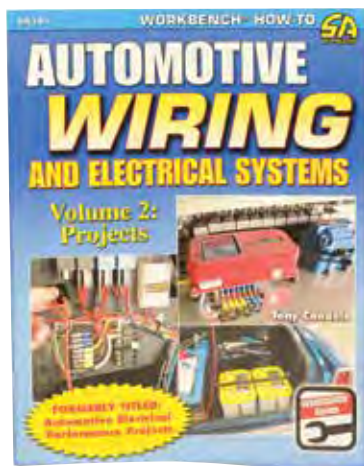

AUTOMOTIVE WIRING & ELECTRICAL SYSTEMS VOLUME 2

Countless collector car owners are skilled at performing mechanical work, but for many of them, electrical work seems like a mystery, too complicated and too confusing. However, electrical upgrades are absolutely essential for a high-performance classic car or a modified car to perform at its best. With a firm understanding of the fundamentals, you can take this comprehensive guide and complete a wide range of electrical projects that enhance the performance and functionality of a vehicle.

All..... #18169.. \$26.95/ea.

AUTOMOTIVE WIRING AND ELECTRICAL SYSTEMS

The basics of electrical principles including voltage, amperage, and Ohm's Law are revealed in clear and concise detail so the enthusiast understands what these mean in the construction and repair of automotive electrical circuits. All the tools and proper equipment required for automotive electrical tasks are covered. Also this in-depth guide explains how to perform more complex tasks such as adding new circuits, installing aftermarket electronics, repairing existing circuits building your own wiring harnesses and troubleshooting. 144 pages.

All..... #15764 .. \$24.95/ea.

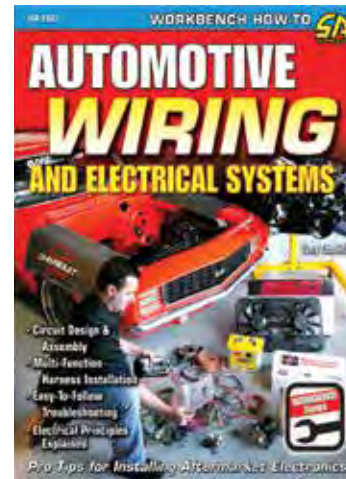

PERFORMANCE AND CUSTOM CAR WIRING & ELECTRICAL BOOK

This is the perfect guide to high performance and OEM automotive electrical systems. It covers electrical theory, techniques and equipment, custom wiring harnesses for racing, hot rods and restorations. It also covers pre-made wiring harnesses, special electrical systems (navigational, audio, video) the troubleshooting of common electrical problems, dash and instrument wiring and trailer wiring. 192 pages.

All..... #15676 \$18.95/ea.

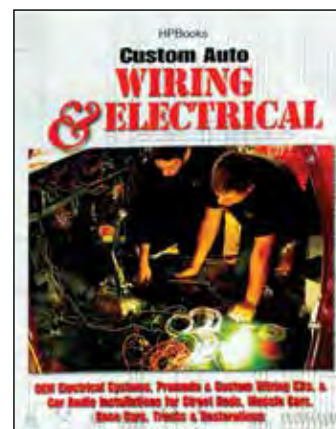

CHEVY DIFFERENTIALS HOW TO REBUILD THE 10 AND 12-BOLT

This is the only book dedicated solely to rebuilding, setting up, and modifying these axle assemblies for long service life and maximum performance. If you're going to rebuild a Chevy 10- or 12-bolt axle, this book delivers the essential information to get the job done right.

All..... #18168..... \$26.95/ea.

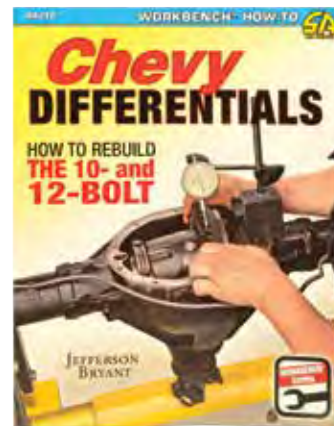

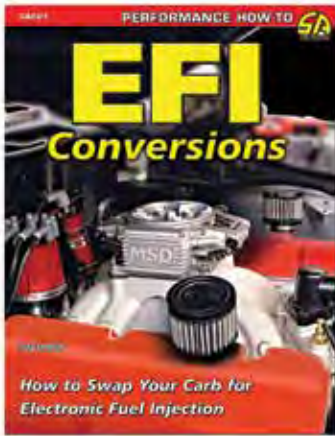

EFI CONVERSION BOOK

All..... #18001.. \$26.95/ea.

**HOLLEY CARBURETORS:
HOW TO REBUILD**

Holley carburetor owners need a rebuilding guide for understanding, disassembling, selecting parts, and reassembling their carbs, so the carb then delivers exceptional acceleration, quick response, and superior fuel economy. With Holley Carburetors: How to Rebuild you can get the carb set up and performing at its best. And, if desired, you can move to advanced levels of tuning and modifying these carbs. If you're looking for the one complete book that helps you quickly and expertly rebuild your Holley and get back on the road, this book is a vital addition to your performance library. 144 pages.

All..... #18848..... \$26.95

**ROCHESTER
CARBURETORS**

From the sophisticated Rochester electronic and computer command controlled (CCC) carburetors to the most basic model, this book will teach you what you need to know. Clear, concise text provides details on design, modification, rebuilding, and tuning. Many models are covered including the 1955-57 2G and 4G. The E2ME, E2MC, E4ME, and E4MC models, as well as the Quadrajets, are all fully explained in this detailed book.

All..... #1873.... \$22.95/ea.

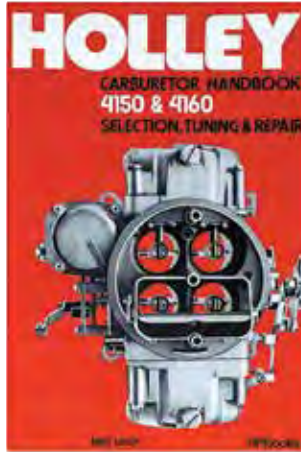

**HOLLEY 4150 AND
4160 CARBURETORS**

This is the definitive guide for 4150 and 4160 Holley carbs. You'll find plenty of detailed information on tuning, repairing, and more.

All..... #1874.... \$16.50/ea.

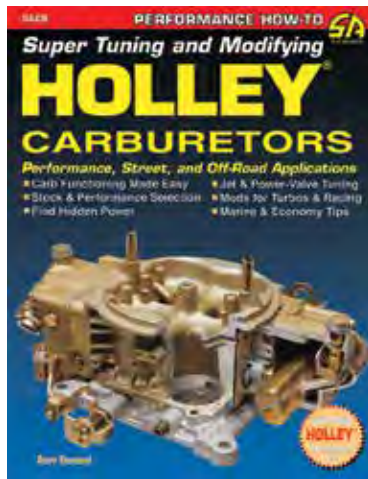

**SUPER TUNING &
MODIFYING HOLLY CARBS**

This book shows you how to select, install, tune, and modify all popular Holley performance carburetors. It gives the reader a detailed view of basic carburetor functioning, modifying for performance applications, custom tuning for the street, racing, off road, turbocharging, economy and other special uses. 144 pages.

All..... #15873.. \$24.95/ea.



SHEET METAL HANDBOOK

Sheet metal: if you want to shape it, shear it, roll it, or form it, this is the book for you. Detailed instructions cover terms, tools, equipment, layout, design, pattern making, hammer forming, and riveting techniques. This is the perfect companion to the Metal Fabricator's Handbook.

All..... #1864.... \$20.95/ea.

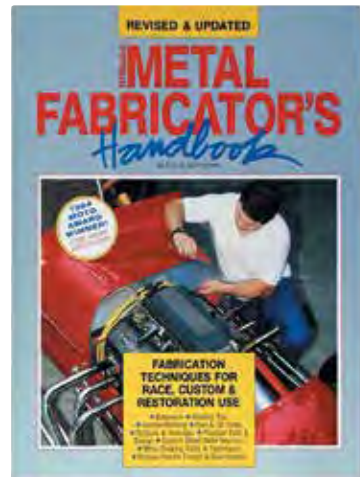

METAL FABRICATOR'S HANDBOOK

Complete instructions illustrate proper welding, metal stripping, and design techniques. With over 350 step-by-step photos as your guide, you'll learn to build structurally sound, good looking metal parts for your restoration. For other helpful references see the Sheet Metal Handbook and the Welder's Handbook.

All..... #1863.... \$21.95/ea.

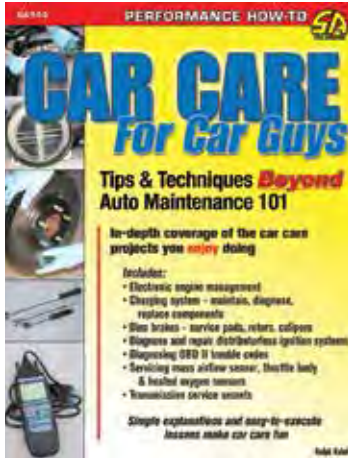

CAR CARE FOR CAR GUYS

There are plenty of guides for people who are working on their cars out of necessity. But this is not one of them. This book is written for the person that works on their cars because they WANT to. Because they enjoy it. Car Care for Car Guys gives you the critical car knowledge and advice that true gearheads possess, but that could take years to acquire on your own. It tells you the things you need to know before you get your hands dirty under the hood and it covers the best tools and methods available to those who want to maintain their cars themselves rather than having someone else do it for them. 144 pages.

All..... #15760.. \$29.95/ea.

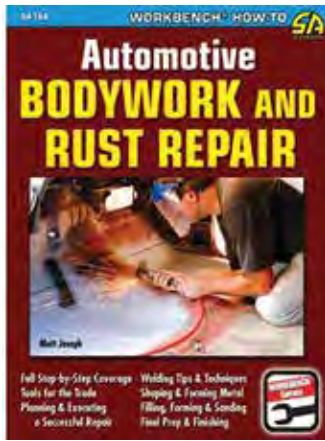

AUTOMOTIVE BODYWORK AND RUST REPAIR

In Automotive Bodywork and Rust Repair, veteran restorer Matt Joseph shows you the ins and out of tackling both simple and difficult rust and metalwork projects. This book teaches you how to select the proper tools for the job, common-sense approaches to the task ahead of you, preparing and cleaning sheet metal, section fabrications and repair patches, welding options such as gas and electric, forming, fitting and smoothing, cutting metal, final metal finishing including filling and sanding, the secrets of lead filling, making panels fit properly, and more. Also included is a comprehensive resource guide. 160 pages.

All #18847..... \$26.95



HOW TO PAINT YOUR CAR ON A BUDGET

Whether your car needs new paint or just a touch up, the cost involved in getting a professional job done can be more than you bargained for. Fortunately there are less expensive alternatives. This book covers everything from a simple scuff and squirt job to a full on door jambs and everything type paint job. You can even paint your car in your garage at home. This book covers the in's and out's of prep, masking, painting, sanding, use of different products and techniques. Everything you need to know to get a great looking coat of paint on your car while saving lots of money in the process. 128 pages.

All..... #15761.. \$29.95/ea.



PAINT AND BODY HANDBOOK

This book covers all the tools and welding techniques used to do top-quality sheet metal, paint, and body work. Information covering paint, paint products, and application equipment is included, as well as tips and techniques from expert restorers.

All..... #1866.... \$21.95/ea.



ELECTRO-VAC TAG

This tag is an exact reproduction of the original. The tag hangs from the Trico Vacuum Boost Pump.

1957 Fuel Injection
..... #12287.. \$39.95/ea.

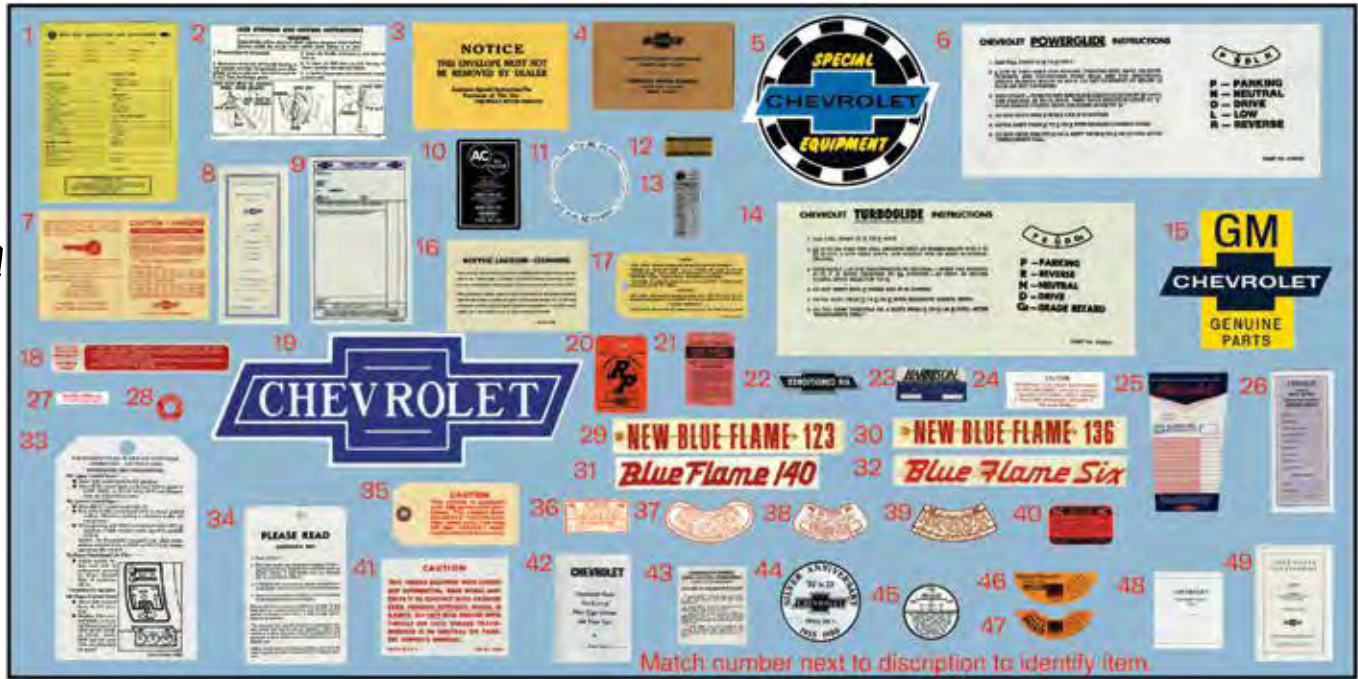

Match number next to description to identify item

ASSORTED DECALS, STICKERS AND INSTRUCTIONS

- 1. New Car Inspection Sheet, 1954-60.....#366K..... \$3.95/ea.
- 2. Jacking Instructions, 1955.....#642A..... \$3.95/ea.
Jacking Instructions, 1956.....#642B..... \$3.95/ea.
Jacking Instructions, 1957.....#642C..... \$3.95/ea.
Jacking Instructions, 1957 Wagon, Nomad, & Sed. Del.
.....#642D..... \$3.95/ea.
Jack Stowage Sheet, 54-60 Continental Kit.....#642E..... \$3.95/ea.
- 3. Chevrolet Envelope.....#509..... \$2.95/ea.
- 4. Owner's Maintenance Schedule Folder.....#518..... \$4.95/ea.
"Chevrolet Special Parts" Decal, 3".....#1766..... \$4.95/ea.
"Chevrolet Special Parts" Decal, 5".....#1767..... \$5.95/ea.
"Chevrolet Special Parts" Decal, 8".....#1768..... \$6.95/ea.
- 5. Sunvisor Sleeves 1955-57 Powerglide.....#999..... \$6.95/ea.
- 7. Breaking-in Instructions, 1955-57.....#366G..... \$3.95/ea.
Chevrolet Bowtie Decal, 7".....#1763..... \$4.95/ea.
- 8. Owner's Service Certificate, 1955-57.....#366M..... \$3.95/ea.
- 9. Factory Window Sticker, 1955-57 All Models.....#366V..... \$3.95/ea.
- 10. Oil Filter Decal, 1956-57 V8, 2BC, 4BC.....#643B..... \$3.95/ea.
Oil Filter Decal, 1955 (V8 w/A/C).....#643A..... \$3.95/ea.
- 11. Oil Filter Decal, 1955-57 6 Cyl., 1955 V8 w/o A/C
.....#641C..... \$3.95/ea.
- 12. Oil Breather Cap Decal, 1955-60 6 & 8 Cyl.....#643C..... \$3.95/ea.
- 13. Aluminum Service Record Tag, 1955-57.....#366D..... \$3.95/ea.
- 14. Sunvisor Sleeves 1957 Turboglide.....#1000..... \$6.95/ea.
- 15. "Genuine Chevrolet Parts" Decal, 8".....#1765..... \$4.95/ea.
- 16. Lacquer Paint Care Instructions, 1955-57.....#366L..... \$3.95/ea.
- 17. Heater Instruction Tag, 1955-56.....#366J..... \$3.95/ea.
- 18. Acrylic Paint Instruction Card, 1958-59.....#1749..... \$4.95/ea.
- 19. Chevrolet Bowtie Decal, 13".....#1764..... \$5.95/ea.
- 20. Lighter Instruction Tag, 1954-58, Rochester.....#1752..... \$4.95/ea.
- 21. Lighter Instruction Tag, 1949-59, Casco.....#1751..... \$6.95/ea.
- 22. Air Conditioned Window Decal, 1955-57.....#366C..... \$3.95/ea.
- 23. Air Conditioned Alum Tag, Harrison, 55-60.....#366A..... \$4.95/ea.
- 24. Air Conditioner Compressor Decal, 1955-60.....#366B..... \$3.95/ea.
- 25. Dealer Window Sticker, 1955-57.....#366W..... \$3.95/ea.
- 26. Delco Battery Guarantee, 1955-57 12 Volt.....#366F..... \$3.95/ea.
- 27. Antenna Adjustment Tag, 1955-57.....#366E..... \$3.95/ea.
- 28. Generator Warning Tag, 6 or 8 Cyl.....#366H..... \$3.95/ea.
- 29. Valve Cover Decal, '55 6 Cyl. Std, "Blue Flame 123"
.....#366R..... \$3.95/ea.

ASSORTED DECALS, STICKERS AND INSTRUCTIONS

- 30. Valve Cover Decal, '55 6 Cyl. Pwrgld, "Blue Flame 136"
.....#366S..... \$3.95/ea.
- 31. Valve Cover Decal, 1956-1960 6 Cyl., "Blue Flame 140"
.....#366T..... \$3.95/ea.
- 32. Valve Cover Decal, Early 6 Cyl. Psngr Cars & Vette
.....#366Q..... \$3.95/ea.
- 33. Dealer Installed Heat and Air Instrc., 1955-57
.....#1757..... \$4.95/ea.
- 34. Autronic Eye Instruction Tag, 1953-59.....#1754..... \$4.95/ea.
- 35. Radiator Tag, 1955-57.....#1251..... \$3.95/ea.
- 36. Air Cleaner Decal, 1949-54, Dry.....#641A..... \$3.95/ea.
- 37. Air Cleaner Decal, 1949-54, Oil Bath.....#641B..... \$3.95/ea.
- 38. Air Cleaner Decal, 1955-57.....#641D..... \$3.95/ea.
- 39. Air Cleaner Decal, 1955-57 V8, 2BC.....#641E..... \$3.95/ea.
- 40. Air Cleaner Decal, 1955-57 V8, 4BC.....#641F..... \$3.95/ea.
Air Cleaner Decal, 1957 V8, Dual 4BC.....#1434..... \$4.25/ea.
Air Cleaner Decal, 1957-59 F.I.....#1435..... \$3.95/ea.
- 41. Positraction Sticker, 1957-67 Vette & Psngr Car
.....#366N..... \$3.95/ea.
- 42. Chrome Care Instruction Folder, 1955-58.....#1750..... \$3.95/ea.
- 43. Compass Instruction Decal, 1937-59.....#1753..... \$5.95/ea.
- 44. Chevy Silver Anniv Window Decal, 1955.....#1760..... \$7.50/ea.
Chevy Silver Anniversary Window Decal, 1956
.....#1761..... \$7.50/ea.
Chevy Silver Anniversary Window Decal, 1957
.....#1762..... \$7.50/ea.
- 45. Tire Inflation Decal, 1955-60 Passenger Car.....#366P..... \$3.95/ea.
- 46. Windshield Washer Bottle Decal, 1955-57 Manual
.....#366X..... \$3.95/ea.
- 47. Windshield Washer Bottle Decal, 1955-57 Vacuum
.....#366Z..... \$3.95/ea.
Clock Instruction Folder, 1955-56.....#1758..... \$4.95/ea.
- 48. Clock Instruction Folder, 1957.....#1759..... \$4.95/ea.
- 49. Dealer's Accessory Price List, 1955.....#640D..... \$4.95/ea.
Dealer's Accessory Price List, 1956.....#640E..... \$4.95/ea.
Dealer's Accessory Price List, 1957.....#640F..... \$4.95/ea.
Dealer's Accessory Price List, 1958.....#640G..... \$4.95/ea.
Odometer, Black w/ White Numbers.....#14904..... \$7.95/ea.
Odometer, White w/ Black Numbers.....#14905..... \$7.95/ea.

15. Car Care

SECTION AT A GLANCE:

Danchuk Vintage	674
Auto Detailers	676
Polishers.....	677
Flitz Products.....	678
Adhesives & Sealants.....	680
Coolants	681
CRC Lubricants	682
Gasketmakers & Threadlockers.....	684
Amsoil Products	686
Race Ramps.....	688
Car Covers.....	690
Tools	692
AutoDollys	694

DANCHUK VINTAGE CAR CARE SYSTEM

After 60 years of washing, waxing and restoring cars, planes and boats, Dan and Art Danchuk have perfected a line of car care products that will clean, shine and protect your ride to the satisfaction of even the most passionate enthusiast. No expense was spared when we set out to formulate a superior line of products that go far beyond the average commercial brand. All our products are Made in the USA using only the most advanced quality ingredients. Try one or try them all but we guarantee you'll love every experience with our products!!!

DANCHUK VINTAGE "THE ESSENTIALS" 4-PACK CAR CARE PRODUCTS

All Spray Wax, Liquid Butter Wax, Wash 'N Wax, Premium Dress #17990..... \$49.95/kit

DANCHUK VINTAGE

DANCHUK VINTAGE SPRAY WAX

If you were only able to fit one item in the trunk of your beautiful classic you'd want it to be this amazing product. A special high-lubricity formula that actually encapsulates dust particles for a no-scratch clean, deep luster finish without using water! A fantastic daily wipe down for that driver of yours but an absolute must for your show car when you see the judges rounding the corner for their final inspection before the trophies get handed out. When dust, fingerprints and smudges are unacceptable there's Danchuk Vintage's Spray Wax!

All 16 oz #17969..... \$9.95/ea.



DANCHUK VINTAGE LIQUID BUTTER WAX

A must have for anyone with a love of beautiful, clean and silky smooth paint finishes. This soft, yellow, banana-scented thick cream wax contains a unique blend of silicones along with pure Brazilian carnauba wax for an unparalleled ease of use and flawless deep finish. Safe for all paints and will remove micro scratches.

All 12 oz #17970..... \$15.95/ea.



DANCHUK VINTAGE WASH N WAX

Put the dish soap back in the kitchen and use something designed for that awesome car of yours. This high performance cleaner and gloss enhancer cuts through heavy dirt and road film to leave surfaces clean and bright. Its non-irritating and pleasantly scented qualities make it great to work with, but the fast and easy results are enough to please any car enthusiast.

All 16 oz #17973..... \$8.95/ea.



DANCHUK VINTAGE PREMIUM DRESS

A premium, long lasting, high gloss dressing for both interiors and exteriors. Gives that protection and produces that "wet look" you want on your tires, rubber, vinyl, plastic, wood and leather. Helps prevent drying, cracking, fading and hardening of exterior surfaces. Give your ride that glistening new look with this great product.

All 16 oz #17975..... \$12.95/ea.





DANCHUK VINTAGE PREMIUM CARNAUBA WAX

Made from 100% pure Brazilian Carnauba wax, this product has been a favorite among professionals and fine car enthusiasts forever. Its effortless application and removal properties coupled with its harmless non-abrasive qualities makes it a must for the true car lover. This easy to use hard paste is applied and removed by hand and leaves your paint with a deep glossy wet look giving it the depth it deserves.

All 7 oz #17971 \$20.95/ea.

DANCHUK VINTAGE POLISHING WAX

Need to bring the life and luster back to that time tested paint? Look no further; this product is exactly what you need. This one step auto paint restoration eliminates oxidation, compounding marks and ultra fine scratches. Containing no harsh abrasives, this unique blend of pure Brazilian carnauba wax and modern resins combine to create a restorers dream product. Produces a swirl-free high gloss finish while forming a long lasting barrier and glass-like finish.

All 12 oz #17977 \$14.95/ea.



DANCHUK VINTAGE ALL PURPOSE CLEANER

The name says it all! This highly versatile cleaner effectively cleans engines, grillwork, rubber, plastic, vinyl, upholstery and carpet. This water-based cleaner/degreaser loosens and removes stubborn dirt and grime. Its high penetrating foam lifts and holds soil in suspension for easy rinsing and returning those surfaces to the glistening clean state you so love them to be in.

All 16 oz #17974 \$8.95/ea.



DANCHUK VINTAGE METAL POLISH

Made with aluminum oxide, this high end polish focuses all its qualities on the cleaning of dulling oxides, brake dust and oily soils from your cars metal surfaces. Great for getting the tough stuff off of chrome, copper, brass, aluminum, stainless steel and other metals to let their original beauty shine through. Not recommended for regular use on chrome. Due to this products mildly abrasive qualities it will eventually thin chrome plating. Non-abrasive wax is always best on chrome.

All 12 oz #17972 \$15.95/ea.



DANCHUK VINTAGE LEATHER CONDITIONER

Over time that beautiful natural leather interior that you so enjoy sitting on starts to lose its natural oils. This incredible non-greasy conditioner restores those hides back to their original look, feel and even scent. Our leather conditioner is scented like natural leather and is formulated to most resemble the natural moisturizers that once kept the leather supple.

All 12 oz #17976 \$10.95/ea.



CALIFORNIA CAR COVER COMPANY
"CALIFORNIA VERSADUSTER™"

The California Versaduster™ offers three important functions in one using detachable pads. (1) Treated Duster that has cotton strands with baked-on wax that literally "lifts" dust like a magnet. (2) Microfiber Duster that traps dust and dirt, and works on a wide variety of textures. (3) Microfiber Glass Cloths with a unique weave designed specifically for cleaning glass surfaces without chemicals. Need a little extra reach for those tight spaces? Simply pull the handle up, rotate it 180, and snap it back into place...it's as easy as 1-2-3. Great for cleaning dashboards, windshields, household glass & mirrors, and more. Complete kit includes Versa-Duster with removable/reversible handle, 1-Wax treated duster pad, 1-MicroFiber loop string duster pad, and 2-MicroFiber glass cloth bonnets.



All..... #15630..... \$25.95/ea.



ORIGINAL CAR DUSTER WITH BLACK CARRYING BAG

All..... #2336..... \$28.95/ea.



CALIFORNIA MINI-DUSTER

The Mini-Duster is just like the original, but only smaller. Great for interiors, Motorcycles and Home and Office. Comes with plastic handle only.

All..... #15631..... \$11.95/ea.



CALIFORNIA ORIGINAL & MINI-DUSTER COMBO

The Original and the best combined with the mini-duster will have you covered inside and out. The ONLY dusters with the baked in wax treatment that lifts dust off the surface reducing the number of washes.

All..... #15632 \$33.95/set



STAINLESS STEEL POLISHING KIT

All..... #17774.....\$42.95/kit



ALUMINUM POLISHING KIT

All #17775.....\$37.95/kit



3M BLACK SUPER WEATHERSTRIP ADHESIVE

Bonds gaskets and weatherstripping to metal surfaces. It withstands vibration and temperature changes; resists oils, fuels, detergents and grease to provide a strong and flexible bond. Danchuk recommends 3M weatherstrip adhesive always be used when you replace your door and trunk seals. 5 oz. tube. **Ground shipping only.**

All 5 oz #036..... \$13.95/ea.



CAULK STRIPS

60 one-foot strips per package.

All..... #2116..... \$29.95/ea.



"CALIFORNIA PLATINUM JELLY BLADE"

Featuring the same molded silicone technology as their original Water Blade, the Platinum Jelly Blade is the next step in Jelly Blade development. The "Platinum" still utilizes California Car Cover Company's patented t-bar edge, but features one piece 100% soft molded silicone construction for even smoother use and extreme flexibility. It is able to contour to the most unusual shapes and surfaces. All Jelly Blade models are great for not only automotive use, but excellent for windows, shower doors and many other household applications.

All..... #15634..... \$21.95/ea.



PHOTO COURTESY OF GERTMAN2000

FLITZ METAL, PLASTIC & FIBERGLASS POLISH

This high-performance cleaner and polisher is formulated to clean and polish with the ease and economy of a liquid, this concentrated formula goes three times farther than other liquids and leaves a brilliant shine in half the time. Cleans and polishes: brass, copper, silverplate, sterling silver, chrome, stainless steel, nickel, bronze, solid gold, aluminum, anodized aluminum, pewter, plastic and fiberglass. Removes: tarnish, rust, water stains, heat discoloration, oxidation and fingerprints. Not suitable for electroplated finishes. **Ground shipping only.**



All 7.6 oz Bottle..... #15588..... \$12.95/ea.



FLITZ METAL, PLASTIC & FIBERGLASS PASTE

Flitz Metal, Plastic & Fiberglass Polish & Paint Restorer Paste will never dry out, has an indefinite shelf life, is non abrasive, leaves no messy residues, non toxic and environmentally friendly. Flitz Polish Paste is a concentrated cream that is unequalled in its ability to clean, polish, deoxidize and protect all surfaces. **Ground Shipping Only.**

All 5.29 oz. Tube #15248..... \$19.95/ea.

FLITZ PVA DRYING CHAMOIS

With a unique 3D textured design, this is the industry's largest PVA towel! Perfect for use on boats, cars, trucks, shower surfaces, industrial equipment, pets, and more! The Grande Towel has excellent cooling properties; simply re-wet when dry to reactive the cooling sensation. 34" x 17".



All 24" x 17"..... #18912..... \$12.95/ea.

ORIGINAL FLITZ BUFF BALL

Made out of a material that resists tearing, ripping and doesn't shed lint. The buff ball polishes and waxes with speed and works on all surfaces. Attaches to a 3/8" or 1/2" drive drill.



All..... #15251..... \$27.95/ea.

FLITZ SUPER MINI BUFF BALL

If the larger Flitz Buffing Balls won't reach into those narrow crevices of your vehicle, the new, Super Mini 2" Flitz will. It not only has a smaller, ball surface, it also has a patented 8" shaft with a plastic sleeve to protect nearby surfaces.



All w/ Extension #15252..... \$28.95/ea.

FLITZ SPRAY SEALANT

This is a hydrophobic spray (meaning; immediate repelling of water) that is safe on All Metals, Fiberglass, Clear Coats, All Paints, Plastics, Granite, Glass, And All Man-Made Hard Surfaces. Helps protect against Salt, UV Rays, Water Stains, Bugs, Bird Droppings, and Yellowed Headlights. A completely water-based formula producing NO SWIRLS Flitz Sealant creates a "ceramic shell" type coating preventing from any harmful/damaging absorption to occur to your surface. Includes a free microfiber cloth for application. **Ground Shipping Only.**



All 8 oz Bottle..... #18911..... \$24.95/ea.

FLITZ ALUMINUM PRE-CLEAN SPRAY

Flitz aluminum pre-clean spray is much safer than traditional acids. It's organic salt formula is non-flammable and instantly removes heavily-encrusted corrosion, rust, calcium, lime, tarnish, grease, oil and water stains. It is also safe for use on painted and fiberglass surfaces. Not suitable for chrome, marble, some granite, jura, travertine and terrazzo. **Ground Shipping Only.**

All 16 oz. #15586..... \$14.95/ea.



FLITZ SPEED WAX®

Flitz Speed Wax® is a premium-grade detailing spray that's Perfect for when you're in a hurry and need a super-fast super shine. Made with Brazilian Carnauba, this remarkable spray-on, wipe-off wax product fills in swirls & hairline scratches. The product is water-based, environment friendly, no streak, and no smear. Leaves no white powdery residue. **Ground Shipping Only.**

All 16 oz Bottle..... #18910..... \$12.95/ea.



FLITZ MATT BLACK SPRAY CLEANER

A stunning clean doesn't always have to shine. Clean Flat / Matte surfaces the right way with this residue killing organic formula. One spray then clean and dry away with Flat / Matte Finish Cleaner! Removes fingerprints, oils, grease, soil, wax residue and carbon.

Ground Shipping Only.

All 16 oz Bottle..... #18913..... \$12.95/ea.



FLITZ WAX PROTECTANT

All 16-Ounce #15253..... \$24.95/ea.



PHOTO COURTESY OF GERTMAN2000



NEW GENERATION, DISC/DRUM WHEEL BEARING GREASE

A premium grease with drop point of over 500° F. This grease is designed for late model vehicles wheel bearings, chassis, suspension and u-joints. Extreme pressure additives. **Ground Shipping Only.**

All 14 oz Can #15934 \$5.95/ea.



CRC SYNTHETIC BRAKE & CALIPER GREASE

A specially developed synthetic grease with a high-tech formula for use in disc and drum brake systems. High temperature grease is plastic & rubber safe. Use on metal to metal contact points and sliding surfaces. Resists moisture and will not washout. **Ground Shipping Only.**

All 2.5 oz #15921 \$10.95/ea.

SILICONE DIELECTRIC GREASE

High energy (electronic) ignition systems generate so much heat in the plug wires that the wire connectors often fuse to the spark plug tips. Our dielectric grease, when applied to the plug contacts, prevents such fusing, 2 ounce. **Ground Shipping Only.**

All..... #2582..... \$14.95/ea.



AUTO BODY SEALANT

White, easy to apply sealant that is used for sealing interior and exterior auto body joints and seams. Applies easily and can be smoothed to a featheredge with a wet finger. Sets to a firm, rubber-like, water resistant bead. This sealant can be painted in 30 minutes, has easy water cleanup and will not harm paint.

Ground Shipping Only.

All 1/10 Gallon Cartridge, White ... #15883..... \$39.95/ea.



AUTO GLASS SEALANT

Medium viscosity, one part moisture curing urethane adhesive designed for windshield bonding and stationary glass attachment. Exceeds OEM strengths. **Ground Shipping Only.**

All 10.5 Cartridge #15884..... \$15.95/ea.



STA-LUBE OIL PUMP

Great for filling transmissions and rear ends. Dispenses 1-ounce with each depression. Fits all Sta-Lube quart, half-gallon and gallon bottles.

All..... #15936..... \$10.50/ea.



PHOTO COURTESY OF GERTMAN2000



EVANS WATERLESS HIGH PERFORMANCE COOLANT

Evans HPC has a boiling point of 375F while protecting down to -40 degrees and will not vaporize; eliminating boilover and after-boil preventing coolant loss and reduces strain on cooling systems. Since Evans contains no water it effectively eliminates corrosion and minimizes the potential for electrolysis and reduces maintenance costs. When converting an engine from water-based coolant to HPC, great care should be given during the conversion process to ensure that all the old water-based coolant is removed. It is recommended that the system be flushed with Evans Pre Fluid, part #18460, before installing Evans HPC. When the Conversion process is complete, the water content should be no more than 3%. Evans Coolant Conversion Kit, part #18461, contains test strip and other useful items to guarantee a perfect installation. **Ground Shipping Only. Made in the USA.**

All 1-Gallon #18459 \$46.95/ea.

EVANS WATERLESS COOLANT PREP FLUID

Ground Shipping Only.

All 1-Gallon #18460 \$32.95/ea.



TCI RACING TRANSMISSION FLUID

Ground Shipping Only.

All 1-Gallon #13228 \$23.95/ea.



BE COOLANT SUPER DUTY ANTIFREEZE

Be Coolant is a New Generation Propylene Glycol that has low toxicity, is biodegradable and is compatible with all colors and brands of anti-freeze. Be Coolant comes pre-mixed, ready to use and has a 7 year/300,000 mile extended life. It protects from -26F below zero and has a 267F boiling point (w-15psi). **Ground shipping only.**

All Premixed, 1-Gallon #15562 \$35.95/ea.

All Premixed, 2-Gallon #15563 \$69.95/pk.

GL-5 PLUS NEW GENERATION HD LIMITED SLIP GEAR OIL

GL-5 Heavy Duty Gear Oil is an extreme pressure, multi-purpose, automotive gear lubricant. Excellent performance for differentials operating under high speed, low torque; and low speed, high torque conditions. It meets SAE, military and commercial specs.

Ground Shipping Only.

All 75W-90, 32 oz #15935 \$11.95/ea.



STOR-X FUEL STABILIZER

Inhibits the formation of varnishes, peroxides & gums in gasoline, diesel fuel & aviation fuel during storage for up to 1 year. Does not contribute to induction system deposits. **Ground Shipping Only.**

All 8 oz #15932 \$7.95/ea.





CRC BRAKLEEN SPRAY

Removes brake fluid, grease, oil, and other contaminants quickly and effectively. Cleans & degreases brake parts, linings, calipers, drums and more! **Ground Shipping Only.**
All Non-Chlorinated, 14 oz.

..... #15918 \$4.95/ea.



CRC ENGINE DEGREASER

Engine Degreaser quickly lifts grease & grime off engines for cooler more efficient running. Easy to use - just spray on & rinse off. Leaves no residue. **Ground Shipping Only.**

All Low VOC Formula, 15 oz..... #15925..... \$4.95/ea.



CRC DISC BRAKE QUIET

Disc Brake Quiet forms a water resistant, high-temperature film that absorbs noise while quieting squeaks & squeals. Specially formulated to dampen the vibrations that cause brake noise. For use on the back of non-shimmed disc pads. **Ground Shipping Only.**

All 4 oz. Tube #15919 \$5.95/ea.



CRC CITRUS ENGINE DEGREASER

Powerful citrus cleaning formula dissolves and lifts off the toughest grease and road grime. **Ground Shipping Only.**

All 15 oz. #15927 \$5.95/ea.



CRC DE-SQUEAK BRAKE CONDITIONING TREATMENT

Prevents brake noises before they occur. Metallic-bonding formula fills grooves and imperfections in the friction surface that commonly cause squeaks & squeals. **Ground Shipping Only.**

All 11.25 oz. #15920 \$14.95/ea.



CRC ENGINE DEGREASER GEL

Penetrates & removes the most stubborn baked on engine greases & road grimes. Unique formula clings to all surfaces longer & penetrates deeper than conventional engine degreasers. **Ground Shipping Only.**

All 12 oz. #15926 ... \$4.95/ea.



CRC BATTERY CLEANER WITH ACID INDICATOR

Instantly detects leaks and neutralizes acid. Removes corrosion by-products. Just spray on and rinse off. **Ground Shipping Only.**

All 11 oz #15922 \$4.95/ea.



CRC BATTERY TERMINAL PROTECTOR

Specially designed to protect battery terminals from corrosion, a leading cause of hard starting and battery failure. Provides a lead-free soft protective coating. **Ground Shipping Only.**

All 7.5 oz #15923 \$6.95/ea.



CRC NICKEL ANTI-SEIZE LUBRICATING COMPOUND

Sta-Lube Nickel Anti-Seize is a nickel based formula that is free of copper, lead, sulfides and chlorides. This premium quality lubricant has extremely high temperature and excellent chemical resistance. **Ground Shipping Only.**

All 8 oz #15930 \$16.95/ea.



CRC TECHNICAL GRADE DI-ELECTRIC GREASE

A unique, non-curing compound used for sealing, protecting and electrical insulating. Improves electrical performance by reducing arcing, voltage drop and other conditions. Also ideal for the lubrication of plastic and rubber. Patented finger-actuated delivery system. **Ground Shipping Only.**

All 3.3 oz #15929 \$13.95/ea.



CRC CLEAN-R-CARB CARB CLEANER

A carb & choke cleaner that is designed to maximize carburetor performance. Quickly dissolves carburetor deposits such as gum, sludge & varnish to improve fuel system performance & enhance fuel economy. **Ground Shipping Only.**

All 16 oz #15924 ... \$4.95/ea.



CRC POWER LUBE MULTI-PURPOSE LUBRICANT

Fast acting multi-purpose lubricant. This all in one product quickly penetrates, lubricates, stops squeaks, fights corrosion & loosens rusted parts. **Ground Shipping Only.**

All 11 oz #15928 ... \$5.95/ea.



CRC FREEZE-OFF PENETRANT

A unique formula that immediately drops the temperature of the area in direct contact with the spray. The freezing effect cracks rusted surfaces, allowing Freeze-Off® to reach deeper & work more effectively than other penetrants. **Ground Shipping Only.**

All 11.5 oz #15931 ... \$5.95/ea.



GAGACINCH GASKET SEALER

Ground Shipping Only.

All 4 oz #13357 \$7.95/ea.

“THE RIGHT STUFF” GASKET MAKER

Return equipment to service immediately when you make leak-proof gaskets in just one minute with the Right Stuff.® This latest elastomeric rubber gasket technology is blowout resistant and outperforms pre-cut gaskets. Temperature range -75°F to 450°F continuous, 500°F intermittent.; resists ATF, coolant, oil and other shop fluids. Protects against leaks caused by vibration and thermal expansion. Sensor-safe. Suggested Applications: Automotive and marine gaskets, valve covers, gearbox covers, pumps, compressors, oil pans, thermostat housings, water pumps.



Ground Shipping Only.

All 7 oz Pressurized Can #15887 \$29.95/ea.

BLUE RTV SILICONE GASKET MAKER

OEM specified. Sensor-safe, low odor, noncorrosive. Outstanding oil resistance and joint movement values. Eight times more flexible than cork/composite gaskets; three times more oil resistant than conventional silicones. Temperature range -65°F to 500°F intermittent; resists auto and shop fluids and vibration. Suggested Applications: Valve covers, oil pans, timing covers, transmission pans, differential covers. **Ground Shipping Only.**



All 3.35 oz #15889 \$7.95/ea.

HIGH TEMP THREAD SEALANT

OEM specified. Locks and seals threaded fittings. Resists leakage, vibration loosening, moisture, hydraulic fluids and diesel fuels. Lubricates threads for easy assembly and disassembly. Won't shred or wear like Teflon® tape. Parts may be repositioned up to 4 hours after application. Temperature range from -65°F to 400°F. Contains PTFE. Suggested Applications: Head bolts into through holes, oil PSI sending units and sensors, oil and coolant lines, fuel fittings, rear axle fill plug, brake and power steering fittings. **Ground Shipping Only.**



All 50ML Tube #15888 \$16.95/ea.

ULTRA BLACK RTV GASKET MAKER

OEM specified. Fast-curing formula. Sensor safe, low odor, noncorrosive. Meets performance specs of OE silicone gaskets. Retains high flexibility, oil resistance properties through use of a patented adhesion system. Temperature range -65°F to 500°F intermittent; resists auto and shop fluids and vibration. Suggested Applications: valve covers, oil pans, intake manifold end seals, timing covers, transmission pans. **Ground Shipping Only.**



All 3 oz #15890 \$7.95/ea.

BLUE THREADLOCKER

All-purpose, medium strength threadlocker. Ideal for all nut and bolt applications 1/4" to 3/4". Eliminates need for stocking expensive lock nuts and lock washers. Locks and seals while preventing parts loosening due to vibration. Protects threads from corrosion. Removable with hand tools for easy disassembly. Suggested Applications: Valve cover bolts, water pump bolts, oil pan bolts, drive shaft bolts, rocker arm adjustment nuts, carburetor studs. **Ground Shipping Only.**



All Medium Strength, 6ML Tube #15885 \$7.95/ea.

ULTRA COPPER GASKET MAKER

OEM specified. Highest operating temperatures for turbocharged or high-performance engines. The most advanced, high temp RTV silicone gasket available. Sensor-safe, low odor, non-corrosive. Superior adhesion. Three times more oil resistant than conventional silicones; eight times more flexible than cut gaskets. Temperature range -75°F to 700°F (-59°C to 371°C) intermittent; resists auto and shop fluids and vibration. Suggested Applications: exhaust manifolds/ headers, valve covers, oil pans, timing covers, water pumps, thermostat housings. **Ground Shipping Only.**



All 3 oz Tube #15891 \$7.95/ea.

RED THREADLOCKER

High temperature/high strength threadlocker for heavy-duty applications. Prevents bolts and press fits 3/8" to 1" from loosening due to shock, severe vibration and heat stress. Exclusive formulation for newer engines and high performance applications that require extreme temperature resistance. Suited for temperatures up to 450°F. Removable with heat and hand tools. Suggested Applications: Camshaft sprocket bolts, crankshaft bolts, idler bearings, press fit filler tubes, transmission input and output shaft threads, ring gear or shock bolts. **Ground Shipping Only.**



All High Strength, 6ML Tube #15886 \$7.95/ea.

AMSOIL SYNTHETIC GEAR LUBE

AMSOIL Synthetic Manual Transmission and Transaxle Gear Lube is a premium blend of the finest synthetic base oils and advanced, high-performance additives. It is formulated specifically for maximum protection in the most demanding manual transmission and transaxle applications where an extreme pressure GL-4 gear lube is specified, including those where high horsepower/high torque engines and towing or heavy loads increase transmission stress.



All 75W-90, Standard Transmission/Transaxle #16303A \$15.95/ea.

AMSOIL ENGINE AND TRANSMISSION FLUSH

AMSOIL Engine and Transmission Flush helps restore fuel economy, increase operating efficiency and reduce emissions in gasoline and diesel engines, and automatic transmissions. Its potent, detergent-based formula cleans sludge and deposit build-up, promoting lower operating temperatures and reduced oil consumption. AMSOIL Engine and Transmission Flush is safe on parts and can be easily disposed of with waste oil. **Ground Shipping Only.**



All 16 oz #16324A \$10.25/ea.

AMSOIL SLIP-LOCK DIFFERENTIAL ADDITIVE

AMSOIL Slip-Lock™ Differential Additive. Formulated with advanced friction modifier. Designed to eliminate gear-housing chatter in cars, trucks and SUVs equipped with limited-slip, posi-traction and locking differentials. Formulated for use with both synthetic and petroleum gear lubricants and safely replaces manufacturer-recommended friction modifiers. **Ground Shipping Only.**



All 4 oz #16299A \$9.75/ea.

AMSOIL GEAR SEVERE GEAR SYNTHETIC GEAR LUBE

Engineered for high-demand applications, including trailer towing, heavy hauling, 4X4 off-road driving, commercial use and racing. Protects gears and bearings from scoring and wear. Excellent cold-flow properties. Outperforms all conventional gear oils. Recommended for all types of vehicles.



All 75W-90 #16298A \$17.95/qt.



AMSOIL SIGNATURE SERIES OIL

Whether you're running the latest LS conversion in your classic or just want the BEST synthetic oil for your daily driver. AMSOIL Signature series oils offer the best protection and performance and are designed for the extended drain intervals that newer application calls for. Pair it with one of Amsoils EA Oil filters (available by special order) and you could extend you change intervals up to 25,000 miles depending application.

- All 5W-30, 1 Qt #18217A..... \$11.95/ea.
- All 10W-30, 1 Qt #18218A..... \$11.95/ea.

AMSOIL DOMINATOR SYNTHETIC RACING OIL

AMSOIL Dominator® Synthetic Racing Oil provides superior performance and maximum protection in high-performance and racing applications. Formulated to withstand the elevated RPM, high temperatures and shock-loading common to racing applications, Dominator Synthetic Racing Oil delivers superior performance and maximum protection in extreme conditions. Ground shipping only.



- All 10W-30 #16296A..... \$12.95/qt.
- All 15W-50 #16297A..... \$13.95/qt.

AMSOIL SIGNATURE SERIES FUEL EFFICIENT ATF

AMSOIL Signature Series Synthetic Automatic Transmission Fluid is specifically formulated to withstand the rigors of heavy towing, elevated temperatures and challenging terrain. It remains fluid in sub-zero temperatures and provides reserve protection during heavy use and even abuse. For use in all applications requiring Dexron-VI.



- All 1-Qt #18221A..... \$13.95ea.

AMSOIL MOTOR OIL WITH ZINC

AMSOIL Synthetic Motor Oil is specially formulated to provide superior protection and performance in a wide variety of demanding applications. By incorporating high-quality synthetic base stocks and a superior high-zinc additive package, AMSOIL Premium Protection Oil exceeds the needs of large and small gasoline or diesel engines in cars, motorcycles, trucks, motor homes, maintenance equipment, heavy equipment, street rods and marine applications. It is ideal for high-mileage vehicles, vehicles with flat-tappet cams and high-stress vehicles subject to hot temperatures, heavy hauling, trailer pulling or off-road use. AMSOIL Premium Protection Oil resists oxidation, neutralizes acids, inhibits corrosion, reduces wear and protects against deposits. It provides the extra anti-wear protection required by engines with flat-tappet cams and high-tension valve springs. AMSOIL Synthetic 10W-40 Premium Protection Motor Oil offers flexibility and performance beyond conventional oil for convenience and trouble-free operation.



- All 10W-40 #16294A..... \$11.95/qt.
- All 20W-50 #16295A..... \$11.95/qt.

AMSOIL Z-ROD OIL

AMSOIL Z-ROD Synthetic Motor Oil is specially engineered for classic and high-performance vehicles. It features a high-zinc formulation to prevent wear on flat-tappet camshafts and other critical engine components, along with a proprietary blend of rust and corrosion inhibitors for added protection during long-term storage. Z-ROD Synthetic Motor Oil is designed to perform on the street and protect during storage.



- All 10W-30, 1 Qt #18219A..... \$11.95/ea.
- All 20W-50, 1 Qt #18220A..... \$11.95/ea.

AMSOIL BREAK-IN OIL

- All SAE30, 1 Qt..... #17378A..... \$8.95/ea.

AMSOIL DOMINATOR COOLANT BOOST

Provides Effective Heat Transfer and Enhanced Corrosion Protection. Dominator Coolant Boost is formulated with proprietary tiered surfactant technology, providing quick and effective heat transfer inside radiators and cylinder heads, which results in reduced operating temperatures, more efficient operation, increased horsepower and significantly reduced engine warm-up times in cold weather. Coolant Boost also contains a robust mixture of corrosion inhibitors that protect the radiator, heater core, water pump, cylinder heads, engine block and intake manifold from the damaging effects of corrosion. **Ground shipping only.**



All 16 oz #16305A..... \$13.95/ea.

AMSOIL SYNTHETIC POWER STEERING FLUID

AMSOIL Synthetic Universal Power Steering Fluid provides excellent wear protection. Its synthetic formulation delivers better lubricity and reduced friction, resulting in cooler operating temperatures, longer component life and quieter operation. AMSOIL Power Steering Fluid is formulated with a high viscosity index. Its low pour point ensures immediate lubrication at startup and in cold temperatures, yet it resists thermal breakdown and maintains maximum protection in high temperatures. **Ground shipping only.**



All 16 oz #16304A..... \$7.95/ea.

AMSOIL P.I. PERFORMANCE IMPROVER GASOLINE ADDITIVE

Improves fuel mileage an average of 2.3% and up to 5.7%. Reduces emissions such as hydrocarbons (HC) up to 15%, carbon monoxide (CO) up to 26% and nitrous oxides (NOx) up to 17%. Restores power and performance. Reduces the need for costly higher octane fuel. Reduces noise from carbon rap and pre-ignition. Offers better vehicle drivability and smoother operation. **Ground shipping only.**



All 12 oz #16307A..... \$12.95/ea.

AMSOIL SYNTHETIC MULTI-VEHICLE TRANSMISSION FLUID

AMSOIL Synthetic Multi-Vehicle Automatic Transmission Fluid is engineered to outperform conventional automatic transmission fluids and exceed the performance requirements of most North American, European and Asian vehicles. This sophisticated formulation provides outstanding performance and protection in the severe operating conditions of today's most advanced transmission designs. **Ground shipping only.**



All Auto #16300A..... \$11.95/ea.

AMSOIL SERIES 2000 OCTANE BOOST

Maximizes power and improves performance in all two-cycle and four-cycle gasoline engines. Increases octane number up to seven points. Reduces engine knock, improves ignition and engine response, helps fuel burn cleaner and inhibits corrosion. Recommended for off-road and racing use. **Ground shipping only.**



All 12 oz #16306A..... \$11.95/ea.

AMSOIL SUPER SHIFT SYNTHETIC RACING TRANSMISSION FLUID

Outstanding performance in high-performance, high-horsepower vehicles. Formulated without friction modifiers and viscosity improvers for positive clutch pack engagement and stable viscosity. Prevents slippage and lowers heat. Recommended for racing and street performance automatic transmissions. **Ground shipping only.**



All..... #16302A..... \$12.95/ea.

AMSOIL GASOLINE STABILIZER

Ground Shipping Only.

All 16 oz #17379A..... \$12.95/ea.



RACE RAMPS TRAK-JAX WITH STOPS

These lightweight, durable ramps get low cars up high enough to fit a standard floor jack under the car. At less than five pounds each and only 30.1" long, you can even fit them in the trunk of a C5 or C6 Corvette. These Trak-Jax have a 1.5" stop.

All..... #16028 \$99.95/ea.

RACE RAMPS 0/S

All Race Ramps products will not slide across a garage floor, dig into an asphalt driveway, or scratch or otherwise damage a cement or painted floor. They can be used on grass, dirt, or almost any other flat surface, and will never rust.

Race Ramp 56-2's are ideal for low ground clearance vehicles with tires up to 10" wide. With an incline of only 10.75°, they raise the car up 8" and hold up to 3,000 pounds per set while weighing only 10 pounds each. These are built in two pieces giving you easier access under the car.

All 2-Piece, 56"..... #16023.....\$249.95/pr.

Race Ramp XT2's are ideal for low ground clearance vehicles with tires up to 12" wide. With an incline of only 10.75°, they raise the car up 10" and hold up to 3,000 pounds per set while weighing only 15 pounds each. These are built in two pieces giving you easier access under the car.

All XT2, 2-Piece, 67" #16024\$359.95/pr.

56" Race Ramps are ideal for low ground clearance vehicles with tires up to 10" wide. With an incline of only 10.75 degrees, they lift your car up 8" and hold up to 3,000 pounds per set while weighing only 10 pounds per ramp. They are built in one solid piece, making them durable and sturdy.

All 1-Piece, 56" #16025 \$224.95/ea.

Race Ramp XTs are ideal for low ground clearance vehicles with tires up to 12" wide. With an incline of only 10.75°, they raise the car up 10" and hold up to 3,000 pounds per set while weighing only 15 pounds each. They are built in one solid piece, making them durable and sturdy.

All XT, 67", 1-Piece #16026 \$324.95/ea.



RACE RAMPS WHEEL CHOCKS

Wheel Chocks are ideal for use with all Race Ramp products, providing additional safety in the working environment. Made from solid rubber composite with an extra-grip bottom, they each weigh three pounds.

All Set of 4..... #16029..... \$64.95/set



WALL GUARD

Protect your car door from damage caused by hitting garage walls. Can be mounted to drywall, studs, or concrete and comes with mounting hardware.

All..... #10366..... \$12.95/ea.



FLATSTOPPERS

This product helps to keep your tires from flat spotting during long periods of storage. Once the tires are set in the FlatStoppers (on a level surface), they will settle into the pad's concave depression. More of the bottom portion of the tire will be fully supported, thus dispersing the weight of the car more evenly onto the tire and helping to prevent any flattening. FlatStoppers will not conduct heat or cold to your tires despite changing floor temperatures, will not damage your floor in any way, and will not slide.

All Set of 4 #16027 \$269.95/set



PARKING MAT

This mat allows the driver to drive over a first bump, which will signal them to stop. The second, larger bump tells the driver they've gone too far. Made of flexible, non-skid, rubber-like material that is oil and gasoline resistant, this parking mat is an excellent addition to any garage.

All..... #10365..... \$20.95/ea.

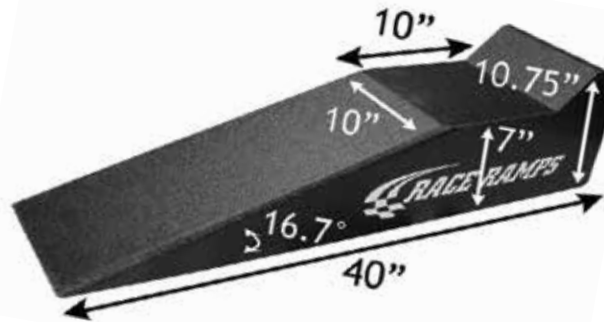

RACE RAMPS SPORT RAMPS

When car enthusiasts told us they wanted a simple, sleek ramp for them, we listened. The 40 inch Sport Ramp was built just for their needs. If you're looking for a no-fuss, lightweight and solid ramp for your sports car, then this is just for you. Sport Ramps are great for any type of maintenance or can even be used to help you show off your car at your local car show. These babies are ideal for most cars. Sport Ramps can handle tires up to 8 inches wide and raises your car up 7 inches -- basically, it's a sweet little ramp that gives you a lot of access.

All 40-Inch #18155..... \$149.95/pr.



RACE RAMP ROLL-UPS

Sometimes you need to raise your low profile car just a little bit extra to tackle those tougher tasks -- think changing your exhaust.. They're designed to be used along with our 56 inch or 67 inch Race Ramps to give you even more clearance for working on your low clearance vehicle for oil changing, tune ups or other maintenance. Roll Ups can raise the front or rear of the car to allow you to slide a standard floorjack in where you otherwise couldn't. And they're especially portable, weighing only 4.5 pounds each, ready to slip right into your trunk.

All..... #18156..... \$159.95/pr.



RACE RAMPS 6-INCH TRAILER RAMPS

Trailer Ramps RR-TR-6 is the third variation in our line of car loading ramps. Is your trailer door too steep to get your car to the race track or autocross? Are you tired of busting up your nose? Race Ramps has just the solution for you: simply place the trailer door on the notch of these specially designed Trailer Ramps and decrease your angle of approach.

All..... #18157..... \$279.95/pr.

SUPERWEAVE CUSTOM FIT CAR COVERS

The versatile Superweave material features unsurpassed moisture, dust and pollutant protection. The encapsulation technology goes INSIDE the fabric, around the fibers, resulting in a silky smooth finish that glides over fine paint finishes. Our Superweave Car Cover fabric is also dust-proof so it will keep your vehicle clean whether it is stored indoors or out. It still remains exceptionally breathable, allowing moisture, condensation and heat to easily escape from under the car cover. When rain hits the cover it simply runs right off and any moisture left on the cover will usually dry in about 10 minutes. Its unique lightweight design also enables it to fold up to 1/3 the size of your typical outdoor car cover (about the size of a sweatshirt or jacket), but does not take away from its ability to protect your automobile's finish. The material is also easy to care for because it is the only fabric that is washer and dryer safe. 4-year limited warranty.



1955-56 Grey, Except Wagon	#18430	\$346.95/ea.
1955-56 Grey, Wagon	#18431	\$434.95/ea.
1957 Grey, Except Wagon	#18432	\$346.95/ea.
1957 Grey, Wagon	#18433	\$434.95/ea.



POLY-COTTON CAR COVERS

Made of 50% cotton and 50% polyester, these car covers are both durable and safe for your car's finish. This fabric breathes, allowing heat to escape from your car, unlike 100% synthetic covers which often do more harm than good.

1957 Hardtop, Sedan, Convertible (Shown)	#649	\$239.95/ea.
1955-56 Hardtop, Sedan, Convertible	#649A	\$239.95/ea.
1957 Nomad, Station Wagon, Sedan Delivery	#650	\$239.95/ea.
1955-56 Nomad, Station Wagon, Sedan Delivery	#650A	\$239.95/ea.

FLANNEL CAR COVERS (NOT SHOWN)

Our flannel car covers are slightly heavier than the poly-cotton covers. They have a super-soft flannel weave that protects your car from scratching while allowing damaging heat to escape. Note: Not for outside use.

1955-56 Hardtop, Sedan, Convertible	#1107	\$285.95/ea.
1955-56 Nomad, Wagon, Sedan Delivery	#1109	\$285.95/ea.
1957 Hardtop, Sedan, Convertible	#1106	\$285.95/ea.
1957 Nomad, Wagon, Sedan Delivery	#1108	\$285.95/ea.

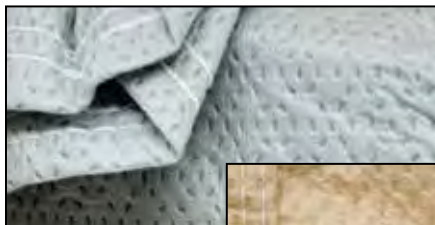

ALL-WEATHER CAR COVERS

Due to popular demand, Danchuk now offers custom fit covers that are made to handle the elements, indoor and out. The Multiweave 2 fabric uses a 3 layer non-woven fabric that offers great protection at an affordable price. The NOAH fabric uses “breathable-film” technology that stops virtually all dust, dirt and pollution, is highly water resistant, but still breathable to allow moisture to evaporate giving your classic the ultimate barrier of protection in all weather conditions. From California Car Covers.

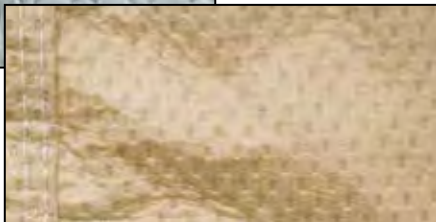

- 1955-56 MultiWeave 2, Tan, Except Wagon**
..... #14868..... \$239.95/ea.
- 1955-56 MultiWeave 2, Tan, Wagon**
..... #14869..... \$269.95/ea.
- 1955-56 NOAH, Grey, Except Wagon**
..... #14870..... \$299.95/ea.
- 1955-56 NOAH, Grey, Wagon** #14871..... \$349.95/ea.
- 1957 MultiWeave 2, Tan, Except Wagon**
..... #14872..... \$239.95/ea.
- 1957 MultiWeave 2, Tan, Wagon..** #14873..... \$269.95/ea.
- 1957 NOAH, Grey, Except Wagon..** #14874..... \$299.95/ea.
- 1957 NOAH, Grey, Wagon.....** #14875..... \$349.95/ea.

SPARE TIRE COVERS

What do you do when your resto project is done? Detail the trunk. Our beautifully made spare tire covers give the trunk that finished look, and protect the tire from bumps and scratches. Both vinyl and felt covers include storage pockets.



- 1955-57 Felt** #893..... \$34.95/ea.
- 1955-57 Vinyl (Shown)**..... #892..... \$34.95/ea.



BRAS

Designed specifically for the 1955, 1956, and 1957 Chevys, these bras are patterned for a glove fit. 1955 and 1957 bras are available with or without bumper guard cutouts. The 1956 bra covers both bumper configurations. Our bras are made with heavy, 32 ounce vinyl, backed by a super-soft, mildew resistant fabric. Sewn-in screen inserts let the air in but keep the bugs out. Protect your front end with style!

- 1955 w/out Bumper Guards** #878..... \$141.95/ea.
- 1955 w/ Bumper Guards**..... #878B..... \$141.95/ea.
- 1956 w/out Bumper Guards** #879..... \$141.95/ea.
- 1956 w/ Bumper Guards**..... #879B..... \$141.95/ea.
- 1957 w/out Bumper Guards** #880..... \$141.95/ea.
- 1957 w/ Bumper Guards (Shown)..** #880B..... \$141.95/ea.



DASH COVER

Keep that meticulously-restored dash looking like new. This black vinyl dash cover is fashioned of the same material used to make the bra and spare tire cover. Cover includes magnetic tabs to hold it in position on the dash and a cover for the steering wheel.

- 1955-57** #869..... \$29.95/ea.

CAR COVER LOCK KIT

Protect your car cover from theft with this plastic coated cable and lock. Kit includes grommets and iron-on patches to custom fit any car cover.

- All**..... #944..... \$15.95/set



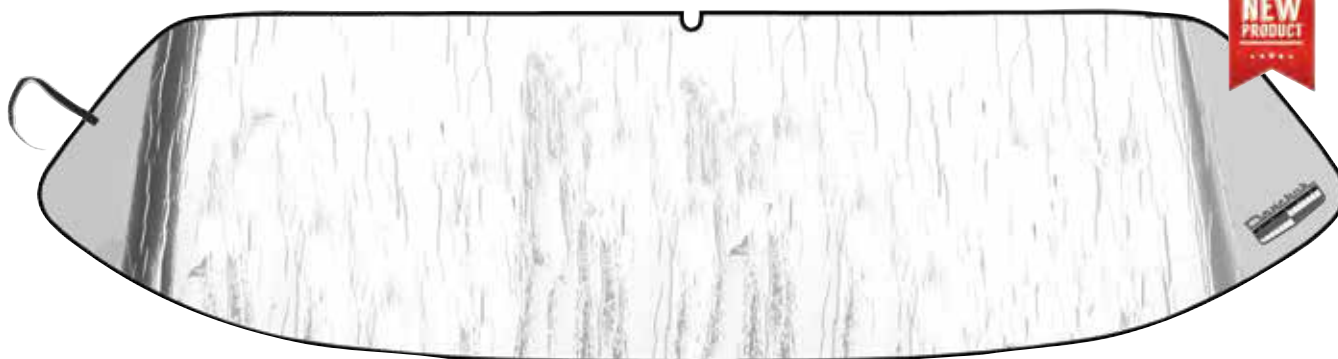

CUSTOM TRI-FIVE WINDSHIELD SHADES

1955-56	#19404.....	\$39.95/ea.
1957.....	#19405.....	\$39.95/ea.



HOSE END WRENCHES

All 6 AN	#14495.....	\$28.95/ea.
All 8 AN	#14496.....	\$27.95/ea.
All 10AN	#14497.....	\$27.95/ea.



ADJUSTABLE AN FITTING WRENCH

This wrench works with any brand AN or hex fitting. Its billet aluminum construction helps in preventing marring or scratches.

All.....	#18515.....	\$55.95/ea.
----------	-------------	-------------



CLUTCH HEAD SCREWDRIVERS

This 4-piece set should cover all your needs when restoring your classic Chevy.

All 4-Piece Set	#16367.....	\$21.95/set
-----------------------	-------------	-------------



HOSE & FITTING ASSEMBLY LUBE AND SEALANT KIT

All.....	#14494.....	\$15.95/kit
----------	-------------	-------------



NOTCHEAD LINE CLAMP SHOP BUILDER KITS

Upgrade from metal line clamps to NotcHead Line Clamps. Made from Copolymer Acetal plastic, NotcHead Line Clamps are heat-resistant with a melting point of 330° F, are very wear resistant and easy on painted parts. The centered set screw means you drill and tap holes right where you want your line to go. Lines easily snap into the clamp with a push of your finger. The shop builder hard line kit contains: 18 of 3/16", 10 of 1/4", 18 of 3/8" and 10 of 1/2" line clamps and all necessary hardware. The shop builder soft line kit contains: 12 of 1/2" heater hose and #6 AC, 18 of 5/8" heater hose and #8 AC, 18 of 3/4" heater hose and #10 AC line clamps and all necessary hardware.

- All 56 Clamps Hardline #18852.....\$170.95/kit
- All 48 Clamps Softline #18853.....\$179.95/kit



NOTCHEAD HARDLINE CLAMP KITS

- All 3/16", 6-Piece..... #18854.....\$16.95/kit
- All 1/4", 6-Piece..... #18855.....\$17.95/kit
- All 3/8", 6-Piece..... #18856.....\$18.96/kit
- All 1/2", 6-Piece..... #18857.....\$22.95/kit



NOTCHEAD SOFTLINE CLAMP KITS

- All 1/2" Heater/#6 AC Hose, 6-Piece #18858..... \$22.95/kit
- All 5/8" Heater/#8 AC Hose, 6-Piece #18859..... \$24.95/kit
- All 3/4" Heater/#10 AC Hose, 6-Piece #18860..... \$26.95/kit



THANKS FOR POSTING TO FACEBOOK!



AUTO DOLLY STANDARD

The Auto Dolly will quickly become one of the handiest tools in your garage, shop, or showroom. It was designed to allow one-person to move automobiles, trucks, boats & trailers, lawn mowers, jet skis, motorcycles, airplanes, and most other heavy vehicles with ease. Gain precious floorspace by moving items right up against a wall or into a corner! Each standard Auto Dolly is rated to hold 1,500lbs.

- All 12 x 16, Set of 4 #16352..... \$149.95/ea.
- All 12 x 16, Set of 2 #16353..... \$81.95/ea.



ENGINE DOLLY ATTACHMENT

- Turns a single Auto Dolly into a highly moveable engine/transmission dolly.
- “Gentle-V” design provides self-centering stability
- Free up storage space in your garage or shop: Easily move engines aside, even under a workbench.
- Facilitates shop or garage orderliness and efficient floor cleaning.

All Standard #16354 \$45.95/ea.

AUTO DOLLY ROLL AROUND

The Roll-Around attachment will fit a 12” or 16” Auto Dolly (Standard or Heavy Duty). Once attached, you have unimpeded access to the wheel well areas (with the tires/wheels removed) and yet can still move your vehicle in any direction. A real boon to auto restoration projects, painting and body work.



All Set of 2 #16374..... \$129.95/ea.



DOLLY DOCK

A simple, yet ingenious, way to store your Auto Dolly sets when not in use. Works for any size Dolly.

- Mounts easily on the wall of your garage or shop
- Works with Auto Dolly or Auto Dolly Heavy Duty (any size)
- Helps remove clutter from garage floor and helps keep your shop organized
- Powder Coat finish

All Holds 4 #16355 \$33.95/ea.



ENGINE STAND AXLE ADAPTER

The Engine Stand Axle Adapter allows you to convert any ordinary engine stand into a powerful and versatile axle workstation. Get double duty from your engine stand! The Engine Stand Axle Adapter allows you to securely hold an axle or transaxle at a comfortable height. Pivot the axle or rotate it within it's holder to facilitate easy access to the part on which you are working or painting. Fits virtually every engine stand available. Just bolt it on and go to work!

All..... #16356..... \$54.95/ea.

16. Gifts & Apparel

SECTION AT A GLANCE:

Danchuk Tees.....	696
Chevy Tees.....	699
Hats.....	702
Miscellaneous Gifts.....	704
Signs & Posters.....	706



CATALOG 37 - DANCHUK MADE IN THE USA TEE SHIRTS

Great new tee design featuring all 3 years! Available in black and white, mens and womens tees. **Made in the USA.**

Mens WHITE M-3XL#19392	\$20.00/ea.	Womens WHITE M-XL.....#19394	\$20.00/ea.
Mens BLACK M-3XL#19393	\$20.00/ea.	Womens WHITE M-XL.....#19395	\$20.00/ea.

DANCHUK MADE IN THE USA SWEATSHIRTS

All Crew, White, Medium.....#19491M.....	\$19.95/ea.	All Hoodie, Black, Medium..#19494M.....	\$32.95/ea.		
All Crew, White, Large	#19491L.....	\$19.95/ea.	All Hoodie, Black, Large.....#19494L.....	\$32.95/ea.	
All Crew, White, X-Large	#19491XL.....	\$22.95/ea.	All Hoodie, Black, X-Large ..#19494XL.....	\$34.95/ea.	
All Crew, White, XX-Large ...#19491XXL.....	\$22.95/ea.	All Hoodie, Black, XX-Large #19494XXL.....	\$34.95/ea.		
All Crew, White, XXX-Large .#19491XXXL.....	\$22.95/ea.	All Hoodie, Black, XXX-L.....#19494XXXL.....	\$34.95/ea.		
All Crew, Black, Medium	#19492M.....	\$19.95/ea.	All Zip, White, Medium.....#19495M.....	\$45.95/ea.	
All Crew, Black, Large.....#19492L.....	\$19.95/ea.	All Zip, White, Large	#19495L.....	\$45.95/ea.	
All Crew, Black, X-Large	#19492XL.....	\$22.95/ea.	All Zip, White, X-Large	#19495XL.....	\$47.95/ea.
All Crew, Black, XX-Large ...#19492XXL.....	\$22.95/ea.	All Zip, White, XX-Large	#19495XXL.....	\$47.95/ea.	
All Crew, Black, XXX-Large .#19492XXXL.....	\$22.95/ea.	All Zip, White, XXX-Large#19495XXXL.....	\$47.95/ea.		
All Hoodie, White, Medium..#19493M.....	\$32.95/ea.	All Zip, Black, Medium.....#19496M.....	\$45.95/ea.		
All Hoodie, White, Large	#19493L.....	\$32.95/ea.	All Zip, Black, Large	#19496L.....	\$45.95/ea.
All Hoodie, White, X-Large ..#19493XL.....	\$34.95/ea.	All Zip, Black, X-Large	#19496XL.....	\$47.95/ea.	
All Hoodie, White, XX-Large #19493XXL.....	\$34.95/ea.	All Zip, Black, XX-Large	#19496XXL.....	\$47.95/ea.	
All Hoodie, White, XXX-L.....#19493XXXL.....	\$22.95/ea.	All Zip, Black, XXX-Large#19496XXXL.....	\$47.95/ea.		



DANCHUK'S 2019 DRAG RACING SCENE TEE SHIRTS

Mens, White, Medium	#2019M	\$16.95/ea.
Mens, White, Large	#2019L	\$16.95/ea.
Mens, White, XL	#2019XL	\$16.95/ea.
Mens, White, XXL	#2019XXL	\$17.95/ea.
Mens, White, XXXL	#2019XXXL	\$18.95/ea.
Mens, Black, Medium	#2019BM	\$16.95/ea.
Mens, Black, Large	#2019BL	\$16.95/ea.
Mens, Black, XL	#2019BXL	\$16.95/ea.
Mens, Black, XXL	#2019BXXL	\$17.95/ea.
Mens, Black, XXXL	#2019BXXXL	\$18.95/ea.

Womens, White, Medium	#2019WM	\$16.95/ea.
Womens, White, Large	#2019WL	\$16.95/ea.
Womens, White, XL	#2019WXL	\$16.95/ea.
Womens, Black, Medium	#2019WBM	\$16.95/ea.
Womens, Black, Large	#2019WBL	\$16.95/ea.
Womens, Black, XL	#2019WBXL	\$16.95/ea.

DANCHUK'S 2018 TRI-FIVE NATIONALS SCENE TEE SHIRTS

Mens, White, Medium	#2018M	\$16.95/ea.
Mens, White, Large	#2018L	\$16.95/ea.
Mens, White, XL	#2018XL	\$16.95/ea.
Mens, White, XXL	#2018XXL	\$17.95/ea.
Mens, White, XXXL	#2018XXXL	\$18.95/ea.
Mens, Black, Medium	#2018BM	\$16.95/ea.
Mens, Black, Large	#2018BL	\$16.95/ea.
Mens, Black, XL	#2018BXL	\$16.95/ea.
Mens, Black, XXL	#2018BXXL	\$17.95/ea.
Mens, Black, XXXL	#2018BXXXL	\$18.95/ea.

Womens, White, Medium	#2018WM	\$16.95/ea.
Womens, White, Large	#2018WL	\$16.95/ea.
Womens, White, XL	#2018WXL	\$16.95/ea.
Womens, White, XXL	#2018WXXL	\$17.95/ea.
Womens, White, XXXL	#2018WXXXL	\$18.95/ea.
Womens, Black, Medium	#2018WBM	\$16.95/ea.
Womens, Black, Large	#2018WBL	\$16.95/ea.
Womens, Black, XL	#2018WBXL	\$16.95/ea.
Womens, Black, XXL	#2018WBXXL	\$17.95/ea.



All of the Danchuk tee shirts have a small Danchuk logo embelished in the upper left chest area.



DANCHUK TRI-FIVE EVOLUTION TEE SHIRTS

- Black L..... #19294L \$15.95/ea.
- Black XL..... #19294XL ... \$15.95/ea.
- Black XXL..... #19294XXL . \$17.95/ea.

DANCHUK LOGO TEE SHIRTS

- Black, Small.....#18527S..... \$15.95/ea.
- Black, Medium#18527M..... \$15.95/ea.
- Black, Large#18527L..... \$15.95/ea.
- Black, XLarge#18527XL.... \$15.95/ea.
- Black, 2X-Large.....#18527XXL.. \$16.95/ea.
- Black, 3X-Large.....#18527XXXL \$17.95/ea.



1955 "SEE YA" TEE SHIRTS

- 1955 Large #12649.. \$15.95/ea.
- 1955 XL..... #12650.. \$15.95/ea.
- 1955 XXL..... #12651.. \$16.95/ea.

1956 "SEE YA" TEE SHIRTS

- 1956 Large #12652.. \$15.95/ea.
- 1956 XL..... #12653.. \$15.95/ea.
- 1956 XXL..... #12654.. \$16.95/ea.

1957 "SEE YA" TEE SHIRTS

- 1957 Large #12655.. \$15.95/ea.
- 1957 XL..... #12656.. \$15.95/ea.
- 1957 XXL..... #12657.. \$16.95/ea.



55 AND STILL ALIVE TEE SHIRTS

White, Large..... #1061.... \$19.95/ea.
 White, X-Large... #1062.... \$19.95/ea.



HEARTBEATS CHEVY TEE SHIRTS

White, Large..... #1067.... \$19.95/ea.
 White, X-Large... #1068.... \$19.95/ea.



CLASSIC CHEVROLET TEE SHIRTS

White, Large..... #066..... \$17.95/ea.
 White, X-Large... #068..... \$17.95/ea.



BLUE SUEDE 56 TEE SHIRTS

All White, Large..... #18879..... \$16.95/ea.
 All White, X-Large..... #18880..... \$16.95/ea.
 All White, XX-Large..... #18881..... \$18.95/ea.



GENUINE CLASSICS TEE SHIRTS

All White, Large..... #18876..... \$16.95/ea.
 All White, X-Large..... #18877..... \$16.95/ea.
 All White, XX-Large..... #18878..... \$18.95/ea.

#19121



#18874

#19104



#19103



GM ACCESSORIES LOGO TEE SHIRTS

- Tan, L..... #18873..... \$17.95/ea.
- Tan, XL..... #18874..... \$17.95/ea.
- Tan, XXL..... #18875..... \$19.95/ea.

CHEVY SPIRIT OF FREEDOM TEE SHIRTS

- XX-Large, Red.... #19121XXL \$19.95/ea.

CHEVROLET CENTURY LEGENDARY TEE SHIRTS

- Red, L #19103L \$18.95/ea.
- Red, XL #19103XL.. \$18.95/ea.
- Red, XXL #19103XXL \$20.95/ea.
- Black, L..... #19104L \$18.95/ea.
- Black, XL..... #19104XL.. \$18.95/ea.
- Black, XXL..... #19104XXL \$20.95/ea.

AMERICAN HERITAGE TEE SHIRTS

- Heather Blue, L.. #19102L \$19.95/ea.
- Heather Blue, XL #19102XL.. \$19.95/ea.
- Heather Blue, XXL
..... #19102XXLL\$21.95/ea.

#19102



#18754



#18868



#18871



#19105



#10024

55, 56 57 GOLDEN YEARS TEE SHIRTS

All Grey, L	#18753.....	\$16.95/ea.
All Grey, XL	#18754.....	\$16.95/ea.
All Grey, XXL	#18755.....	\$18.95/ea.

GM GENUINE PARTS TEE SHIRTS

Black, L.....	#19105L.....	\$17.95/ea.
Black, XL.....	#19105XL...	\$17.95/ea.
Black, XXL.....	#19105XXL.	\$19.95/ea.

SOLO SPEED 55 CHEVY TEE SHIRTS

All Black, L.....	#18867.....	\$17.95/ea.
All Black, XL.....	#18868.....	\$17.95/ea.
All Black, XXL.....	#18869.....	\$19.95/ea.

MAKE MINE A BIG BLOCK BLACK TEE SHIRTS

Black, L.....	#10024.....	\$18.95/ea.
Black, XL.....	#10025.....	\$18.95/ea.

SOLO SPEED 57 CHEVY SAN FERNANDO FLYER TEE SHIRTS

All Black, L.....	#18870.....	\$17.95/ea.
All Black, XL.....	#18871.....	\$17.95/ea.
All Black, XXL.....	#18872.....	\$19.95/ea.



MEN'S TRI-CHEVY CAMP SHIRTS

- All Navy Blue, Medium #16308..... \$29.95/ea.
- All Navy Blue, Large..... #16309..... \$29.95/ea.
- All Navy Blue, XL #16310..... \$29.95/ea.
- All Navy Blue, XXL #16311..... \$29.95/ea.
- All Navy Blue, XXXL #16312..... \$29.95/ea.



CHEVROLET WOMENS TEE SHIRTS

- Royal, Small #19109S..... \$21.95/ea.
- Royal, Medium..... #19109M..... \$21.95/ea.
- Royal, Large #19109L \$21.95/ea.
- Royal, X-Large #19109XL ... \$21.95/ea.
- Royal, XX-Large #19109XXL . \$23.95/ea.
- Pink, Small..... #19110S..... \$21.95/ea.
- Pink, Medium #19110M..... \$21.95/ea.
- Pink, Large..... #19110L \$21.95/ea.
- Pink, X-Large..... #19110XL ... \$21.95/ea.
- Pink, XX-Large..... #19110XXL . \$23.95/ea.

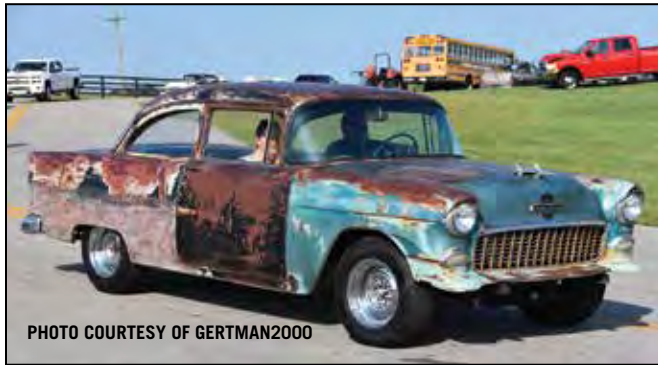

PHOTO COURTESY OF GERTMAN2000



PHOTO COURTESY OF GERTMAN2000



PHOTO COURTESY OF GERTMAN2000



“CHEVROLET” PATRIOT HATS

All Olive #19108..... \$17.95/ea.

“CHEVROLET” FLEXFIT FLATBILL HATS

All Black #19113..... \$18.95/ea.
 All Gray #19114..... \$18.95/ea.
 All Black & Gray #19115..... \$18.95/ea.
 All Black & Red #19116..... \$18.95/ea.

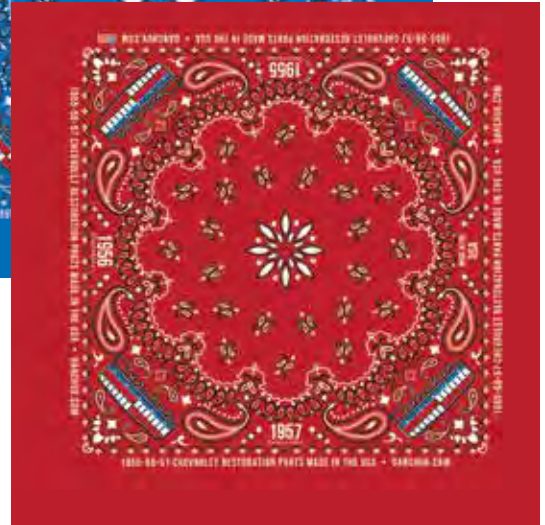

DANCHUK BANDANAS

Don't miss out on one of these limited edition Tri-Five bandanas with the Danchuk logo. Always handy and available in red and blue, these are always handy for all Tri-Five enthusiasts. **Made in the USA.**

All..... #BLUE \$5.00/ea.
 All #RED \$5.00/ea.



“CHEVROLET MOTOR COMPANY” HATS

All Charcoal #19111..... \$16.95/ea.
 All Cream #19112..... \$16.95/ea.



FLEX FIT NAVY BLUE DANCHUK HAT WITH BLUE AND SILVER SHIELD

All S/M..... #15508..... \$18.95/ea.
 All LG/XL #15509..... \$18.95/ea.

FLEX FIT BLACK DANCHUK HAT WITH RED SHIELD

All S/M..... #15510..... \$18.95/ea.
 All LG/XL #15511..... \$18.95/ea.



PHOTO COURTESY OF GERTMAN2000



BACK OF COMFORT STOOL



"BEL AIR" COMFORT COUNTER STOOL **Q/S**

"BEL AIR" COUNTER STOOL

All..... #14245..... \$149.95/ea.

All..... #14244.. \$99.95/ea.



HULA DOLLS

All Natural Skirt with Ukelele #19489..... \$10.95/ea.

All Green Skirt with #19490..... \$10.95/ea.



#18449

SMALL ALUMINUM CAR HOP TRAY

All 10-3/4" x 13-3/4" #18448..... \$42.95/ea.

LARGE ALUMINUM CAR HOP TRAY

All 12-1/2" x 17" #18449..... \$45.95/ea.



“CHEVROLET SUPER SERVICE”

All Thermometer, 12” Diameter..... #19117..... \$31.95/ea.
 All Clock, 12” Diameter #19118.....\$31.95

“GENUINE CHEVROLET PARTS”

All Thermometer, 12” Diameter..... #19119..... \$31.95/ea.
 All Clock, 12” Diameter #19120.....\$31.95



DANCHUK KEY FOB

These are die-cut and have a beautiful color raised image.
 All..... #17795..... \$1.95/ea.



FUZZY DICE

No fifties favorite is complete without this collectible!
 Black #248..... \$7.95/pr.
 Blue #248C..... \$7.95/pr.
 Red #248F \$7.95/pr.
 White #248G..... \$7.95/pr.



#2751



#218

LICENSE PLATES

“USA-1” #218..... \$7.95/ea.
 “Heartbeat of America-Bel Air”, Red
 #2392..... \$6.95/ea.



CHROME BULLET NOVELTIES

Finish off a beautiful set of wheels; use our dazzling chrome decoratives to highlight your classic.
 Valve Stem Caps #1264..... \$6.95/set
 License Bolts #1265..... \$6.95/set



HOT ROD MAGAZINE HAT PIN

This hard-to-find baked enamel pin is highly detailed and have been collectors’ favorites for years.
 1989 Centerfold #2459..... \$4.95/ea.



"GENUINE CHEVROLET SALES SERVICE" SIGN

14.25" wide by 17.5" high.

All Flange, Red, #15476..... \$64.95/ea.



"CHEVROLET OK USED CARS" SIGN

26" wide by 29" high.

All Hanging, Red/White #15485..... \$149.95/ea.



"GENUINE CHEVROLET PARTS" SIGN

17.5" wide by 23" high.

All Arrow, Red #15484..... \$89.95/ea.



"TEXACO FILLING STATION" SIGN

14.25" wide by 17.5" high.

All Flange, Red #15477..... \$64.95/ea.



"GENUINE CHEVROLET SALES SERVICE" SIGN

15" wide by 10" high.

All Spinner, Black #15478..... \$73.95/ea.



"TEXACO FILLING STATION" SIGN

15" wide by 10" high.

All Spinner, White..... #15480..... \$69.95/ea.

"ROUTE 66 FILLING STATION" SIGN

15" wide by 10" high.

All Spinner, Black #15481..... \$79.95/ea.

"TEXACO SKY CHIEF STATION" SIGN

15" wide by 10" high.

All Spinner, White..... #15479..... \$69.95/ea.

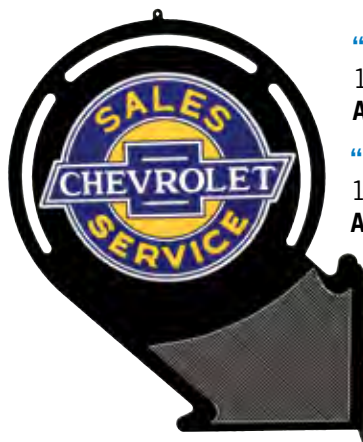

"CHEVROLET SUPER SERVICE" SIGN

17.5" wide by 23" high.

All Arrow, Black..... #15482..... \$77.95/ea.

"ROUTE 66" SIGN

18" wide by 24" high.

All Arrow, Black..... #15483..... \$79.95/ea.

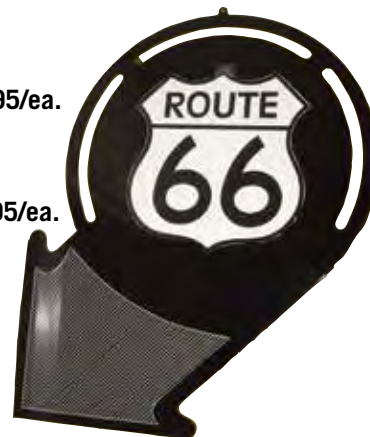



ALUMINUM DANCHUK SIGN

Nothing says true "Tri-Five enthusiast" better than your very own aluminum Danchuk sign hanging in your garage or man cave! Our aluminum, die cut and embossed Danchuk logo sign is made by American Metal Signs and measures 35" wide by 14" tall. **Made in the USA.**

All..... #SIGN \$39.95/ea.



TOM "THE MONGOOSE" MCEWEN'S 1957 FUNNY CAR

18" x 39"..... #1242..... \$4.00/ea.



DANCHUK POSTERS AUTOGRAPHED - 24" X 18"

1955..... #16602..... \$2.95/ea.
 1956..... #16603..... \$2.95/ea.
 1957..... #16604..... \$2.95/ea.

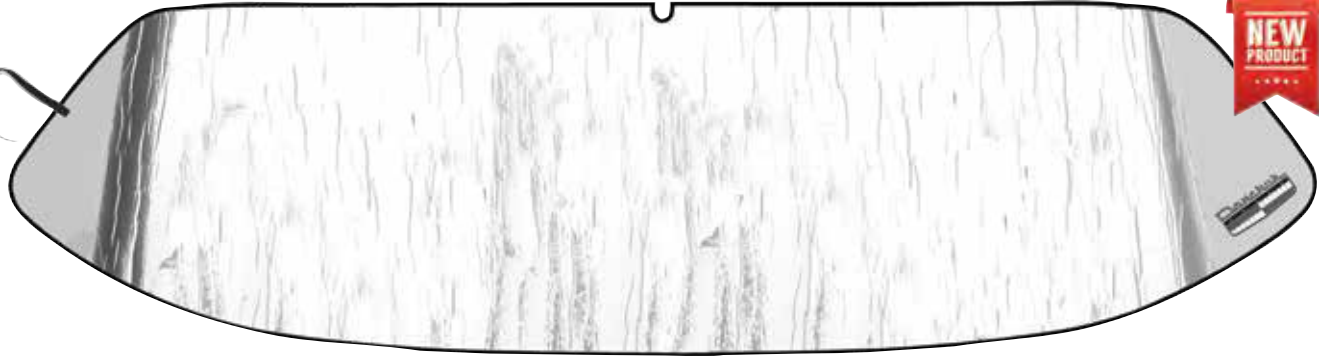

MISCELLANEOUS

CUSTOM TRI-FIVE WINDSHIELD SHADES

1955-56	#19404.....	\$39.95/ea.
1957.....	#19405.....	\$39.95/ea.



TOM MCEWEN FUNNY CAR TRAILER HITCH COVER

Whether your a '57 Chevy fan, a funny car fan or a Tom McEwen fan, Danchuk offers you this high quality trailer hitch cover that starts with a high resolution image of one of the most famous 57's, then precision cuts it out of 1/4" powdercoated aluminum. The image is embedded and covered with a UV coating to protect it from fading.
 All..... #16524..... \$59.95/ea.



MAGNETIC SIGNS - 5" X 3"

"Look But Please Don't Touch"	#1771.....	\$4.95/ea.
"Look and Enjoy, But Please Don't Touch"	#1772.....	\$4.95/ea.
"You Toucha Dis Machine, I Smasha You Face"	#1773.....	\$7.95/ea.
"Look But Please Don't Touch My Classic . . ."	#1774.....	\$7.95/ea.

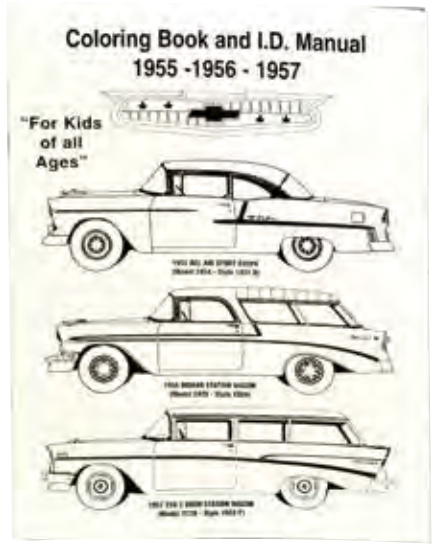

1955-56-57 COLORING BOOK AND I.D. MANUAL

All..... #16998..... \$5.95/ea.



I'D RATHER BE DRIVING MY . . . BUMPER STICKERS

'55 Chevy	#332A.....	\$2.95/ea.
'56 Chevy	#332B.....	\$2.95/ea.
'57 Chevy	#332C.....	\$2.95/ea.

17. Specifications

This section is probably the most valuable section in the catalog for the guys restoring a Tri-Five, or just a fan. Here you will find information on how to decipher your VIN tag and Cowl tag; which will tell you where your car was built, what engine and transmission came with it, and if it started life as a Bel Air, 210 or 150 model. You can find what your cars original color scheme was, and what interior came with it. If the dealer made changes, this tag will tell you that as well. You will also find information regarding accessory items that were added when your car was ordered.

You will find a representation of all the body styles; hardtop, convertible, sedan, Nomad or wagon for all three years, as well as what the side trim looked like to help you figure out which model you have.

We have included original power specs on the engines that were available, engine ID Codes that tell you which plant manufactured it and when. There are numbers for axle ID Tags, casting numbers for heads, intakes, distributors, radiators and more, as well as a schematic showing you where to find the ID Tag locations on the body, engine, trans, rear axle and where the VIN Number is stamped on the frame.

We round out the section with a breakdown of the interior and exterior color codes, and we threw in some color samples just for good measure. Everything you want to know about your car is probably right here in the Original Specifications Section.

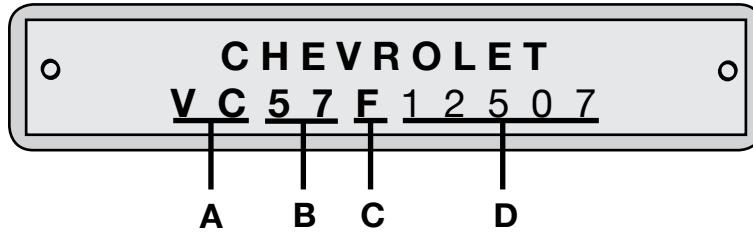

THE VIN TAG

The stainless steel VIN tag is welded to the driver's door pillar post. Coded into this tag is the following information:

A. This part of the code may be either one or two letters. If two, the first letter will always be a "V". This indicates that the car has a V8 engine. The second letter will tell you the model series of the car. For model series identification, see below.

6 Cylinder

- A** 1500 (exc. 1508)
- B** 2100
- C** 2400
- D** 1508
- E** 2900 (1955)

8 Cylinder

- VA** 1500 (exc. 1508)
- VB** 2100
- VC** 2400
- VD** 1508
- VE** 2900 (1955)

B. These two numbers indicate the year of the car.

C. This is one letter only, indicating where the car was assembled.

- | | |
|----------------------------|----------------------------|
| A - Atlanta, GA | L - Los Angeles, CA |
| B - Baltimore, MD | N - Norwood, OH |
| F - Flint, MI | O - Oakland, CA |
| J - Janesville, WI | S - St. Louis, MO |
| K - Kansas City, MO | T - Tarrytown, NY |

D. The last sequence of numbers is the serial number of the car. At a given body plant this number was not duplicated. The 1955 and 1956 starting number was 1001 at each assembly plant. The 1957 starting number was 100001 at each assembly plant. Corvettes (2900 series) were numbered separately.

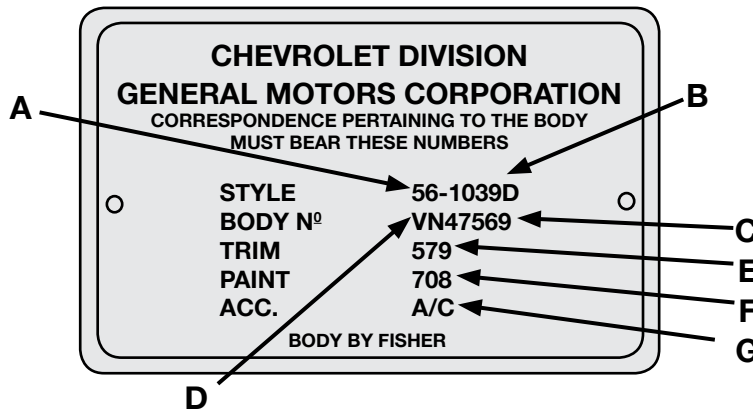

THE COWL TAG

This aluminum plate is riveted to the cowl. On the 1955-56 cars it is found on the top of the firewall on the passenger side, except on 1955-56 air conditioned cars. The cowl tag on A/C cars can be found on the driver's side. The 1957 cowl tag can be found on the firewall in the engine compartment. There were two positions for the 1957 tag. For the first design, it is on the cowl toe panel; for the second design, it is located under the heater control valve.

A. These two numbers indicate the year of the car.

B. This number was assigned by the Fisher Body plant and gives information for determining the model and series. See page 714 for table or refer to Body Styles on pages 711-713.

C. This sequence of numbers represents the numerical production at the Fisher Body plant. This is a non-duplicating number, beginning with '1', for the first body produced.

D. This is either one or two letters, indicating which Fisher Body plant produced that body.

- | | |
|----------------------------|--------------------------|
| A - Atlanta, GA | M - Baltimore, MD |
| CL - Cleveland, OH | N - Norwood, OH |
| F - Flint, MI | O - Oakland, CA |
| J - Janesville, WI | S - St. Louis, MO |
| K - Kansas City, MO | T - Tarrytown, NY |
| L - Lansing, MI | VN - Van Nuys, CA |

E. This set of three numbers represents the interior combination of fabric type and color. Refer to the Interior combinations charts beginning on page 716 for a complete list of the combinations available in 1955, 1956 and 1957. This three digit number appears in the first column of each chart.

F. This set of three numbers, sometimes followed by a letter, represents the exterior paint combination. Please refer to

1955 BODY STYLES AND MODEL NUMBERS

BEL AIR BODY STYLES

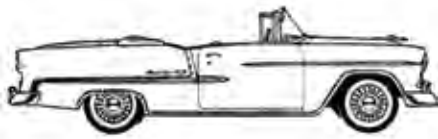

'55 BEL AIR CONVERTIBLE [1067D](#)

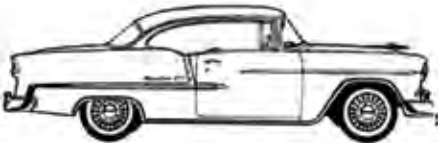

'55 BEL AIR 2-DOOR HARDTOP [1037D](#)

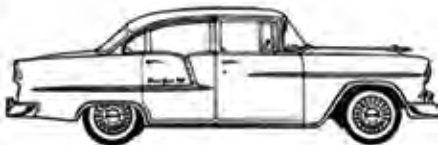

'55 BEL AIR 4-DOOR SEDAN [1019D](#)

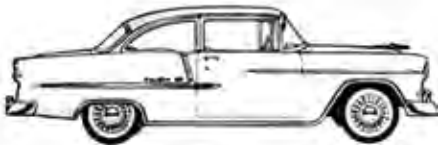

'55 BEL AIR 2-DOOR SEDAN [1011D](#)



'55 BEL AIR 4-DOOR WAGON [1062DF](#)

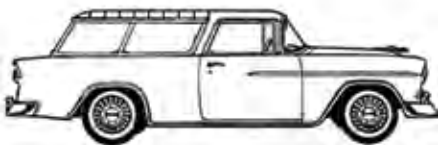

'55 BEL AIR NOMAD
2-DOOR WAGON [1064DF](#)

TWO-TEN BODY STYLES

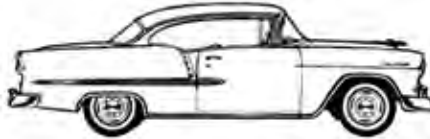

'55 TWO-TEN 2-DOOR HARDTOP [1037](#)

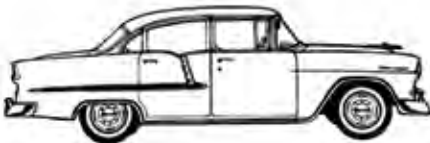

'55 TWO-TEN 4-DOOR SEDAN [1019](#)

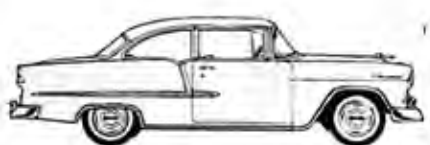

'55 TWO-TEN 2-DOOR SEDAN [1011](#)
DEL RAY [1011A](#)



'55 TWO-TEN 4-DOOR WAGON [1062F](#)

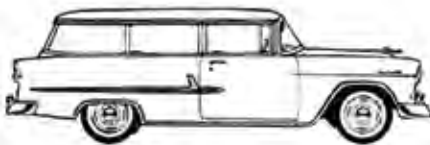

'55 TWO-TEN 2-DOOR WAGON [1063F](#)

ONE-FIFTY BODY STYLES

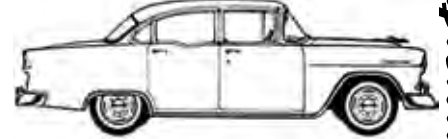

'55 ONE-FIFTY 4-DOOR SEDAN [1219](#)

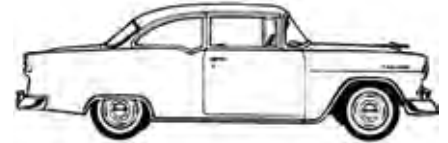

'55 ONE-FIFTY 2-DOOR SEDAN [1211](#)
& UTILITY SEDAN [1211B](#)



'55 ONE-FIFTY 2-DOOR WAGON [1263F](#)

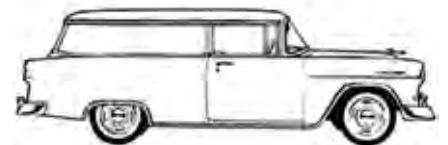

'55 ONE-FIFTY 2-DOOR
SEDAN DELIVERY [1271](#)

COWL TAG INFORMATION CONTINUED FROM PREVIOUS PAGE

the Paint Combination and Two-Tone Color Combination charts starting on page 718 for a complete list of the paint combinations available. This three digit number appears in the first column of each chart.

G. To the right of "ACC" are stamped letters that indicate the accessories installed at the factory. Not all accessories were indicated on the cowl tag, but major items, such as air conditioning, were. A partial list of the factory installed accessory codes includes:

- AC - Air Conditioning
- CP - Padded Dash
- EZI - Tinted Glass
- SA - Power Seats (Only)
- WA - Power Windows (Only)
- WS - Power Window and Seats

1956 BODY STYLES AND MODEL NUMBERS

BEL AIR BODY STYLES

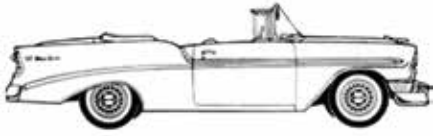

'56 BEL AIR CONVERTIBLE [1067D](#)

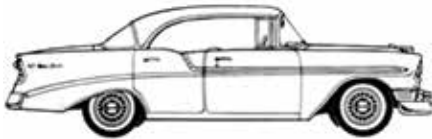

'56 BEL AIR 4-DOOR HARDTOP [1039D](#)

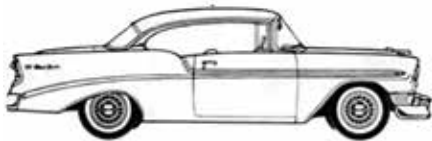

'56 BEL AIR 2-DOOR HARDTOP [1037D](#)

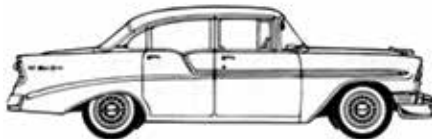

'56 BEL AIR 4-DOOR SEDAN [1019D](#)

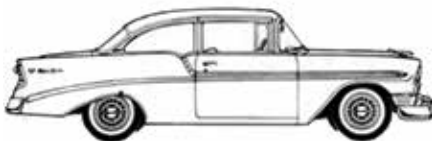

'56 BEL AIR 2-DOOR SEDAN [1011D](#)

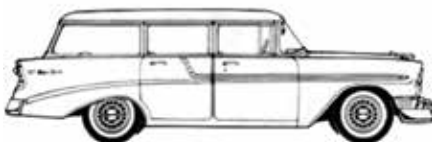

'56 BEL AIR 4-DOOR WAGON [1062DF](#)

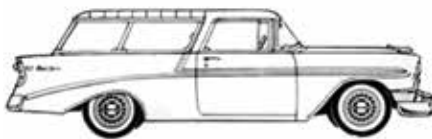

'56 BEL AIR NOMAD
2-DOOR WAGON [1064DF](#)

TWO-TEN BODY STYLES

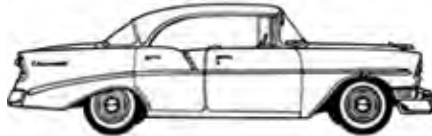

'56 TWO-TEN 4-DOOR HARDTOP [1039](#)

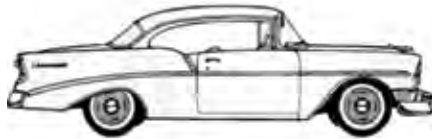

'56 TWO-TEN 2-DOOR HARDTOP [1037](#)

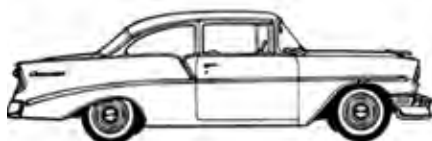

'56 TWO-TEN 2-DOOR SEDAN [1011](#)
DEL RAY [1011A](#)

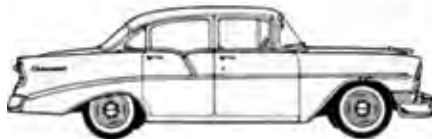

'56 TWO-TEN 4-DOOR SEDAN [1019](#)



'56 TWO-TEN 4-DOOR WAGON [1064DF](#)
6-PASS - [1062F](#) OR 9-PASS [1062DF](#)



'56 TWO-TEN 2-DOOR WAGON [1063F](#)

ONE-FIFTY BODY STYLES

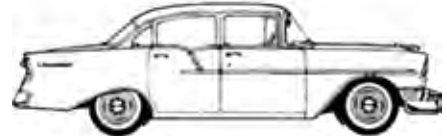

'56 ONE-FIFTY 4-DOOR SEDAN [1219](#)

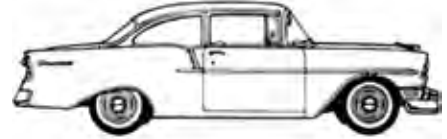

'56 ONE-FIFTY 2-DOOR SEDAN [1211](#)
& UTILITY SEDAN [1211B](#)

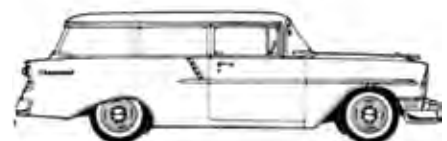

'56 ONE-FIFTY 2-DOOR WAGON [1263F](#)

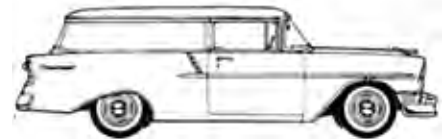

'56 ONE-FIFTY 2-DOOR
SEDAN DELIVERY [1271](#)

1957 BODY STYLES AND MODEL NUMBERS

BEL AIR BODY STYLES

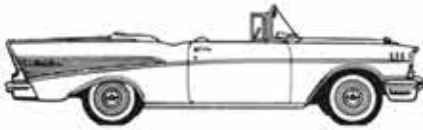

'57 BEL AIR CONVERTIBLE [1067D](#)

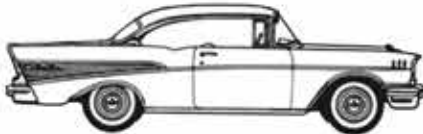

'57 BEL AIR 2-DOOR HARDTOP [1037D](#)

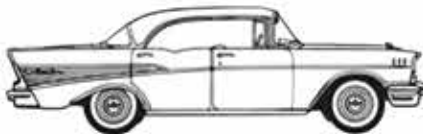

'57 BEL AIR 4-DOOR HARDTOP [1039D](#)

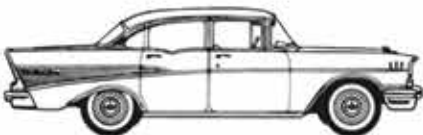

'57 BEL AIR 4-DOOR SEDAN [1019D](#)

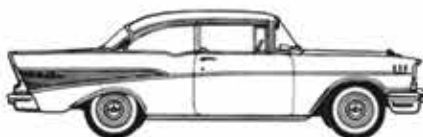

'57 BEL AIR 2-DOOR SEDAN [1011D](#)

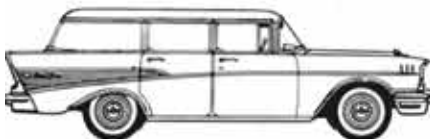

'57 BEL AIR 4-DOOR WAGON [1062DF](#)

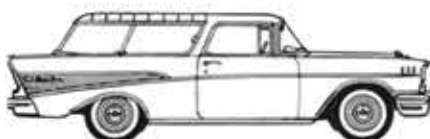

'57 BEL AIR NOMAD WAGON [1064DF](#)

TWO-TEN BODY STYLES

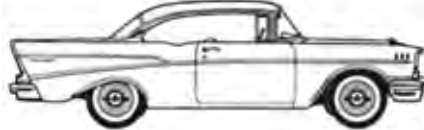

'57 TWO-TEN 2-DOOR HARDTOP [1037](#)



'57 TWO-TEN 4-DOOR HARDTOP [1039](#)

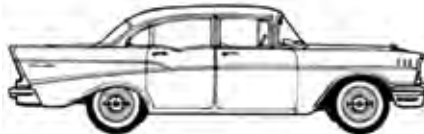

'57 TWO-TEN 4-DOOR SEDAN [1019](#)



'57 TWO-TEN 2-DOOR SEDAN [1011](#)
DEL RAY [1011A](#)



'57 TWO-TEN 4-DOOR WAGON
6-PASS -[1062F](#) OR 9-PASS [1062DF](#)

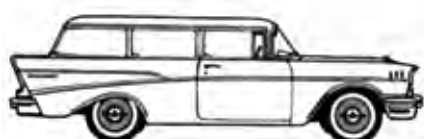

'57 TWO-TEN 2-DOOR WAGON [1063F](#)

ONE-FIFTY BODY STYLES



'57 ONE-FIFTY 4-DOOR SEDAN [1219](#)

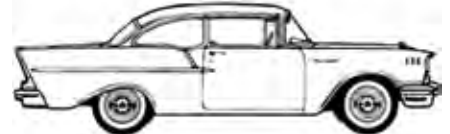

'57 ONE-FIFTY 2-DOOR SEDAN [1211](#)
& UTILITY SEDAN [1211B](#)

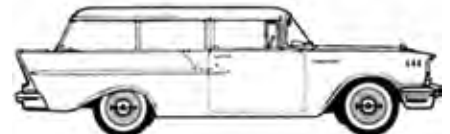

'57 ONE-FIFTY 2-DOOR WAGON [1263F](#)

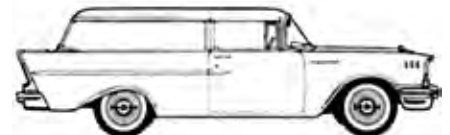

'57 ONE-FIFTY 2-DOOR
SEDAN DELIVERY [1271](#)

1955 ENGINE DATA AND POWER TEAMS

Engine	Models	CID	Comp. Ratio	Bore	Stroke	Gross Horsepower	Net Horsepower	Fuel System	Transmission
Blue Flame 123 6 Cyl.	Passenger	235	7.5	3-9/16"	3-15/16"	123 @ 3800 RPM	109 @ 3600 RPM	Single Barrel	3-Speed Overdrive
Blue Flame 136 6 Cyl.	Passenger	235	7.5	3-9/16"	3-15/16"	136 @ 4200 RPM	121 @ 3800 RPM	Single Barrel	Powerglide
Turbo Fire V8	Passenger	265	8.0	3-3/4"	3"	162 @ 4400 RPM	137 @ 4000 RPM	Two Barrel	3-Speed OD or PG
Turbo Fire V8	Passenger	265	8.0	3-3/4"	3"	180 @ 4600 RPM	137 @ 4200 RPM	Four Barrel	3-Speed OD or PG

1956 ENGINE DATA AND POWER TEAMS

Engine	Models	CID	Comp. Ratio	Bore	Stroke	Gross Horsepower	Net Horsepower	Fuel System	Transmission
Blue Flame 140 6 Cyl.	Passenger	235	8.0	3-9/16"	3-15/16"	140 @ 4200 RPM	125 @ 4000 RPM	Single Barrel	3-Speed OD or PG
Turbo Fire 162 V8	Passenger	265	8.0	3-3/4"	3"	162 @ 4400 RPM	137 @ 4000 RPM	Two Barrel	3-Speed OD
Turbo Fire 170 V8	Passenger	265	8.0	3-3/4"	3"	170 @ 4400 RPM	141 @ 4000 RPM	Two Barrel	Powerglide
Turbo Fire 205 V8	Passenger	265	8.0	3-3/4"	3"	205 @ 4600 RPM	170 @ 4200 RPM	Four Barrel	3-Speed OD or PG
Turbo Fire 225 V8	Passenger	265	9.25	3-3/4"	3"	225 @ 5200 RPM	225 @ 4800 RPM	Dual Four Barrel	3-Speed OD or PG

1957 ENGINE DATA AND POWER TEAMS

Engine	Models	CID	Comp. Ratio	Bore	Stroke	Gross Horsepower	Net Horsepower	Fuel System	Transmission
Blue Flame 140 6 Cyl.	Passenger	235	8.0	3-9/16"	3-15/16"	140 @ 4200 RPM	125 @ 4000 RPM	Single Barrel	3-Speed OD or PG
Turbo Fire 265 V8	Passenger	265	8.0	3-3/4"	3"	162 @ 4400 RPM	137 @ 4000 RPM	Two Barrel	3-Speed Overdrive
Turbo Fire 283 V8	Passenger	283	8.5	3-7/8"	3"	185 @ 4600 RPM	150 @ 4200 RPM	Two Barrel	Powerglide or Turboglide
Super Turbo Fire 283 V8	Passenger	283	9.5	3-7/8"	3"	220 @ 4800 RPM	190 @ 4600 RPM	Four Barrel	3-Speed OD/P.G./G.
Maximum Performance V8*	Passenger	283	9.5	3-7/8"	3"	245 @ 5000 RPM	215 @ 4800 RPM	Dual Four Barrel	3-Speed Close Ratio/P.G. /T.G.
Maximum Performance V8*	Passenger	283	9.5	3-7/8"	3"	250 @ 5000 RPM	225 @ 4800 RPM	Fuel Injection	3-Speed Close Ratio/P.G. /T.G.
Maximum Performance V8*	Passenger	283	9.5	3-7/8"	3"	270 @ 6000 RPM	230 @ 6000 RPM	Dual Four Barrel	3-Speed Close Ratio
Maximum Performance V8*	Passenger	283	10.5	3-7/8"	3"	283 @ 6200 RPM	240 @ 5600 RPM	Fuel Injection	3-Speed Close Ratio

* Maximum performance engines have a special high-performance camshaft, high-speed valve system, and mechanical lifters. All other engines have hydraulic valve lifters.

1955-57 MODEL SERIES

Series #	Model#	Description	Year	Series #	Model#	Description	Year	Series #	Model#	Description	Year
Series A, Model One-Fifty				Series B, Model Two-Ten				Series C, Model Bel Air			
1502	1211	2 Dr. Sedan	1955-57	2102	1011	2 Dr Sedan	1955-57	2402	1011D	2 Dr Sedan	1955-57
1503	1219	4 Dr. Sedan	1955-57	2103	1019	4 Dr Sedan	1955-57	2403	1019D	4 Dr Sedan	1955-57
1512	1211B	Utility Sedan	1955-57	2109	1062F	4 Dr 6 Psngr Wgn	1955-57	2409	1062DF	4 Dr 6 Psngr Wagon	1955, 57
1529	1263F	2 Dr., 6 Psngr Wgn	1955-57	2113	1039	4 Dr Ht Sport Sedan	1955-57	2413	1039D	4 Dr Ht Sport Sedan	1956-57
				2119	1062FC	4 Dr 9 Psngr Wagon	1956-57	2419	1062DF	4 Dr 9 Psngr Wagon	1956
				2124	1011A	Club Coupe (Del Ray)	1955-57	2429	1064DF	Nomad	1955-57
				2129	1063F	2 Dr 6 Psngr Wagon	1955-57	2434	1067D/or DTX	Convertible	1955-57
				2154	1037	2 Dr Sport Coupe	1955-57	2454	1037D	2 Dr Ht Sport Coupe	1955-57
								Series D, Model One-Fifty			
				1508	1271	Sedan Delivery	1955-57				

EXCEPTIONS AND ABBREVIATIONS:

Please see page 684 for Interior Combination chart exceptions. See page 686 for the table listing all paint color abbreviations used in the Paint Combination and Two-Tone Color Combination charts.

1955-57 ENGINE IDENTIFICATION CODES

1955 Engines

Engine Source Designation:
F - Flint, T - Tonawanda
Model Year Designation: 55
Example: 0001065F55Y
This engine is the 65th 2400 series 6 cylinder built at the Flint plant, designed to be used with a powerglide transmission.

1956 Engines

Engine Source Designation:
F - Flint, T - Tonawanda
Model Year Designation: 56
Example: 0001050T56GC
This engine is the 50th 2100 series 8 cylinder built at the Tonawanda plant, designed to be used with an overdrive equipped transmission.

1957 Engines

Engine Source Designation:
F - Flint, T - Tonawanda, C - Canada
Model Year Designation: 57
Example: F301A
The 3 or 4-digit number following the letter designates the day and month the engine was produced. Example shown produced March 1st. If it had been built Oct. 19, it would read F1019A.

IDENTIFICATION TAG LOCATIONS

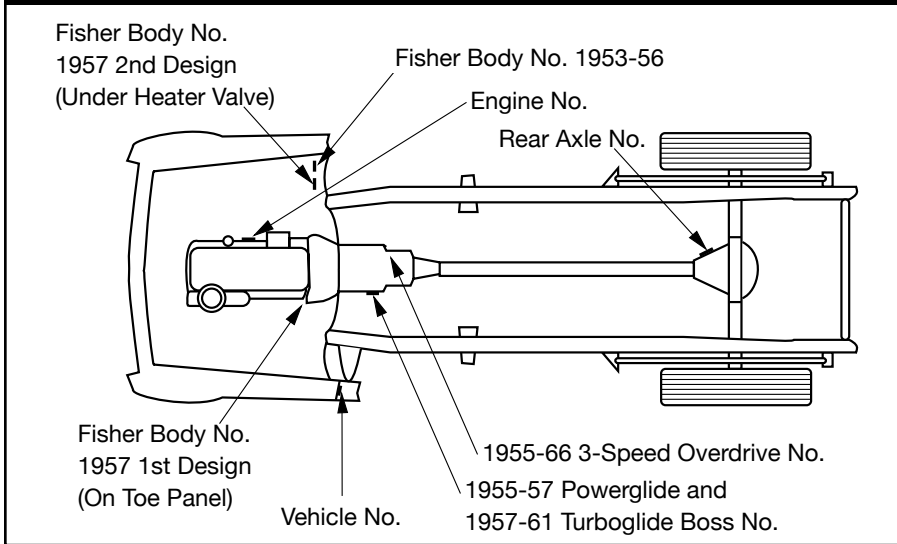

55-57 CASTING & TAG NUMBERS

Year	Description	Number
Distributors (Cont.)		
1957	V8 F.I. (Early no. was 1110889)	1110905
1957	V8 w/ Single Point Ign, Standard Cam	1110906
1957	V8 w/ Tach Drive	1110908
Radiators		
1955-566 Cyl. w/ Standard Transmission		3133042
1955-566 Cyl. w/ Automatic Transmission		3133043
1957	6 Cyl. w/ Standard Transmission	3136569
1957	6 Cyl. w/ Automatic Transmission	3136570
1955-57V8 w/ Std. Trans. (also 3136157, 31360456)		3133044
1955-57V8 w/ Auto. Trans. (also 3137077)		3136158
Generators		
1955-576 Cyl. w/o Power Steering		1100326
1955	V8 w/o Power Steering, 30 Amp.	1102005
1955	V8 w/ Power Steering, 30 Amp.	1102020
1956-57V8 w/o Power Steering, 25 Amp.		1100321
1956-57V8 w/o Power Steering, 30 Amp.		1102042
1956-57V8 w/ Power Steering, 30 Amp.		1102041
1957	V8 w/o Pwr. Str. w/ Air Cond., 40 Amp.	1106981
Starters		
1955-566 Cyl.		1107644
1957	6 Cyl.	1107652
1955-56V8		1107627
1957	V8	1107664
1957	V8 w/ Turboglide	1107694
Exhaust Manifolds		
1955-576 Cyl.		3835587
1955	V8 Passenger Side	3704792
1955	V8 Driver Side	3704791
1956	V8 Passenger Side	3836968
1956	V8 Driver Side	3837069
1956	V8 Dual 4BC, Passenger Side	3731558
1956	V8 Dual 4BC, Driver Side	3731557
1957	V8 Passenger Side	3733978
1957	V8 Driver Side	3733975
Water Pumps		
1955-56V8		3704911
1957	V8	3736493
1955-576 Cyl., Second Design		3741033
Harmonic Balancers		
1955-57V8		3836196
1955-576 Cyl.		3836160
Carburetors		
1955-576 Cyl., 1BC Carter		2008
1955-576 Cyl., 1BC Carter		2046
1955-576 Cyl., 1BC Carter		2101
1955	6 Cyl., 1BC Rochester	7007180
1955	6 Cyl., 1BC Rochester	7007181
1955	6 Cyl., 1BC Rochester	7009254

ENGINE TAG LOCATION

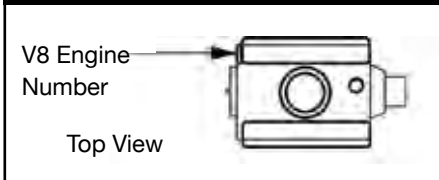

55-57 CASTING & TAG NUMBERS

Year	Description	Number
Cylinder Heads		
1955-576 Cyl.		3836848
1955	All V8 Engines	3703523
1955	Some 1955 2BC Engines	3837064
1956	V8 2BC	3837064
1956	V8 4BC	3725306
1956	V8 Dual 4BC	3731762
1957	V8 2BC	3731554
1957	V8 Dual 4BC, Fuel Injection	3731539
1957	V8 Dual 4BC, Fuel Injection	3740997
Intake Manifold		
1955	6 Cyl.	3835590
1956-576 Cyl.		3838822
1955	V8 2BC	3704790
1955	V8 4BC	3711348
1956	V8 2BC	3735444
1956	V8 4BC	3737109
1956	V8 Dual 4BC	3731394
1957	V8 2BC	3732880
1957	V8 4BC (Early number was 3731398)	3746829
1957	V8 Dual 4BC	3739653
1957	Fuel Injection	3741193
Distributors		
1955-57All		1112403
1955	V8 w/ Standard Transmission	1110847
1956	V8 w/ Automatic Transmission	1110866
1956	V8 4BC	1110869
1956	V8 Dual 4BC	1110879
1957	V8 2BC	1110874
1957	V8 4BC	1110890
1957	V8 Dual 4BC	1110891

55-58 PSNGR REAR AXLE I.D.

Series	Year	Transmission	Ratio	Detroit	Buffalo
Psng	55-56	3-Speed	3.70:1	AA	BA
Psng	55-56	Powerglide	3.55:1	AB	BB
Psng	55-56	3-Speed O.D.	4.11:1	AC	BC
Psng	1957	3-Speed	3.55:1	AA	BA
Psng	1957	Automatics	3.36:1	AB	BB
Psng	1957	3-Speed O.D.	4.11:1	AC	BC
Psng	1957	3-Spd. w/ Posi.	3.55:1	AK	None
Psng	1957	Auto. w/ Posi.	3.36:1	AM	None
Psng	1957	3-Spd. O.D. w/Posi.	4.11:1	AL	None

None
Axle i.d. is stamped on differential carrier with date of manufacture.

55-57 CASTING & TAG NUMBERS

Year	Description	Number
Engine Block		
1955-57	6 Cyl. w/ Dual Hole Water Pump	3835911
1955-57	6 Cyl. w/ Dual Hole Water Pump	3733949
1955-57	6 Cyl. w/ Dual Hole Water Pump	3833949
1955-57	6 Cyl. w/ Single Hole Water Pump	3739716
1955-57	6 Cyl. w/ Single Hole Water Pump	3836233
1955-57	6 Cyl. w/ Single Hole Water Pump	3837004
1955	V8	3703524
1956	V8	3720991
1957	V8 265, 283	3731548

55-57 CASTING & TAG NUMBERS

Year	Description	Number
Carburetors (Cont.)		
1956	6 Cyl., 1BC Rochester	7009255
1957	6 Cyl., 1BC Rochester	7009656
1957	6 Cyl., 1BC Rochester	7009657
1955-56V8, 2BC Carter (WGD)		2286
1955	V8, 2BC Rochester	7005810
1955	V8, 2BC Rochester	7006825
1955	V8, 2BC Rochester	7008004
1955	V8, 2BC Rochester	7008005
1955	V8, 2BC Rochester	7008387
1956	V8, 2BC Rochester	7008388
1957	V8, 2BC Rochester	7010647
1957	V8, 2BC Rochester	7010648
1957	V8, 2BC Rochester	7011224
1957	V8, 2BC Rochester	7011131
1955	V8, 4BC Carter (WCFB)	2218
1955	V8, 4BC Carter (WCFB)	2351
1956	V8, 4BC Carter (WCFB)	2366
1957	V8, 4BC Carter (WCFB)	2505
1957	V8, 4BC Carter (WCFB)	2555
1955-57V8, Dual 4BC Carter, Front		2419
1955-57V8, Dual 4BC Carter, Front		2613
1955-57V8, Dual 4BC Carter, Front		2626
1955-57V8, Dual 4BC Carter, Front		3181
1955-57V8, Dual 4BC Carter, Front		3182
1955-57V8, Dual 4BC Carter, Rear		2362
1955-57V8, Dual 4BC Carter, Rear		2614
1955-57V8, Dual 4BC Carter, Rear		2627
1956	V8, 4BC Rochester	7008737
1957	V8, 4BC Rochester	7009846
1957	V8, 4BC Rochester	7012126

1955-57 BELL HOUSING CASTING

Year	Description	Number
1955-57V8 w/ Standard Transmission		3704922
1955-56V8 w/ Powerglide		3836142
1957 V8 w/ Powerglide		3733365
1955-576 Cyl. w/ Powerglide		3836601
1955-576 Cyl. w/ Standard Transmission		3739586

1955 ENGINE IDENTIFICATION

Model	Drive Train Configuration	Serial # Suffix
15-21-2400	235 6 Cyl. w/ 3-Speed, Overdrive	Z
Taxi Cab	235 6 Cyl. w/ Heavy Duty Clutch	ZC
15-21-2400	235 6 Cyl. w/ Alum. Cam Gear	ZH
15-21-2400	235 6 Cyl. w/ Alum. Cam Gr., H. D. Cl. ZJ	
15-21-2400	235 6 Cyl. w/ Powerglide	Y
15-21-2400	265 V8 w/ 3-Speed	G

1955 ENGINE IDENTIFICATION

Model	Drive Train Configuration	Serial # Suffix
15-21-2400	265 V8 w/ Overdrive	GC
15-21-2400	265 V8 w/ 3-Speed, Air Conditioning	GF
15-21-2400	265 V8 w/ Overdrive, Air Conditioning	GQ
15-21-2400	265 V8 w/ Heavy Duty Clutch	GJ
15-21-2400	265 V8 w/ Heavy Duty Clutch, A/C	GK
15-21-2400	265 V8 w/ 4BC, 3-Spd., Dual Exhaust	GL
15-21-2400	265 V8 w/ 4BC, 3-Spd., Dual Exh. A/C	GM
15-21-2400	265 V8 w/ 4BC, O.D., Dual Exhaust	GE
15-21-2400	265 V8 w/ 4BC, O.D., A/C, Dual Exhaust	GN
15-21-2400	265 V8 w/ Powerglide	F
15-21-2400	265 V8 w/ 4BC, Powerglide, Dual Exh. FB	
15-21-2400	265 V8 w/ Powerglide, A/C	FC
15-21-2400	265 V8 w/ 4BC, P.G., Dual Exh., A/C	FD
2900	235 6 Cyl. w/ Powerglide	YG
2900	265 V8 w/ Powerglide	FG
2900	265 V8 w/ 3-Speed	GR

1956 ENGINE IDENTIFICATION

Model	Drive Train Configuration	Serial # Suffix
15-21-2400	235 6 Cyl. w/ 3-Speed, Overdrive	Z
15-21-2400	235 6 Cyl. w/ Heavy Duty Clutch	ZC
15-21-2400	235 6 Cyl. w/ Powerglide	Y
15-21-2400	265 V8 w/ 3-Speed	G
15-21-2400	265 V8 w/ Overdrive	GC
15-21-2400	265 V8 w/ 4BC	GL
15-21-2400	265 V8 w/ Dual 4BC	GS
15-21-2400	265 V8 w/ Dual 4BC, Hi-Lift Cam	GT
15-21-2400	265 V8 w/ 4BC, Air Conditioning	GM
15-21-2400	265 V8 w/ Heavy Duty Clutch	GJ
15-21-2400	265 V8 w/ Heavy Duty Clutch, A/C	GK
15-21-2400	265 V8 w/ 4BC, Overdrive	GE
15-21-2400	265 V8 w/ 4BC, Overdrive, A/C	GN
15-21-2400	265 V8 w/ Powerglide	F
15-21-2400	265 V8 w/ 4BC, Powerglide	FB
15-21-2400	265 V8 w/ Dual 4BC, Powerglide	FH
15-21-2400	265 V8 w/ Air Conditioning	FC
15-21-2400	265 V8 w/ 4BC, A/C	FD
2900	265 V8 w/ 3-Speed	GV
2900	265 V8 w/ Dual 4BC, Hi-Lift Cam	GU
2900	265 V8 w/ Dual 4BC	GR
2900	265 V8 w/ Powerglide	FK
2900	265 V8 w/ Dual 4BC, Powerglide	FG

1957 ENGINE IDENTIFICATION

Model	Drive Train Configuration	Serial # Suffix
15-21-2400	235 6 Cyl. w/ 3-Speed, Overdrive	A
15-21-2400	235 6 Cyl. w/ Heavy Duty Clutch	AD
15-21-2400	235 6 Cyl. w/ Powerglide	B
15-21-2400	265 V8 w/ 3-Speed	C

1957 ENGINE IDENTIFICATION

Model	Drive Train Configuration	Serial # Suffix
15-21-2400	265 V8 w/ Overdrive	CD
15-21-2400	265 V8 w/ Heavy Duty Clutch	CE
15-21-2400	283 V8 w/ 4BC	E
15-21-2400	283 V8 w/ Dual 4BC	EA
15-21-2400	283 V8 w/ Dual 4BC w/ Hi-Lift Cam	EB
15-21-2400	283 V8 w/ Fuel Injection	EJ
15-21-2400	283 V8 w/ Fuel Injection, Hi Lift Cam	EK
15-21-2400	283 V8 w/ 4BC, Overdrive	EC
15-21-2400	283 V8 w/ Powerglide	F
15-21-2400	283 V8 w/ Powerglide, A/C	FA
15-21-2400	283 V8 w/ 4BC, Powerglide	FC
15-21-2400	283 V8 w/ Dual 4BC, Powerglide	FD
15-21-2400	283 V8 w/ Fuel Injection, Powerglide	FJ
15-21-2400	283 V8 w/ 4BC, Powerglide, A/C	FE
15-21-2400	283 V8 w/ Turboglide	G
15-21-2400	283 V8 w/ 4BC, Turboglide	GC
15-21-2400	283 V8 w/ Dual 4BC, Turboglide	GD
15-21-2400	283 V8 w/ Fuel Injection, Turboglide	GF
2900	283 V8 w/ 4BC, 3-Speed	EF
2900	283 V8 w/ Dual 4BC, Hi-Lift Cam	EG
2900	283 V8 w/ Dual 4BC	EH
2900	283 V8 w/ F.I., Hi-Lift Cam, A/C	EL
2900	283 V8 w/ Fuel Injection, Hi-Lift Cam	EN
2900	283 V8 w/ Fuel Injection	EM
2900	283 V8 w/ Dual 4BC, Powerglide	FG
2900	283 V8 w/ Powerglide	FH
2900	283 V8 w/ F.I., Powerglide	FK

INTERIOR COMBINATIONS

This information pertains to the upholstery used on seats, door panels, headliners and convertible tops. The three-digit number in the first column of each chart corresponds to the "Trim" number found on the cowl tag.

1955 INTERIOR COMBINATIONS

#	Material Combination	Models
500	Light Gray Pattern Cloth (exc. Wgn., Sed. Del.)	1200
547	Light Gray Pattern Cloth w/ Black Vinyl	1211
506	Beige Vinyl w/ Light Blue Vinyl	1011A
507	Beige Vinyl w/ Light Green Vinyl	1011A
508	Ivory Vinyl w/ Black Vinyl	1011A
503	Dk Blue Gabardine w/Lt. Blue Pat. Cloth	1011D-19-37
504	Dk Green Gabardine w/Lt. Grn. Pat. Cloth	1011D-19-37
505	Dk Brown Gabardine w/Lt. Tan Pat. Cloth	1011D-19-37
509	Lt. Blue Vinyl w/ Dk. Blue Pattern Cloth	1101D-19D
510	Lt. Green Vinyl w/ Dk Green Pat. Cloth	1101D-19D
511	Beige Vinyl w/ Dark Brown Pattern Cloth	1101D-19D

1955 INTERIOR COMBINATIONS

#	Material Combination	Models
513	Ivory Vinyl w/ Turquoise Pattern Cloth	1101D-19D
531	Coral Vinyl w/ Gray Pattern Cloth	1011D-19D
549	Ivory Vinyl w/ Dark Gray Pattern Cloth	1011D-19D
525	Beige Vinyl w/ Red Vinyl	1067D/DTX
526	Light Green Vinyl w/ Dark Green Vinyl	1067D/DTX
527	Light Blue Vinyl w/ Dark Blue Vinyl	1067D/DTX
528	Beige Vinyl w/ Brown Vinyl	1067D/DTX
533	Coral Vinyl w/ Dark Gray Vinyl	1067D/DTX
537	Ivory Vinyl w/ Turquoise Vinyl	1067D/DTX
551	Ivory Vinyl w/ Dark Gray Vinyl	1067D/DTX
519	Light Blue Vinyl w/ Straw Pattern Cloth	1037D
520	Light Green Vinyl w/ Straw Pattern Cloth	1037D
521	Red Vinyl w/ Straw Pattern Cloth	1037D
522	Turquoise Vinyl w/ Straw Pattern Cloth	1037D
532	Coral Vinyl w/ Gray Pattern Cloth	1037D
550	Ivory Vinyl w/ Gray Pattern Cloth	1037D
514	Beige Vinyl w/ Blue Ribbed Vinyl	1062F-63F
515	Lt Green Vinyl w/ Dk Green Ribbed Vinyl	1062F-63F
516	Beige Vinyl w/ Brown Ribbed Vinyl	1062F-63F
517	Light Beige Vinyl w/ Straw Pattern Cloth	1062DF
518	Blue Vinyl w/ Straw Pattern Cloth	1062DF
502	Brown Vinyl w/ Straw Textured Vinyl	1263F
524	Light Green Vinyl w/ Dark Green Tex. Vinyl	1263F
501	Brown Vinyl w/ Straw Pattern Cloth	1271
541	Beige Vinyl w/ Green Waffle Pattern Vinyl	1064DF
542	Beige Vinyl w/ Blue Waffle Pattern Vinyl	1064DF
543	Beige Vinyl w/ Brown Waffle Pattern Vinyl	1064DF
544	Beige Vinyl w/ Red Waffle Pattern Vinyl	1064DF
545	Ivory Vinyl w/ Turq. Waffle Pattern Vinyl	1064DF
546	Coral Vinyl w/ Gray Waffle Pattern Vinyl	1064DF
552	Ivory Vinyl w/ Gray Waffle Pattern Vinyl	1064DF

1956 INTERIOR COMBINATIONS

#	Material Combination	Models
560	Please see exception notes.	1200
567	Ivory Vinyl w/ Black Vinyl	1011A
568	Ivory Vinyl w/ Green Vinyl	1011A
569	Ivory Vinyl w/ Turquoise Vinyl	1011A
564	Starfrost Vinyl w/ Char. Gray Patt. Cloth	1011-19-37-39
565	Starfrost Vinyl w/ Green Pattern Cloth	1011-19-37-39
566	Starfrost Vinyl w/ Blue Pattern Cloth	1011-19-37-39
573	Ivory Vinyl w/ Charcoal Pattern Cloth	1011D-19D
574	Lt Green Vinyl w/ Dark Green Pat. Cloth	1011D-19D
575	Lt Blue Vinyl w/ Dark Blue Pattern Cloth	1011D-19D
577	Lt Turq. Vinyl w/ Dark Turq. Pat. Cloth	1011D-19D
578	Yellow Vinyl w/ Charcoal Pattern Cloth	1011D-19D
617	Tan Vinyl w/ Copper Pattern Cloth	1011D-19D
626	Cream Vinyl w/ Charcoal Pattern Cloth	1011D-19D

1956 INTERIOR COMBINATIONS

#	Material Combination	Models
602	Ivory Vinyl w/ Charcoal Pattern Vinyl	1067D/DTX
603	Ivory Vinyl w/ Dk Turquoise Pattern Vinyl	1067D/DTX
604	Yellow Vinyl w/ Charcoal Gray Patt Vinyl	1067D/DTX
605	Ivory Vinyl w/ Red Pattern Vinyl	1067D/DTX
606	Lt Green Vinyl w/ Dk Green Pattern Vinyl	1067D/DTX
607	Lt Blue Vinyl w/ Dk Blue Pattern Vinyl	1067D/DTX
621	Tan Vinyl w/ Copper Pattern Vinyl	1067D/DTX
631	Cream Vinyl w/ Charcoal Pattern Vinyl	1067D/DTX
579	Ivory Vinyl w/ Charcoal Gray Patt Cloth	1037D-39D
610	Ivory Vinyl w/ Charcoal Pattern Cloth	1062DF
629	Please see exception notes.	1062DF
630	Cream Vinyl w/Char/Yellow Patt Cloth	1062DF
611	Ivory Vinyl w/ Charcoal Pattern Cloth	1064
632	Cream Vinyl w/Charcoal/Yellow Patt Cloth	1064
633	Red Vinyl w/ Red Taupe Pattern Cloth	1064
580	Lt Green Vinyl w/ Med. Green Patt Cloth	1037D-39D
590	Lt Green Vinyl w/ Med. Green Patt Cloth	1064
581	Lt Blue Vinyl w/ Med. Blue Pattern Cloth	1037D-39D
591	Lt Blue Vinyl w/ Light Blue Pattern Cloth	1064
627	Cream Vinyl w/ Char. Yellow Patt Cloth	1037D-39D
628	Please see exception notes.	1039D
593	Red Vinyl w/ Red Pattern Cloth	1064
584	Lt. Turq. Vinyl w/Med. Turq. Patt Cloth	1037D
587	Lt. Turq. Vinyl w/Med. Turq. Patt Cloth	1062DF
594	Lt. Turq. Vinyl w/Med. Turq. Patt Cloth	1064
585	Yellow Vinyl w/ Charcoal Pattern Cloth	1037D-39D
588	Yellow Vinyl w/ Charcoal Pattern Cloth	1062DF
595	Yellow Vinyl w/ Charcoal Pattern Cloth	1064
618	Copper Vinyl w/ Tan Pattern Cloth	1037D-39D
619	Copper Vinyl w/ Tan Pattern Cloth	1062DF
620	Copper Vinyl w/ Tan Pattern Cloth	1064
570	Starfrost Vinyl w/Dk Green Patt Vinyl	1062F-62FC-63F
572	Starfrost Vinyl w/Dk Turq. Patt Vinyl	1062F-62FC-63F
609	Starfrost Vinyl w/Char. Gray Patt Vinyl	1062F-62FC-63F
562	Gold Striped Vinyl w/ Green Vinyl	1263F
616	Gold Striped Vinyl w/Charcoal Gray Vinyl	1263F
615	Gold Striped Vinyl w/Charcoal Gray Vinyl	1271

EXCEPTION NOTES FOR 1956 INTERIOR COMBINATIONS

The chart below lists the exceptions to the data found in the 1956 Interior Combination charts.

1956 INTERIOR COMBIN. EXCEPTIONS

#	Material Combination	Models
560	Beige or Gold Vinyl w/ Gold Dot Black Cloth (Exc. Station Wagon & Sedan Delivery)	1200
628	Red Vinyl w/ Red Taupe Pattern Cloth (Replaces 583)	1039D
629	Red Vinyl w/ Red Taupe Pattern Cloth (Replaces 586)	1062DF

1957 INTERIOR COMBINATIONS

#	Material Combination	Models
650	Black Vinyl w/Black & Gray Patt Cloth	1211-11B-1219
651	Black Vinyl w/Black & Gray Patt Vinyl	1271
652	Black Vinyl w/Black & Gray Patt Vinyl	1263F
653	Med. Green Vinyl w/Green/Gray Pat. Vinyl	1263F
654	Ivory Vinyl w/ Charcoal Pattern Cloth	1011-19-37-39
655	Lt. Green Vinyl w/ Med. Green Patt Cloth	1011-19-37-39
656	Light Blue Vinyl w/ Med. Blue Patt Cloth	1011-19-37-39
657	Ivory Vinyl w/ Charcoal Pattern Vinyl	1011A
658	Lt. Green Vinyl w/ Med. Green Patt Vinyl	1011A
659	Copper Vinyl w/ Beige Pattern Vinyl	1011A
660	Ivory Vinyl w/ Charcoal Pattern Vinyl	1062F-63-62FC
661	Lt. Green Vinyl w/ Med. Green Patt Vinyl	1062F-63-62FC
662	Beige Vinyl w/ Copper Pattern Vinyl	1062F-63-62FC
663	Silver Vinyl w/Black & Silver Patt Cloth	1011D-19D
664	Med. Green Vinyl w/Black/Green Pat. Cloth	1011D-19D
665	Med. Blue Vinyl w/ Black/Blue Patt Cloth	1011D-19D
666	Med. Turquoise Vinyl w/Black/Turq. Cloth	1011D-19D
667	Beige Vinyl w/Black & Copper Patt Cloth	1011D-19D
668	Yellow Vinyl w/ Black & Yellow Patt Cloth	1011D-19D
669	Red Vinyl w/ Black & Red Pattern Cloth	1011D-19D
670	Silver Vinyl w/ Black & Silver Patt Cloth	1037D-39D
671	Med. Green Vinyl w/Black/Dk. Green Cloth	1037D-39D
672	Med. Blue Vinyl w/ Black/Dk. Blue Cloth	1037D-39D
673	Med. Turq. Vinyl w/ Black/Turq. Patt Cloth	1037D-39D
674	Beige Vinyl w/ Black & Copper Patt Cloth	1037D-39D
675	Yellow Vinyl w/ Black & Yellow Patt Cloth	1037D-39D
676	Red Vinyl w/ Black & Red Pattern Cloth	1037D-39D
677	Ivory Vinyl w/ Silver Pattern Vinyl	1067D
678	Lt. Green Vinyl w/ Med. Green Patt Vinyl	1067D
679	Lt. Blue Vinyl w/ Med. Blue Pattern Vinyl	1067D
680	Ivory Vinyl w/ Med. Turquoise Patt Vinyl	1067D
681	Beige Vinyl w/ Copper Pattern Vinyl	1067D
682	Yellow Vinyl w/ Silver Pattern Vinyl	1067D
683	Red Vinyl w/ Silver Pattern Vinyl	1067D
684	Silver Vinyl w/ Black & Silver Patt Cloth	1062DF
685	Med. Green Vinyl w/Black/Green Pat. Cloth	1062DF
686	Med. Blue Vinyl w/Black/Dk. Blue Pat. Cloth	1062DF
687	Med. Turq. Vinyl w/Black/Dk. Turq. Pat. Cloth	1062DF
688	Beige Vinyl w/Black/Copper Patt Cloth	1062DF
689	Yellow Vinyl w/Black/Yellow Patt Cloth	1062DF
690	Red Vinyl w/ Black/Red Patt Cloth	1062DF
691	Silver Vinyl w/ Black/Silver Patt Cloth	1064DF
692	Med. Grn. Vinyl w/ Black/Dk. Grn. Pat. Cloth	1064DF
693	Med. Blue Vinyl w/ Black & Dk. Blue Pat. Cloth	1064DF
694	Med. Turq. Vinyl w/ Black & Dk. Turq. Cloth	1064DF
695	Beige Vinyl w/ Black & Copper Pattern Cloth	1064DF
696	Yellow Vinyl w/ Black & Yellow Pattern Cloth	1064DF
697	Red Vinyl w/ Black & Red Vinyl Pattern Cloth	1064DF

1955 PAINT COMBINATIONS

#	Model Usage Style Number	Body Color	Duco #	Wheel Color	Dulux #	Wheel Stripe	Duco #
585	1101-11A-19-1211-11B-19-71	Onyx Black	2532247	Onyx Black	505	Argent Silver	2894202
585	1101D-19D-37D-67D	Onyx Black	2532247	Onyx Black	505	None	None
586	1011-11A-19-1200 Series	Sea Mist Green	25357950	Sea Mist Green	670	Onyx Black	2532247
586	1011D-19D-67D	Sea Mist Green	25357950	Sea Mist Green	670	None	None
587	1011-11A-19-62F-63F-1200	Neptune Green	28157951	Neptune Green	671	Argent Silver	2894202
587	1011-19D-37D-62DF	Neptune Green	28157951	Neptune Green	671	None	None
588	1011-11A-19-1211-11B-19-71	Skyline Blue	25358001	Skyline Blue	680	Onyx Black	2532247
588	1011D-19-D-67D	Skyline Blue	25358001	Skyline Blue	680	None	None
589	1011-11A-19-62F-63F-1211-11B-19-71	Glacier Blue	28157921	Glacier Blue	676	Argent Silver	2894202
589	1011-19D-37D-62DF	Glacier Blue	28157921	Glacier Blue	676	None	None
590	1011-19-1211-11B-19-71	Copper Maroon	28158099	Copper Maroon	678	Argent Silver	2894202
590	1011D-19D	Copper Maroon	28158099	Copper Maroon	678	None	None
591	1011-19-62F-63F-1211-11B-19	Shoreline Beige	25357602	Shoreline Biege	647	Onyx Black	2532247
591	Bel Air	Shoreline Beige	25357602	Shoreline Biege	647	None	None
592	1011-19-62F-63F-1211-11B-19-63F	Autumn Bronze	28158009	Autumn Bronze	672	Argent Silver	2894202
592	1067D	Autumn Bronze	28158009	Autumn Bronze	672	None	None
593	1011-11A-19-1211-11B-19-71	India Ivory	25358458	India Ivory	689	Onyx Black	2532247
593	1011D-19D	India Ivory	25358458	India Ivory	689	None	None
594	1011-19-1211-11B-19-71	Shadow Gray	28657631	Shadow Gray	654	Argent Silver	2894202
594	1011D-19D	Shadow Gray	28657631	Shadow Gray	654	None	None
596	Convertible	Gypsy Red	25357953	Gypsy Red	673	None	None
598	1062DF-67D	Regal Turquoise	28157955	Regal Turquoise	675	None	None
626	Convertible	Coral	25357990	Coral	679	None	None
630	Sport Coupe	Harvest Gold	25358456	Harvest Gold	698	None	None
683	1011-11A-19-1211-11B-19-71	Cashmere Blue	25358455	Cashmere Blue	699	Onyx Black	2532247
683	1011D-19D	Cashmere Blue	25358455	Cashmere Blue	699	None	None

1956 PAINT COMBINATIONS

Model Usage Style Number	Body Color	Duco #	Wheel Color	Dulux #	Wheel Stripe	Duco #	
687	All Models	Onyx Black	2532247	Onyx Black	505	Argent Silver	2894202
688	150, 210 Series	Pincrest Green	25358897	Pincrest Green	716	Onyx Black	2532247
688	1011D-19D-37D-39D-62DF-67D	Pincrest Green	25358897	Pincrest Green	716	None	None
690	150, 210 Series	Sherwood Green	28659525	Sherwood Green	717	Argent Silver	2894202
690	1101D-19D-37D-39D-67D	Sherwood Green	28659525	Sherwood Green	717	None	None
691	150, 210 Series	Nassau Blue	25358752	Nassau Blue	718	Onyx Black	2532247
691	1011D-19D-37D-39D-62DF-67D	Nassau Blue	25358752	Nassau Blue	718	None	None
692	1011D-19-D-67D	Harbor Blue	28158812	Harbor Blue	719	Argent Silver	2894202
692	1011D-19D-37D-39D-62DF-67D	Harbor Blue	28158812	Harbor Blue	719	None	None
693	1011-11A-19-37-39	Dusk Plum	28159238	Dusk Plum	728	Onyx Black	2532247
693	1011D-19D-37D-39D-62DF-67D	Dusk Plum	28159238	Dusk Plum	728	None	None
694	150, 210 Series	India Ivory	25358458	India Ivory	689	Onyx Black	2532247
694	1011D-19D-37D-39D-62DF-67D	India Ivory	25358458	India Ivory	689	None	None
695	150 Series (exc. 1271), 210 Series	Crocus Yellow	25358763	Crocus Yellow	725	Onyx Black	2532247
695	1011D-19D-37D-39D-62DF-67D	Crocus Yellow	25358763	Crocus Yellow	725	None	None
697	150 Series (exc. 1263DF), 210 Series	Matador Red	25359446	Matador Red	738	Onyx Black	2532247
697	1011D-19D-37D-39D-62DF-67D	Matador Red	25359446	Matador Red	738	None	None
698	210 Series-1211-11B-19	Twilight Turq.	25358920	Twilight Turquoise	723	Argent Silver	2894202
698	1011D-19D-37D-39D-62DF-67D	Twilight Turq.	25358920	Twilight Turquoise	723	None	None

1956 PAINT COMBINATIONS (CONT.)

#	Model Usage Style Number	Body Color	Duco #	Wheel Color	Dulux #	Wheel Stripe	Duco #
749	150 Series (exc. 1271-63F), 210 Series	Tropical Turquoise	25359787	Tropical Turquoise	757	Argent Silver	2894202
749	Bel Air Series (exc. 1064DF)	Tropical Turquoise	25359787	Tropical Turquoise	757	None	None
750	150 Series (exc. 1271)	Calypso Cream	25390209	Calypso Cream	790	Onyx Black	2532247
752	210 Series	Inca Silver	8875603	Inca Silver	759	Onyx Black	2532247
752	Bel Air Series	Inca Silver	8875603	Inca Silver	759	None	None

1957 PAINT COMBINATIONS

#	Model Usage Style Number	Body Color	Duco #	Wheel Color	Dulux #
793	150, 210, Bel Air Series	Onyx Black	2532247	Onyx Black	505
794	150 (exc. 1529), 210, Bel Air Series (exc. 2409-29)	Imperial Ivory	88559931	Imperial Ivory	799
795	150, 210, Bel Air Series	Larkspur Blue	25390114	Larkspur Blue	808
796	150, 210, Bel Air Series	Harbor Blue	28158812	Harbor Blue	719
797	150, 210, Bel Air Series	Surf Green	25390147	Surf Green	807
798	150, 210, Bel Air Series	Highland Green	28659775	Highland Green	822
799	150 (exc. 1508), 210, Bel Air Series	Tropical Turquoise	25359787	Tropical Turquoise	757
800	150 (exc. 1508), 210, Bel Air Series	Colonial Cream	25358094	Colonial Cream	809
801	Bel Air Convertible	Canyon Coral	25390645	Canyon Coral	821
802	150, 210, Bel Air Series	Matador Red	25359446	Matador Red	738
803	Bel Air Convertible	Coronado Yellow	25390620	Coronado Yellow	819
804	210, Bel Air Series	Inca Silver	88756303	Inca Silver	759
805	2124-09-19-29, Bel Air Series	Sierra Gold	28659894	Sierra Gold	742
806	150 (exc. 1508), 210, Bel Air Series	Adobe Beige	25359895	Adobe Beige	760
821	Bel Air Convertible	Dusk Pearl	88790354	Dusk Pearl	812
823	Bel Air Convertible	Laurel Green	28190596	Laurel Green	806

1955 TWO-TONE COMBINATIONS

#	Model Usage Style Number	Upr Body	Duco #	Lwr Body	Duco #	Wheel	Dulux #	Wheel Strp	Duco #
599	1011-19-62F-63F-1211-19-63F	S. Mist Grn.	25357950	Nept. Green	28157951	Nept. Green	671	Argent Silver	2894202
599	1011D-19D	S. Mist Grn.	25357950	Nept. Green	28157951	Nept. Green	671	None	
600	1011-19-1211-19	Skyline Blue	25358001	Glacier Blue	28147921	Glacier Blue	676	Argent Silver	2894202
600	1011D-19D	Skyline Blue	25358001	Glacier Blue	28147921	Glacier Blue	676	None	
601	Sport Coupe	Nept. Green	28157951	Shrln. Beige	25347602	Shrln. Beige	647	None	
602	1011-11A-19-1211-1219	India Ivory	25358458	Skyline Blue	25358001	Skyline Blue	680	Onyx Black	2532247
602	1011D-19D-37D	India Ivory	25358458	Skyline Blue	25358001	Skyline Blue	680	None	
603	1062F-63F	Aut. Bronze	28158009	Shrln. Beige	25357602	Shrln. Beige	647	Onyx Black	2532247
604	1062DF-67D	Nept. Green	28157951	S. Mist Grn.	25357950	S. Mist Grn.	670	None	
605	1011-11A-19	India Ivory	25358458	S. Mist Grn.	25357950	S. Mist Grn.	670	Onyx Black	2532247
606	1011-19-1263F	Shrln. Beige	25357602	Aut. Bronze	28158009	Aut. Bronze	672	Argent Silver	2894202
606	1011D-19D-37D-62DF	Shrln. Beige	25357602	Aut. Bronze	28158009	Aut. Bronze	672	None	
607	1011-11A-19	Glacier Blue	28157921	Shrln. Beige	25357602	Shrln. Beige	647	Onyx Black	2532247
608	1011A	India Ivory	25358458	Onyx Black	2532247	Onyx Black	505	Argent Silver	2894202
608	1011D-19D-37D-67D	India Ivory	25358458	Onyx Black	2532247	Onyx Black	505	None	
610	1062F-63F	Glacier Blue	28157921	Skyline Blue	25358001	Skyline Blue	680	Onyx Black	2532247
610	Convertible	Glacier Blue	28157921	Skyline Blue	25358001	Skyline Blue	680	None	
612	1011D-19D-37D-67D	India Ivory	28358458	Regal Turq.	28157955	Regal Turq.	675	None	
613	1011-19-1211-11B-19	Shrln. Beige	25357602	Nept. Green	28157951	Nept. Green	671	Argent Silver	2894202
613	1011D-19D-37D	Shrln. Beige	25357602	Nept. Green	28157951	Nept. Green	671	None	
614	1011-11A-19-62F-63F-1211-19	Shrln. Beige	25357602	Glacier Blue	28157921	Glacier Blue	676	Argent Silver	2894202

WARNING! Products on these pages may contain chemicals known to the State Of California to cause cancer and/or birth defects or reproductive harm. www.p65warnings.ca.gov

1955 TWO-TONE COMBINATIONS (CONT)

#	Model Usage Style Number	Upr Body	Duco #	Lwr Body	Duco #	Wheel	Dulux #	Wheel Strp	Duco #
599	1011-19-62F-63F-1211-19-63F	S. Mist Grn.	25357950	Nept. Green	28157951	Nept. Green	671	Argent Silver	2894202
614	1011D-19D-37D-62DF	Shrln. Beige	25357602	Glacier Blue	28157921	Glacier Blue	676	None	
615	1037D-62DF-67D	Shrln. Beige	25357602	Gypsy Red	25357953	Gypsy Red	673	None	
617	1011A	India Ivory	25358458	Gypsy Red	25357953	Gypsy Red	673	Argent Silver	2894202
624	1011-19-1211-11B-19	India Ivory	25358458	Shadow Gray	28657631	Shadow Gray	654	Argent Silver	2894202
624	1101D-19D	India Ivory	25358458	Shadow Gray	28657631	Shadow Gray	654	None	
627	1011D-19D-37D-64DF-67D	Shdw Gray	28657631	Coral	25357990	Coral	679	None	
628	1011A	Onyx Black	2532247	India Ivory	25358458	India Ivory	689	Onyx Black	2532247
628	1011D-19D-37D	Onyx Black	2532247	India Ivory	25358458	India Ivory	689	None	
629	Convertible	India Ivory	25358458	Coral	25357990	Coral	679	None	
631	1011A	India Ivory	25358458	Harv. Gold	25358456	Harv. Gold	698	Onyx Black	2532247
631	1011D-19D-37D-67D	India Ivory	25358458	Harv. Gold	25358456	Harv. Gold	698	None	
682	1011-11A-19-62F-63F-1211-19	India Ivory	25358458	Cash. Blue	25358455	Cash. Blue	699	Onyx Black	2532247
682	1011D-19D-37D-62DF-64DF-67D	India Ivory	25358458	Cash. Blue	25358455	Cash. Blue	699	None	
684	1011-19-62F-63F-1263F	India Ivory	25358458	Navajo Tan	28158457	Navajo Tan	700	Onyx Black	2532247
684	1011D-19D-37D-62DF-64DF-67D	India Ivory	25358458	Navajo Tan	28158457	Navajo Tan	700	None	
685	1011D-19D-37D-64DF-67D	India Ivory	25358458	Dusk Rose	28658459	Dusk Rose	690	None	

1956 TWO-TONE COMBINATIONS

#	Model Usage Style Number	Upr Body	Duco #	Lwr Body	Duco #	Wheel	Dulux #	Wheel Strp	Duco #
696	150, 210 Series	Crocus Yel.	25358763	Onyx Black	2532247	Crocus Yel.	725	Onyx Black	2532247
696	Bel Air Series	Crocus Yel.	25358763	Onyx Black	2532247	Crocus Yel.	725	None	
700	Bel Air Series	Sierra Gold	28659894	Adobe Beige	25359895	Sierra Gold	742	None	
701	150, 210 Series	India Ivory	25358458	Onyx Black	2532247	Onyx Black	505	Argent Silver	2894202
701	Bel Air Series	India Ivory	25358458	Onyx Black	2532247	Onyx Black	505	None	
702	150, 210 Series	Shrwd. Grn.	28659525	Pncrst. Grn.	25358897	Pncrst. Grn.	716	Onyx Black	2532247
702	Bel Air Series	Shrwd. Grn.	28659525	Pncrst. Grn.	25358897	Pncrst. Grn.	716	None	
703	1011-19-37-39	Harbor Blue	28158812	Nassau Blue	25358752	Harbor Blue	719	Argent Silver	2884202
703	Bel Air Series (exc. 1062DF)	Harbor Blue	28158812	Nassau Blue	25358752	Harbor Blue	719	None	
705	150, 210 Series	India Ivory	25358458	Pncrst. Grn.	25358897	Pncrst. Grn.	716	Onyx Black	2532247
705	Bel Air Series	India Ivory	25358458	Pncrst. Grn.	25358897	Pncrst. Grn.	716	None	
706	150, 210 Series	India Ivory	25358458	Shrwd. Grn.	28659525	Shrwd. Grn.	717	Argent Silver	2894202
706	Bel Air Series (exc. 1062DF)	India Ivory	25358458	Shrwd. Grn.	28659525	Shrwd. Grn.	717	None	
707	150, 210 Series	India Ivory	25358458	Nassau Blue	25358752	Nassau Blue	718	Onyx Black	2532247
707	Bel Air Series	India Ivory	25358458	Nassau Blue	25358752	Nassau Blue	718	None	
708	210 Series	India Ivory	25358458	Dusk Plum	28159238	Dusk Plum	728	Argent Silver	2894202
708	Bel Air Series	India Ivory	25358458	Dusk Plum	28159238	Dusk Plum	728	None	
710	210 Series	India Ivory	25358458	Twlght. Turq.	25358920	Twlght. Turq.	723	Argent Silver	2894202
710	Bel Air Series	India Ivory	25358458	Twlght. Turq.	25358920	Twlght. Turq.	723	None	
711	150, 210 Series	India Ivory	25358458	Matador Red	25359446	Matador Red	738	Onyx Black	2532247
711	1011D-19D-67D	India Ivory	25358458	Matador Red	25359446	Matador Red	738	None	
715	1037D-39D-62DF-64DF	Matador Red	25359446	Dune Beige	25359144	Matador Red	738	None	
717	210 Series	Crocus Yel.	25358763	Laurel Grn.	28159423	Laurel Grn.	730	Argent Silver	2894202
717	Bel Air Series	Crocus Yel.	25358763	Laurel Grn.	28159423	Laurel Grn.	730	None	
721	210 Series (exc. 1011A)	India Ivory	25358458	Dawn Gray	28159692	Dawn Gray	755	Onyx Black	2532247
721	Bel Air Series	India Ivory	25358458	Dawn Gray	28159692	Dawn Gray	755	None	
754	210 Series	India Ivory	25358458	Trop. Turq.	25359789	Trop. Turq.	757	Argent Silver	2894202
754	Bel Air Series	India Ivory	25358458	Trop. Turq.	25359789	Trop. Turq.	757	None	

1956 TWO-TONE COLOR COMBINATIONS (CONT)

#	Model Usage Style Number	Upr Body	Duco #	Lwr Body	Duco #	Wheel	Dulux #	Wheel Strp	Duco #
755	150 Series	Calypso Cr.	25358458	Onyx Black	2532247	Calypso Cr.	790	Onyx Black	2532247
756	150, 210 Series (exc. 1271)	Grecian Gold	28190317	Calypso Cr.	25390209	Grecian Gold	794	Onyx Black	2532247
756	Bel Air Series	Grecian Gold	28190317	Calypso Cr.	25390209	Calypso Cr.	790	None	
757	210 Series	Inca Silver	88756303	Imperial Ivory	88559931	Imperial Ivory	799	Onyx Black	2532247
757	Bel Air Series	Inca Silver	88756303	Imperial Ivory	88559931	Inca Silver	759	None	
763	1039D-1062DF-1037D	Matador Red	2539446	Adobe Beige	25359895	Matador Red	738	None	

1957 TWO-TONE COLOR COMBINATIONS

#	Model Usage Style Number	Upr Body	Duco #	Lwr Body	Duco #	Wheel Color	Dulux #
807	150 (exc. 1508), 210, B/A (exc. Conv.)	India Ivory	25358458	Onyx Black	2532247	Onyx Black	505
808	150 (exc. 1508), 210, B/A (exc. Conv.)	Imperial Ivory	88559931	Inca Silver	88756303	Inca Silver	759
809	150 (exc. 1508), B/A (exc. Conv.)	-----	-----	Harbor Blue	28158812	Harbor Blue	719
809	210	Harbor Blue	28158812	Larkspur Blue	25390114	Larkspur Blue	808
810	150 (exc. 1508), 210, B/A (exc. Conv.)	India Ivory	25358458	Larkspur Blue	25390114	Larkspur Blue	808
811	150 (exc. 1508), 210, B/A (exc. Conv.)	India Ivory	25358458	Trop. Turq.	25359787	Trop. Turq.	757
812	150 (exc. 1508)	-----	-----	Surf Green	25390147	Surf Green	807
812	210	Surf Green	25390147	Highland Grn.	28859775	Surf Green	807
812	Bel Air (exc. Conv.)	Surf Green	25390147	Highland Grn.	28859775	Highland Green	822
813	150 (exc. 1508), B/A (exc. Conv.)	India Ivory	25358458	Surf Green	25390147	Surf Green	807
814	210, Bel Air (exc. Conv.)	India Ivory	25358458	Coronado Yl.	25390620	Coronado Yl.	819
815	150 (exc. 1508), 210, B/A (exc. Conv.)	-----	-----	Colonial Cr.	25358094	Colonial Cr.	809
815	210	Colonial Cr.	25358094	Onyx Black	2532247	Onyx Black	505
816	150 (exc. 1508), B/A (exc. Conv.)	-----	-----	Colonial Cr.	25358094	Colonial Cr.	809
816	210	Colonial Cr.	25358094	India Ivory	25358458	Colonial Cr.	809
817	210, Bel Air (exc. Conv.)	India Ivory	25358458	Cnyn. Coral	25390645	Cnyn. Coral	821
818	2124-09-19-29, B/A (exc. Conv.)	Adobe Beige	25359895	Sierra Gold	28659446	Sierra Gold	742
819	150 (exc. 1508), 210, B/A (exc. Conv.)	India Ivory	25358458	Matador Red	25359446	Matador Red	738
820	210	Colonial Cr.	25358094	Laurel Grn.	28190596	Colonial Cr.	809
820	Bel Air (exc. Conv.)	-----	-----	Laurel Grn.	28190596	Laurel Grn.	806
822	210	Dusk Pearl	88790354	Imperial Ivory	88559931	Dusk Pearl	812
822	Bel Air (exc. Conv.)	-----	-----	Dusk Pearl	88790354	Dusk Pearl	812

PAINT COMBINATION ABBREVIATIONS

Adobe Bge.....	Adobe Beige	Hrbr. Blue.....	Harbor Blue
Aut. Bronze.....	Autumn Bronze	Laurel Grn.....	Laurel Green
Calypso Cr.....	Calypso Cream	Matador Rd.....	Matador Red
Cnyn. Coral.....	Canyon Coral	Pncrst. Grn.....	Pinecrest Green
Cash. Blue.....	Cashmere Blue	Regal Turq.....	Regal Turquoise
Colonial Cr.....	Colonial Cream	S. Mist Grn.....	Sea Mist Green
Coronado Yl.....	Coronado Yellow	Shdw. Gray.....	Shadow Gray
Crocus Yel.....	Crocus Yellow	Shrwd. Grn.....	Sherwood Green
Grecian Gld.....	Grecian Gold	Shrln. Beige.....	Shoreline Beige
Imp. Ivory.....	Imperial Ivory	Trop. Turq.....	Tropical Turquoise
Harv. Gold.....	Harvest Gold	Twlght. Turq.....	Twilight Turquoise
Highland Grn.....	Highland Green		

1955 EXTERIOR PAINTS
—SOLIDS—



1955 INTERIOR FABRICS



Please note: Printed samples may not match actual colors.

1956 EXTERIOR PAINTS
—SOLIDS—



1956 INTERIOR FABRICS



Please note: Printed samples may not match actual colors.

1957 EXTERIOR PAINTS
—SOLIDS—



1957 INTERIOR FABRICS



Please note: Printed samples may not match actual colors.

18. Ordering & Shipping

The Ordering and Shipping section is where you will find information regarding how you can place an order with us, and what our shipping policies are. We also cover what shipping methods are available to you whether you are shipping in the contiguous 48 states, or somewhere like Japan, Australia, Canada, Mexico, Europe, or anywhere else on the globe. We ship worldwide.

We explain how our shipping charges work, what methods of payment we accept, (check, money orders etc.) and how we handle things like backorders, returns, exchanges, special order parts, drop ship orders, defective parts, and damaged shipments. We also cover what our policies are regarding these things and any fees that you may incur.

Also, you will find operating hours for our Santa Ana, California location, as well as the phone numbers, fax numbers and email addresses that you can use to contact us. All this is covered in the Ordering and Shipping section.

EAST COAST HOURS:**MONDAY - FRIDAY: 10:00 AM - 8:00 PM EST****SATURDAY: 11:00 AM - 5:00 PM EST****WEST COAST HOURS:****MONDAY - FRIDAY: 7:00 AM - 5:00 PM PST****SATURDAY: 8:00 AM - 2:00 PM PST****PHONE LINES:****ORDER LINE: (800) 854-6911****FAX LINE (24 HOURS): (714) 850-1957****INQUIRY/TECH ASSISTANCE: (714) 751-1957****NO TECH CALLS TAKEN FROM: 12:00 Noon - 1:00PM PST****ONLINE:****WEB SITE: WWW.DANCHUK.COM****E-MAIL: INFO@DANCHUK.COM****ORDERS@DANCHUK.COM****CUSTSERV@DANCHUK.COM****SOCIAL MEDIA: DANCHUKUSA** **ORDERING INFORMATION:**

Thank you for relying on Danchuk. We are equipped to receive your orders by telephone, mail, fax, e-mail, or in person. Most orders are shipped within 24 hours, and we offer a rush service for those in a real hurry!

Telephone Orders: Our toll-free order lines serve all 50 US states and Canada.

Mail and Fax Orders: Please provide a complete billing address, shipping address (if different), home telephone with area code, method of payment, email and a complete vehicle profile. Also, please call for freight charges prior to mailing in your order. If you have a fax machine, you may place your orders on our fax line 24 hours a day, 7 days a week. California residents must add applicable sales tax.

Online Ordering: You may place your order over the internet via our website, www.danchuk.com.

Ordering in Person: Feel free to visit our showroom during the hours listed above. Take a look at the many parts we have on display and pick up what you need. If an item you want to order is on backorder, we will gladly call you when the part arrives and you can come back and pick it up. If you prefer to have the part shipped to you, applicable shipping charges will be added.

Counter Customers/Will Call Orders: Please feel free to phone, fax or e-mail your order to us before coming in to our showroom to pick it up. We will hold your will call order for 72 hours.

Backorders: If an item is out of stock at the time you place your order we will put it on backorder. When the item becomes available, we will contact you via phone and/or email to confirm you still want the item shipped to you. If we are unable to reach you, customers have 5 business days to call or reply to our message(s). If we do not receive a reply from the customer after 5 business days, the order will be canceled. All backordered items incur applicable shipping on them when they ship regardless of how the order was originally placed (in person, through the mail, over the phone, fax or internet). We reserve the right to cancel backordered items on international orders if the cost of shipping them would be prohibitive. Customers whose backorders are canceled by Danchuk will be notified of the cancellation. If you do not wish us to backorder items for you, please inform us at the time you place your order.

Special Order Items: Orders for upholstery items (such as seat covers, headliners, some carpets and door panels), some A/C units, glass and other items are special ordered and must be prepaid. A signed waiver form for all special order upholstery items is required at the time the order is placed. Also, upholstery orders are charged a \$10 handling fee which is charged to us by our vendors. We can only accept returns of special order items if the items are damaged or defective.

Drop Ship Orders: Some parts lines we carry, such as glass, carpets, upholstery, chassis, bodies, engines, and some sheet metal are too extensive to warehouse at our facility so we drop ship them directly to you from our vendors. Drop ship orders must be prepaid and may incur a small drop ship fee in addition to the shipping charges noted throughout the catalog. All shipping charges mentioned in the catalog are for destinations within the 48 contiguous states only. Please call for a shipping quote for Alaska, Hawaii, Puerto Rico and all international destinations.

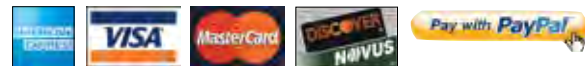
METHODS OF PAYMENT:**MasterCard, Visa, American Express and**

Discover: Please provide the card number, expiration date, CVV security code, cardholder's name, and credit card billing address, and on mail orders, the cardholder's signature. Your account will not be charged for any item until that item is shipped.

Check or Money Orders/Cashier's Checks: Your personal or company checks, money orders or cashier's checks are welcome, but may be held up to 10 days for clearance. All forms of payment must be in US funds, and drawn on a US bank. There will be a \$35 service charge for all returned checks.

PayPal: We have now added PayPal for your convenience.

Gift Cards: Danchuk Gift Cards can be purchased via phone or in person and can be used towards parts and taxes on phone and walk-in orders.

Walk-In Cashier's Checks: Due to our check verification system, we can no longer accept cashier's checks from our walk-in customers.

C.O.D. : We no longer offer C.O.D. service.

SHIPPING CHARGES:

Charges are added to your order total and are based on your method of payment.

Visa, MasterCard, American Express & Discover: ONLY actual shipping charges will be charged to your card account.

Check, Money Orders or Cashier's Checks: Please contact us for shipping charges prior to sending a check, money order or cashier's check.

General Information: For the safest and most economical shipping method, specify a business address for us to ship to.

Free Shipping Promotions: In the event Danchuk offers a free shipping promotion, only parts without the oversized, overweight, additional handling or truck freight symbols are eligible to ship ground for free to the contiguous 48 US states only (end users only). Any orders with parts designated as oversized, overweight or additional handling will ship separately, and the customer will be charged normal shipping costs for these designated parts. For internet orders, Danchuk charges shipping upfront, and refunds shipping after review, if order qualifies. Please call customer service with any questions regarding your order.

Rush Services: If you need your parts right away, we have rush services available to customers in the US and many foreign countries. Rush orders must be placed by 10 AM Pacific time, and paid for by credit card. We will ship your rush order via the air service you select (see Shipping Methods, on next page) for the actual shipping cost.

O/S Oversized and Overweight Items: Oversized and overweight items are those which exceed the normal size and/or weight limitations of our selected carriers. Our shipping carriers charge additional fees for all oversized and overweight items which incur additional charges for customers and make these parts ineligible for any free shipping promotions. O/S charges are normally between \$12-\$20 extra per package. Please note that some exhaust systems will incur a flat shipping charge of approximately \$175 to the contiguous 48 US States.

T/F Truck Freight: Some items are too large to be shipped FedEx and need to be shipped truck freight. These items are noted throughout our catalog using the T/F symbol. Orders requiring truck freight shipment must be prepaid. Also, there can be occasions where we are charged additional fees over and above the cost of the transportation. These include, but not limited to, an additional charge for residential delivery, liftgate delivery, re-delivery, if shipment exceeds 180 pounds and/or if no one is available at the delivery address to assist the driver with the unloading of the shipment. Each of these issues can incur an additional fee per incident in excess of \$50 each. In the event that we are charged additional fees by the trucking company, we may contact you to arrange payment for the additional fees incurred. Please call customer service for an estimate of truck freight charges. **IMPORTANT: Please inspect all truck freight shipments for concealed damage before signing the freight bill. If driver refuses to allow inspection, then note when signing freight bill and ask driver to initial. Damage claims cannot be made after freight bill has been signed.**

SHIPPING OUTSIDE THE 48 STATES

Hawaii, Alaska, US Territories and Possessions: Most orders ship FedEx or USPS Priority Mail, depending on the size and weight of your order. Alternate shippings services can be used, if desired. Please call customer service for a shipping quote for your order.

All Foreign Countries: We welcome international orders! Please indicate the shipping method you wish to use. If you do not specify a shipping method, or if we cannot use the one you choose, we will select the method we feel offers the best balance of speed, cost and reliability. Typically, we ship via FedEx or USPS Priority Mail. We can also ship your order to your freight forwarder.

Customs and Duty Charges: Orders to foreign countries may incur customs and duty charges, customs broker fees, and other charges related to the importation of merchandise. All such charges are the responsibility of the recipient.

Insurance: All orders shipped to international destinations, regardless of shipping method, will be insured for the full amount of the parts ordered. The cost of the insurance will be added to your order.

SHIPPING METHODS

FedEx Home Delivery (Residential Ground Service): This service is available to all residential addresses within the 50 states and Puerto Rico featuring guaranteed delivery between 1 and 5 business days (3-7 business days to Alaska & Hawaii depending on location). Delivery is between 9 am and 8 pm Monday through Saturday. FedEx Home Delivery

picks up Monday - Friday. When possible, please provide us with a business (commercial) address to where we can ship your order. FedEx charges a nominal fee for delivery to residential addresses.

FedEx Ground (Commercial Ground Service): This service is available to all commercial addresses within the 50 states and Puerto Rico featuring guaranteed delivery between 1 and 5 business days (3-7 business days to Alaska & Hawaii depending on location. You will need to provide a business (commercial) address to ship via FedEx Ground Commercial.

FedEx International Ground (Service to Canada): This economical service is day-definite delivery to Canada typically in 2-7 business days with delivery by the end of the business day. Customs and brokerage fees apply. Please call for more information.

FedEx Express Saver (3-Day Service): This cost effective service guarantees delivery within the 48 contiguous states by 4:30pm of the 3rd business day to commercial addresses. Delivery to residential addresses is by 8pm of the 3rd business day. Not available to Alaska & Hawaii.

FedEx 2nd Day: This service guarantees delivery to all 50 US states the 2nd business day by 4:30pm to most commercial addresses and by 8pm to residential addresses, and delivery in 3 business days for certain shipments to Alaska and Hawaii. Saturday delivery is available for an additional \$16 charge per package.

FedEx Standard Overnight: This service guarantees delivery to all 50 states the next business day by 3pm to most areas and by 4:30 pm to some rural areas and by 8pm to residences. Saturday delivery is available for an additional \$16 charge per package.

FedEx Priority Overnight: This service guarantees delivery to all 50 states the next business day by 10:30am and by noon, 4:30pm or 5pm to some rural areas. Delivery in 2 business days for certain shipments to Alaska or Hawaii. Saturday delivery is available for an additional \$16 charge per package.

FedEx International Economy: This service delivers typically in 2-5 business days to more than 215 countries and territories. Delivers typically in 2-3 business days to most major markets in Canada, Mexico and Puerto Rico. Please call for more information.

United State Postal Services available.

Other International Air Freight: We do business with several international air freight companies in addition to FedEx. We use them only for orders containing items too large to ship via FedEx (see "Oversized Items," on page 725). Delivery time is seven to ten days.

Truck Freight: Used for orders within the 48 states which contain items larger than "oversized" that require a Truck Freight company to deliver (see "Truck Freight Items," on page 725). Delivery time is seven to ten days.

RETURNS AND EXCHANGES

Returning Parts: If you need to return a part to us for any reason, please call before shipping the part back to us. We would like to discuss the problem with you and issue a Return Merchandise Authorization number. Please place the RMA number on the outside of the box and include a copy of your receipt. Please understand that we cannot accept returns sent C.O.D. All returns must be shipped with the freight prepaid, properly packed and insured for the full value of the part and be in the same condition as delivered. Unless the part is defective, or we shipped it to you in error, you will be responsible for all shipping charges incurred. In rare cases you may be subject to a 20% restocking fee. Returns made within 30 days of purchase will be refunded in the original payment form, provided part(s) is unopened and in sellable condition. Returns made after 30 days of purchase will be given store credit in the form of a DanChuk gift card, unless item is defective. Returns accepted after 90 days need special authorization. Some items will be returned to the manufacturer for warranty repair.

Non-Returnable Items: The following items may not be returned for refund or credit: all electrical items, opened and/or installed items, all special order items and discontinued/clearance items. Should you receive a defective item, we will be happy to replace it. Some items will need to be sent to the manufacturer for warranty repair.

Damaged Shipments: Please inspect your package immediately upon receipt in the presence of the delivery person. Examine the box for any visible outside damage, as well as the parts inside for any hidden damage that may have occurred during shipping. In the rare event that your package is damaged in transit, you must file a claim with the delivery company immediately, as most delivery companies have set time limits on damage claims notifications. Failure to do so may result in the loss of your claim. Do not send the package back to us. The delivery company will send a representative out to your location to examine the package and its contents so it is very important that you retain all packaging until the claim is settled.

Parts Ordered In Error: If upon receipt of your order, you determine that you have ordered the wrong part, or you decide that you no longer want the part you ordered, please call us immediately. We will be happy to exchange the item you ordered for the correct item or give you store credit in the form of a Danchuk gift card or a full refund if you notify us within 30 days of delivery. You will be responsible for all shipping charges incurred.



Defective Parts: If we have shipped a defective part to you, please call us immediately. We will be happy to exchange the item or refund your money in full within our 90 day guarantee period. Please see “Non-Returnable Items” above.

Parts Shipped in Error and Shortages: Please check all packages immediately upon receipt and notify us within 10 days of delivery if you discover an error or shortage. We will ship the correct item to you or give you store credit in the form of a Danchuk gift card for the price of the missing part if we are notified within 10 days of delivery.

Undelivered Shipments: Most carriers will leave a notice at the shipping address and/or return on another day to attempt delivery if they are unable to deliver your shipment to the specified address. If they are still unable to make delivery, the package will be returned to us. We will then contact you to make further arrangements. If you refuse a shipment of parts which you ordered from us, the package will be returned to us. We will then contact you to make further arrangements. In any of the above events, you will be required to pay the shipping charges incurred before we will reship the order or ship any new orders.

PRICING

Danchuk is committed to providing you with the highest quality parts at the lowest prices possible and we will make every attempt to honor the prices in this catalog. Unfortunately, there are times when doing so is beyond our control. Therefore, the prices in this catalog are subject to change without notice. Prices in our 2020 catalog supersede all previously printed catalog pricing. As a rule, the prices on our website will be the most accurate and up to date.

We work so hard to be sure we have the best pricing in the industry that we proudly guarantee it. You can come to Danchuk and purchase your products with the confidence of knowing that if you find the identical product at a competitor we will match the price! That's right, if the identically manufactured item is currently advertised in a competitor's catalog or website (URL required) for less we will match the price. All you need to do is send us a copy of the currently advertised price from their catalog or website within 30 days of your purchase and it's done. The competitor must be in the restoration industry and the offer is limited to their current published price at the time of purchase.

GENERAL INFORMATION

Guarantee: All of our parts are guaranteed for 90 days to be free of defects in materials and workmanship. Of course, this guarantee does not apply in the event of any misuse, neglect, or improper installation. Your remedy is limited to Danchuk replacing any defective product sold to you. In no event will Danchuk's liability exceed the purchase price paid to Danchuk for the products. Danchuk expressly disclaims all warranties not expressly stated herein. Danchuk makes no warranties, expressed or implied, as to any product's merchantability of fitness for any particular purpose. Buyer is solely responsible for determining the proper application and use of the products. Danchuk will have no tort liability to buyer with respect to any of the products and will not be liable to buyer or any other party for loss of property, special, incidental, consequential, or punitive damages arising out of the use or inability to use the equipment in which the product is installed, or indirect or other similar damages arising from breach of warranty, breach of contract, negligence, or any other legal theory, even if Danchuk or its agent has been advised of the possibility of such damages.

General Policies: Modification of a vehicle in any way may require corresponding modifications to other systems to achieve desired performance and necessary safety. We recommend that you seek professional advice and/or assistance with any modification. Danchuk Manufacturing, Inc. reserves the right to change all prices, terms, specifications, and other information without notice. The information in this catalog is compiled from sources that we believe to be reliable, but the accuracy thereof is not guaranteed. Please call if you have any questions or think that there is a discrepancy. The information and policies herein supersede all preceding information and policies.

California Proposition 65 Compliance: California Proposition 65 requires businesses to provide warnings to Californians about significant exposure to chemicals that can cause cancer, birth defects or other reproductive harm. These chemicals can be in products or workplaces, or that are released into the environment. By requiring warning information be put on these products, Proposition 65 enables Californians to make informed decisions about their exposures to these chemicals.

Proposition 65 requires California to publish a list of chemicals known to cause cancer, birth defects or other reproductive harm. This list, which must be updated at least once a year, has grown to include approximately 800 chemicals since it was first published in 1987.

We have taken the necessary steps to include a Prop 65 warning label on all products that may include a chemical from the list that the State of California deems toxic or harmful. Warning labels will also be included on the packaging for the products that have been identified as possibly containing these chemicals.

Please contact Danchuk if you have any questions or concerns.



The GM Restoration Parts Bel Air, Two-Ten, One-Fifty, Fisher Body, Guide, Chevrolet and Bowtie emblems are trademarks of General Motors Corp. and are used under license.

PARTS INDEX

Many Parts are listed under more than one heading. For Example, "Back-up Light Lenses" are found under the subheading "Back-up", in the heading "Lenses". The same part can also be found under the subheading "Lenses" in the heading "Back-up Light."

A	
A-Arms & Related	282, 426-428
A-Pillar Panels & Related	558-559
Windlace Retainers	148
Absorbers, Shock	435-437
Accelerator	
Linkage & Related	324-325
Pedal & Related	152-157
Pedal Rod Bushings	325
Pump Assembly, Edelbrock	337
Access	
Cover, Tailgate	171, 174, 654
Cover, Nomad Cargo	648
Hole Covers	619
Panel Screws	619
Plugs	
Door Upper	619
Rear Body, Mount	578, 604
Trunk Area Inner	167, 604
Accessory	
ARP Fastener Kit	489
Booklets/Manuals	660
Bumper Guard Supports	52
Drive System	505-509
Fasteners	489
Fender-to-Fender Skirt Seals	551, 606
Gas Door Guard	37
Rear Deck Moulding Trim Kit	41
Acoustishield	158
Actuators, Door	621
Adapter(s)	
Clock Bezel	113
Engine Brackets	490
Engine Sender	104
Engine Stand Axle	694
Fittings, Master Cylinder	465
Fittings, Temperature Sender	103
Flare to Pipe Pressure	301
Gauge Kit	108
Hub	392, 395
In-Line Hose	386
Lecarra Steering	393
Lokar Shift Knob	528, 530
Mount, Clock	113
Oil & Water Sender Kit	121
Oil Filter	499
Bolts	498
Plate, Carb, Edelbrock	339
Power Steering Centerlink	421
Power Steering Pump	417
Fitting	415
Russell Performance	300-301
Sender, Oil/Water	121
Shifter Knob	530
Steering Wheel Hub	392-393
Tachometer	104
Tapered Port Carb	339
Additives	685, 687
Adhesive, Weatherstrip	644, 677
Adjustable	
Bell Housing Clutch Fork Pivot	526
Coil Over Kits	437
Column Shift Linkage Arm Kit	523
Engine Adapter Bracket	490
Fan Thermostat & Harness	368
Hood Stop Kits	285, 288
Proportioning Valve	459
Shock Absorbers	437
Steering Column Shift Linkage	403
Transmission Cooler Bracket	519
Transmission Shift Arm	403
Wrench for Fittings	692
Adjuster	
Bezel, Seat	134
Bolts, Vent Window	642
Brackets, Grille Tie Bar	30
Adjusting	
Brake Hardware Kits	469
Brake, Screw	470
Plate and Hardware, Window	627
Plates, Quarter Window	638
Seals, Window Channel	627
Adjustment	
Bolt, Glass Track	635
Bracket, Generator	241
Carburetor Regulator	332
Emergency Brake Rods	472
Rubber Brake Hole Plug	467
Screws	319
Sleeve, Tie Rod	424
Swivel Nut, Shift Linkage	409, 523
Traction Bars	429
Advance Curve Kit	266, 272
Advance, Vacuum	269, 272
Aeromotive	329-333
Fuel Tanks	306
Air Cleaner(s) & Related	326-328, 348
Braces, Valve Cover	297
Carburetor, Rods	317
Brackets	505
Compressor Brackets	390
Air Conditioning & Related	389-390
Belts	502
Brackets	505-507
Cooling Modules	383
Dash Vents	91
Electric Fan Relay Kit	374
Maintenance Books	662
Servicing Manuals	664
Air Duct	328
-to-Inner Fender Seals	371
Drain Tube	371
Fresh, In Fender	371
Retainers	370
Air Filter Recharger Kit, K & N	684
Air Horn Gasket	317
Air Inlet & Related	371
Air Vent Assembly & Related	370
Air Vent Seal Kit	371
Air-Gap Manifold & Carb Kit,	
Edelbrock	338
Alignment Kit, Trunk Lid	167
Plugs	246
Alternator(s) & Related	244-246
Brackets	390, 504-506
Plugs	246
American Legend Wheels	482-483
American Racing Wheels & Caps	479
Amplifier, Stereo	255
Amsoil Products	685-687
Analog Clocks, Dakota Digital	119
Analog, Evans Coolant Refractor	385
Anchor Bracket	308
Anchortite Locking Dipsticks	
Engine	494
Transmission	520
Anode, Radiator Zinc	386

Antenna & Related.....	253, 260	Switch	78, 275, 532	Shock Mount Kits	427, 437
Front Fender Plug	280, 283	Backing Plates		Steering Column Bushing	402
Anti-Squeak Gaskets		Door Hinge	617	Wheel	422, 431
Fender & Hood	551, 606	Heater Lens	363	Grease	680
Anti-Sway Bars & Related	436, 440-441	Parklight Housings	76	Bel Air Scripts.....	21
Antifreeze, Be Coolant Super Duty.....	681	Backrest Support & Brackets	600	Bel Air Dash Scripts.....	91
Arm(s)		Backseat Driver Speaker Assembly	256	Belera Gauges, Classic Instruments.....	111
Adjustable Column Shift Arm	523	Baer Disc Brake Conversion Kits	453	Bell Crank Shift Linkage.....	524
Brake Pedal Arms	156	Master Cylinders & Prop Valves.....	463	Bell Housing(s)	
Clutch Pedal Splined Output.....	524	Baffle(s)		ARP Stainless Bolt Kits	510
Heavy Duty	525	Alternator	244	Brackets & Cover, Lower	526
Gas Pedal.....	155	Cargo Floor Support.....	595	Clutch Fork	526
Gear Shift	399-400	Hood	288, 538	Mount Starter	243
Glove Box Door	122	Center Brace.....	287, 538	Belt(s)	
Idler & Related	420-423	Oil Pump Pan	497	Air Conditioning & Fan	502
Pitman & Related.....	410-411	Bag, Convertible Top Boot.....	179	Center Post Mouldings.....	45
Rebuild Kit, Liftgate.....	649	Balancer, Harmonic & Related	500	Door Moulding Screws	619
Shift, Lokar Transmission.....	403	Ball(s)		Moulding Screws.....	180
Steering.....	421	Joints & Related	423	Seat & Related	130-132
Throttle.....	319	Caps	428	Beltline Mouldings & Screws	45
Turn Signal.....	399	Stud, Pitman Arm, Power Steering....	410	Bezel(s)	
Wiper.....	632	Tailgate, Lower.....	653	Cigarette Lighter	93
Armrest(s) & Related....	128-129, 563, 601	Ballast Resistor	263, 268	Clock	101, 106
ARP		Covers.....	283	Adapter	113
Bell Housing Bolts	510	Bandanas, Danchuk	703	Delete	89
Drive Balancer Bolts.....	500	Bands, Exhaust Clamp	356	Dash Sets.....	88, 90
Engine Accessory Fastener.....	489	Bands, Metal Door Panel	146	Dimmer Switch	157
Flexplate Bolt Kits.....	488	Banjo Carb Fitting	340	Dome Lens.....	80
Motor Mount Bolts	490	Banjo Pressure Fitting.....	416	Headlight Related	70-71
Square Drive Balancer Bolts.....	500	Bar(s)		Heater Control	362
Stainless Bell Housing Bolts	510	Anti-Sway & Related.....	440-441	Hood & Trunk with Emblems	18
Stainless Valve Cover Bolts.....	296	Brackets		Ignition Switch & Nut.....	90,262
Stainless Water Pumps Bolts.....	504	Harness to Inner Fender Clip	29	Insert Decals, Headlight	71
Starter Bolt Kits.....	243	Support	28	Instrument Cluster	100
Timing Chain Cover Bolts	495	Continental Kit Spacer.....	58	License Lens	81
Torque Converter Bolts.....	515	CPP Sway.....	438-439	Lokar Shifter Boots with Sliding	529
Transmission Pan Bolts.....	516	Division Channel Stops.....	634	Nuts, Ignition Switch.....	263
Ashtray & Related.....	124	Emblems, Grille.....	19	Radio, Knob Set.....	89
Armrest.....	128	Grille	28	Seals, Headlight	71
Assembly Manuals	660	Adjuster	30	Seat Adjuster.....	134
Assembly Pad		Tie & Tie Support.....	31	Speaker	101
Continental Kit Lock Support	58	to Fender Brace Support	549	Speaker Dash	92
Atomic EFI, MSD.....	347	Hellwig Sway	440-441	Speedometer Cluster	101
Attaching Strip, Door Panel	147, 620	Hood and Extensions.....	32-33	Taillight.....	62
Auto		Parking Brake Spreader	470	Bill's Hot Rod Brackets	506-507
Detailing	676-679	Radiator Core Support	542-543	Billet Specialties	
Glass Sealant.....	680	Sway and Related	438-441	Air Cleaner	327
Auto Meter Gauges & Related		Tailgate Center.....	55	A/C Brackets.....	390, 504-505
.....	104-109, 253	Torsion, Rear Door.....	168, 646	Alternator Brackets.....	504-505
Battery Extenders.....	236	Traction.....	428-429	Alternator Pulley	246
Auxiliary Circuit Boss Fuse Blocks.....	239	Barriers, Thermo-Tec Heat	302	Breather Caps.....	299
Auxiliary Fuse Block Buss Assembly	240	Base(s)		Crank Pulleys.....	501
Axle		Antenna	260	Dimmer Switch Covers.....	276
Engine Stand Adapter.....	694	Armrest.....	128	Distributor Clamps	264
Housing Gasket.....	498	Carburetor Gaskets	317, 338	Fuel Pump Block Off Plates	313
Flange Seal	431	Battery(ies) & Related	234-237	Hood Hinges.....	285
Rear Bearing & Related	422, 431, 476	Terminal Boot, Alternator	246	Horn Buttons & Hub Adapters	395
Rear Bumpers and Retainers.....	431	Terminal Protector.....	683	License Plates Frames.....	56
B		BatteryMinder	236	Motor Mount Plates	492
B. F. Goodrich Tires.....	484	Batwing Air Cleaner	328	Overflow Tanks.....	386
B-Pillar Panels & Related	559	Be Cool Radiators	378	Pedals & Related	153
Lower Patch Panels.....	564	Bearing(s)		Power Steering Hose Kit	417
Support Braces.....	574	Clutch Release.....	525	Power Steering Pump Brackets.....	413
Back Body-to Bumper Seals.....	54	Front Wheel.....	476	Power Steering Pump Reservoirs.....	418
Back Assembly, Seat.....	139	Idler Arm Kit	423	Power Steering Pulleys	414
Back-Up Light & Related.....	78-79	Manual Steering.....	420	Pulley Systems	508
Neutral Safety Switch.....	276	Rear Axle Bearings	422, 476	Spark Plugs Wires & Related	273
		Rear Axle Retainer & Hardware.....	431	Steering Wheels.....	394
		Roller Conversion Kits	422, 476	Valve Covers	294

Hold-Downs	297	Leaf Spring	433	MSD Ignition Controller	269
Water Pump Pulleys	502	License Plate.....	57	O-Ring Fittings, Steering Box	419
Bilstein Shock Absorbers	435	Locks, Exhaust Manifold.....	356	Pertronix Ignition	272
Birds, Fender	47	Manifold	323, 356	Steering & Related	402, 409-411
Birds, Hood.....	32-33	Motor Mount.....	490	Brace(s)	
Blade, Wiper	632	Oil Pan	498	Cargo Floor	595
Blanket, Exhaust	360	Rear End Cover.....	432	Convertible	
Blanks, Key.....	614	Rear Glass Track Adjustment.....	635	B-Pillar Braces & Brackets	559
Bleeders, Speed	465	Rear of Hood Brace	283	Floors.....	568
Bleeding, Syringe, Brake	465	Seat	174	Lower Trunk Lid Hinge Support.....	583
Block Clip, Inner Fender Terminal	248	Spare Tire Retaining.....	167	Rear Window.....	591
Block(s)		Square Drive Balancer	500	Top Cylinder.....	178, 600
Brake Junction, Brass.....	469	Starter, & Shims	242-243	Top Mount	176
Carburetor Spacer	316	Stock Spindle.....	458	Fender, Rear.....	550
Cirkit Boss Fuse.....	239	Tailgate	654	Fender to Inner Fender	549
Clips, Inner Fender Terminal	248	Thermostat Housing	369	Firewall.....	552
Distribution Kits.....	459	Timing Chain Cover	495	Floor	574-575
Fuse & Related	240	Top of Grille Set (Fake Rivet Head)	30	Hood & Related	287-289, 538
Junction Brake Line	474	Torque Converter.....	515	Bolt	283
Leaf Springs Rear	433	Trans Mount to Bell Housing	510	Hood, Eddie Motorsports.....	287
Block-Off Panels, Fresh Air Duct	279	Trans Mount to Frame.....	510	Quarter Panel Support	589
Block-Off Plate.....	323	Transmission Pan	516	Rear Door Jamb	565
Fuel Pump	313	Treadle-Vac Plunger Rod Shoulder	465	Rear Quarter Fender to Bumper	589
Quarter Panel Fin.....	586	Trunk Lid Hinge & Latch Plate.....	169	Rocker Panel	557
Blower Motor & Related.....	275, 366	Valve Cover.....	296	Roof	590
Blower Switches	275	Vent Assembly	642	Seat Back	562
Blue Dots w/ Bow Tie Emblems	64, 66	Water Neck.....	369	Seat Riser to B Pillar Support.....	574
Bluetooth Radios	254-255	Water Pump	503-504	Speaker	255
Body		License Plate.....	57	Tail Panel, Nomad & Wagon	594
-to-Bumper Seals, Back	54	Booklet(s)		Tailpan	594
Adjustments Guide.....	663	Accessory	660	Trunk Floor	572
by Fisher Service News.....	663	Convertible Owners.....	662	Trunk Lid Hinge Support.....	583
Grommet, Gas Tank.....	308	Electric Wiper Service	663	Trunk Panel	579
Kit, MSD Atomic.....	347	Suggested Delivered Price.....	663	Trunk Splash Pan	581
Mouldings and Attaching		Books	660-671	Valve Cover Air Cleaner	297
Parts Guide.....	663	Booster, Power Brake & Related	460-461	Bracket(s)	
Mount & Related.....	604-605	Boot(s)		Aeromotive Fuel	330
Mount Access Plugs, Rear.....	604	Ball Joint	423	Air Cleaner	328, 348
Mount Reinforcements	578	Battery Terminal	246	Air Conditioning	505-507
Skeleton.....	603	Clutch Bell Housing	526	Compressor.....	390, 504
Taillight Housing.....	67	Convertible Top Bag	179	Alternator	505-507
Body By Fisher Sill Plate Tags.....	143	Emergency Brake Cable	473	Alternator Conversion	245
Bolt(s)		Lokar Emergency Hand Brake.....	471	Armrest.....	128
Adapter, Oil Filter.....	498	Lokar Shifter	529	Assembly, Tailgate Bumper	654
ARP Flexplate.....	488	Radio Speaker	254	B-Pillar	559
ARP Torque Converter.....	515	Retainer, Convertible Top	178	Back-Up Light Cover Retainer	78
Bell Housing.....	510	Ring, Shifter, Lokar	529	Backrest Support	600
Body Mount.....	604	Shifter, Lokar.....	529	Bill's Hot Rod	506
Brake Line & Exhaust Bracket	474	Spark Plug Wire	273	Billet Specialities.....	504
Bumper.....	54	Snaps, Convertible Top	179	Body Mount Frame.....	605
CAM Lock Header	357	Starter Solenoid	243	Brake Hose-to-Mounting Clips	468
Continental Kit	58	Tie Rod End.....	423	Brake Line.....	474
Convertible Top Cylinder Rod.....	177	Bottoming Stop, Window	637	Bucket Seat Adapter	141
Crankshaft Pulley.....	501	Bottoms, Door	564	Bumper.....	49, 51
Cylinder Head.....	341	Bow(s)		Bumper End	53
Door Hinge to Door.....	617	Assembly, Convertible Top.....	175	Carburetor Mounted Linkage	315
Emergency Brake Roller.....	473	Convertible Front Header	175	Clamp Screw, Ignition Coil	264
Exhaust Manifold	356	Headliner	144, 173	Clock Retainer	102
Firewall Set	280	Bowl Float Bolt Kit	314	Clutch Bell Housing	526
Flexplate.....	488	Bowl Fuel Filter, Gas.....	314	Clutch Frame.....	525
Frame	181	Bowl to Carb Fuel Filter Fittings.....	315	Clutch Pedal Rebound & Stopper.....	524
Fuel Pump	313	Box(es)		Compass	125
Gas Tank Mounting Strap.....	307	Battery.....	234-235	Compressor, A/C.....	504
Harmonic Balancer.....	500	Fuel Door	314	Continental Kit Bumper to Frame	58
Header.....	357-358	Glove & Related	122-123	Convertible	
Hood Hinge.....	289	Ground.....	129	Backrest Support.....	600
Hood Stop	288	Heater	364	Cylinder Brackets	176
Intake Manifold	323	Ignition	269, 272	Sunvisor	127, 180
Jack, Continental Kit.....	58	Lock Set, Glove.....	122	Top Pivot	176

Top Switch	179	Tailgate Reel.....	653	Ashtray	124
Cooler, Derale	518-519	Tailpipe Hanger.....	358	Axle Rubber, Rear	431
Cowl to Fender Mount.....	548, 556	Throttle.....	318, 340	Bolts.....	54
Derale Transmission Cooler	518	Cable	318, 320, 530, 532	Bracket.....	49, 51
Disc Brake Conversion Kit.....	450	Solenoid.....	321	Bracket Assembly, Tailgate.....	654
E-Stopp Cable	472	Transmission Cooler.....	519	Brake & Clutch Pedal	525
Emergency Brake Floor	473	Transmission Cross Member End.....	512	Bullets.....	50
Engine Adapter.....	490	Trunk Latch Mount.....	583	Continental Kit	58
Fan Mounting	373	Tuned Port	320	Cowl Top Outer Corner Rubber.....	283
Fender.....	548, 550, 556, 589	Universal Coil, MSD	268	Detent Slide	524
Extension Support	47	Washer.....	283	End Brackets.....	53
Rockers with	556	Wire Loom Kit.....	273	Ends & Related.....	53-54
Skirt.....	550,551	Braided Line Clamp Kits, Notchhead.....	468	Front	48
Fire Extinguisher.....	123	Brake(s)		Gas Door Rubber.....	314
Front Fender Support	550	& Caliper Grease	680	Glove Box.....	123
Fuel Filter	330	& Clutch Pedal Bumper	525	Guard(s) & Related.....	52
Fuel Injection Studs.....	346	Adjusting Springs & Screws	469	Guards.....	50, 53
Gas Door Filler.....	314	Bleeding Syringe.....	465	Hardware	52
Gas Tank Pipe Support	308	Booster Conversion Kits & Related	448, 451, 460-461	Hood	282, 289
Gas Tank Strap Anchor	308	448, 451, 460-461	Insert.....	50
Generator	415	Cable Kits	471	Kits, Rubber.....	645
Generator & Adjusting	241	Calipers	458	Liftgate Stop Rubber	649
Mounting.....	241	CRC Brand Products.....	682	Mounting Hardware	53
Grille Bar Support	28	Disc Conversion & Related	448-455	Nomad Rear Sliding Window	645
Grille Tie Bar Adjuster	30	Drums & Related.....	467	Quarter Window Drain.....	638
Grommets, P/S Ram Cylinder to	420	Emergency & Related	471-473	Rear	51
Headlight Mounting.....	540	Handles, Emergency.....	123	Rear, to Rear Quarter.....	589
Heater Hose	368	Hardware Kits.....	469	Retainers, Rear Axle.....	431
Hood Hinge to Fender.....	289	Hold Down Kit	469	Rubber Kits.....	280
Hood Rocket.....	34	Hose(s)	468	Rubber, Glove Box.....	123
Ignition	264	Brackets.....	465	Rubber, Rear Quarter Drain Stop	638
Wire Support.....	262	to Mounting Bracket Clips	468	Seals, Back to Body	54
Inner Quarter to Upper Support Panel		Junction Blocks	469	Seat latch Bumpers.....	645
Convertible	601	Light & Harness, Third.....	68	Stickers	708
Kickdown	532	Light Attention Module	68	Tailgate Related	654
License Plate.....	57	Lines & Related	474-475	Trunk Rubber.....	167
Linkage.....	325	Frame Clips	313, 468	Window, Sliding Rear	645
Master Cylinder.....	464	Kit, Roadster Shop	446	Bushing(s)	
Motor Mount-to-Engine.....	491	Master Cylinder & Related.....	464-465	A-Arm & Related	426-427
& Conversion.....	490	Pads, Disc	466	Accelerator Pedal Rod	325
Muffler Hanger.....	358	Parking & Related	470	Bearing Kit, Steering Column	402
Overdrive KickDown	531	Pedal(s)	152-156	Brake Pedal Cross Shaft Nylon	467, 524
Power Brake Booster	460	Proportioning Valves.....	459	Carburetor Linkage Grommet.....	315
Power Brake Hose	465	Rotor	458, 466	Clutch Pedal Shaft	524
Power Steering.....	412-413, 415	Shoes	466	Clutch Cross Shaft	525
Hose Grommet Frame	419	Guide Plate.....	466	Covers, Body Mount	605
Ram Cylinder Bolts.....	420	Lever, Emergency	472	Door Hinge	617
Proportioning Valve	459	Return Springs.....	466	End Link	437
Quarter Glass, Rear,	647	Third Lights & Related.....	68	Idle Arm & Related	423
Radiator Conversion	384	Vacuum Hose Clamps.....	465	Leaf Spring Front.....	433
Radiator Splash Pan Center		Wheel Cylinders.....	466	Shift Column Lever Linkage	407, 523
Support	541	Wilwood Disc Kits	454-457	Shift Linkage Bell Crank	524
Rear End Snubber.....	583	Bras.....	691	Sleeve, Generator Mount.....	241
Retainers, Front Seat.....	133	Brass Brake Junction Blocks.....	469	Spring Shackles	431
Rivets, Pivot	642	Brass Carburetor Vent Tubes	316	Sway Bar Mounting	436
Screws, Emergency Brake	473	Brass Exhaust Manifold Nut.....	356	Turn Signal.....	401
Seat Adapter	141	Brass Wire Tie	308	Button	
Seat Floor	563	Breather Caps & Related	298-299	Horn	392, 395
Seat Riser	177	Brushes, Starter	242	Radio, Push.....	92, 254
Seat Shell/Forward Stop.....	134	Bucket(s)		Silver Seat.....	133
Shift Indicator Spring	83	Headlight	69	Switches, Power Window.....	624
Slider Glass Lock	647	Seats & Related	140-141	Bypass Valve Kit, Oil Filter.....	499
Slider, Window Fur Channel	646	Buff Balls, Flitz.....	678		
Snubber, Rear End.....	429	Bug Screen, Radiator	384		
Starter	242	Bulbs, Light	82		
Steering Column	407	Headlight	73		
Studs, Fuel Filter	346	Bullets, Bumper	50		
Sunvisor Support	127	Bumper(s)			
Tailgate Bumper.....	654	4-Door Rubber.....	619		

C		
Cab Mounts.....	492	
Cable		
Antenna.....	260	
Air Vent Assembly & Related.....	370	
Balls, Nomad/Wagon.....	653	
Battery & Related.....	237	
Bracket, E-Stop.....	472	
Brackets, Throttle.....	320	
Brake.....	471	
Choke, Universal.....	322	
Clips, Emergency Brake.....	472	
Clips, Heater & Related.....	364	
Crimp Tool.....	237	
Cruise Control.....	252	
Emergency Brake.....	473	
Extension Kit,		
Transmission or Throttle.....	514	
Firewall Grommet.....	282	
Fresh Air Vent Control.....	370	
Guides, Nomad & Wagon.....	653	
Heater.....	364	
Kickdown.....	532	
Lokar Throttle.....	318	
Retainer, Wiper Motor.....	634	
Speedometer.....	522	
Grommet.....	280, 282	
Tailgate & Tailgate Retractor.....	653	
Throttle.....	318, 530	
Bracket.....	320	
Tool, Wiper Control.....	631	
Universal Parking Brake.....	470	
Vent, Screw and Washer Kit.....	371	
Wiper Switch Control.....	633	
Calibration Carburetor.....	340	
California Car Cover.....	676-677	
California Transmissions.....	513	
Torque Converters.....	515	
Caliper, & Brake Grease.....	680	
Calipers, Front.....	458	
Cam Pack Kit, Power Steering Pump.....	416	
Canceling Cams, Turn Signal.....	401	
Canister		
Vacuum Advance.....	269	
Vacuum Advance, Pertronix.....	272	
Cap(s)		
A-Arm Bushing.....	426	
American Racing Center.....	480	
Ball Joint.....	428	
Brake Master Cylinder Gasket.....	464	
Breather.....	298-299	
Center, American Racing.....	479	
Choke Cover.....	322	
Cragar Center.....	481	
Distributor, Pertronix & Rotors.....	272	
Emblems, Horn.....	97, 398	
Flare.....	301	
Gas.....	309	
Grease Hub.....	478	
Horn.....	97, 398	
Ring Center.....	96, 398-399	
Master Cylinder.....	464	
MSD.....	267	
Oil & Related.....	298	
Pertronix Distributor and Rotors.....	272	
Power Steering Pump Reservoir.....	416	
Radiator.....	388	
Cold Case.....	377	
Rally Wheel Center.....	478	
Red Stripe Locking Gas.....	309	
Ribbed Lock.....	613	
Seat, Rear, Lower.....	135	
Vent Window Frame.....	642	
Window Pillar Spacer.....	627	
Car Care.....	371, 644, 673-694	
Danchuk Vintage.....	674-675	
Car Cover.....	690-691	
Car Duster.....	676	
Car Hop Tray.....	704	
Carburetor(s).....	315, 332-333	
Adapters & Related.....	339	
Air Cleaner Rods.....	317	
Base Gasket.....	317, 338	
Book.....	670	
Calibration.....	340	
Choke Cover.....	322	
Choke Housings.....	316	
Choke Tube Heat Kit.....	321	
Cleaner.....	683	
Clips.....	317	
Edelbrock.....	336-337	
Ends, Lokar.....	318	
Fittings, Russell Performance.....	301	
Fuel Filter Fittings, Bowl-to.....	315	
Gaskets.....	316, 323, 328, 339	
Grommet.....	324	
Intake Manifold.....	334	
Insulator & Gasket.....	317	
Kits.....	338	
Linkage.....	315	
Bracket.....	325	
Metering Rods and Jet.....	315	
Mounted Linkage Brackets.....	315	
Pump Adapters.....	301	
Rebuilding Kits.....	315, 339	
Return Springs.....	317	
Screw Sets.....	317	
Spacer Blocks.....	316	
Stud Kits.....	317	
Throttle Cable Brackets.....	318	
Vent Tubes.....	316	
Cardboard Panels.....	162-164	
Upholstered.....	182-183	
Cargo		
Access Cover.....	648	
Area Assembly Kit.....	147, 648	
Area Light Switch with Bezel.....	80	
Floor & Related.....	595	
Shock Supports.....	579	
Insulation Kits.....	158	
Seat Trim.....	172	
Shock Supports.....	579	
Stainless Trim.....	170-174	
Trim Kits.....	171	
Wagon.....	174	
Carpets.....	227-232	
Floor Mats.....	149	
TMI.....	187	
Trunk Mats.....	166	
Carrier Assembly, Continental Kit.....	58	
Caulk Strips.....	677	
Center		
Bars, Tailgate.....	55	
Cap, Horn Ring.....	96	
Bel Air.....	399	
Screws.....	398	
Cap, American Racing.....	479	
Cap, Cragar.....	481	
Cap, Rally Wheel.....	478	
Connector Mouldings, Windshield.....	630	
Cross Bows.....	175	
Drive Gaskets, Wiper.....	634	
Floor Braces.....	574-575	
Floor Section, Trunk.....	579	
Panel, Transmission.....	576	
Pillar, Convertible Windshield.....	601	
Post Cardboard.....	163	
Post Mouldings.....	45	
Reinforcements, Rear Floor.....	580	
Centerlink & Related.....	420-421	
Centering Kit, Gas Tank.....	306	
Chain, Timing & Related.....	495	
Channel(s)		
Clips, Nomad Slider.....	647	
Convertible Drain.....	600	
Division Bar, Stops.....	634	
Fur Kits & Related.....	626	
Glass Settings.....	635	
Locating Clips, Nomad Slider.....	647	
Mouldings, Interior Pillar Weather.....	631	
Screws, Flipper/Rear Window.....	618	
Slider Brackets, Window Fur.....	646	
Stops, Division Bar.....	634	
Vent Delete Window Kit.....	641	
Wire, Upper Door Hinge.....	617, 624	
Window Adjusting Seals.....	627	
Window Gasket.....	592	
Windshield Gasket, Bottom.....	629, 636	
Charger, Battery Butler Float.....	236	
Chassis, Morrison.....	444-445	
Chevrolet		
Novelties.....	699-706	
Scripts.....	20, 91, 102	
Manuals.....	661	
Choke		
Carburetor & Related.....	316, 321-322	
Covers Cap & Cap.....	322	
Edelbrock Electric.....	343	
Cigarette Lighters.....	93	
Cirkit Boss, Auxiliary Fuse Blocks.....	239	
Clamp(s)		
Brake Vacuum Hoses.....	465	
Distributor.....	264	
Hold-Down.....	267	
Exhaust.....	355-359	
Gas Tank Filler Pipe Hose.....	308	
Heater Hose.....	368	
Line.....	313	
Notched Braided Line.....	448	
Notched Line Kits.....	475, 693	
Radiator Hose.....	386	
Rubberized Kit.....	467	
Valve Cover Hold Down.....	297	
Classic Instruments.....	110-115	
Fuel Gauge.....	311	
Speedo Sender.....	253	
Classic Performance		
Dropped Spindles, Modular.....	458	
Suspension Package.....	425	
Sway Bar Kits.....	438-439	
Tubular Traction Bars.....	428	
Clayton Machine Works Pedal Pads.....	152	
Cleaner, Air & Related.....	317, 326-328	
Fuel Injection Bracket.....	348	
Clevis, Emergency Brake.....	471, 473	
Clip(s)		
Back-Up Lens Retaining.....	78	
Brake Hose to Mounting Bracket.....	468	

Brake Line	474-475	Clutch		Book, EFI	670
Brake Line Frame	468	Covers, Air Conditioning	390	Brackets, Motor Mount	490
Carburetor	317	Fork	526	Brackets, Radiator	384
Convertible Top Switch Retaining	179	Frame Brackets	525	Brake Kits	448-451, 460-461
Dash Moulding	94	Head Screwdrivers	371	Hose	468
Door Garnish	147, 620	Linkage Spring, Anti-Rattle	526	Pedal	152
Door Glass Moulding	625	Pedal(s) & Related	152-156, 525-527	Coil Over Shock	436
Door Latch and Lock	614-615	Release Bearing	525	Digi-Tails	66
Door Panel	146-147, 164, 619	Shaft Related	525	Engine Side Mount Kit	491-492
Trim Joiner	620	Coat Hooks	124	Ignition	270
Door Window Upper Moulding	620	Coil(s)		LED Dome Light Housing	80
Emergency Brake Cable	472	Bracket & Related	264, 268	LED Taillight	67
Fender Terminal Block	248	Cover Kits	264	Motor Mount	492
Fender Wire Harness	280, 291, 549	MSD	348	PCV Valve Kit	297
Fin Corner Retaining	45	Ignition	264	Parklight & Related	77
Firewall Pad Metal Push-in	95	Ignition, Pertronix	270	Plates, Back-Up Light	78
Firewall Seal Retainer	95, 278, 403	MSD & Related	268	Plugs, Alternator	246
Firewall to Hood Seal	280	Over Related	436-437	Power Door Lock Kit	621
Front Seat Floor	133	Speaker	255	Power Steering Kit	411
Garnish Moulding	148	Springs	434	Power Window Kit	623
Gas & Brake Line	311	Cold Case Radiators	376-377	Power Steering Pump Fitting	416
Grille and Screw Set	29	Collars, Steering Column Shift	402	Power Window	623
Grille Bar Harness to Inner Fender	29	Collector Gaskets	358	Rack and Pinion	411
Grille Bar Pin	28	Color Accessory Booklets	660	Radiator	379-380
Handle	611	Column(s)		Rear End Kit	430
Heater Cable	364	Lever Linkage Bushing	407, 523	Roller Bearing	422, 476
Heater Control Cable Retainer	364	Mounted Shift Indicator Lenses	83, 99	Side Mount	491
Horn Wire to Inner Fender	291	Shift Linkage Arm Kit, Adjustable	523	Spin-On Oil Filter Kit	499
Hubcap Retainer	479	Steering & Related	400-411	Steering Box Hose Kit	409
Inner Fender Terminal Block	248	Commander Keyless Entry	621	Transmission Side Mount Kit	511
Liftgate Retainer	649	Compass Bracket	125	Valve	297
Linkage Rod	325	Compressor, A/C Related	390	Converter, Speedometer	522
Lock Cylinder Pawl	613	Brackets, Billet Specialties	504	Converter, Torque	515
Moulding, Paint Dividers	37	Brackets, Bill's Hot Rods	507	Convertible	175-181
Moulding, Sets	59	Condenser, A/C & Related	388-389	Armrest and Piston Cover	601
Moulding, Side Window	625	Conduit, Power Window Wire	624	B-Pillar Related	559
Nomad Tailgate	55, 651	Connector(s)		Backrest Support & Related	600
Nomad Window	647	4-Way	275	Body Adjustments Guide	663
Radiator Support Wire Harness	384	Grille Bar Wiring	28	Drain Channels	600
Radio Speaker Grille	89	Grommet Set	248	Reinforcements	601
Rear Quarter Upper Window	625	Firewall Harness	278	Floor with Braces	568
Rear Window Moulding	625	Headlight Switch	274	Floor Pans	577
Removal Tool, Hand	611	Kickdown	531	Frame Bolt Set	181
Retainer Curved Quarter Glass	638	Moulding	625	Frame Rail Skid Plates	601
Rocker Panel Moulding	35	Windshield and Rear Window	630	Front Header Bow	175
Shift Linkage Retaining	524	Torque Lock-Up Switch	515	Inner Quarter Garnish Trim	181
Side Moulding	60	Window Moulding	59	Latch Plates	178
Slider Glass Channel Locating	647	Windshield Center Moulding	630	Mirror Support	180
Tailgate Rod	651	Wiring	249	Pinch Rail Pads	180
Taillight Housing Wire	67	Continental Kit & Related	58	Pinchweld Moulding Set	181
Top of Fin Moulding	44	Control(s)		Quarter Beltline Mouldings	45
Transmission Oil Cooler Line	517	Cable Assembly, Wiper Switch	631	Quarter Panels	585, 587
Trunk Wire Harness	167	Cables, Air Vent	370	Rear Quarter Pivot Assembly	
Universal Moulding	59	Cruise, Kits & Related	252	Hardware	179
Windshield Moulding	630	Electric Fan	249	Seat Back Brace Panel	562
Clock(s)	102, 113-114	Heater Related	362-365	Seat Floor Bracket	563
Analog	119	Lens, Heater	84, 98	Seat Frame	137
Auto Meter	106	Ignition	269	Sunvisor & Related	127, 180
Bezel	101, 106	Kit, Electric Fan	374	Top & Related	600
Dakota Digital	116-120	Knobs, Radio	92	Boot Bag	179
Dash Script	91, 102	Throttle	156, 320	Boot Retainer	178
Delete Panels & Related	89	Valve Kits		Boot Snaps	179
Digital	119	Power Steering Pump	417, 419	Bow Assembly	175
Housing, Billet	89	Controllers, Transmission	514	Cross Bow	175
Quartz	102	Controllers, Fan	374-375	Cylinder Braces	178
Retainer Bracket	102	Conversion(s)		Cylinder Brackets	176
with Bezels	101-102	Air Cleaner	328	Divider Strip	178
Cluster, Instrument & Related	99-101	Alternator Bracket Kit	245	Footman Loop	178

Header Bow	175
Hose Assemblies	176
Latch Assembly	178
Latch Down Handle Assembly	178
Latch Plates	178
Latch Screws	178
Lift Cylinders	176
Motor	176
Motor Grommet	280, 283
Pivot Bracket	176
Straps	179
Striker Plates	178
Switches Assembly	179
Switch Bracket	179
Switch Retaining Clips	179
Switch Shaft and Knob	179
Tack Strips	178
Weatherstrip	181
Trunk Lid Hinge Assembly	179
Support Braces	583
Wheel Housings	599
Wheel Well to Quarter Support	601
Window to Trunk Brace	579
Windshield Center Pillar	601
Windshield Frame	600
Moulding Hardware	180
X-Frame Assembly	600
Rear Window Brace	591
Coolant	
Boost by Amsoil	687
Evans Waterless	385, 681
Overflow Tank	386
Cooler(s), Transmission Related	517-519
Cooling Modules, Hot Rods by Dean	383
Copper Master Cylinder Washers	464
Core Support, Radiator	384, 542-544
Core, Heater & Related	362-363
Couplers, Hose	300-301
Cover(s)	
A/C Clutch & Compressor	390
Accelerator Pedal	152-157
Access Hole, Doors & Windows	619
Back-Up Light & Related	79-78
Ballast Resistor	263, 283
Body Mount Bushing	605
Brake Pedal	153
Brake Drum Hole	467
Breather	299
Car & Lock Kit	690-691
Carburetor Choke	322
Cargo Area Access	648
Choke	322
Coil Kits, MSD	348
Cowl Brace	283
Cruise Control Handle	252
Dash	691
Dimmer Switch	157, 276
Dome Light Switch	80
Dust	513
Firewall	552
Flipper Lever	618
Flywheel Dust	526
Fresh Air Vent	370
Gauge	120
Heater Blower Hole	366
Horn	291
LeCarra	392
Coil, Ignition	264
Light Bulb	82
Lower Bell Housing	526
Master Cylinder	464
Radiator	385
Rear End, Perfect Launch	432
Seat Frame, Lower Corner	135
Seat Latch	174
Shock, Nomad & Wagon	174
Spare Tire	691
Well	596
Speaker & Related	88-89
Speedometer	293
Steering Box	402
Steering Column, Bracket	407
Tailgate	174
Access	654
Ball	653
Hinge	650
Inner	171
Striker	652
Tensioner	505
Timing Chain & Related	495
Transmission Inspection Plate	515
Under Trunk or Hood Lid	158
Vacuum Advance	269
Valve & Related	292-298
Wheel	479
Spinner	477
Wire Harness Door Sill	143, 565
Cowl	
A-Pillar Panels & Related	558-559
Brace Cover with Cap Nuts	283
Brackets	548
Drain Seals	630
Fender Bracket Washers	283
Floor Braces	574
Panels	554-555
Sides	
Drain Gutters	619
Extension Hingemounts	555
Outer	555
Panels	555
Tag Rivets	283
to Fender Mount Brackets	556
Top Outer Corner Rubber Bumpers	283
Vent Grommets & Screws	283
Vent Screws	283
Cragar Wheels	481
Crank	
Bushing, Shift Linkage	524
Gear Installation Tool	500
Handles, Vent & Window	609
Pulleys	501
Turning Socket Tools	501
Crankshaft Pulleys & Bolts	501
Crate Engines	486-488
CRC Brake Products	680-682
Crest Emblems	19
Crimp Tool	237, 266, 268
Cross Members	
Brake Line Clip	474
Transmission & Related	512
Shock	435
Cross Shaft, Clutch & Related	524
Cruise Control & Related	252
Cups, Armrest Finger	129
Cups, Auto Meter Gauge Mounting	109
Cushion(s)	
A-Arm	427
License Plate	57
Motor Mount Rubber	491
Radiator Core Support Rubber	384
Seat Moulding	134
Steering Column-to-Dash	401
Trunk Lid to License Plate	57
Motor Mount	491
Custom Trunk Panel	163
Custom Autosound	256-260
Cylinder	
Brake Master & Related	462-465
Wilwood	456
Brake Wheel	466
Convertible Top Lift	
& Related	176-178, 600
French Lockwasher, Wheel	467
Heads	340-341
Ignition Lock & Related	262-263
Lock Pawl Clips	613
Power Steering Ram & Related	420
Push Pins, Wheel	467
D	
Dakota Digital	
Dash & Related	118-121
Door Actuators, Keyless Entry	621
Speedometer Interface	253
Dampers, Harmonic,	
Professional Products	500
Danchuk	
Bandana	703
Key Fob	705
Sign, Metal	707
Signature Series Gauges	110, 112
Tee Shirts	696-698
Vintage Car Care System	674-675
Dash	
Bezel Set	88, 90
Chrome Ring	90
Cover	691
Custom Scripts	23
End Caps	94
Garnish Trim	147, 628
Gauges	
Auto Meter	104-109
Classic Instruments	110-115
Dakota Digital	116-121
Original	103
Gauge Covers	120
Indicator Lenses	83, 98
Instruments, Dakota Digital	118
Knobs	88, 91
Lenses	84, 98
Moulding Clip	94
Mounted Cruise Control Switch	252
Pad	94
Panel	554
Panel Inserts	107
Script	
Bel Air	91
Chevrolet	91
Clock	91, 102
Speaker Assembly	92
Trim Sets	86, 88
Vents, A/C	91

Dashboard	Dividers, Paint & Related	Gutters, Cowl Side
Fasteners	Filler Trim	Plug Kit
Day/Night Rear View Mirrors	Division Bar Channel Stop	Plug, Rear End
Decal(s)	Dolly, Auto	Plug, Oil Pan
Bumper End Insert, Rear	Dome Lens & Related	Rear Glass Seals
Hubcap	Doors & Related	Rear Quarter
Odometer Number	Access Hole Covers, Plugs, Screws	Seals
Paint Divider	Actuators	Lower Door
Deck Handle Gaskets	Adjust Plate	Window Gutter Inner
Deck Lid Moulding Kit	Attaching Strip	Dress Up Kits
Defroster Seal, Heater	Belt Mouldings & Related	Idiot Steering Column
Degreasers, Engine	Bolts, Door Hinge to	Drip Rails
Delay Switch, Intermittent	Bottoms	Drive
Delco-Remy Detail Tags	Box Inside Quarter Panel, Fuel	Gaskets, Windshield Wiper Center
Delete Window Channel Kits, Vent	Drain Seals	Shaft Yokes
Derale Transmission Coolers	Filler Bracket, Gas	Shaft, Oil Pump
Desert Cooler Radiators	Flippers & Related	Dropped Spindles
Detail Tags	Frames	Drums, Brake & Related
Delco Remy	Garnish Clips, Interior	Duct
Detailing Products	Gas, Accessory Guard	Air Drain Tube
Detent, Shift	Gas, Springs, Screws & Bumpers	Cable Retainers
Detent Slide Bumper	Glove Box	Fresh Air, In Fender
Detents, Powerglide Shift	Handle(s)	RealDuction Air Block-Off
Diagrams, Color Wiring	Assemblies	RealDuction Firewall Block-Off
Diagrams, Passenger Car Wiring	Gaskets	Dust
Dice, Fuzzy	Reinforcements	Cover
Differential(s) & Related	Release Mechanism	Shields, A-Arm Related
Additive, Amsoil	Hinges & Related	Taillight
Book, How-to Rebuild	Seals with Clips	Flywheel Cover
Pinion Seal	Jams & Related	Dynamat Noise Reduction
Digi-Tail Conversion Kits	Patch Panels	
Dimmer	Reinforcements	
LED Light	Latch Assemblies & Related	
Switches & Related	Lock	
Mount Plate	Knobs	
Dimming Kit	Mechanism Screw Set	
Dipstick(s)	Rod Assembly w/ Clips	
Engine & Transmission	Retainers	
Flexible & Hi-Tech Engine	Moulding Clip Sets	
Milodon Oil Pan	Nomad	
Transmission & Related	Panel(s)	
Tube, Oil	Cardboard & Plastic	
Direct Fit Pedals	Attaching Strip	
Disc Brake	Clip and Nail Set	
Calipers	Metal Bands	
Conversion Kits	Retainers, Rear Seat	
Master Cylinders	Trim Kits, Interior	
Wilwood Brake	Pillar Lower Patch Panels	
Wheels	Post Striker Plates	
Disconnect	Pulls	
Switch & Related	Release Mechanism, Interior	
Universal Gauge	Rubber Bumpers & Related	
EFI Fittings	Screws	
Dispensers, Tissue	Seals	
Distributor(s)	Sill Covers, Wire Harness	
Advance Curve Kit	Sill Plates	
Cap and Rotors	Skins	
Pertronix	Stop Kit, Gas	
Clamp	Striker & Related	
Hold-Down	Trim Kits	
Clamp	Trim, Nomad	
Studs	Torsion Bars	
MSD	Weatherstrip Retainers & Screws	
Pertronix	Dots, Blue w/ Bow Tie Emblems	
Flamethrower Billet	Dots, Glass	
Replacement Modules	Doug's Headers	
Tag Fastener Set	Drain	
Vacuum Advance	Air Inlet Tube Grommets	
Vacuum Lines	Channels, Convertible	
Wire Grommet		

E

E-Stop Emergency Brake	472
Eddie Motorsports	169, 508
Battery Boxes	235
Hood & Trunk Hinges	286
Hood Braces & Supports	287
Hood Latch Plates	290
Sill Plates	143
Edelbrock	
Air Cleaner	326
Carburetors & Related	334-339, 344
Cylinder Heads	340-341
Electric Choke Kit	343
Engines	486-488
Fuel Filters	342
Fuel Lines	342
Fuel Log Kit	340
Fuel Pressure Regulator	344
Fuel System	346
Gaskets	339
Hose Kits	342
Intake Manifolds & Gaskets	334-336
& Carb Kits	338
Gaskets	337
Pumps	343
Step Up Spring Assist	339-340
Throttle Solenoid	340
Top End Kits	489
Universal Choke Cable Kit	322
Universal Plug Wires	273
Valve Covers	292
Water Pumps	503
EFI Fuel Systems & Related	
Bypass Regulator	332
Carb Fittings	333
Disconnect Fittings	344
Edelbrock	345-346

Gas Install Kit.....	305	Cowl Side Hinge Mounts.....	555	Fuel.....	342
MSD.....	347-348	Fender.....	47	Element & Fittings, Fuel.....	314-315
Regulators.....	333	Hood Bar.....	32-33	Fuel & Related.....	331-332
Elbows.....	300	Lower Fender.....	548	Regulator, LS Engine.....	344
Electric		Spare Tire Well.....	596	Gas Tank Sending Unit.....	311
Antenna, Rear.....	260	Transmission or Throttle Cable Kit.....	514	Glass Bowl Fuel.....	314
Choke Kit, Edelbrock.....	343	Wheel Related.....	597-598	Oil Related.....	498-499
Exhaust Cutout Kits.....	355			Fin, Top of Moulding & Related.....	44-45
Fans & Related.....	249, 373-375			Finger Cup, Armrest.....	129
Cold Case.....	377			Fire Extinguisher.....	123
Kickdown Kit.....	531	F		Firewall.....	552-553
Wiper Motors & Related.....	632	Face Plate, Continental Kit.....	58	Cable Grommets.....	282
Electro-Vac Tag.....	671	Factory Fit Wiring Harnesses.....	251	Covers.....	552
Element		Fan		Grommet.....	264
Fuel Filter.....	314, 342	Adjustable Thermostat.....	368	Installation Tool.....	95
Aeromotive Replacement.....	331	Alternator Pulley.....	246	Mount Plate.....	403
Oil Filter.....	499	Belts.....	502	Pad & Related.....	95
Emblem(s)		Cold Case.....	377	Panel, Replacement.....	278, 553
Crest.....	19	Control Kits, Electric.....	249, 374	Plates & Related.....	279
Custom.....	23	Controller.....	374	Seal Retainer Clips.....	95, 278, 403
Displacement Number.....	23	Electric.....	373-375	Smoothie.....	278
Fuel Injection Flags.....	22	Flex.....	374	to Hood Seal Clip Sets.....	280
Grille Bar Installation Kit.....	28	Mounting Brackets.....	373	Wire Harness Grommet.....	282
Hood.....	18-19	Relay Kit, Electric.....	374	Fitting(s)	
Horn Cap.....	97, 398	Shrouds.....	372, 377	Aeromotive Carb & Regulator.....	331, 333
Spinner.....	22	Spacers.....	374	Banjo Carb.....	340
Trunk.....	18-19	Fan-Thom II Electric Fan Control Kit.....	374	Banjo Pressure.....	416
Under Taillight V8.....	22	Fastener(s)		Conversion.....	416
Emergency Brake & Related.....	470-473	Accessory.....	489	Cooler Derale.....	519
Handles.....	123	Dashboard.....	94	Pressure Reduction.....	416
End(s)		Distributor Tag.....	241	Banjo Pressure.....	416
Bumper.....	53	Engine.....	489	Bowl to Carb Fuel Filter.....	315
Front, Rebuild Kits.....	424	Front End Sheet Metal.....	604	EFI Quick Disconnect.....	344
Hose.....	300-301	Generator.....	241	Flare Fittings.....	300-301
Billet Specialities.....	299	Heater Assembly.....	362	Heater Hose.....	367
Link Bushings.....	437	Starter.....	241	Intake Manifold.....	322, 368
Rear.....	429-432	Steering Column Assembly.....	403	Heater Hose.....	368
Stop, Windlace.....	148	Tailgate.....	654	Master Cylinder.....	465
Tie Rod.....	424	Winged Speed Nut.....	59	Oil Pressure Sender.....	115
Top Kits.....	489	Felt Floor Seal.....	402	Power Steering O-Box.....	419
Energy Suspension Motor Mounts.....	492	Fender(s).....	534-535, 547-548	Russell Performance.....	300-301
Engine(s).....	486-488	Antenna Plug.....	283	Transmission Oil Cooler Line.....	517
Adapter Brackets.....	490	Anti-Squeak Gasket Kits.....	551, 606	Vacuum Hose.....	322
Books.....	666	Brace to Grille Bar Support.....	549	Water Pump.....	503-504
Covers, AVS SpeedCovers.....	293	Brackets & Braces.....	550, 589	Flags, Fuel Injection Emblem.....	22
Degreasers.....	682	Clips.....	291	Flaming River	
Dipsticks.....	493-494	Extensions, Lower.....	548	Steering Wheels & Related.....	392
Displacement Number Emblems.....	23	Fenders, Inner.....	549	Steering Columns & Related.....	408
Dress Up Kit.....	295-296	Louvers.....	47	Flange	
Fastener Kits by ARP.....	489	Patch Panels, Lower, Front, Rear.....	550	Exhaust.....	359
Ground Strap.....	239	Patch Panels, Headlight.....	540	Gaskets, Exhaust Manifold.....	356
Install Kits.....	490	Reinforcement, Front Corner.....	548-549	Seal, Axle.....	431
Sender Adapter Kit.....	104	Retainer.....	364, 545	Windshield, Cowl Panels.....	554
Side Mount Conversion Kits.....	491	Seals.....	550-551, 606	Flare Fittings.....	300-301
Stand Axle Adapter.....	694	Skirt Brackets.....	551	Flashers	
Starter Plate.....	522	Skirts with Brackets & Scuff Pads.....	551	LED.....	66
Escutcheon(s)		Support Brackets.....	548, 550	Steering Column Harness.....	408
Nut Tool, Wiper.....	631	Terminal Block Clip.....	248	Turn Signal.....	275
Seat Adjuster.....	134	to Cowl Bracket.....	548	Flexplates and Related.....	488
Windshield Wiper.....	631	Wire Harness Clips.....	291, 549	Flipper(s), Door & Related.....	618-619
Evans Waterless Coolant.....	385, 681	Filler		Float, Gas Tank Sending Unit.....	311
Exhaust.....	349, 353	Bracket, Gas Door.....	314	Floor	
Hardware.....	356-358	Neck & Check Valve Kit, Gas.....	308	Braces.....	574-575
Headers Kits, Magnaflow.....	353	Panels.....	541	Cargo.....	595
Manifold(s) & Related.....	354-359	Radiator Core Support Side.....	544	Extension.....	595
Wraps, Thermo-Tec.....	360	Pipe Hose Clamps, Gas Tank.....	308	Center Reinforcements.....	580
Extension(s)		Tubes, Fuel Tank.....	308-309	Complete.....	568-569
Exhaust.....	357	Tubes, Oil.....	499	Flip Screws.....	133
Cargo Floor.....	595	Filter(s)		Full Trunk.....	571, 579
		Adapter.....	499	Insulation Kit.....	158

Mats.....	149-151, 165	Pushrods.....	313	Channel, Rear Window.....	592
Pans and Related.....	570, 576-577	Relay Kit, Weatherproof.....	249	Channel, Windshield.....	629
Plug.....	604	Sender, Universal.....	107	Collector Malleable Aluminum.....	358
Plate, Trunk.....	579	Sender, Wire Grommets.....	81	Cylinder Head, Edelbrock.....	340
Pocket, Seat.....	563	Systems, Aeromotive.....	331	Deck Handle.....	608
Reinforcements, Rear.....	576	Systems, Edelbrock.....	346	Dome Light Switches and.....	274
Seat Supports, Rear.....	576	Systems, EFI & Related, MSD ...	347-348	Door Handle.....	608
Shock Supports.....	579	Tanks.....	305	Door Handles.....	55
to Cowl Braces.....	574	Transfer Hose.....	308	Exhaust Heat Riser.....	355
Trunk Sections.....	572-573, 579	Fur Channel.....		Exhaust Manifold Flange.....	356
Flowmaster Exhaust & Related.....	355	Kits, Window.....	626	Gas Tank Sending Unit.....	311
Fluids.....		Screws.....	618	Header, Aluminum.....	358
Brake, Wilwood.....	457	Slider Brackets, Window.....	646	Heat Insulator Carb Bore.....	339
Steering.....	687	Tracks.....	626	Hood Bird.....	34
Transmission.....	681	Fuse & Related.....	240	Instrument Cluster.....	99
Flywheel & Related.....	488, 526	Circuit Boss Auxiliary.....	239	Intake Manifold.....	323, 357
Foot Man Loop, Convertible Top.....	178	Fuzzy Dice.....	705	Edelbrock.....	337
Ford, 9-Inch Posi-Rear Ends.....	429			Lens.....	65, 79
Fork, Clutch.....	526			License Lens.....	81
Frame(s).....				Lower Thermostat Housing.....	369
Brake Line Clips.....	468	G		Makers.....	684-685
Bracket Rivets.....	642	Garnish.....		Master Cylinder Cap.....	464
Bolt Set.....	181	Clips, Interior Door.....	147, 620	Master Cylinder to Firewall.....	464
Brackets, Clutch.....	525	Interior Windlace for Nomad ...	148, 647	Oil Pan.....	497-498
Door Window.....	628	Mouldings.....	45,145-146	Paint.....	608
License Plate.....	56-57	Trim, Inner Quarter.....	181	Rear End Center Section	
Mount Brake Pedal/		Trim, Windshield to Dash.....	147, 628	to Housing.....	432
Master Cylinder Bracket.....	464	Gas, also see Fuel.....		Sealer, Gasaginch.....	684
Quarter Window.....	639	Bilstein Shock Absorbers.....	435	Trico Vacuum Wiper Motor.....	633
Rail Skid Plates, Convertible.....	601	Caps.....	309	Under Taillight.....	67
Screws, Liftgate Window.....	648	Door.....		Valve Cover.....	297
Vent Window.....	640-642	Filler Bracket.....	314	Wagon Tailgate.....	55
Fresh Air Vent & Related.....	370-371	Guard, Accessory.....	37	Windshield Wiper Center Drive.....	634
Front End.....		Rubber Bumpers.....	314	Gasser Body.....	
& Steering Rebuild Kit.....	424	Springs.....	314	Wheel Well Opening Patch Panels.....	588
Sheet Metal Fasteners.....	604	Stop Kit.....	314	Gauge(s).....	103-121
Sheet Metal Packages.....	534-535	Filler Neck & Check Valve Kit.....	308	Adapter Kit.....	108
Front Runner Drive Systems.....	505	Liftgate Strut Kit.....	649	Auto Meter.....	104-109
Fuel, See also Gas.....		Lines & Related.....	311-313	Classic Instruments.....	110-115
Door Box Inside Quarter Panel.....	314	Pedals and Related.....	152-157	Dakota Digital.....	116-121
Filter(s).....		Pressure Gauge.....	107	Disconnect Kit, Universal.....	102
Aeromotive.....	331	Springs, Hood Hinge.....	285	Fuel Pressure.....	107, 115, 332
Edelbrock.....	342	Tank(s) & Related.....	304-312	Mounting Cups & Panels.....	109
Element.....	314	Centering Kit.....	306	Oil Pressure.....	114
Fitting.....	315	Filler and Vent Hose Kit.....	308	Original Reproductions.....	103
Glass Bowl.....	314	Filler Tube & "O" Ring.....	308	Water Temperature.....	114
Gauges.....	115, 311, 332	Locator Kit.....	307	Wiring Kit, Dakota Digital.....	120
Injection.....	305, 346	Mounting Straps.....	307	Gear(s).....	
Flags Emblem.....	22	Bolts.....	306	Plate, Window Regulator.....	622
Fuel Module, Replacement.....	346	Pipe Support Bracket.....	308	Shift Arm & Related.....	399
Gas Tank.....	305	Screws.....	311	Shift Arm Pin & Grommet.....	400
Gaskets.....	323	Filler Pipe Hose Clamps.....	308	Shift Knob.....	399
Harnesses.....	248, 348	Filler Tubes.....	309	Shift Lever Spring.....	401
Ignition Wires.....	265	Mount.....	307	Speedometer.....	522
Script.....	22	Sending Unit & Related.....	310-311	Generator & Related.....	241, 415
Vent Line.....	348	Strap Anchor Bracket Kit.....	308	Glass(es).....	655-658
Wire Harness.....	348	to Body Grommet.....	308	Bowl Fuel Filters.....	314
Lines, Edelbrock.....	342	Universal, Sender.....	107	Brackets, Rear Quarter.....	647
Log Kit, Edelbrock.....	340	Gasaginch Gasket Sealer.....	684	Channel Locating Clips, Slider.....	647
Nipple.....	322	Gasket(s).....		Clips.....	625
Pressure Gauge.....	107	6-Cylinder Set.....	297	Dots.....	75
Pressure Regulator.....	344	Air Cleaner to Carburetor.....	328	Drain Seals.....	635
Pump(s) & Related.....	313, 329-330	Anti-Squeak, Fender & Hood.....	551	Lock Bracket, Slider.....	647
Aeromotive.....	330	Channel, Windshield, Bottom.....	629	Metal Channels.....	635
Block Off Plate.....	313	Air Cleaner to Carburetor.....	328	Mouldings.....	635
Bolt.....	313	Air Horn.....	317	Mouldings, Stationary.....	628
Edelbrock.....	343	Anti-Squeak, Hood & Fender ...	551, 606	Mouldings, Vertical Slider.....	646
Fuel Injection.....	305, 346	Carburetor Base.....	317	Reflectors.....	75
MSD.....	348	Edelbrock.....	338	Retainer Clips, Curved Quarter.....	638
		Carburetor Insulator.....	317	Run Channels.....	635

Seals, Quarter & Side	643
Slider Latches	647
Tracks & Related, Quarter	636
Window Stop Kit	637
Glove Box & Related	122-123
Lock Set	613
Switch	275
GPS SkyDrive Antenna	253
GPS Speedometer Interface	
Module	121, 253
Gravel Shields	35
Grease	
Di-Electric	680, 683
Hub Caps	478
Grille(s)	24-27
Bar	
Assembly	28
Emblems	19
Installation Kit	28
Harness to Inner Fender Clip	29
Support Brackets	28
To Fender Brace	549
Pin Clip Set	28
Winged Speed Nuts	29
Wiring Connector	248
Bolt Set, Fake Rivet Head	30
Clips & Screws	29
Cover, Speaker	89
Custom	27
Moulding, Lower	27
Speaker	256
Tie Support Bars & Related	31
Grommet(s)	
Accelerator Pedal	157
Air Inlet Drain Tube	371
Carburetor	315, 324
Convertible Top Motor	283
Cowl Vent	283
Dimmer Switch	157
Distributor Wire	264, 282
Dome Light Lens Harness	80
Firewall Cable	282
Firewall Harness	278
Firewall Pad & Tool	95
Firewall Wire Harness	282
Gas Tank to Body	308
Gear Shift	400
Glove Box Arm	122
Grille Bar Wiring	248
Headlight Bucket Wire	69
Headlight Wire	281
License Light, Fuel Sender Wire	81
Parklight Wire	281
Pigtails, Taillight	67
Power Steering Hose	419
Power Steering Ram Cylinder	420
Radiator Core Support Wiring	384
Spark Plug Wire Rubber Separator	273
Speedometer Cable	280, 282
Starter Harness	280
Transmission Linkage	524
Valve Cover Breather Cap	298
Window Regulator	622
Ground	
Box	239
Splice System	239
Strap, Engine	239
Strap, Radio	239, 254
Guard(s)	
Accessory Gas Door	37
Bumper	52
Bumper Bullet	50
Guide(s)	
Convertible Top Adjustments	663
Glass Track Roller	636
Liftgate	648
Plate, Brake Shoe	466
U-Channel	627
Window Roller	636
Gutters, Cowl Side Drain	619
H	
H.I.D. Headlights	72
Halogen Headlights	73
Harness	249
Handbooks	670
Handle(s)	
Clip & Removal Tool	611
Convertible Top	178
Dipstick	521
Emergency Brake	123
Gasket, Deck	608
Inside Door	608-610
Outside Door	609
Reinforcement	564
Release Mechanism, Door	612
Spring	611
Tailgate with Button	55
to Latch Rods, Tailgate	651
Vent	608-609
Washer, Plastic	611
Window	608-610
Hangers & Brackets,	
Mufflers & Tailpipes	358
Hardline Notchhead Clamp Kits	475
Hardline Pressure Tube	416
Hardware	
Accessory Guard	52
Brake	469
Master Cylinder	465
Bumper Mounting	53
Convertible Windshield Frame	
Moulding	180
Generator &	415
Generator Mounting	241
Hood Hinge	289
Ignition Wire Support	262
License Plate	57
Power Steering	415-416
Rear Axle	431
Rear Quarter Pivot Assy	179
Shift Linkage Kit	524
Window Roller Guide	636
Harmonic Balancer & Related	500
Harmonic Dampers	500
Harness(es)	
City Light Headlight Wire	72
Door Sill Covers	143
Clips	280, 549
Dome Light Lens	80
Door Sill Covers	143, 565
Factory Fit	251
Fuel Injection	248, 348
Grommets, Firewall	282
Headlight	247, 249, 251
Headlight Relay	74
Pigtails & Grommets, Taillight	67
Tachometer	104
Thermostat	368
Third Brake Light	68
Transmission Controller	514
Wire	249-251
Auto Meter Universal	108
Headlight	74
Painless Performance	247-248, 348
Hats & Hat Pins	703
Head Plugs	367
Header(s)	350-352
Bolts	357-358
Bow, Convertible Front	175
Gaskets, Aluminum	358
Magnaflow Exhaust Kits	353
Manifold Blanket, Thermo-Tec	360
Headlight(s) & Related	71-73
Adjustment Screws & Springs	71
Bezels & Related	70
Buckets	69
Crystal Bulb	73
Crystal Halogen	74
Delta & H. I. D.	72
Grommets	280
Halo, Halogen & OE H4	72
Harnesses	247, 249, 251
Knob(s) & Shafts	93
LED Halo	74
Mounting Bracket	540
Patch Panels	540
Relay Harness	74
Retaining Rings	70
Sealed Beam	71
Seals	68
Shaft	274
Switches & Related	75, 274
Headliner Bows & Related	144
Nomad	173
TMI Molded	187
Heads, Cylinder	341
Heat	
Insulator Carb Bore Gaskets	339
Riser & Related	354
Tubes, Choke	321
Shield	302
Heater	
Assembly Fasteners	362
Block Off Plate	363
Blower Hole Covers	366
Blower Motors & Seals	366
Box Retainers	364
Cables & Clips	364
Control Bezel	362
Control Cable Retainer Clips	364
Control Face Plate Lenses	84, 98
Control Knobs & Levers	365
Control Valves	363
Core Mounting Plates	363
Cores	362
Defroster Seal	371
Hose Fittings	367, 504
Hoses & Hose Clamps	368
Housing to Inner Fender Retainer	364
Lens Backing Plate	363
Lever Pin and Spring Repair Kit	363
Motor Mounting Screws	366
Seals	365
Hedman Headers	352

Heidt's Dropped Spindles	458	Bracket, Power Brake Hose	465	Controls, MSD	269
Hex Plug.....	330, 367	Brake.....	468	Conversions, Pertronix	270
Hi-Tech Kickdown Kits.....	531	Clamps, Brake Vacuum.....	465	Keyless	253
Highway Series Modular Panel		Clamps, Heater	368	Lock Cylinder.....	263
Wiring Systems	250	Convertible Top & Related.....	176	Lock Sets, Door and	612
Hinge(s)		Fittings	300-301, 368, 504	Module, Pertronix.....	270
Bushing, Door.....	617	Fuel Transfer	308	Ring Nut Tool	90
Door	565, 617, 624	Gas Line	311	Switch Bezels & Related.....	90, 262-263
Glove Box.....	122-123	Heater & Related	367-368	Wires	262, 266, 272
Hardware Kit, Hood.....	289	Kits, Edelbrock	342	Linear Looms	263, 273
Hood & Related	284-286, 289	Nipples, Vacuum/Fuel.....	322	Indicator	
Pin, Door.....	617	Oil Filter	499	LED Boot	528
Screws, Door	617	Power Steering.....	415-417	Lenses, Dash & Transmission	83-99
Tailgate.....	594, 650	Rack and Pinion	411	Switch, Emergency Brake	471
to Door Bolts	617	Radiator.....	387	Wire Rods, Shift.....	523
to Pillar Screws.....	617	Heater & Related	367-368	Induction Systems, Realduction Air.....	279
Torsion Rods.....	168	Pro Flex	300	Insert(s)	
Trunk	169, 286	Radiator & Related.....	387	Bumper.....	50
Trunk Lid Assy, Convertible	179	Steering Box.....	409	Color.....	83, 98-99
Tailgate & Related.....	650	Vacuum.....	322	Dash Panel.....	107
Hingemounts, Cowl Side Extension.....	555	Treadle-Vac	465	Metal, Armrest.....	129
Hog Rings & Pliers.....	133	Vent.....	308	Radio.....	89
Hold Down(s)		Hot Rods by Dean Cooling Modules	383	Side Panel.....	43
Battery.....	235-236	Hotchkis Tubular Sway Bars.....	441	Inside Mirrors.....	124-125
Clamp, Distributor.....	267	Housing(s)		Installation Tool(s)	
Clamp, Valve Covers	297	Bolts, Bell	510	Crank Gear	500
Kit, Brake.....	469	Boots, Clutch Bell	526	Firewall Pad	95
Studs.....	265	Carb Choke.....	316	Harmonic Balancer.....	500
Valve Cover, Hex	297	Clock, Billet	89	Instrument Cluster	
Washers, Battery	237	Cover, Bell.....	526	Bezel Sets	100
Holders, Fuse.....	240	Dome Light & Related	80	Dakota Digital.....	116-120
Hole Covers, Access.....	619	Gasket, Rear Axle Housing	498	Gaskets.....	99
Hood(s)	536-539	Glove Box.....	122	Mouldings	101
Anti-Squeak Gasket Kits	551,606	License Light & Related.....	81	Refacing Kits.....	99
Bar and Extensions	32	Parklight	76	Screws	101
Birds	32-33	Taillight.....	62-63	Seals	99
Braces & Related	287-289	Thermostat	369	Socket Kit	101
Baffle.....	538	Thermostat & Related.....	369	Insulation Kit	
Bumpers	282,289	Wheel	597-599	Acoustishield.....	158
Emblems.....	18-19	Wheel & Seals	606	Dynamat	160-161
Hinges & Related	284-289	Hub Adapters, Steering Wheel	392-393	Thermo-Tec	157, 302
Latch & Related	290-291	Billet Specialities.....	395	Trunk Lid	167
Prop Rods, Self Locking.....	168, 289	Hub Cap	478	Insulator(s)	
Reinforcement Brace.....	288	Decals & Retainer Clips	479	Carburetor & Gasket	317
Rockets.....	34	Hub Kits, Steering Wheel	393, 397	Horn Post	291
Side Bumpers.....	289	Hula Girl Doll	704	Rubber, Trunk Torsion Spring ...	168, 180
Springs.....	288	Hydro-Boost Power Brake		Wire, Temperature Sending Unit.....	369
Stops & Stop Bolts.....	288	Conversion Kits.....	460	Intake	
Vees	34			Manifold	334-335, 368
Washers	289			Bolts	323
Hook(s)				Fittings.....	322
Coat	124			Gasket Kits	323, 337
Sunvisor, Convertible.....	180			Heater Hose Fittings	368
Horn(s)				Studs	322
Adapter Kits.....	397			Thermostat Housing Studs	322
Buttons.....	392,395			Washer	323
Cap.. ..	398			Interface, Fuel Gauge.....	115
Covers.....	291			Interface, Speedometer	119
Emblems.....	97, 398			Interior(s).....	184
Kits.. ..	97			Door Panel Trim Kits	620
Post Insulators.....	291			Joiner & Garnish Clips.....	620
Relays.....	275, 291			Mouldings	144
Rings & Related	96, 398-399			Pillar Weatherstrip	
Wire Grommets	281			Channel Mouldings.....	631
Wire Lead.....	399			Swatches	188,189
Wire to Inner Fender Clip.....	291			Trim Screws & Washers.....	147
Hose					
Adapters	386				
Air Inlet	371				

I

Ididit	
Keyless Ignition	253
Shift Knobs & Dress-Up Kits.....	407
Steering Columns.....	404-407
Idle Assembly & Related	319
Idler Arm(s).....	420
Bearing Kit & Related.....	423
Washer.....	422
Idler Levers, Emergency Brake	473
Ignition	
Retainer Nut	90
Support Brackets and Hardware....	262
Support Shields	262
Ballast Resistors	263
Box.....	269
Second Strike	272
Coils.....	264, 270
Bracket & Clamp Screw.....	264

Interior	
Upholstered	
1955	188-200
1956	201-212
1957	213-226
Windlace Garnish	148

J	
Jack Bolt for Continental Kit	58
Jack Handle & Lug Wrench	167
Jamb	
Brace & Patch Panels, Door	565
Dog Leg Repair Panels, Door	564
Patch Panel	588
Reinforcements	617
Door	565
Jets, Carburetor	315
Joiner Clips, Interior Door Panel	620
Joint(s)	
Ball	423
Caps	428
Flaming River Rag	408
Rag	410
Universal	513
Junction Blocks, Brake	469

K	
Kenwood Audio	255
Key	
Blanks	614
Fob, Danchuk	660, 708
Keyless Door Lock Conversion	621
Keyless Entry Base Systems	621
Keyless Glove Box Lock Assembly	122
Keyless Ignition System	253
Kick Panel(s)	164, 183
Retainer	578
Speakers	256
TMI	186
Vent Door Seals	371
Kickdown & Related	531-532
Knob(s)	88
Convertible Top Switch & Shaft	179
Dash	88, 91
Door Lock	127, 616-617
Gear Shift	399
Headlight	93
Heater Control	365
Heater Control Lever	365
Radio	92, 254
Radio Bezel	89
Seat Adjustment	134
Shift, Ididit	407
Shift, Lokar	529
Turn Signal Plastic	399
Vent Pull	89
Windshield Wiper	92, 633

L	
Latch	
Assemblies, Door	614
Assembly, Vent Window	641
Convertible Top, & Screws	178
Glass Slider	647
Hood	290
Hood Spring Set	290

Mount Brackets	583
Plate	
Bolts	169
Glove Box	122
Screws, Trunk	169
Rods, Tailgate Handle to	651
Seat	174
Covers	174
Recess Trim	172
Tailgate	651
to Handle Pull Rods, Door	615
to Tumber Rods & Clips, Door	615
Trunk Assembly	169
Lead(s)	
Horn Cover Assembly	392
Horn Wire	399
Speedometer Sensor	522
Leaf Spring(s) & Related	431, 433-434
Lecarra	
Horn Buttons	392
Steering Wheels & Related	393
LED	
Back-UP Light	79
Boot Indicator	528
Brake Light Attention Module	68
Conversions, Taillight Lens	67
Dome Light Assembly	80
Fan Controller	374
Flasher	66
Halogen Headlights	74
Headlight	72
Lens Assemblies	66
License Plate Frames	57
Light	
Bulbs	82
Dimmer	107
Dimming Kit	120
Outside, Rear View Mirror	46
Parklight & Related	77
Taillight Reflector	62
Lens(es)	
Back-UP Light & Related	78
Backing Plate for Deluxe Heater	363
Dash	84, 98
Dome & Bezel	80
Flaming River Gear Shift	408
Gasket Sets	65, 79
Gear Shift	408
Heater Control Face Plate	84, 98
Heater Pin	363
Indicator, Shift & Transmission	83, 99
Indicator, Shift, Column Mounted	83, 99
LED	
Assemblies	66
Conversions	67
License Light & Related	81
Parklight	77
Radio	84, 98
Screws	76
Spring, Gear Shift	401
Taillight	64, 65
Lever(s)	
Covers, Flipper	618
Emergency Brake Idler	473
Emergency Brake Shoe	472
Gear Shift Spring	401
Heater Control	365
Heater Pin	363
Shift Column Linkage Bushing	407

Transmission Kickdown Assembly	532
License	
Bezels	81
Gaskets	81
Wire Grommet	81
Light, Housing Assemblies & Related	81
Plate(s)	705
Bolts & Related	56-57
Lid	
Covers, Under Trunk	158
Trunk & Related 166, 168-169, 582-583	
Alignment Kit	167
Hinge Assembly, Convertible	583
Insulation Kit	167
Nomad Cargo Trim, Spare Tire	170
Trunk, Hinge Assemblies	179
Lifeline Memory Retention Systems	238
Liftgate & Related	644, 648-649, 652
Light(s)	
Back Plate	92
Covers	82
3rd Brake & Related	68
Backup, Lenses & Related	78, 79
Bulbs	82
Dimming Kit, LED	107, 120
Dome	80
Housings & Related	80
Switch Cover	80
Emergency Brake Warning Kit	470
License, Housings & Related	81
License Plate Frames	56-57
Stop Switch	470
Switch & Related	80, 123, 274-276
Trunk & Underhood	79, 168
Viewers, Traffic	124
Lighters, Cigarette	93
Line(s)	
Brake & Related	468, 474-475
Clips	313
Roadster Shop Chassis	446
Clips	311, 313
Clamps	313
Distributor Vacuum	265
Fuel Injection Vent	348
Fuel, Edlebrock	342
Gas & Related	311-312
Oil Filter	498
Nothead Clamp Shop Builder Kits	693
Proportioning Valve	459
Transmission Oil Cooler & Related	517
Linear	
Looms, Wire	263, 273
Liner Kits, Trunk & Trunk Lid	166
Link	
Anti-Sway Bar Kit	436
End Bushings	437
Linkage	
Adjustable Steering Column Shift	403
Assemblies	325
Brackets, Carburetor Mounted	315
Carburetor	315
Emergency Brake Return Springs	473
Manual Steering Kit	421
Retaining Clip	524
Rods & Clips	325, 520
Shift	
Adjustment Swivel Nut	409
Cable & Related	523-524

Column Lever Bushing 407
 Sleeve, Accelerator..... 324
 Transmission Grommets..... 524
 Literature..... 660-664, 666-671
 Lizardskin Insulation..... 159
 Locating Clips,
 Slider Glass Channel 647
 Locator Kit, Gas Tank..... 307
 Lock
 Bolt Spring Retainer..... 58
 Bolt, Exhaust Manifold 356
 Cylinder, Ignition..... 263
 Cylinder Pawl Clip..... 613
 Firewall Plate..... 279
 Glove Box..... 122
 Housing 122
 Knobs, Door 127, 616-617
 Pawl Retainer Clip..... 613
 Plates, Door Striker 616
 Power Keyless Door Conversion..... 621
 Power Window 624
 Retainer
 Door & Trunk..... 613
 Glove Box 122
 Return Spring, Trunk..... 167
 Ribbed Cap 613
 Rod, Door, w/ Clips..... 615
 Sets
 Complete..... 612
 Door and Ignition..... 612
 Trunk and Glove Box..... 613
 Shaft, Trunk 613
 Steering Box Washer..... 411
 Support Assembly Pad Kit..... 58
 Turn Signal Housing Plate..... 399
 Vent Window Frame..... 642
 Wheel 483
 Lock-Up
 Kits, Torque Converter 515
 Switch, Torque Connector 515
 Lockwasher, Wheel Cylinder French..... 467
 Lokar
 Emergency Brake & Related 471
 Engine Dipsticks 493-494
 Handles & Related 610-611
 Door Pulls, Oval Arm Rest..... 610
 Kickdown 531
 Pedals & Pedal Pads 154-156
 Port Brackets..... 320
 Rods..... 168
 Shifters & Related..... 528-530
 Sliding Bezels..... 529
 Steering Column Shift Linkage Kit... 403
 Throttle Cables & Related 318, 320, 530
 Transmission Dipsticks 520-521
 Transmission Shift Arm..... 403
 Looms
 Ignition Wire..... 266, 273
 Spark Plug Wire 263, 266
 Louvers, Fender..... 47
 Lowering Blocks, Leaf Spring, Rear 433
 Lubricants 683, 685
 Lug, Nut & Stud 478, 483
 Lug, Wrench..... 167

M
 Manifold
 Exhaust & Related..... 354, 356, 359
 Header Blanket, Thermo-Tec 360
 Intake 334
 Bolts 323
 Edelbrock & Related 334-338
 Fittings..... 322, 368
 Gaskets 323
 Studs 322
 Washers & Fittings..... 323
 Manual(s) 660-664
 Accessory Installation..... 660
 Air Conditioning Shop..... 662
 Antenna 260
 Assembly 660
 Chevrolet..... 661
 Delco Remy Equipment 662
 How To Build
 Hi-Performance Trans Book 667
 Owner's..... 661
 Pattern of Profit 662
 Power, Inline Six-Cylinder 667
 Rochester Fuel Injection 663
 Shop..... 661-663
 Wilwood Cylinders 456
 Mask(s), Speaker & Speedometer 89
 Master Cylinder(s) & Related 462-465
 to Junction Block Brake Lines 474
 Mat(s)
 Floor..... 149-151, 165
 Insulation..... 157
 Parking 689
 Trunk 166
 Mechanism(s)
 Door Handle 612
 Door, Screws..... 612, 619
 Interior Door Release..... 612
 Turn Signal..... 399
 Metal Channels, Glass..... 635
 Metering Rods and Jet, Carburetor 315
 Milodon Oil Parts..... 494-498, 520
 Mini Tub Kit..... 599
 Mirror(s)
 Interior 124
 Rear View 46
 Support, Inside..... 180
 Vanity Visor 125
 Module
 Auto Meter Speedometer 108
 Be Cool A/C Condenser 388
 Brake Light 68
 Cooling, Hot Rods By Dean 383
 Distributor 270
 Fuel Injection 305
 GPS Speedometer Interface 253
 Ignition 270
 Radiator Conversion 379-380
 Replacement Fuel Injection 346
 Moldable Mouldings, Exterior..... 37
 Monroe, Shock Absorbers 435
 Morrison Chassis 444-445
 Motor(s)
 Amsoil Oil With Zinc..... 686
 Convertible Top & Related 176, 280, 283
 Heater Blower..... 366
 Lift Plate..... 492
 Mount(s) & Related 490-491

Brackets 490
 Billet Specialties Plates 492
 Bolts by ARP..... 490
 Conversion Kit..... 492
 Rubber Cushions 491
 Side Conversion Kit 492
 to Engine Brackets 491
 Polyurethane Side Mounts 492
 Wiper & Related..... 632-633
 Moulding(s)
 Beltline..... 45
 Center Post Beltline 45
 Clip(s)..... 60, 620, 625, 630
 Dash 94
 Pins 44
 Rocker Panel 35
 Screws 45
 Side Window..... 59, 625
 Universal 59
 Vertical..... 44
 Connectors, Windshield 59, 625, 630
 Corner, Rear Window 626
 Door Belt..... 45, 620
 Fin, Vertical..... 44
 Front Seat Cushion..... 134
 Garnish 145-146, 148
 Glass 628
 Grille 27
 Hardware, Windshield Frame..... 180
 Instrument Cluster 101
 Interior Pillar Weatherstrip Channel... 631
 Moldable, Exterior..... 37
 Moldable Interior 144
 Post, Center 45
 Rear Deck, Trim Kit..... 41
 Rear Window 628
 Rocker Panel 35
 Screws
 Door Belt..... 619
 Door Window..... 625
 Inner Quarter Window Curved 638
 Nomad Side Window..... 648
 Quarter Belt 45, 180
 Side 36, 38-41
 Top of Fin & Related..... 44
 Vent Glass, Vertical 641
 Vertical Slider Glass 646
 Window, Upper Rear..... 629
 Windshield & Related 629-630
 Mount(s)
 Battery Boxes 234
 Bolts 490
 Brace Assembly..... 176
 Conversion Kit..... 492
 Bearing Shock Kits..... 427, 437
 Body & Related..... 578, 604-605
 Cab 492
 Compressor Brackets, A/C 504
 Dimmer Switch Plate..... 578
 Emergency Hand Brakes & Related... 471
 Fender Brackets..... 556
 Floor Shifters..... 528
 Gas Pedals 153, 155
 Gas Tank 307
 Generator Bushing Sleeve 241
 Hardware Kits..... 434
 Latch, Brackets..... 583
 Leaf Spring Relocation Rear Shock... 433

Motor, & Related.....490-492
 Rubber Cushions.....491
 Power Steering Pump Brackets.....412
 Proportioning Valves463
 Rear Seat Floor.....563
 Side Motor491
 Conversion Kit.....491
 Transmission Conversion Kits.....511
 Shock Rubber.....434
 Steering Column Firewall Plate403
 Steering Column Floor402
 Studs, Leaf Spring Plates.....433
 Transmission & Related510
 Trunk, Battery Cables237
 Universal Parking Brake Cable Kits...470
 Mounting
 Bracket
 Generator, & Hardware241
 Headlight540
 Bushings, Anti-Sway Bar.....436
 Cups, Auto Meter Gauges.....109
 Hardware
 Bumper53
 Heater Motor.....366
 Power Steering/Generator415
 Kit, Generator.....241
 Plates, Heater Core363
 Plates, Tailgate Hinge.....650
 Screws, Wiper Motor.....633
 Seat Belt Kit.....131, 134
 Shock Studs.....434
 Steering Column Upper400
 Strap
 Bolts, Gas Tank306
 Gas Tank & Related307
 Taillight.....67
 Taillight.....67
 V8 Starter242
 MSD
 Atomic EFI347
 High HP Fuel Pump Kit347
 Master Throttle Kit347
 Throttle Body Kit.....347
 Atomic Transmission Controller.....514
 Coil Cover Kits.....348
 Ignition Products266-269
 Transmission Controller & Harness....514
 Muffler(s)
 Hanger & Brackets358-359
 Pipe Hanger Rebound Clip.....359
 Pipes Stainless.....353

N

Nails, Door Panel & Clips146, 619
 Neutral Safety Switches276
 Nipples, Vacuum/Fuel Hose & Fittings..322
 Noise Reduction Products160
 Nomad170-174
 Bumpers Sliding Window645
 Cargo Area Access Cover.....648
 Cargo Area Light Switch and Bezel80
 Dome Lens.....80
 Door Glass Upper Window Stop Kit ...637
 Doors562
 Liftgate Weatherstrip652
 Paint Divider Trim646
 Seals645
 Stainless Trim.....171-172, 174

Tail Panel Brace & Wagon594
 Tailgate.....693
 Cable Retractor653
 Clips55
 Script.....22
 Striker Cover652
 Vees54
 Window Clips.....647
 Window Seals & Related643
 Wagon.....147, 646-654
 Nose Cones, Water Pump502-503
 Noses, Water Pumo Pulley.....503
 Nothead.....468
 Hardline Clamp Kits.....475, 693
 Line Clamp Shop Builder Kits693
 Softline Clamp Kits475, 693
 Number Decals, Odometer.....102
 Number Emblems, Engine Displace.....23
 Nut(s)
 A-Arm Retainer426
 Air Cleaner328
 Antenna260
 Cowl Brace Cover with Cap.....283
 Exhaust Manifold356, 359
 Headlight Switch Retaining.....75, 274
 Headlight Switch Tool.....631
 Ignition Switch90, 263
 Leaf Spring434
 Pitman Arm to Steering Box.....410
 Shift Linkage Adjustment.....523
 Swivel409
 Speed, Taillight Housing.....67
 Steering Box.....411
 Steering Wheel to Shaft400
 Switch Tool.....275
 Taillight Curved J62
 Tool, Wiper Eschutcheon.....631
 Tube301
 Under Steering Wheel Washer400
 Valve Cover.....296
 Washers432
 Wheel Lug.....478, 483
 Winged Speed
 Fasteners & Tool.....28, 59
 Wiper Switch Retainer633
 Nylon, Brake Pedal Shaft Bushing.....467

O

O-Ring(s)
 Aeromotive330
 Boss Port Plug.....333
 Convertible Sunvisor.....180
 Gas Tank Filler Tube.....308
 Thermostat Housing369
 Octane Boost.....687
 Odometer Number Decals.....102
 Oil.....686
 Adapter.....499
 Cap & Breather Caps298
 Coolers, Transmission & Related517
 Dipstick Tube520
 Filter499
 Bypass Valve Kit.....499
 Elements499
 Hoses.....499
 Lines.....498
 Spin On Conversin Kit.....499
 Gear, Limited Slip.....681

Generation HD Limited Slip Gear.....681
 Pan(s) & Related.....496-498
 Transmission.....516
 Pressure
 Gauges, Sender & Tubing115
 Sender121
 Sending Unit499
 Pump.....680
 Milodon.....497
 Primer.....497
 Studs497
 Reservoir Seal.....328
 Seals422
 Tubes.....494, 499
 Wheel Bearing And Seals.....476
 Optima Battery & Related.....234-235
 Outside Rear View Mirrors.....46
 Overflow Tank, Coolant386

P

Package Shelves.....164, 182
 Pads
 Armrests128
 Battery Hold Down236
 Brake & Clutch Pedal154-155
 Continental Lock Support Kit58
 Convertible Pinch Rail180
 Dash.....94
 Dimmer Switch Pedal154, 157
 Disc Brake.....466
 Firewall & Related.....95
 Pedal152
 Power Brake Pedal154
 Rubber, Turn Signal Bushing.....401
 Painless Performance
 Wire Harnesses247-248
 Transmission Controller.....514
 Paint
 Dividers37-38
 Gaskets.....608
 Nomad.....646
 Pan(s)
 Floor.....570, 576-577
 Oil & Related.....516-517, 496-498
 Plug, Floor604
 Retainers, Front Splash To Fender ...545
 Seal, Splash541, 606
 Panel(s)
 A Pillar w/ Cowl.....558-559
 Aluminum Side Insert.....43
 B-Pillar Full.....559
 Braces, Trunk579
 Brackets.....601
 Cardboard164, 182-183
 Cowl554-555
 Custom Trunk Kit.....163, 183
 Dash105, 554
 Door
 Attaching Strip.....147, 620
 Cardboard.....162
 Clip.....164
 Clip and Nail Set.....146, 619
 Rear, Jamb Dog Leg Repair564
 Metal Bands146
 Pillar Lower Patch564
 Reinforcement589
 Retainer578
 Retainers, Rear Seat.....564

Trim Joiner Clips	147, 620	Pad		Lens Backing.....	363
Trim Kit.....	145	Brake	154	License	705
Filler.....	541	Clutch	154-155	Bracket	57
Firewall, Replacement	278, 553	Dimmer Switch	157	Light Housing	81
Fuse	240	Throttle	156	Frame	56-57
Gauge	109	Perches, Rear Axle Leaf Spring	431	to Trunk Lid Cushions	57
Inner Trunk Lid.....	583	Perfect Launch Rear End Cover.....	432	Lid.....	169
Inserts, Dash	107	Pertronix Performance Products ...	270-273	Light Assembly.....	81
Kick	164, 182-183, 256	Petcock, Radiator	387	Lower Tailgate Hinge Mounting.....	650
Modular Wiring, Highway Series	250	Pick-Ups, Oil.....	497	Motor Lift.....	492
Patch.....	589	Pigtail(s)		Motor Mount, Billet Specialties	492
Door Jamb And Window Skin	565	Power Window Button Switches.....	624	Mounting, Heater Core.....	363
Fender	550	Taillight Harness & Grommets	67	Screws	57
Fender Headlight.....	540	Pillar		Seat Stop	133
Gasser Body Wheel Well Opening ..	588	Convertible Windshield Center.....	601	Sill & Related	142-143
Headlight	540	Front Door Hinge Screws.....	617	Speaker	92
Quarter.....	580	Screws, Windshield	631	Steering Column Firewall Mount.....	403
Tailpan To Quarter	594	Seals, Windshield	631	Striker, Convertible Top.....	178
Package Shelf With Flange.....	592	Spacer Caps, Window	627	Switch Back, Light Wiper.....	92
Plugs, Rocker	604	Weatherstrip Channel Mouldings.....	631	Throttle.....	319-320
Quarter	584-589	Pin(s)		Transmission Inspection Cover.....	515
Radiator Core Support Filler	544	Brake Wheel Cylinder	467	Trunk Floor	579
Realduction Air Duct	279	Door Hinge.....	617	Trunk Latch	169
Realduction Duct Block-Off.....	553	Header Guide	177	Turn Signal Housing Lock	399
Rear Window to Trunk.....	591	Gear Shift Arm.....	400	Window Adjusting, Quarter.....	627
Rocker & Related	35, 556-557	Heater Lever	363	Window Regulator Gear.....	622
Roof	590	Top of Moulding.....	44	Pliers, Hog Ring	133
Screws, Inner Door Access	619	Trunk	169	Plug(s)	
Seat, Cardboard	164	Pinch Rail Pads, Convertible.....	180	Access, Trunk Area, Inner	167
Supports	601	Pipe		Allen Socket.....	300
Tail Pan to Quarter Filler ..	581, 589, 594	Hose & Related.....	308	Alternator.....	246
Transmission Center	576	Socket Plugs	300	Body Mount Access.....	578, 604
Trunk		Support Bracket, Gas Tank.....	308	Door 619	
Cardboard.....	183	Piston & Armrest Cover Assembly		Drain, Rear End	431
Splash.....	581	Convertible.....	601	Fender Antenna	283
Parking		Pitman Arm & Related	410-411	Floor Pan	577, 604
Brake & Related.....	470	Pivot		Front Fender Antenna.....	280
Mats	689	Assemblies		Hex	330, 367
Parklight		Rear Quarter	179	Oil Pan Drain.....	498, 513
Housing Assemblies	76	Quarter Window,	638	Overdrive Wire Harness Switch	530
Housing Seals.....	68	Bracket, Convertible Top.....	176	Port, O-Ring Boss.....	333
LED Conversion	77	Bracket Rivets,Vent Window Frame ..	642	Rear Body Mount Access	604
Lenses & Related	77	Rivets, Windshield Wiper	632	Rocker Panel	556, 604
Screws	76	Seat Bolt.....	174	Rubber Brake Hole Adjustment	467
Wire Grommets	281	Studs, Clutch & Related	525-526	Socket Head.....	367
Passing Gear Linkage Rods.....	325, 520	Plate		Spare Tire Well	167, 283, 604
Patch Panels.....	565, 588-589	Adjusting, Quarter Window.....	638	Spark & Related	
B-Pillar Lower.....	564	Back-up Light Conversion	78262-263, 265-266, 268, 273	
Fender, Lower Front & Rear.....	550	Block Off.....	313	Trunk Area Inner Access	604
Door Jamb.....	588	Bolts.....	57, 169	Twelve-Point	367
Door Pillar.....	564	Brake Shoe Guide	466	Wire Harness Disconnect	238
Gasser Body Wheel Well Opening.....	588	Carb Adapter, Edlebrock	339	Pocket(s)	
Headlight	540	Convertible Frame Rail Skid.....	601	Rear Spring Relocation Kit.....	430
Inner Trunk.....	580	Convertible Top.....	178	Rear Seat Floor	563
Quarter	580	Dimmer Switch Mount.....	578	Polish	
Tailpan to Quarter Panel	581, 594	Door		Danchuk Vintage.....	674-675
Patriot Headers	351	Hinge.....	617	Dash.....	88
Pawl		Post Striker & Locks	616	Kits, Car Care	677
Lock Clips	613	Striker Lock	616	Metal, Plastic & Fiberglass.....	678
Turn Signal Kit.....	399	Engine Starter	522	Polyplus Steering & Front End	424
PCV Valve		Face, Continental Kit.....	58	Post	
Billet Specialties.....	299	Firewall.....	279	Board Cardboard	163
Conversion Kit	297	Fuel Pump Block-Off.....	313	Center Mouldings.....	45
Pedal(s)		Globe Box Latch	122	Door Striker Screws.....	616
Accelerator	152, 157	Heater Control	98, 363	Striker Plates, Door	616
Accelerator Rod Bushings	325	Hood Latch	290	Posters	707
Brake & Related.....	152-156, 464, 467	Intake Manifold Gaskets	323		
Clutch & Related.....	524-527	Leaf Spring Lower Shock Mount			
Gas	153-155	Shock Mount Studs	433		

Power Brake			
Boosters & Related.....	460-461		
Hose Bracket.....	465		
Vacuum Hose Clamps.....	465		
Power Seat & Related	134-135		
Power Steering			
Amsoil Synthetic Fluid.....	687		
Box	410, 419		
Centerlink	420-421		
Control Valve With Hoses	419		
Filter Kits.....	419		
Pitman Arm & Related.....	410-411		
Rack & Pinion & Related	411		
Hardware Kit	415-416		
Heat Shields.....	355		
Hose & Related.....	300-301, 415, 417, 419		
Idler Arm.....	420		
Pumps & Related.....	416		
Brackets.....	412-415		
Reservoirs.....	418		
Ram Cylinder & Related.....	420		
Rebuild Kits	419		
Tie Rod Adjustment Sleeve.....	424		
Power Window & Related	623-624		
Powerglide Shift Detents	523		
Powermaster			
Alternator & Related.....	242, 245		
Starters.....	243		
Pressure			
Adapters	301		
Check Valves, Residual.....	460		
Fittings	416		
Fuel Gauges	107, 332		
Gauges Classic Instruments	114		
Hardline Tube	416		
Oil Senders, Dakota Digital	121		
Regulator	344		
Sending Unit, Oil.....	121, 499		
Wilwood Residual Valves.....	456		
Primer, Oil Pump, Milodon	497		
Procar Bucket Seats & Related	140-141		
Professional Products			
Harmonic Dampers.....	500		
Prima-Star Shocks	436		
Proportioning Valves & Related	457, 459, 463		
Pull(s)			
Door.....	610		
Knobs.....	89		
Rods, Door Latch to Handle	615		
Straps & Tips.....	182		
Puller, Harmonic Balancer.....	500		
Pulley(s)			
Alternator.....	246		
Bolts.....	501		
Crank.....	501		
Crankshaft.....	501		
Noses & Shims, Water Pump.....	502, 503		
Power Steering Pump	414		
Saginaw Power Steering Pump	415		
Systems	508, 509		
Water Pump	502, 503		
Pump(s)			
Accelerator.....	337		
Fuel & Related			
249, 301, 313, 329-330, 343, 347			
Fuel Injection	305, 346		
Oil			
Drive Shafts.....	498		
Milodon & Related.....	497		
Sta-Lube	680		
Stud Kit	497		
Power Steering & Related	412-415, 417		
Pulleys.....	502		
Power Steering & Related.....	416		
Rebuild Kit.....	503		
Reservoirs, Power Steering.....	418		
Water.....	503-504		
Push Button			
AM/FM Radio.....	254		
E-Stopp Emergency Brake Kit	472		
Pushrods			
Edlebrock.....	340		
Fuel Pump by ARP.....	313		
Wilwood Universal Master Cylinder.....	456		
Pyper Exhaust.....	353, 357		
Q			
QA-1 Shocks	436		
Quarter			
Fuel Door Box.....	314		
Beltline Mouldings.....	45		
Connector Moulding Clip.....	60		
Garnish Mouldings, Inner.....	145		
Garnish Trim, Inner	181		
Glass Brackets, Rear	647		
Glass Seals.....	643		
Glass Track L Stop	635		
Nomad Rear Glass Seals.....	647		
Panel(s)	584-588		
Lower Rear Patch	589		
Outer Wheel Well Supports.....	601		
Patch Panels.....	580		
Rear Bumper Reinforcement.....	589		
Support Braces	589		
Tailpan	581, 589, 594		
Upper Support Panel Brackets, Inner, Convertible	601		
Rear Full Sections.....	585		
Screws.....	45		
Window Frames & Related	638-639		
Window Moulding Clips, Rear	625		
Window Tracks.....	639		
Quartz Clocks	102		
R			
Race Ramps.....	688		
Rack and Pinion & Related.....	411		
Radial, Whitewall Tires.....	484		
Radiator(s).....	378, 380-382		
Be Cool A/C Condenser Module	388		
Bug Screen	384		
Caps.....	377, 388		
Center Filler Panels.....	544		
Clamps	386		
Cold Case.....	376		
Conversion Brackets.....	384		
Conversion Modules	379-380		
Core Support	542-543		
Covers.....	385		
Hoses	387		
Petcock.....	387		
Side Filler Panels.....	542, 544		
Splash Shields.....	545		
Strap Assembly.....	542		
Support Related.....	384		
Splash Pan Bracket	541		
Zinc Anode.....	386		
Radio			
Bezels Knobs.....	89		
Custom Autosound	258		
Ground Straps	239, 254		
Insert, 2-Gauge.....	89		
Knobs.....	88, 92, 254		
Tone Control.....	254		
Lenses	84, 98		
Push Buttons.....	92, 254		
Speakers.....	254-257		
Grille Clips.....	89		
Tube & Related	254		
Wonderbar.....	255		
Rag Joint	409-410		
Steering Column	408		
Rail, Drip	591		
Rail, Skid Plates, Convertible Frame	601		
Rail, Roof & Stops	591, 645		
Raingear Windshield	634		
Wiper & Washer Kits.....	634		
Rally Wheels & Center Caps.....	477-478		
Ram Cylinder, Power Steering	420		
Ramps	688-689		
Realduction			
Air Induction Systems	279		
Firewall Duct Black-Off Panels	553		
Fresh Air Block-Off Plates.....	279		
Rear			
Antenna	260		
Accessory Fender-to-Fender			
Skirt Seals.....	606		
Armrest.....	128, 563		
Ashtrays	124		
Axle & Related.....	431, 498		
Bracket & Related	563, 556		
Bumpers	51		
Decals, Bumper End.....	54		
Differential Pinion Seal.....	431		
Door Jamb.....	564-565		
Door Lock Rod Assemblies.....	615		
End			
Brackets, Bumper.....	53		
Conversion Kit & Related.....	430		
Cover & Related	432		
Disc Brake & Related.....	452, 468		
Drain Plug	431		
Ford 9 Inch Posi.....	429		
Gasket.....	432		
Snubber Bracket	429, 583		
Floor & Related.....	576, 579-580		
Leaf Springs Lowering Blocks.....	433		
Garnish, Interior Windlace.....	148		
Hardware, Bumper	52		
Housings.....	597-598		
Main Seals	499		
Moulding Kit	41		
Moulding Screws.....	45		
Package Shelves	164		
Plugs	431, 578, 604		
Quarter Panel	585, 589		
Quarter Pivot Assy Hardware.....	179		
Seat & Related	563-564, 576		
Splash Panel	581		
Spring Locating Pocket Kit.....	430		
Spring Shackles.....	431		
Suspension Kit, 4-Link	430		
Sway Bars	439		

Trunk	579	Kit(s)		Retractable Seat Belts	132
Wheel & Related	598-599, 606	A-Pillar Upper Side Cowl	558	Retractor, Tailgate Cable.....	653
Window & Related.....	59, 592, 618, 630	Heater Lever Pin & Spring.....	363	Return Spring	
Rear View Mirror(s)	46	Rear Door Jam Dog Leg Panels.....	564	Brake Shoe.....	466
Interior	125	Replacement		Carburetor	317
Rebuild Kits		Body Mount Frame Brackets	605	Clutch Pedal	526
Carburetor	315, 339	Brake Rotors.....	466	Transmission Indicator.....	83, 99
Front End & Steering, Polyplus.....	424	Electric Wiper Motors	632	Throttle.....	318, 320
Generator	241	Fuel & Related.313, 330-331, 342, 346		Trunk Lock	167
Liftgate Arm	649	Milodon Oil Pans.....	496	Ridetech, Shocks.....	437
Pump, Convertible Top.....	177	Rear Disc Brake Hoses	468	Rims, American Racing Torq-Thrust.....	479
Starter	242	Smooth Firewall Panels	553	Ring Brothers	
Steering Box.....	409	Urethane Ball Joint Boot.....	423	Hood Hinges & Stops	285
Suspension.....	425	Water Pumps	504	Ring(s)	
Water Pump	503	Reservoir		Auto Meter Gauge	109
Red Stripe Locking Gas Cap	309	Caps, Power Steering Pump	416	Bel Air Horn Center Caps	399
Reel		Power Steering Pump	418	Center Caps.....	96
Seat Belt.....	131	Seal	328	Dash Bezel Set	90
Tailgate Brackets.....	653	Residual Pressure Check Valves	460	Firewall.....	281
Reflector		Resistor(s)		Headlight Retaining	70
Glass	75	Ballast	263, 268, 283	Hog & Pliers	133
Taillight LED Kit	62	Heater Blower Motor.....	366	Horn & Related.....	96, 398
Under Taillight.....	62	Restoration Kits		Master Disconnect	239
Refractometer, Evans Coolant	385	Generator	241	Nut Tool.....	90
Regulator.....	332-333	Retainer(s)		Power Steering Pump Cam.....	416
Assemblies, Window & Related.....	622	A-Arm Dust Shield	282, 427	Shifter Boot, Lokar	529
Engine Fuel Filter	344	Axle, Rear	431	Spare Tire Lid Lift	171
Fuel Pressure, Edlebrock	344	Back-Up Light Cover	78	Stainless Rally Wheel Trim	478
Screws.....	275	Body Mount.....	604	Tire, Continental Kit	58
Voltage.....	241	Clips.....	364	Riser(s)	
Window & Related.....	624	Curved Quarter Glass	638	Choke Heat Tubes	321
Reinforcement		Firewall Seal	278, 403	Heat, Exhaust.....	354-355
A-Pillar	558	Tailgate Window	649	Rivet(s)	
Body Mount.....	578	Wire Wheel Hubcap	480	Bolt, Grille	30
Convertible Drain Channel.....	601	Clock, Bracket	102	Cowl Tag	283
Door Handle	564	Continental Kit		Flipper.....	618
Door Jamb.....	565, 617	Lock Bolt Spring	58	Quarter Window	638
Fender	548-549	Rear Back Pad Cup.....	58	Vent Window Frame Bracket.....	642
Hood Brace	288	Convertible Top Boot	178	Window Regulator Rollers	624
Quarter Panel and Rear Bumper	589	Door Lock.....	613, 620	Windshield Wiper Pivot	632
Rear Floor	576	Firewall Seal.....	95	Roadster Shop Chassis.....	446
Trunk Floor Center.....	580	Fresh Air Duct Cable	370	Rockers With Fender Brackets.....	556
Upper B-Pillar	559	Front Seat Bracket	133	Rocker Panel(s) & Related	556-557
Relay Kit(s)		Glove Box Lock	122	Braces	557
Door	621	Hardware, Rear Axle Bearing.....	431	Mouldings	35
Electric Fan.....	374	Headliner	144	Plugs	604
Horn	275, 291	Heater & Related	364	Rocket, Hood & Related	34
Fuel Pump	249	Kick Panel.....	578	Rod(s)	
Release		Nut		Bushings, Accelerator Pedal.....	325
Carburetor Rod	316	A-Arm Upper And Lower.....	426	Carburetor & Related.....	315-317
Clutch Bearing.....	525	Ignition Switch.....	90	Clips, Linkage.....	325
Mechanisms, Interior Door	612	Wiper Switch.....	633	Clips, Tailgate.....	651
Relining Kit		Power Window Switch & Locks	624	Clutch.....	525
Flipper.....	618	Quarter Window Weatherstrip	638	Door	615
Window.....	627	Rubber, Nomad & Wagon Liftgate.....	649	Emergency Brake Adjustment.....	472
Relocation		Seat Door Panel	564	Hood	
Bracket	415	Splash Pan to Fender	545	and Trunk Prop.....	168, 289
Coil Kit, Ignition	264	Trunk Lock	613	Brace	288
Milodon Oil Filter Kit.....	496	Wiper Motor Cable.....	634	Washers.....	289
Rear Shock Mount.....	433	Retaining		Lower Tailgate Handle To Latch	651
Rear Spring Pocket Kit	430	Bolt	167	Passing Gear Linkage	325, 520
Remote		Classic Update.....	75	Rear Door Lock Assemblies	615
Disconnect Switch	238	Clip(s)		Shift Indicator Wire	523
Power Steering Reservoirs	418	Back-Up Lens	78	Steering Connecting Dust Covers	421
Reservoirs For Hydroboost.....	418	Convertible Top	179	Tailgate Latch	651
Removal Tool, Handle Clip.....	611	Fin Corner	45	Trunk Hinge Torsion.....	168
Repair		Shift Linkage	524	Tumbler, to Door Latch & Clips	614
Automotive Bodywork & Rust Book ..	671	Headlight Switch	75	Roll Stop Kit	461
Centerlink	421	Nut, Headlight Switch	274		
		Stud, Spare Tire.....	167		

Roller(s)			
Application Tool, Dynamat	160		
Bearing Conversion.....	422, 476		
Emergency Brake	473		
Front Bearing Conversion Kits	422		
Guide, Window & Related	636		
Rubber, Dynamat	161		
Window Regulator	624		
Roof			
Braces	590		
Insulation.....	158		
Panel.....	590		
Rails & Stops.....	645, 591		
Rotor(s)			
Brake.....	458, 466		
Distributor, & Cap, MSD	267, 272		
Power Steering Pump & Vane	416		
Stock Spindle Brake	458		
Rubber			
Brake Hole Adjustment Plug	467		
Bumper(s)	619		
Bullets	50		
Gas Door	314		
Kits.....	280, 645		
Liftgate Stop.....	649		
Rear Axle.....	431		
Tailgate	654		
Trunk	168		
Cowl Top Outer Corner Bumpers	283		
Cushions	491		
Front Disc Brake Hose Kits	468		
Gear Shift Grommet	400		
Inserts, Gas Pedal	155		
Insulator			
Trunk Torsion Spring	168, 180		
Muffler Hanger.....	358		
Pad(s)			
Armrest	128		
Battery	236		
Turn Signal Bushing	401		
Plug, Rear Door	619		
Radiator Core Support Cushions	384		
Replacements, Floor Mat	165		
Retainers, Nomad & Wagon Liftgate..	649		
Shock Mount And Hardware Kits	434		
Spark Plug Wire	273		
Trunk	167		
Window Roller	636		
Rubberized, Clamp Kit	467		
Runners			
Window.....	626		
Russell Performance	300-301		
S			
S-Blade Electric Fans.....	375		
S-Drive Pulley Systems.....	508		
Saginaw Power Steering Pump			
& Related.....	411-412, 415-416		
Sail Boards Cardboard.....	163		
Savers, Wiper	631		
Screen, Radiator Bug.....	384		
Screw(s)			
Accessory Bumper Guard	52		
Armrest.....	129		
Back-Up Light Lens.....	76		
Brake Adjusting Springs.....	469		
Brake Adjusting	470		
Carburetor	317		
Cargo Floor Trim.....	595		
Clip, Grille and	29		
Convertible Sunvisor.....	180		
Convertible Top Latch Plate.....	178		
Cowl Vent	283		
Door			
Belt Moulding	619		
Hinge to Pillar.....	617		
Inner Mechanism	619		
Lock Catch Mechanism	612		
Striker.....	616		
Weatherstrip Retainers and	620		
Window Moulding	625		
Emergency Brake Bracket	473		
Fast Idle	319		
Fin Moulding	45		
Fin Moulding & Gas Door Box.....	45		
Flipper Channel	618		
Front End Sheet Metal.....	604		
Front Seat Floor Clip	133		
Fur Channel Kit	626		
Gas Door	314		
Gas Tank Sending Unit	311		
Glove Box and Hinges.....	122		
Headlight	71		
Heater Motor Mounting.....	366		
Hood Brace & Latch	289		
Hood Latch	290		
Horn	275		
Horn Ring Center Cap.....	96, 398		
Ignition Coil Bracket Clamp	264		
Inner Quarter Window	638		
Instrument Cluster	101		
Interior Trim	147		
License Light Housing	81		
Liftgate	649		
Nomad Window.....	648		
Parklight	76		
Rear Door Hinge	617		
Rear License Plate	57		
Rear Quarter Belt Moulding.....	45, 180		
Tailgate	654		
Tailgate & Bolts	654		
Tailgate Hinge to Body.....	654		
Taillight.....	76		
Timing Cover.....	495		
Upper Trunk Latch Plate	169		
Valve Cover.....	296		
Vent Cable to Dash.....	371		
Vent Window Frame & Assembly	642		
Voltage Regulator	275		
Window Regulator	624		
Windshield Pillar.....	631		
Wiper Motor & Driver Mounting.....	633		
Wire Harness Door Sill Cover	143		
Screwdriver	371, 692		
Script(s)			
Bel Air	91		
Chevrolet, Dash.....	91, 102		
Fuel Injection	22		
Bel Air or Chevrolet	21		
Chevrolet.....	20		
Custom Dash	23		
Dash, Custom	23		
Nomad Tailgate.....	22		
Speaker Plates.....	92		
Scuff Pads, Fender Skirt	551		
Seal(s)			
Air Cleaner Oil Reservoir	328		
Air Duct-to-Inner Fender	371		
Air Vent.....	371		
Axle Flange	431		
Back Body-to Bumper.....	54		
Differential Pinion	431		
Door	644-645		
Door Drain.....	643		
Felt Floor	402, 525		
Fender, Inner.....	550, 606		
Fender-to-Fender Skirt.....	551, 606		
Firewall Retainer Clips.....	95, 278, 403		
Firewall To-Hood	280		
Flipper	619		
Front Wheel Bearing And Oil	422, 476		
Headlight	68-69		
Heater	365		
Heater Blower Motor.....	366		
Heater Defroster.....	371		
Kick Panel Vent Door.....	371		
Liftgate and Tailgate.....	644, 652		
Parklight Housing.....	68		
Quarter Glass & Side	643		
Rear Glass Drain	635		
Rear Main	499		
Rear Quarter Glass	647		
Rear Side Glass	643		
Rear Window	643		
Splash Pan, Front	540-541, 606		
Steering Column	401-402		
Taillight Assembly	68		
Taillight Housing	68		
Taillight Housing-to-Body.....	67		
Trunk	644		
Vent Window.....	642		
Vertical Slider	642, 645		
Vertical Window	642		
Wheel Housing.....	598, 606		
Window.....	627, 630, 642		
Window Gutter			
Inner Cowl Panel Drain	630		
Windshield & Related			
.....	631, 696, 703, 707		
Sealant			
Auto Glass & Auto Body.....	680		
High Temp Thread.....	684		
Hose & Fitting Assembly Kit.....	692		
Sealed Beam Headlight.....	71		
Seat Panel Cardboard, Rear	183		
Seat(s)			
Adapter Bracket, for Procar	141		
Adjuster Bezel	134		
Adjuster Escutcheon & Knob.....	134		
Adjustment Knob	134		
Back Stops.....	133, 174		
Back Trim.....	172		
Belt(s)	130-132		
Bolts.....	174		
Braces	562, 575		
Bracket Retainers, Front	133		
Button, Silver	133		
Cardboard Panels.....	164, 182		
Divider	135		
Floor Bracket.....	563		
Floor Clip Screws	133		
Floor Mounts	563		
Floor Pans.....	576		
Floor Pockets.....	563		
Foam	136		
Forward Stop Brackets.....	134		

Frame Assembly.....	137	Heat	302	Signal,	
Frame Covers.....	135	Heat, Power Steering.....	355	Bushing/Rubber Pads	401
Front, Cushion Mouldings	134	Lower Ignition Wire Support	262	Pawl Kit	399
Hinge Covers	174	Radiator Splash, Lower Front	545	Switch with Wiring	401
Latch & Related.....	174, 645	Spark Plug Boot.....	266, 273	Outside, Rear View Mirror	46
Mounting Kit	131	Splash	545	Turn & Related.....	275, 399, 401
Panel Cardboard, Rear.....	183	Starter Heat.....	242	Signs.....	706, 708
Plates	133	Taillight Dust	67	Sill	
Power, Switch	134	Wiring Harness, Steering Column.....	402	Covers.....	565
Power, Track Assy.....	135	Shift		Nomad.....	173
Procar.....	140	Adjustable Transmission Arm.....	403	Plates & Related	142-143
Rear Mat	165	Arm Pin	400	Eddie Motorsports	143
Rear Door Panel Retainers	564	Column Lever Linkage Bushing.....	407, 523	Skid Plates, Convertible Frame Rail.....	601
Reels	132	Detents, Powerglide.....	523	Skin(s)	
Riser Brackets	177	Gear Arm.....	399	Door	561, 563
Riser to B Pillar Support Braces	574	Gear Knob.....	399	Outer Trunk Lid.....	583
Shells & Related	134	Gear Lenses.....	408	Tailgate	593
Spring Assembly	137-138	Grommet, Gear	400	Window Patch Panels	565
Supports, Floor.....	576	Indicator Lenses,		Skirts	
Support Springs.....	139	Column Mounted.....	83, 99	Fender & Related	551
Tracks	135	Indicator Spring Bracket.....	83	Seals	606
Secret Audio, Stereo System.....	257	Indicator Wire Rods.....	523	Sleeve(s)	
Selector, Classic Instruments Gear	112	Knobs	407, 529	Accelerator Linkage.....	324
Sender(s)		Lever Spring, Gear	401	Clutch Pedal Cross Shaft	524
Adapter Kit, Engine.....	104	Linkage & Related	523	Fresh Air Inlet.....	371
Classic Instruments.....	112, 115	Adjustable Steering Column	403	Generator Mount Bushing	241
Fuel, Universal	107	Adjustment Swivel Nut.....	409, 523	Heat, Thermo-Tec.....	302
GPS Antenna Speedometer	253	Bell Crank Bushing.....	524	Tie Rod Adjustment.....	424
Oil Pressure.....	115, 121	Hardware Kits	524	Tube	301
Speedometer, Auto Meter.....	108	Retaining Clips.....	524	Slider	
Temperature	103	Spring Bracket	99	Brackets, Window Fur Channel ..	646-647
Water Temperature	115	Muscle Car Knob Adapters	528	Glas Edge Trim	628
Water Temperature & Oil Pressure,		Steering Column Collar.....	402	Glass Channel Locating Clips	647
Dakota Digital	121	Shifter(s)	528-529	Glass Mouldings.....	646
Sending Unit.....	103, 369	Boot Kits.....	529	Latches, Glass	647
Float	311	Knob Adapters.....	530	Seals, Vertical	645
Gas Tank & Related	310	Shim(s)		Windshield Wiper Motor.....	632
Gasket.....	311	Body Mount.....	605	Smoothie	
Oil Pressure	499	Door Striker	616	Bumpers	48
Temperature Insulators.....	369	Radiator Support to Fender &		Bumper Mounting Kit.....	53
Sensor Leads, Speedometer.....	522	Frame	384	Firewall.....	553
Shackle Kits, Rear Spring & Bushings ..	431	Starter & Bolts.....	242	Hood Assembly.....	537
Shaft		Water Pump Pulley.....	503	Snaps	
A-Arm & Related.....	426-427	Shirts.....	696-702	Convertible Top Boot	179
Bushing Kit, Clutch Cross	525	Shock(s)	436	Thermo-Tec Strap Kit	360
Carburetor	316	Absorbers.....	435, 437	Snub Nose Screws	
Clutch Cross	525	Bearing Mount Kits	427, 437	Horn & Voltage Regulator.....	275
Clutch Pedal & Related.....	524-525	Conversions, Coil Over	436	Snubber Bracket, Rear End	429, 583
Felt Washer, Clutch Cross	525	Covers, Nomad & Wagon	174	Socket(s)	
Headlight	93, 274	Cross Members	435	Head Plugs.....	367
Nut, Steering Wheel	400	Leaf Spring & Related	433	Instrument Cluster	101
Nylon Bushing, Brake Pedal.....	467	Mount Rubber And Hardware Kits.....	434	Pipe Plugs.....	300
Oil Pump Drive	498	Mounting Studs	434	Tool, Crank Turning	501
Switch, Convertible Top	179	Supports, Trunk Floor	579	Softline, Notched Clamp Kits.....	475, 693
Throttle.....	319, 321	Shoes, Brake.....	466, 472	Solenoid(s)	
Trunk Lock	613	Shoulder Bolt		Fuel Shut Off.....	346
Turn Signal Chrome.....	399	Power Steering.....	420	R Terminal Diode Kit	242
Yokes, Drive.....	513	Treadle-Vac Plunger Rod.....	465	Starter & Related	242-243
Sheet Metal		Shrouds, Fan.....	372, 377	Throttle.....	321, 340
Fasteners & Screws ..	534-535, 540-606	Side		Spacers	
Front End Fasteners	604	Cardboard Panels.....	162	Air Cleaner	328
Handbook.....	670	Extension Hingemounts, Cowl	555	Bumper End	54
Packages, Front End.....	534, 535	Filler Panels	544	Continental Kit Bar	58
Shells, Seat & Brackets.....	134	Moulding Clips	60	Clutch Pedal Cross Shaft	524
Shelves, Package.....	182	Mouldings	36, 38, 39-41, 45	Exhaust Heat Riser.....	354
Shield(s)		Mount Conversion Kits.....	511	Fan.....	374
A-Arm Dust & Related	282, 427	Engine	491-492	Window Pillar Caps	627
A-Arm & Retainers	426-427	Panel Inserts	43	Wiper Transmission	634
Gravel.....	35	Panel, Cowl	555		
		Window Moulding Clips	59		

Spare Tire		Hub Kits.....	397
Covers.....	691	Nut.....	400
Lid Lift Ring.....	171	TMI.....	187
Retainers.....	167	Stems, Valve.....	483
Retaining Bolt & Studs.....	167	Stencil, Chevrolet Valve Cover.....	296
Stainless Trim.....	170	Stereo	
Well & Related.....	283, 596, 604	Amplifier & Speakers.....	255
Plug.....	167	Custom Autosound.....	257-259
Spark Plug		Stools, Bel Air Counter.....	704
Boot Heat Shields.....	266, 273	Stop(s)	
Wire Mini Stripper Crimper, MSD.....	268	Bolts.....	288
Wire Rubber Separator Grommet.....	273	Bumper, Rear Quarter.....	638
Wire Linear Looms.....	263, 273	Division Bar Channel.....	634
Wires.....	262, 265-266, 268, 272-273	Door Flipper.....	618-619
Wires Support Shields.....	262	End, Windlace.....	148
Speaker(s).....	255-257	Gas Door.....	314
Bezel.....	92, 101	Hood.....	285, 288
Boot, Radio.....	254	Liftgate Rubber Bumpers.....	649
Brace.....	255	Light Switch.....	274, 470
Cover Insert.....	88	Plates.....	133
Grille.....	256	Quarter Glass Track.....	635
Grille Clips, Radio.....	89	Race Ramps Trak-Jax.....	688
Grille Cover.....	89	Rear Quarter Window.....	638
Mask.....	89	Roll.....	461
Plate.....	92	Seat.....	133-134, 174
Speed		Window, Upper.....	637
Bleeders.....	465	Bottoming.....	637
Nut, Winged.....	28,59	Strap(s)	
Speedometer(s)		Anchor Bracket Kit.....	308
Cable Grommet.....	280, 282	Convertible Top.....	179
Cables.....	522-523	Engine Ground.....	239
Classic Instruments.....	114	Gas Tank Mounting & Related...306-307	
Cluster Bezels.....	101	Pull & Tips.....	182
Converter.....	522	Radiator.....	542
Cover Inserts.....	293	Radio Ground.....	239, 254
Engine Covers.....	293	Taillight Mounting.....	67
Gears.....	522	Thermo-Tec Snap Kit.....	360
GPS.....	253	Striker	
Interface, Dakota Digital.....	121	Cover, Tailgate.....	652
Lenses.....	83	Hood Latch.....	290
Masks.....	89	Liftgate Trim.....	648
Sender, Auto Meter.....	108	Plates, Convertible Top.....	178
Sensor Leads.....	522	Plates, Door & Related.....	616
Spin-On Oil Filter Conversion.....	499	Strip(s)	
Spindles		Crimp Tool, Taylor.....	266
Brake Kits.....	453, 458	Convertible Top & Related.....	177-178
Dropped & Bolts.....	458	Door Attaching.....	620
Spinner		Door Panel Attaching.....	147
Cragar Wheel Center Caps.....	481	Fur, Nomad.....	646
Emblems.....	22	Track.....	148
Wheel Cover Assembly.....	477	Tack, Convertible Top.....	176, 178
Splash		Stud(s)	
Pan Center Support Bracket.....	541	Air Cleaner.....	328
Pan Seals, Front.....	540-541, 606	Billet Specialties Valve Cover.....	297
Pan to Fender Retainers.....	545	Carburetor.....	317
Panels, Trunk & Brace.....	581	Clutch.....	525-526
Shields.....	545	Distributor Hold-Down.....	265
Radiator.....	545	Exhaust Manifold.....	356, 359
Spray, Aluminum Pre-Clean.....	679	Fuel Injection Bracket.....	346
Spreader, Parking Brake Bar.....	470	Intake Manifold.....	322
Spring(s).....	288	Intake Thermostat Housing.....	322
Assist, Edelbrock Step Up.....	340	Leaf Spring Plates Mount.....	433
Brake & Related.....	466-467, 469	Oil Pan & Pump.....	497, 498
Carburetor/Accelerator Linkage.....	325	Pitman Arm Ball.....	410
Carburetor Return.....	317	Retaining, Spare Tire.....	167
Clutch Linkage.....	526	Shock Mounting.....	434
Clutch Pedal Return.....	526	Transmission Kickdown.....	531
Coil.....	434	Water Outlet Kit.....	369
Continental Kit Ring.....	58	Wheel Lug & Nuts.....	478
Emergency Brake Linkage Return.....	473		
Fast Idle.....	319		
Flipper.....	618		
Gas Door.....	314		
Gas, Hood Hinge.....	285		
Gear Shift Lever.....	401		
Handle.....	611		
Headlight.....	71		
Heater Lever.....	363		
Hood.....	288		
Hood Latch.....	291		
Idle & Screw.....	319		
Indicator.....	99		
Leaf & Related.....	431, 433-434		
Locating Pocket Kit, Rear.....	430		
Retainer, Lock Bolt.....	58		
Rubber Insulator.....	168, 180		
Seat.....	138-139		
Shackle Bushings.....	431		
Steering Column.....	402		
Tailgate Wedges.....	654		
Trans Indicator Return.....	83		
Trunk Lock Return.....	167		
Trunk Lock Shaft Retainer.....	613		
Square Drive Balancer Bolt.....	500		
Sta-Lube Oil Pump.....	680		
Staples, A-Arm Dust Shield.....	282, 427		
Starter			
Bolts.....	242		
Brush.....	242		
Fasteners.....	241		
Grommet.....	283		
Ground Washer.....	237		
Harness Grommet.....	280		
Heat Shield.....	242, 302		
Plate, Engine.....	522		
Solenoid.....	242-243		
Steering.....	424		
Amsoil Synthetic Fluid.....	687		
Arms.....	421		
Box & Related.....	402, 409-410		
Bracket.....	407		
Bushing Bearing Kit.....	402		
Column & Related.....	400-409		
Dash Cushion.....	401		
Fasteners.....	403		
Firewall Mount Plate.....	403		
Firewall Seals.....	401		
Floor Mounts.....	402		
Hoses & Related.....	409		
Hub Kits.....	393		
Idler Arm.....	420		
Seals.....	402		
Shift Collars.....	402		
Spring Assembly.....	402		
Tanged Washer.....	400		
Upper Mounting to			
Dash Support Kit.....	400		
Washers.....	400		
Connecting Rod Dust Covers.....	421		
Manual.....	421		
Pitman Arm & Related.....	410-411		
Power & Related.....	410-412, 415-420		
Power, Pumps & Pulleys.....	413-414		
Rag Joint.....	410		
Seals.....	401		
Spring.....	402		
Wheels & Related.....	392-397		
Horn Adapter.....	397		

Sunvisor(s) & Related.....	180	Retainer Nut, Wiper	633	Coolant Overflow	386
Brackets.....	127	Stop Light	274, 470	Filler and Vent Hose Kit.....	308
Convertible	126	Torque Connector Lock-Up	275, 515	Filler Pipe Hose Clamps.....	308
Perforated Vinyl	126	Turn Signal.....	401	Filler Tubes, Fuel	309
Trim	127	Wiper Control Cable Assembly	633	Fuel	306
Upholstered.....	126	Swivel		Gas & Related.....	304-306
Support		Couplers.....	300	Filler Pipe Hose.....	308
Assembly Pad	58	Hose Ends.....	301	Mount	307
Bar, Grille.....	31	Thermostat.....	369	Mounting Straps.....	307
Bars, Radiator Core	542-543	Shift Linkage Adjustment Nut	409	"O" Ring	308
Bolt, Seat.....	174	Syringe, Brake Bleeding	465	Pipe Support Bracket.....	308
Braces				Screws	311
Hood, Eddie Motorsports	287	T		Locator Kit	307
Quarter Panel.....	589	Tabs, Liftgate	649	Mounting Strap Bolts.....	306
Seat Riser.....	574	Tabs, Timing.....	495	Sending Unit	310-311
Bracket(s)		Tachometers		to Body Grommet.....	308
Air Cleaner.....	328	Auto Meter	104	Tapered Port Carb Adapter.....	339
Front Fender	550	Classic Instruments.....	114-115	Taylor Battery Boxes.....	234
Gas Tank Pipe.....	308	Tacking Strips, Convertible Top	178	Taylor Ignition Wires & Related	266
Grille Bar.....	28	Tag(s)		TC Power Steering Pump	
Inner Fender Extension	47	Body by Fisher Sill Plate.....	143	& Related.....	412-413, 416, 418
Sunvisor	127	Cowl, Rivets	283	TCI	
Cargo Floor Baffle Set.....	595	Delco-Remy Detail	243	Drain Plug Kit.....	513
Convertible		Electro-Vac.....	671	Flexplate	488
Backrest Bracket.....	600	Tail Panel Brace, Nomad & Wagon.....	594	Roll Stop Kit.....	461
Inside Mirror.....	180	Tail Pipes		Transmission Cooler.....	517
Lower Trunk Lid Hinge Braces	583	Flowmaster.....	355	Transmission Fluid	681
Fender.....	548	Tailgate.....	593-594	Transmission Pans.....	516
Grille Bar to Fender Brace.....	549	Access Cover	171, 174, 654	Tee Shirts, Danchuk.....	698
Hood Latch	290	Bolt and Screw Kit	654	Tee Shirts, Tri-Five	699-702
Idler Arm Bushing.....	423	Bumper Bracket Assembly	654	Temperature	369
Liftgate.....	648	Cables & Retractor	653	Electric Fan Switch	375
Mirror	124	Clips, Nomad.....	651	Gauges, Classic Instruments	114
Outer Wheel Well	601	Covers.....	650	Sender.....	112
Radiator.....	384, 541-544	Fastener Set.....	654	Sender, Water	121
Rear Floor Seat.....	576	Handle.....	651	Sending Unit	
Seat Spring	139	Hinge.....	650	Wire Insulators	369
Shock	579	Covers	650	Sending Units & Fittings.....	103
Spark Plug	262	to Body Screws	654	Tensioner Cover Kits, Front Runner.....	505
Steering Column	400	Trim	594	Thermo-Tec Products .. 157, 242, 302, 360	
Tailpan.....	594	Latches.....	651	Thermostat(s) & Related.....	368-369
Trunk Floor Shock	579	Nomad Clips.....	55	Fan	368
Suspension		Nomad Script	22	Harness	368
Front Fastener Kit	422	Nomad Vees	54	Housings.....	369
Rebuild Kits	425	Rods & Clips.....	651	Bolts	369
Rear 4-Link Kit.....	430	Rubber Bumper	654	O-Ring	369
Sway Bars & Related.....	438-441	Screws	654	Studs, Intake	322
Roadster Shop	446	Seals	652	Swivel	369
Switch(es)		Stainless Trim	173, 651	Third Brake Light Assembly	68
Back Plate.....	92	Striker & Related	652	& Harness	68
Back-Up Light	78, 275, 532	Wedges with Springs	654	Thread	
Blower	275, 366	Window Retainer Clips.....	649	Lockers.....	684-685
Convertible Top & Related	179	Tailight(s) & Related	67	Sealant	684
Cover	80	Assembly	62-63	Throttle	
Cruise Control Dash Mounted	252	Curved J-Nut, Lower.....	62	Arms.....	319
Dimmer & Related.....	157, 276, 578	Housing & Related	62-63, 67-68	Body Kit, MSD Atomic EFI.....	347
Dome Light	274	Lenses & Related	64-67	Brackets.....	318, 532
Electric Fan.....	374-375	Reflector LED Kit	62	Cable Bracket & Spacer.....	340
Emergency Brake Indicator Kit	471	Reflectors, Under	62	Cable Brackets.....	320, 530
Glove Box Light.....	123, 275	Screws	76	Cables, Lokar.....	318, 530
Headlight & Related.....	75, 274, 631	Seals	68	Controls	320
Ignition, Bezel & Nuts	90, 262-263	Under Emblems.....	22	Pedal	320
Intermittant Delay	633	Tailpans & Related.....	594	Plates	319-320
Master Disconnect	238	to Quarter Filler Panels.....	589	Shafts.....	319
Neutral Safety	276	to Quarter Panels	581	Solenoid.....	340
Nut Tool.....	275	Tailpipes & Related	358-359	Bracket Kit	321
Overdrive Wire Harness Plug	530	Tank		Transmission Cable Extension Kit	514
Power Seat.....	134	Centering Kit	306	Universal Cable.....	530
Power Window & Related	624				

Tie			
Bar Grille, Brackets.....	30		
Brass Wire.....	308		
Rod & Adjustment Sleeves			
Bar, Grille & Related.....	31		
Rod & Related.....	423-424		
Timing Chain & Related.....	495		
Tips			
Exhaust.....	357		
Pull Straps.....	182		
Pypes Exhaust.....	357		
Tire			
Rings, Continental Kit.....	58		
Spare & Related			
167, 170-171, 173, 596, 604, 691			
Whitewall.....	484		
Tissue Dispensers.....	123		
TMI Upholstery.....	184-187		
Toe Board Panels & Floor Pans.....	578		
Tone Control Knobs, Radio.....	254		
Tool(s).....	371, 692, 694		
Application Roller.....	160		
Battery Cable Crimping.....	237		
Crank Gear Installation.....	500		
Crank Turning Socket.....	501		
Firewall Pad Grommet Installation.....	95		
Handle Clip Removal.....	611		
Harmonic Balancer Installation.....	500		
Headlight & Wiper Switch Nut.....	631		
Tool Headlight Switch Nut.....	631		
Ignition Ring Nut.....	90		
Light & Wiper Switch Nut.....	275		
Prop Valve.....	459		
Strip & Crimp Taylor.....	266		
Winged Speed Nut Fastening.....	28, 59		
Wiper Escutcheon Nut.....	631		
Top			
Convertible & Related.....	175-179, 181, 630		
End Kit Edelbrock.....	489		
of Fin, Moulding & Related.....	44-45		
Torque			
Converter Lock Up Kits & Switch.....	275		
Converter Lock-Up Kits.....	515		
Starters.....	243		
Torsion			
Bars, Rear Door.....	168, 646		
Spring Rubber Insulator.....	168, 180		
Trunk Hinge Rods.....	168		
Track(s)			
Assembly, Power Seat.....	135		
Convertible Quarter Window.....	639		
Fur Channel.....	626		
Glass & Guides.....	635-636, 639		
Strip Sets.....	148		
Strips, Convertible.....	176		
Traction Bars.....	428-429		
Traffic Light Viewers.....	124		
Trailer			
Hitch Cover.....	708		
Ramps.....	689		
Transfer Hose, Fuel.....	308		
Transmission			
Amsoil Flush.....	685		
Amsoil Synthetic Fluid.....	687		
California Performance.....	513		
Cable Extension.....	514		
Center Panel.....	576		
Clips, Fittings.....	517		
To Frame Bolts.....	510		
Controller.....	514		
Controller & Harnesses, MSD.....	514		
Coolers & Related.....	517-519		
Cross Members &.....	512		
End Brackets.....	512		
Dipsticks.....	494, 520-521		
Fluid, TCI.....	681		
Indicator Lenses.....	83, 99		
Indicator Return Spring.....	83		
Inspection Plate Cover.....	515		
Kickdown Lever Assembly.....	532		
Kickdown Stud.....	531		
Linkage Grommets.....	524		
Lokar Billet Adjustable Shift Arm.....	403		
Mounts.....	510		
Oil Cooler Lines & Related.....	517		
Pan Bolts - ARP.....	516		
Pans.....	516		
Pans & Related.....	516		
Side Mount Conversion Kit.....	511		
& Hardware.....	510		
Service News Manuals.....	664		
Wiper.....	633-634		
Tray			
Milodon Oil Pan Windage.....	496		
Car Hop.....	704		
Treadle-Vac			
Plunger Rod Shoulder Bolt.....	465		
Power Brake Hose Bracket.....	465		
Vacuum Hoses.....	465		
Trim			
Cargo.....	171		
Cargo Floor.....	595		
Dash.....	86, 88		
Door Panel Joiner Clips.....	147		
Inner Quarter Garnish.....	181		
Interior Door Panel Joiner Clips.....	620		
Interior Screw Set.....	147		
Inner Tailgate.....	171		
Kit, Accessory Rear Deck.....	41		
Kit, Cargo.....	174		
Kit, Door Panel.....	145, 620		
Kit, Trunk.....	41		
Nomad...170, 174, 646, 648, 650-651			
Paint Divider Filler.....	646		
Rally Wheel Rings.....	478		
Seat.....	172		
Seat Divider.....	135		
Sunvisor.....	127		
Tailgate Hinge.....	594		
Windshield to Dash Garnish.....	147, 628		
Trunk			
Battery Boxes.....	234		
Brake Light.....	68		
Cardboard Panels.....	164, 182-183		
Clips.....	167		
Cushions.....	57		
Torsion Rods.....	168		
Area Inner Access Plug.....	167, 604		
Bumper Kit, Upper & Lower.....	167		
Emblems.....	18-19		
Filler Panel Brace, Rear Window.....	579		
Floors & Related.....	571-572, 579-580		
Hinges.....	169, 286		
Insulation Kit.....	158		
Latch			
Assembly.....	169		
Mount Bracket.....	583		
Plate Screws.....	169		
Lid(s) & Related.....	582-583		
Alignment Kit.....	167		
Hinge Assy, Convertible.....	179		
Hinge Support Braces.....	583		
Insulation Kit.....	167		
Latch Plate Bolts.....	169		
Light Kit.....	79, 168		
Liner Kits.....	166		
Locks & Related.....	613		
Mats.....	166		
Mount			
Battery Boxes.....	234		
Battery Cables.....	237		
Package Shelf Panels.....	592		
Panel Kit, Custom.....	163, 183		
Panel to Rear Window.....	591		
Pin.....	169		
Prop Rods, Self Locking.....	168, 289		
Rubber Bumper.....	167		
Seals.....	644		
Splash Panels.....	581		
Splash Panels & Braces.....	581		
Torsion Spring Insulator.....	168, 180		
Trim Kit.....	41		
Vees.....	54		
Tub			
Mini.....	599		
Wheel, Trunk Floor.....	572		
Tube			
Air Duct Drain.....	371		
Air Inlet Grommets.....	371		
Carburetor Vent.....	316		
Choke Heat Riser.....	321		
Fuel Tank Filler.....	309		
Gas Tank Filler "O" Ring.....	308		
Hardline Pressure.....	416		
Heat Kit, Carburetor Choke.....	321		
Nuts.....	301		
Oil Dipstick.....	494		
Oil Filler.....	499		
Radio.....	254		
Sleeve.....	301		
Transmission Dipstick.....	520		
Tubular			
A-Arms.....	426-428		
Anti-Sway Bars.....	440-441		
Classic Performance Traction Bars.....	428		
Transmission Cross Member.....	512		
Tune-Up Kit, Pertronix Flamethrower.....	272		
Turn Signal & Related			
Bushing and Rubber Pads.....	401		
Canceling Cams.....	401		
Flasher.....	275		
Housing Lock Plate.....	399		
Knob.....	399		
Mechanism.....	399		
Pawl Kit.....	399		
Shaft.....	399		
Switch.....	401		
Tuned Port Brackets.....	320		
Twelve-Point Plug.....	367		
U			
U-Channel Guide.....	627		
U-Joint			
Power Steering Column.....	411		
Steering Column.....	408		
Under Cover Speakers.....	256		
Under Hood Covers.....	158		

Under Seat
 Braces, Floor 575
 Under Taillight 67
 Reflectors 62
 Under Trunk Insulation & Covers 158
 Underhood Light Kit 168
 Universal
 Auto Meter Wire Harness 108
 Choke Cable Kit 322
 Coil Bracket 268
 Dust Cover 513
 EFI Sump Fuel Kit 344
 Fuel Sender 107
 Gauge Disconnect Kit 102, 238
 In-Tank Fuel System 331
 Joint 513
 Moulding Clips 59
 Parking Brake Cable Mount Kits 470
 Peronix Plug Wires 273
 Spark Plug Wires 273
 Throttle/Valve Cable 530
 Wilwood Master Cylinder Pushrod 456
 Urethane
 Anti-Sway Bar Link Kit 436
 Body Mounts 605
 Spring Shackles Bushing Sets 431
 Replacement Ball Joint Boot 423
 Tie Rod End Boots 423
 Transmission Mounts 510
 Upper And Lower A-Arm Bushings 426

V
 Vaccum
 Advance & Related 269, 272
 Hoses
 Clamps, Brake 465
 Fittings 322
 Nipples 322
 Treadle-Vac 465
 Lines, Distributor 265
 Wiper Motor Gaskets 633
 Valve
 Air Cleaner Braces 297
 Baer Remaster Proportioning 463
 Billet Specialties 299
 Bolts 296
 Breather Cap Grommets 298
 Cable Brackets 530
 Choke Shaft 321
 Chrome Stems 483
 Conversion Kit 297
 Covers 292-294, 297
 Breather 299
 Breather Cap 298
 Oil Filler Cap 298
 Stencil 296
 Gas Filler Neck & Check 308
 Heater Control 363
 Hold-Down Clamps 297
 Master Cylinders 462
 Oil Filter Bypass Kit 499
 Power Steering & Related 415, 417, 419
 Proportioning & Related 459
 Residual Pressure Check 460
 Screws 296
 Universal Cable 530
 Wilwood 456-457
 Wing Nuts 296

Vane Rotor Kit,
 Power Steering Pump 416
 Vanity Visor Mirror 125
 Vees
 Hood 34
 Nomad Tailgate 54
 Trunk 54
 Vent
 A/C Dash 91
 Cable to Dash Screw and Washer 371
 Cowl Grille Panel 555
 Cowl, Grommets & Screws 283
 Fresh Air 370
 Handles 608
 Hose 308
 Kick Panel Door Seals 371
 Line, Fuel Injection 348
 Outer Window Frames 640
 Pull Knobs 89
 Rear Axle 431
 Tubes, Carburetor 316
 Window
 Assemblies 640
 Assembly Bolts 642
 Crank Handles 609-610
 Frames & Related 641-642
 Latch Assembly 641
 Power Conversion Kit 623
 Regulators 622
 Seals 642
 Window Channel Kit 641
 Vertical
 Fin Mouldings 44
 Slider Mouldings & Seals 645-646
 Vent Window 641
 Window Seals 642
 VHX Dakota Digital 118-119
 Vibrator
 Radio Tube 254
 Vibro Solutions Insulation 159
 Victory Pulley Systems 509
 Viewers, Traffic Light 124
 Viking Shocks 437
 Vintage Air 505
 Visors, Windshield 555, 628
 Voltage Regulator 241
 Screws 275
 Voltmeters 114

W
 Wagon/Nomad 147, 174, 643, 646-654
 Wall Guard 688
 Warning Emergency Brake Kit 470-471
 Washer(s)
 & Bolts, Body Mount 604
 A-Arm 427
 Battery/Starter Ground 237
 Clutch Cross Shaft Felt 525
 Differential Carrier & Nuts, Copper ... 432
 Door & Window Handle, Plastic 611
 Exhaust Manifold Bolts and 356
 Fender To Cowl Bracket 283
 Hood 289
 Idler Arm 422
 Intake Manifold 323
 Interior Screw Set 147
 Master Cylinder Copper 464
 Pitman to Steering Box Lock 411

Steering Column Felt 400
 Steering Column Tanged 400
 Steering Column Thrust 400
 Timing Chain 495
 Under Steering Wheel Nut 400
 Valve Cover 296
 Vent Cable To Dash 371
 Windshield Wiper Control 631
 Water
 Neck Bolts 369
 Pulley Shims 503
 Pumps & Related 502-504
 Temperature Gauge 114
 Temperature Sender 121
 Wax
 Danchuk Vintage 674, 675
 Flitz Speed Spray-On 679
 Protectant 679
 Weatherstrip
 Adhesive 644, 677
 Channel Mouldings 631
 Convertible Top 181
 Liftgate 652
 Retainer, Quarter Window 638
 Retainers & Screws, Door 620
 Wedges, Tailgate, w/ Springs 654
 Well
 Convertible Outer Wheel 601
 Moulding Clips 177
 Plug, Spare Tire 167, 604
 Spare Tire & Related 283, 596
 Wheel & Related 170, 588, 598
 Wheel(s) 477-478
 American Legend 482-483
 Bearings 422, 431
 Grease 680
 Cargo Trim 174
 Center Cap 478
 Chrome Installation Kit 483
 Covers & Related 479
 Cragar 481
 Cylinder Push Pins 467
 Cylinders, Brake 466
 Front Bearing And Oil Seals 476
 Grant Steering Installation Kits. 395-396
 House Extensions 597
 Housings & Seals 597-598, 606
 Lock Set 483
 Lug Nut & Stud 478
 Nut Washer 400
 OE Disc Brake 476
 Seals 598
 Spinner Emblems 22
 Steering & Related ... 392-394, 397, 400
 Tubs, Trunk Floor 572
 Well & Related 163, 170, 601, 588, 598
 Wire Hubcap Retainer Clips 480
 Whitewall, Tires & Related 484
 Wilwood
 Brake Fluid 457
 Disc Brake 454-455, 457
 Emergency Brake Cable Kit 471
 Master Cylinders 456
 Residual Pressure Valves 456
 Universal Master Cylinder Pushrod 456
 Proportioning Valves Combo 457
 Windage Tray, Milodon Oil Tray 496
 Windlace 148
 Nomad Interior Garnish 647

Window

Adjusting Plate & Hardware	627
Adjusting Plate, Quarter.....	638
Buttons & Switches, Power	623-624
Channel Adjusting Seals	627
Channel Kits, Vent Delete	641
Clips, Nomad"	647
Connectors	625
Conversion Kits, Power	623
Door	619
Front, Adjusting Plate Set	627
Moulding Screws	625
Upper Moulding Clips	620
Frame	
Cap, Vent.....	642
Door	628
Lock & Pivot Bracket Rivets.....	642
Quarter & Vent	641
Screws, Inner, Nomad.....	648
Screws, Side & Vents	642
Vent	641
Fur Channel & Related	618, 626, 646
Gasket Channel.....	592
Gutter Inner Cowl Panel	
Drain Seals.....	630
Handles & Related	608-611
Latch Assy, Vent.....	641
Latch Bumpers	645
Moulding Clips & Connectors	60, 625
Moulding Connectors.....	59
Mouldings, Rear.....	628-629
Clips	625
Corner	626
Upper.....	629
Windshield Connectors.....	630
Pillar Spacer Caps.....	627
Pivot Assembly, Quarter,	
Convertible	638
Power	623-624
Quarter & Related	638-639
Reinforcement Brace.....	591
Regulator & Related	622
Roller and Rivets.....	624
Screws	624
Relining Kit.....	627
Retainer Clips, Tailgate.....	649
Rivets, Quarter Window.....	638
Roller Guide & Rubbers	636
Runners	626
Screws	
Inner Quarter Moulding.....	638
Nomad Side Moulding	648
Seals, Rear.....	643
Seals, Vent & Vertical	642
Skin Patch Panels.....	565
Stops & Related.....	637-638
to Trunk Panels, Rear	579, 591
Vent	640-642
Windshield	
Center Connector Moulding.....	630
Center Pillar, Convertible	601
Channels , Bottom Gasket.....	636
Custom Tri-Five Shades	692, 708
Dash Garnish Trim.....	147
Electric Wiper Service Booklet.....	663
Frame, Convertible.....	600
Frame Moulding Hardware	
Convertible	180
Gasket Channels	629, 636

Glass	655
Moulding(s) & Related.....	625, 628-630
Pillar	
Screw Set	631
Seals.....	631
Raingear Washer Kit.....	634
Seals	630-631, 696, 703, 707
Slides & Related.....	631-634
Upper Cowl Panel Flange.....	554
Visors.....	555, 628
Wiper	
Center Drive Gaskets.....	634
Knobs	92
Washer Control Cable.....	631
Wing, Air Cleaner Nuts.....	328
Winged Speed Nut	
Fasteners	59
Fasteners & Tool	28, 59
Wiper & Related	631-633
Back Plate.....	92
Electric Motor Service Manual	664
Knobs	92
Motors & Related	632-634
Switch Nut Tool	275
Wire(s)	
Alternator Charge	246
Channels, Door Hinges	617, 624
Conduit, Flexible & Power Window....	624
Disconnect Plugs	238
Grommets	69, 264, 281
Harness(es)	108, 247, 249, 251
Clips	167, 280, 291
Fuel Injection	348
Painless Performance	248
Radiator Support Clip	384
Headlights.....	72
Overdrive Harness Switch Plug	530
Shift Indicator Rods	523
Spark Plug	265
Wiring	
Cold Case Electric Fan.....	377
Connectors	208, 248-249
Diagrams.....	247, 664
Electrical System Books	669
Gauge, Dakota Digital	120
Grommet Set	248
Grommet, Radiator Core Support	384
Harness(es)	
Factory Fit	251
Clips, Inner Fender.....	291, 549
Door Sill Covers & Screws.....	143, 565
Electric Gauge	108
Grommet, Firewall	282
Ignition	262, 266, 272
Insulator.....	369
Lead	399
Looms	263, 266, 273
Mini Stripper Crimper	268
Shield On Steering Column	402
Spark Plug, MSD.....	268
Spark Plug, Universal	273
Support	262
Tie, Brass	308
Wheel Covers & Related	479
Wraps, Powerbraid.....	248
System, Highway Series.....	250
Turn Signal Switch	401
Wonderbar Radio	255
Woody's Hot Rodz.....	602-603

Wraps

Billet Specialties Steering Wheel	394
Powerbraid Wire.....	248
Thermo-Tec Exhaust	360
Wrench(es).....	692
Coil Over Spanner	436
Hose End	301
Lug & Jack Handle.....	167

X

X-Frame Assembly, Convertible	600
XENON Headlights	72

Y

Yokes, Drive Shaft.....	513
-------------------------	-----

Z

Zinc Anode, Radiator	386
Zinc, Motor Oil with	686

This catalog was designed and produced in-house by Danchuk Mfg., Inc. No part of this catalog may be reprinted, reproduced or utilized in any form without the express written permission of Danchuk Mfg., Inc.

**© 2020 Danchuk Mfg, Inc.
All Rights Reserved Printed in the USA**

Come Visit Us in California!

Danchuk is located in Santa Ana, California, off the 55 Freeway.

Shipping & Receiving



the Office



Customer Service



Production



Manufacturing



ADDRESS:
3201 S. STANDARD AVENUE
SANTA ANA, CA 92705

HOURS (PST):
Monday - Friday: 7:00am - 5:00pm
Saturday: 8:00am - 2:00pm

LOCAL PHONE:
(714) 540-4363

*A special thanks to
Jon @ X-treme Apparel,
Phoenix, AZ for our
fabulous Cover Art!*

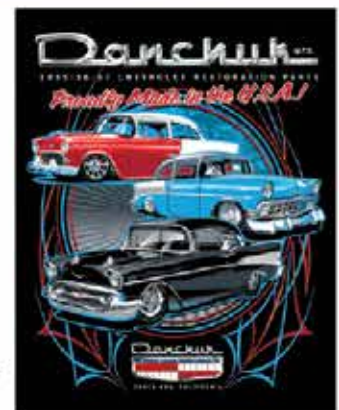

THIS CATALOG WAS DESIGNED AND PRODUCED IN-HOUSE BY DANCHUK MFG., INC. NO PART OF THIS CATALOG MAY BE RE-PRINTED, REPRODUCED OR UTILIZED IN ANY FORM WITHOUT THE EXPRESS WRITTEN PERMISSION OF DANCHUK MFG., INC.

DANCHUK MANUFACTURING INC.
3201 S. STANDARD AVENUE
SANTA ANA, CALIFORNIA 92705

PRESORTED
BOUND PRINTED MATTER
US POSTAGE
PAID
SANTA ANA, CA
PERMIT NO. 4508

Follow us on these Social Media Channels!

DANCHUKUSA     